



EA Engineering, Science, and Technology, Inc., PBC
320 Gold Avenue SW, Suite 1300
Albuquerque, New Mexico 87102
www.eaest.com

March 8, 2024

Mr. Jaben Richards
Ground Water Quality Bureau
New Mexico Environment Department
PO Box 5469
Santa Fe, NM 87502

Dear Mr. Richards:

On behalf of Doña Ana Dairies, Inc., EA Engineering, Science, and Technology, Inc., PBC is submitting this Quarterly Groundwater Monitoring Report for the dairies located in Mesquite, Vado, and Anthony, New Mexico. The report includes the Del Oro Dairy pump and reuse system performance assessment and the quarterly groundwater sampling event conducted to fulfill requirements of the Stage 2 Abatement Plan for Doña Ana Dairies.

Please let me know if you have any questions regarding the information provided in this report.

Sincerely,

A handwritten signature in blue ink that reads "Gina Mullen".

Gina Mullen
Project Manager

A handwritten signature in blue ink that reads "Jay Snyder".

Jay Snyder
Senior Hydrogeologist

Enclosure

Cc: Linda Armstrong, Doña Ana Dairies (electronic)
File



EA Engineering, Science, and Technology, Inc., PBC
320 Gold Avenue SW, Suite 1300
Albuquerque, New Mexico 87102
www.eaest.com

QUARTERLY GROUNDWATER
MONITORING REPORT
DOÑA ANA DAIRIES
MESQUITE, NEW MEXICO

Prepared for:

Doña Ana Dairies
Mesquite, New Mexico

Prepared by:

EA Engineering, Science,
and Technology, Inc., PBC
320 Gold Avenue SW, Suite 1300
Albuquerque, New Mexico 87102

March 2024

EA Project No. 14641-12-00.04
14641-11-00.04

QUARTERLY GROUNDWATER
MONITORING REPORT
DOÑA ANA DAIRIES
MESQUITE, NEW MEXICO

Prepared for:

Doña Ana Dairies
Mesquite, New Mexico

Prepared by:

EA Engineering, Science,
and Technology, Inc., PBC
320 Gold Avenue SW, Suite 1300
Albuquerque, New Mexico



Gina Mullen
Project Manager

March 8, 2024

Date

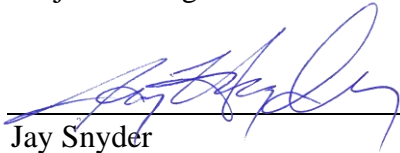

Jay Snyder
Senior Hydrogeologist

March 8, 2024

Date

March 2024

TABLE OF CONTENTS

<u>Section</u>		<u>Page</u>
1.0	INTRODUCTION	1
1.1	Objective and Monitoring Scope	1
1.2	Background	2
2.0	GROUNDWATER MONITORING ACTIVITIES	1
2.1	Monitoring Well Gauging	1
2.2	Groundwater Sampling	1
3.0	GROUNDWATER MONITORING RESULTS	3
3.1	Hydraulic Gradient and Direction of Groundwater Flow	3
3.2	Groundwater Field Parameters	3
3.3	Groundwater Analytical Results	4
3.3.1	Abatement Plan Monitoring Well Analytical Results	4
3.3.2	Abatement Plan and Discharge Plan Analytical Results by Area	4
4.0	CONCLUSION AND RECOMMENDATIONS	7
5.0	REFERENCES	8

LIST OF TABLES

(All Tables Provided Electronically via CD)

Table 1	Summary of Monitoring Well Fluid Gauging Data
Table 2	Summary of Monitoring Well Groundwater Field Parameters
Table 3	Summary of Sample Analytical Methods and Sampling Requirements
Table 4	Abatement Plan Monitoring Well Groundwater Analytical Results
Table 5	Discharge Plan Monitoring Well Groundwater Analytical Results

LIST OF FIGURES

Figure 1	Site Location Map
Figure 2	Potentiometric Surface Map, November 2023, Northern Portion
Figure 3	Potentiometric Surface Map, November 2023, Central Portion
Figure 4	Potentiometric Surface Map, November 2023, Southern Portion, Regional Aquifer
Figure 5	Potentiometric Surface Map, November 2023, Southern Portion, Perched Aquifer
Figure 6	Groundwater Analytical Results, November/December 2023, Northern Portion
Figure 7	Groundwater Analytical Results, November/December 2023, Central Portion
Figure 8	Groundwater Analytical Results, November/December 2023, Southern Portion, Regional Aquifer
Figure 9	Groundwater Analytical Results, November/December 2023, Southern Portion, Perched Aquifer

LIST OF APPENDICES

Appendix A	Del Oro Dairy Pump and Reuse System Performance Assessment
Appendix B	Gauging and Sampling Field Forms (Provided Electronically via CD)
Appendix C	Analytical Laboratory Reports (Provided Electronically via CD)
Appendix D	Hydrographs by Area
Appendix E	Field Parameter Trends by Area
Appendix F	Concentration Trends by Area – Abatement Plan Wells

1.0 INTRODUCTION

On behalf of Doña Ana Dairies (Dairies), EA Engineering, Science, and Technology, Inc., PBC (EA) has prepared this Quarterly Monitoring Report for Doña Ana Dairies located south of Las Cruces, New Mexico (Figure 1). The report was completed in accordance with the *Stage 2 Abatement Plan* and the *Sampling and Analysis Plan, Doña Ana Dairies, Doña Ana County, New Mexico* dated November 7, 2013, and August 11, 2008, respectively, and the *Conceptual Work Plan (CWP)* dated February 1, 2008. All were prepared to satisfy requirements stated in the New Mexico Administrative Code (NMAC), Title 20, Chapter 6, Part 2, Sections 4106 through 4110 (20.6.2.4106 – 20.6.2.4110 NMAC). The Sampling and Analysis Plan was approved by the New Mexico Environment Department (NMED) Ground Water Quality Bureau (GWQB) on September 25, 2008 (NMED 2008). On March 25, 2015, the stipulated agreement to additional requirements to the Dona Ana Dairies Stage 2 Abatement Plan was agreed upon by NMED, the Dairies, and the Rio Valle Concerned Citizens (NMED, Doña Ana Dairies, and Rio Valle Concerned Citizens 2015). The Stage 2 Abatement Plan was approved by NMED by Final Order on April 10, 2015. A Stage 2 Abatement Plan Modification was approved by NMED on April 26, 2022 (NMED 2022). Full document references are provided in Section 5.0.

1.1 Objective and Monitoring Scope

The objectives of this monitoring program are to satisfy the requirements set forth in the Stage 2 Abatement Plan and the Stipulated Agreement and to satisfy the requirements set forth in 20.6.2.4110 NMAC.

The following work was performed to meet the objectives of the monitoring program:

- Representatives from D&H Petroleum and Environmental Services, Inc. (D&H) gauged discharge plan (DP) monitoring wells, abatement plan (AP) monitoring wells, and Anthony Waste Water Treatment Plant (WWTP) wells from November 1, 2023 through November 6, 2023. Organ Dairy wells were gauged by Glorieta Geosciences, Inc. (Glorieta) on November 20, 2023.
- From November 8, 2023, through December 15, 2023, D&H representatives collected groundwater samples from all AP and DP wells that contained sufficient water. Glorieta sampled Organ Dairy wells on November 20, 2023. The samples were analyzed for nitrate (as nitrogen), chloride, total dissolved solids (TDS), and total Kjeldahl nitrogen (TKN). Field parameters including specific conductance, pH, temperature, oxidation reduction potential (ORP), and dissolved oxygen were monitored and recorded on field forms during sampling.

Additionally, a performance assessment was performed on the Del Oro pump and reuse system in compliance with the Stage 2 Abatement Plan Modification Performance Plan for Dona Ana Dairies (EA 2022). The performance assessment is provided in Appendix A.

1.2 Background

In correspondence dated April 7, 2006, NMED required a Stage 1 Abatement Plan for 13 dairies in Doña Ana County, based on analytical results from DP monitoring of on-site compliance monitoring wells that showed concentrations of nitrate, chloride and TDS exceeding ground water standards promulgated in New Mexico Water Quality Control Commission (NMWQCC) Regulations (20.6.2.3103 NMAC). The 13 dairies were:

1. Organ Dairy (Former Daybreak and Del Norte Dairy)
2. Mountain View Dairy
3. Buena Vista I Dairy
4. Bright Star Dairy
5. Dominguez 2 (Former D&J Dairy)
6. Dominguez Dairy
7. Gonzales Dairy
8. Buena Vista Dairy I and II
9. River Valley Dairy
10. Big Sky Dairy
11. Sunset Dairy
12. Desert Land Dairy
13. Del Oro Dairy

On October 30, 2006, the 13 dairies notified NMED that they had reached an agreement to work as a group and submit a joint response to NMED's request (Doña Ana Dairies, 2006). Currently the Doña Ana Dairies (DAD) consortium consists of 9 dairies with the departure from the group by Buena Vista I Dairy in 2011, River Valley Dairy in April 2019, and Gonzalez Dairy in October 2020.

The current DAD consortium is organized geographically into the northern area, central area and southern area. The northern area currently consists of Organ Dairy, Mountain View Dairy, Bright Star Dairy, Dominguez 2 Dairy, and Dominguez Dairy. The northern land application is also included in the northern area of DAD. Buena Vista Dairy and Gonzalez Dairy, though no longer members of the DAD consortium, are located within the northern area. The central area consists of Buena Vista Dairy II, Big Sky Dairy, and Sunset Dairy/Desert Land Dairy. Though no longer a member of the DAD consortium, River Valley Dairy is also located in the central area. The southern area includes only the Del Oro Dairy.

On December 11, 2006, on behalf of the Doña Ana Dairies, Golder Associates Inc. (Golder) submitted a Stage 1 and 2 Abatement Plan Proposal to address impacts to groundwater in the area containing the Dairies (Golder 2006).

The first major deliverable in the Abatement Plan Proposal was an Existing Data Report (EDR), created to combine all existing and historical data and practices of the constituent dairies. The EDR, submitted on February 1, 2008 (Golder 2008a), was intended to satisfy the DAD consortiums' commitment for compilation and submission of existing data identified in the Doña Ana Dairies response (Golder 2006) to the NMED requirement for Stage 1 Abatement Plans. Section 9 of the EDR outlined data gaps identified during the preparation of the report, as well as the actions recommended. To facilitate the discussion of the path forward after the submittal of the EDR and concurrent with the EDR submission, a conceptual work plan (CWP) was prepared (Golder 2008b).

A meeting was held on July 15, 2008 between the DAD consortium, Golder and NMED. During that meeting, plume maps presented in the EDR (Golder 2008a), new monitoring data, and knowledge of monitoring well locations and groundwater chemistry results at adjacent DP-regulated facilities were used to identify data gaps with respect to ground water flow direction and plume delineation. The agreed upon data gaps yielded monitoring well locations (including contingency monitoring well locations) recorded in the meeting minutes (Golder 2008c) and depicted in the Sampling and Analysis Plan (SAP) dated August 8, 2008 (Golder 2008d). The SAP outlined the details of the field operations to be implemented for completion of data gaps, such that a Site Investigation Report (§4106.C.6 NMAC) and Stage 2 Abatement Plan (§4106.D NMAC) could be prepared.

Between February 2008 and December 2008, quarterly groundwater gauging was conducted concurrent to discussions with NMED at the DAD consortium to determine the current and historical site groundwater gradient.

In May 2009, field work was conducted as outlined in the SAP and ten AP monitoring wells (DAD-01 through DAD-10) were installed. In July 2009, the Site Investigation Report was submitted to the NMED (EA 2009).

On February 9, 2012, the Final Site Investigation Report was submitted to NMED (EA 2012a). The report summarized field activities that occurred from October 10 through October 14, 2011, and November 10 through 18, 2011, during which eleven soil borings were advanced at the site and converted into monitoring wells DAD-12 through DAD-14, DAD-16 through DAD-22, and DP well 177-03A.

On August 16, 2012, soil boring/monitoring well DAD-15 was installed and on August 20, 2012, well DAD-15 was sampled. An addendum to the Final Site Investigation Report was submitted to NMED on September 9, 2012 (EA 2012b), which summarized DAD-15 field activities.

A Stage 2 Abatement Plan was submitted to NMED on March 13, 2013 (EA 2013a). Based on an NMED response in August 2013, a Revision to the Stage 2 Abatement Plan was submitted on November 7, 2013 (EA 2013b).

On March 25, 2015, the stipulated agreement to additional requirements to the Doña Ana Dairies Stage 2 Abatement Plan was agreed to by NMED Doña Ana Dairies, and the Rio Valle Concerned Citizens. On April 10, 2015, the Stage 2 Abatement Plan with the stipulated agreement was approved by NMED by Final Order (NMED 2015).

EA began implementation of the Stage 2 Abatement Plan and stipulated agreement as directed by the Final Order in December 2015. To meet objectives, four monitoring wells were installed (DAD-23 through DAD-26) and Del Oro Dairy discharge plan (DP) well 692-01 was plugged and abandoned. Details on implementation of these tasks are included *Stage 2 Implementation and Quarterly Groundwater Monitoring Report* dated July 2016 (EA 2016).

In accordance with the approved Stage 2 Abatement Plan and stipulated agreement, a baseline compound specific isotope analysis for nitrogen 14 and nitrogen 15 ($^{15}\text{N}/^{14}\text{N}$ [$\delta^{15}\text{N}$]) and total organic carbon (TOC) was completed for 16 monitoring wells in spring of 2016. Additionally,

existing conditions concentrations were recalculated for the contaminants of concern. Results of these analyses are presented in the *Stage 2 Implementation and Quarterly Groundwater Monitoring Report* dated July 2016 (EA 2016). A five-year review containing results of repeated compound specific isotope analysis sampling and recalculated existing conditions concentrations was submitted to NMED in December 2020 (EA 2020a).

Contaminant concentration trend analysis as well as geospatial analysis to evaluate changes in plume behavior are required on an annual basis and are provided in the annual report. Additionally, the results of the annual sampling of irrigation and supply wells and concentration trends of analytes in AP and DP wells are provided in the annual report.

A Stage 2 Abatement Plan Modification proposal was submitted to NMED on August 10, 2018, to address plume instability in the perched aquifer nitrate plume at Del Oro Dairy. Following discussions with NMED, a revised Stage 2 Abatement Plan Modification proposal was submitted on May 1, 2019. A public meeting to discuss the plan was held in Anthony, New Mexico on May 17, 2019. The Stage 2 Abatement Plan Modification proposal was revised based on additional input from NMED and the public and submitted on July 26, 2019 (EA 2019). Public notice for the proposal was initiated on October 23, 2019, and closed on December 31, 2019. An addendum to the Stage 2 Abatement Plan Modification proposal was submitted on July 13, 2020 (EA 2020b). A revised addendum to the Stage 2 Abatement Plan Modification proposal was submitted on July 13, 2021, based on additional comments from the public (EA 2021). An additional virtual townhall meeting was held on December 15, 2021, that presented the current proposal. The performance plan was submitted to NMED on February 15, 2022 (EA 2022). NMED approved the Stage 2 Abatement Plan Modification for Doña Ana Dairies (EA 2019), the accompanying Stage 2 Abatement Plan Addendum for Reuse of Pumped Groundwater at Del Oro Dairy (EA 2021), and the Stage 2 Abatement Plan Modification Performance Plan (EA 2022) on April 26, 2022 (NMED 2022). Implementation is detailed in the Stage 2 Abatement Plan Modification Completion Report (EA 2023). The quarterly performance assessment of the Del Oro Dairy pump and reuse system, as required by Stage 2 Abatement Plan Modification Performance Plan (EA 2022) is provided in Appendix A.

2.0 GROUNDWATER MONITORING ACTIVITIES

Groundwater monitoring activities included gauging AP monitoring wells, DP monitoring wells for dairies that are a part of the DAD consortium, and the Anthony WWTP monitoring wells. Groundwater samples were collected from AP monitoring wells and DP monitoring wells for dairies that are a part of the DAD consortium. The DAD consortium currently consists of the following dairies: Big Sky, Bright Star, Buena Vista II, Del Oro, Dominguez, Dominguez 2, Mountain View, Organ, and Sunset/Desert Land. Groundwater samples were analyzed for nitrate, chloride, TDS, and TKN. The resulting data from this groundwater monitoring event are compiled and presented below.

2.1 Monitoring Well Gauging

From November 1, 2023, through November 6, 2023, representatives from D&H gauged DP monitoring wells, AP monitoring wells, and Anthony WWTP wells with an electronic water level indicator. Organ Dairy wells were gauged by Glorieta on November 20, 2023. Table 1 provides a summary of the groundwater gauging data collected from the monitoring network. Data obtained during gauging are shown on potentiometric surface maps included as Figures 2, 3, 4, and 5. Well gauging field forms are available in Appendix B.

2.2 Groundwater Sampling

D&H collected groundwater samples from all AP monitoring wells with sufficient water from December 5, 2023 through December 15, 2023. Groundwater sampling from AP wells was accomplished with new, disposable bailers and twine. Three well casing volumes were purged unless the well contained insufficient water.

D&H collected groundwater from the DP wells from November 8, 2023 through December 4, 2023. Glorieta collected groundwater from Organ Dairy DP wells on November 20, 2023. Prior to sampling, all DP wells were purged of three well casing volumes, if practicable, by (1) hand-bailing with new, disposable bailers and twine, (2) pumping with a submersible pump and new polyethylene tubing, or (3) pumping with a dedicated pump and new polyethylene tubing. Several DP wells were dry or contained insufficient water for sampling. Organ Dairy wells 126-04, 126-05, 126-07, and 126-09, Mountain View Dairy well 70-02, and Dominguez 2 Dairy wells 42-10 and 42-12 contained insufficient water and were not sampled. Bright Star well 340-02, and Del Oro Dairy well 692-04 were dry. Sunset/Desert Land Dairy well 257-03 was not sampled due to an unknown blockage in the well.

The wells were sampled from historically clean to dirty to the extent possible to minimize cross-contamination potential. All non-dedicated or disposable equipment was decontaminated between wells with an Alconox™ solution to further ensure sample quality. All meters were calibrated and/or checked with standards in accordance with the manufacturer's specifications prior to daily use. Purge water was ground discharged.

When sufficient water was available, field parameters including specific conductance, temperature, pH, ORP, and dissolved oxygen were monitored using a water quality meter and data were recorded on field forms. Dissolved oxygen and ORP were only measured in the first

set of readings. Field parameters from August 2015 to present are summarized in Table 2. The sampling field forms are presented in Appendix B.

All groundwater samples were collected immediately after purging. Sampling was either accomplished by carefully pouring groundwater from the bailer into the sample containers or by pumping groundwater through new polyethylene tubing into the sample container. Sample containers were provided by Eurofins Environment Testing South Central, LLC (Eurofins). Container size, type, sample preservatives, analytical methods, and holding times are specified in Table 3. All samples were preserved in accordance with method requirements, labeled, then immediately cooled to <6°C with ice and delivered under chain-of-custody to Eurofins in Albuquerque, New Mexico. All analytical laboratory reports are provided in Appendix C.

3.0 GROUNDWATER MONITORING RESULTS

3.1 Hydraulic Gradient and Direction of Groundwater Flow

During the past quarter, groundwater was present beneath the site at depths ranging from 14.88 feet below top-of-casing (ft btoc) in Sunset well 257-03 to 137.16 ft btoc in Dominguez 2 well 42-12. Groundwater was encountered at shallower depths near the Mesquite Drain and at greater depths near I-10 where the topographic elevation increases.

AP monitoring well DAD-25 may have been completed in a perched aquifer, as groundwater elevations have consistently measured several feet higher than groundwater elevations in surrounding wells. As a result, groundwater elevation data from this well is not used in contouring for the central area potentiometric surface map.

Potentiometric surface maps of groundwater elevation were completed using monitoring well gauging data for the northern, central, and southern areas (perched and regional aquifers) of the Dairies. Groundwater elevation data are provided in Table 1 and potentiometric surface maps are provided as Figures 2 through 5. Hydrographs were completed for select monitoring wells in each area and are provided in Appendix D. On average, regional aquifer groundwater elevations fell by 0.44 feet in the northern, area and by 0.41 feet in the southern area compared to the previous quarter. The regional aquifer groundwater elevations changes were inconsistent in the central area. The northern portion of the central area had risen in groundwater elevation of around a half foot; groundwater elevations fell by up to 0.88 ft in the southern portion of the central area. In the southern perched aquifer, groundwater elevations decreased by an average of 0.18 feet.

During the most recent gauging event, groundwater flow direction of the regional aquifer was to the southeast except in the middle portion of the northern area where groundwater flowed to the east-northeast. Flow direction in the southern perched aquifer was to the south.

The hydraulic gradient across the Dairies in the northern is 0.001 ft/ft, central is 0.0003 ft/ft, and southern portions of the regional aquifer was approximately 0.001 ft/ft and the hydraulic gradient in the perched aquifer in the southern area was approximately 0.004 ft/ft.

3.2 Groundwater Field Parameters

Field parameters from the most recent monitoring event (specific conductance, pH, temperature, ORP, and dissolved oxygen) were recorded on the sampling field forms provided in Appendix B and are summarized in Table 2. Specific conductance, dissolved oxygen, and ORP trends for select wells are presented in Appendix E. Though dissolved oxygen and ORP measurements from wells containing a dedicated pump were recorded, these measurements are not considered representative of aquifer conditions. As noted in Section 2.2, dissolved oxygen and ORP are only recorded in the first set of readings. This is because hand bailing agitates the aquifer and the ORP and dissolved oxygen measurements are not considered representative once agitation begins.

3.3 Groundwater Analytical Results

3.3.1 Abatement Plan Monitoring Well Analytical Results

Groundwater analyte concentrations were below the 10 milligrams per liter (mg/L) NMWQCC standard for nitrate as nitrogen in 11 of the 26 AP monitoring wells sampled. AP monitoring well DAD-20 was unable to be sampled due to well damage. The well is located on Anthony Waste Water Treatment Plant property and was damaged along with the protective bollards around it. Groundwater collected from the following 15 AP wells had nitrate concentrations at or above the standard: DAD-01, DAD-07, DAD-08, DAD-09, DAD-11 (vertical delineation well), DAD-12 (vertical delineation well), DAD-13, DAD-14, DAD-15, DAD-18, DAD-19 (vertical delineation well), DAD-21, DAD-22, DAD-23, and DAD-26.

Nitrate concentrations decreased or were the same in groundwater collected from AP wells DAD-01, DAD-02, DAD-03, DAD-04, DAD-05, DAD-08, DAD-12, DAD-15, DAD-17, DAD-19 (vertical delineation well), DAD-21, DAD-23, DAD-26, and DAD-27 compared to the previous sampling event. The largest decrease in nitrate concentration was observed in well DAD-21, which decreased from 35 mg/L in September 2023 to 28 mg/L in December 2023. The largest nitrate concentration increase was observed in groundwater collected from well DAD-13, where concentrations increased from 11 mg/L in August 2023 to 26 mg/L in December 2023. During this sampling event, nitrate concentrations in groundwater collected from AP wells ranged from 84 mg/L in well DAD-14 to below the laboratory reporting limit of 1.0 mg/L in wells DAD-03, DAD-04, DAD-05, and DAD-17. The nitrate concentrations in DAD-07, DAD-11 (vertical delineation well) and DAD-14 continue to increase.

Both chloride and TDS concentrations equaled or exceeded their respective NMWQCC standards in most AP wells. Exceptions include well DAD-05 where chloride was below standard, and wells DAD-06R and DAD-17, where both chloride and TDS groundwater concentrations were below the 250 mg/L and 1,000 mg/L standards, respectively. The highest chloride concentrations in the AP wells were in wells DAD-08 and DAD-14, where groundwater concentrations were 1,400 mg/L. The highest TDS concentration in the AP wells were found in well DAD-15, where groundwater concentration was 5,060 mg/L. This concentration is anomalously high and the result was qualified for exceeding hold time. TDS concentrations at this well will be observed during up-coming monitoring events.

Table 4 and Figures 6 through 9 present the analytical results for AP monitoring wells. Analytical laboratory reports are provided in Appendix C. Nitrate, chloride, and TDS concentration trends for select AP wells are presented by area in Appendix F.

3.3.2 Abatement Plan and Discharge Plan Analytical Results by Area

DP groundwater analytical results are presented in Table 5. Nitrate, chloride, and TDS concentration trends for the AP wells by area are presented in Appendix F. Analytical data for all sampled wells are plotted on Figures 6 through 9. Analytical laboratory reports are included in Appendix C. Discussions of upgradient/downgradient conditions in the following section are based on groundwater flow directions presented in Section 3.1. The following discussions summarize the results by area at the Dairies.

Northern Portion

Groundwater collected from upgradient well 86/340-01 (located north of the abatement area) has been below the nitrate NMWQCC standard of 10 mg/L since February 2018; historically, groundwater concentrations in this well were consistently above the nitrate standard. Northern Land Application Area well 70/86/340-01, located at the northern-most boundary of the abatement area, contained groundwater above the nitrate standard at a concentration of 33 mg/L. Organ Dairy well 126-12, Dominguez Dairy 2 well 42-08, and Dominguez Dairy 624-02 delineate the western edge of the plume. The nitrate plume is defined to the east by Dominguez Dairy well 42-11 and AP well DAD-01, although during this sampling event, nitrate concentrations were reported in AP well DAD-01 just above the standard at 11 mg/L. DAD-13 usually serves as an eastern delineation well with a nitrate concentration just above the standard; however, the December 2023 sample had an anomalously high concentration of 26 mg/L. EA will continue to monitor this well for increasing trends. Southern plume delineation is provided by AP well DAD-02. The highest nitrate concentration in the northern portion was observed in DAD-14 with a concentration of 84 mg/L.

The chloride and TDS concentrations in DP wells were at or above their standards in all wells sampled within the northern portion of the Dairies. The highest concentrations of chloride and TDS were observed in Northern Land Application area well 70/86/340-01 at concentrations of 1,900 mg/L and 6,290 mg/L, respectively.

Central Portion

The northern extent of the central portion nitrate plume is defined by Buena Vista Dairy II well 74-03 where the nitrate concentration was not detected above the laboratory reporting limit. The southern extent is defined by Las Cruces Community Farms (formerly McAnally Enterprises) well MW-4, where nitrate was detected at a concentration of 1.1 mg/L in November 2023. The eastern edge of the nitrate plume is currently delineated by AP well DAD-06R, at a concentration of 9.6 mg/L. Historically, the eastern extent of the plume was defined by wells DAD-07 and DAD-15. In the most recent sampling event, nitrate concentrations in groundwater collected from these wells exceeded the standard with concentrations of 43 mg/L and 18 mg/L, respectively. The western extent is defined by Buena Vista Dairy well 74-02 and AP wells DAD-16 and DAD-05; nitrate was detected below the NMWQCC standard in DP well 74-02 at 7.8 mg/L, and in AP well DAD-16, at 1.1 mg/L. Nitrate was not detected above the reporting limit of 1.0 mg/L in AP well DAD-05. The highest nitrate concentration in the central portion was 77 mg/L, observed in Big Sky Dairy well 833-07.

Chloride and TDS concentrations were generally at or above standards in wells within the central portion of the Dairies. Chloride was below the standard in Buena Vista Dairy II well 74-03 (220 mg/L) and in AP wells DAD-05 (180 mg/L), DAD-06R (98 mg/L) and DAD-17 (100 mg/L). TDS was below the standard in AP wells DAD-06R (347 mg/L) and DAD-17 (750 mg/L). The highest chloride concentration was observed at AP well DAD-08, Big Sky Dairy well 833-02, and Las Cruces Community Farms MW-4 at 1,400 mg/L. The highest TDS concentration of 5,060 mg/L was detected at AP well DAD-15.

Southern Portion – Regional Aquifer

Wells completed in the regional aquifer in the southern portion of the dairies include AP well DAD-10 and Del Oro wells 692-05 through 692-10 (Figure 8). All of the groundwater collected from wells in the regional aquifer contained nitrate below the NMWQCC standard except for Del Oro well 692-05 (19 mg/L).

Chloride concentrations were detected above the NMWQCC standard and ranged from 380 mg/L in AP well DAD-10 to 660 mg/L in Del Oro Dairy well 692-10. TDS concentrations ranged from 1,380 mg/L in DP well 692-08 to 1,610 mg/L in Del Oro Dairy wells 692-05 and 692-10.

Southern Portion – Perched Aquifer

Wells completed in the perched aquifer in the southern portion that are sampled on a quarterly basis by DAD include wells 692-02, 629-04, DAD-09, DAD-20, DAD-21, DAD-22, DAD-26, and DAD-27 (Figure 9). Groundwater nitrate concentrations were above the standard in all monitoring wells in the perched aquifer except downgradient well DAD-27 (6.4 mg/L). The highest nitrate concentration was detected at AP well DAD-09 (33 mg/L). The concentration of nitrate in groundwater collected from downgradient AP wells DAD-22 and DAD-26 are 15 mg/L and 14 mg/L, respectively. The nitrate plume is delineated to the southwest by AP well DAD-27. The nitrate concentration has remained relatively steady in DAD-27. Additionally, the nitrate concentration decreased in Del Oro well 692-02 from 31 mg/L in August 2023 to 13 mg/L in November 2023. At Del Oro Dairy the nitrate concentrations appear to be decreasing because of the pump and reuse system within the perched aquifer. The performance assessment of the system is provided in Appendix A

Chloride concentrations in the perched aquifer monitoring wells ranged from 430 mg/L in AP well DAD-09 to 1,000 mg/L in AP well DAD-26. TDS in the perched aquifer ranged from 1,720 mg/L in Del Oro well 692-02 to 3,070 mg/L in AP well DAD-26.

4.0 CONCLUSION AND RECOMMENDATIONS

This groundwater monitoring event included the gauging of all DP and AP wells and sampling of all wells that contained sufficient water. Based on the data collected, the following conclusions and recommendations are presented:

- Depth to groundwater ranged from 14.88 feet btoc in Sunset well 257-03 to 137.16 ft btoc in Dominguez 2 well 42-12.
- On average, regional aquifer groundwater elevations fell by 0.44 feet in the northern area and by 0.41 feet in the southern area compared to the previous quarter. The regional aquifer groundwater elevations rose by an average of 0.04 feet in the central area relative to last quarter. In the southern perched aquifer, groundwater elevations rose by an average of 0.18 feet.
- During the most recent gauging event, groundwater flow direction in the northern area was to the southeast except in the middle portion of the northern area where groundwater flowed to the east-northeast. Groundwater flow direction in the central and southern regional aquifers was generally to the southeast. Flow direction in the southern perched aquifer was to the south.
- The hydraulic gradient across the Dairies in the northern is 0.001 ft/ft, central is 0.0003 ft/ft, and southern portions of the regional aquifer was approximately 0.001 ft/ft and the hydraulic gradient in the perched aquifer in the southern area was approximately 0.004 ft/ft.
- Nitrate was below the NMWQCC standard of 10 mg/L in 11 of the 26 groundwater samples collected from the AP wells.
- Chloride and TDS generally remain at or above standards in regional aquifer wells upgradient of the northern, central, and southern portions of the plumes at the Dairies.
- At Del Oro Dairy the nitrate concentrations appear to be decreasing because of the pump and reuse system within the perched aquifer.

5.0 REFERENCES

- Doña Ana Dairies. 2006. Letter Regarding Agreement for Joint Stage 1 and Stage 2 Abatement Plan and Storm Water and Wastewater Pond Upgrades. Letter from Mr. Michael Weatherly, Chairman, Doña Ana Dairies, to Mr. William Olson, Chief, Ground Water Quality Bureau. 30 October.
- EA. 2009. *Site Investigation Report, Doña Ana Dairies, Mesquite, New Mexico*. 16 July 16.
- EA. 2012a. *Final Site Investigation Report, Doña Ana Dairies, Mesquite, New Mexico*. February 9.
- EA. 2012b. *Final Site Investigation Report Addendum, Doña Ana Dairies, Mesquite, New Mexico*. September 9.
- EA. 2013a. *Stage 2 Abatement Plan, Doña Ana Dairies, Mesquite, New Mexico*. March 13.
- EA. 2013b. *Stage 2 Abatement Plan, Revision 01, Doña Ana Dairies, Mesquite, New Mexico*. November 7.
- EA. 2016. *Stage 2 Implementation and Quarterly Groundwater Monitoring Report, Doña Ana Dairies, Mesquite, New Mexico*. July 26.
- EA. 2019. *Stage 2 Abatement Plan Modification Proposal and DAD-06 Monitoring Well Rehabilitation for Doña Ana Dairies, Doña Ana County, New Mexico, Revision 02*. July 26.
- EA. 2020a. *Five-Year Evaluation and Quarterly Groundwater Monitoring Report, Doña Ana Dairies, Mesquite, New Mexico*. December 20.
- EA. 2020b. *S2AP Addendum for Reuse of Pumped Groundwater, Revision 01, Del Oro Dairy, Anthony, New Mexico*. July 15.
- EA. 2021. *Stage 2 Abatement Plan Addendum for Reuse of Pumped Groundwater, Revision 02, Del Oro Dairy, Anthony, New Mexico*. July.
- EA. 2022. *Stage 2 Abatement Plan Modification Performance Plan for Doña Ana Dairies*. February 15.
- EA. 2023. *Stage 2 Abatement Plan Modification Completion Report for Doña Ana Dairies (Del Oro Dairy), Anthony, New Mexico*. May 16.
- Golder Associates, Inc. (Golder). 2006. *Stage 1 and 2 Abatement Plan Proposal, prepared for New Mexico Environment Department, Remediation Oversight Section, on behalf of Doña Ana Dairies*. December 11.
- Golder. 2008a. *Existing Data Report and Conceptual Work Plan, Doña Ana Dairies, Mesquite, New Mexico*. February 1.

- Golder. 2008b. Conceptual Work Plan. Doña Ana Dairies, Mesquite, New Mexico. February 1.
- Golder. 2008c. Notes for the Meeting Regarding New Monitoring Well Installation. Meeting Participants: Doña Ana Dairy representative, DAD technical representatives, and NMED staff. July 28.
- Golder. 2008d. Sampling and Analysis Plan. Doña Ana Dairies, Mesquite, New Mexico. August 11.
- New Mexico Environment Department (NMED). 2008. Approval of Sampling and Analysis Plan for the Doña Ana Dairies, Stage 1 Abatement Plan, Doña Ana County, New Mexico. September 25.
- NMED. 2015. Approval of Stage 2 Abatement Plan Proposal for Doña Ana Dairies. Final Order from Mr. Ryan Flynn, Secretary, Ground Water Quality Bureau. April 10.
- NMED. 2022. Stage 2 Abatement Plan Modification Approval for Dona Ana Dairies. April 26.
- NMED, Doña Ana Dairies, and Rio Valle Concerned Citizens. 2015. Stipulated Agreement, Dona Ana Dairies Stage 2 Abatement Plan. March 25.

TABLES

(Provided in Electronic Format via CD Located on Front Cover of Report)

**TABLE 1. SUMMARY OF MONITORING WELL FLUID GAUGING DATA
DONA ANA DAIRIES, DONA ANA COUNTY, NEW MEXICO**

Monitoring Well	Date Measured	Northing ^a	Easting ^a	Casing Elevation ^b	Depth to Water ^c	Ground Water Elevation ^b
NORTHERN AREA						
Northern Land Application Area						
70-03	1-Nov-2023	424580.78	1510233.88	3871.43	60.58	3810.85
	2-Aug-2023				60.01	3811.42
	1-May-2023				59.11	3812.32
	2-Feb-2023				59.25	3812.18
	1-Nov-2022				60.10	3811.33
	1-Aug-2022				60.07	3811.36
	2-May-2022				59.10	3812.33
	7-Feb-2022				58.25	3813.18
	1-Nov-2021				58.71	3812.72
	4-Aug-2021				58.18	3813.25
	3-May-2021				57.34	3814.09
	10-Feb-2021				56.98	3814.45
	2-Nov-2020				57.56	3813.87
	10-Aug-2020				58.02	3813.41
	11-May-2020				57.18	3814.25
	4-Feb-2020				56.95	3814.48
	8-Nov-2019				57.10	3814.33
	1-Aug-2019				58.39	3813.04
	8-May-2019				57.97	3813.46
	19-Feb-2019				56.90	3814.53
	12-Nov-2018				57.16	3814.27
	6-Aug-2018				58.05	3813.38
	17-May-2018				57.26	3814.17
	5-Feb-2018				56.16	3815.27
	6-Nov-2017				56.89	3814.54
	8-Aug-2017				57.90	3813.53
	15-May-2017				58.20	3813.23
	6-Feb-2017				57.09	3814.34
	7-Nov-2016				58.05	3813.38
	15-Aug-2016				58.74	3812.69
	16-May-2016				58.50	3812.93
	9-Feb-2016				57.37	3814.06
	6-Nov-2015				58.03	3813.40
	5-Aug-2015				58.45	3812.98
	6-May-2015				57.82	3813.61
	5-Feb-2015				56.55	3814.88
	5-Nov-2014				57.25	3814.18
	12-Aug-2014				57.24	3814.19
	12-May-2014				56.58	3814.85
	12-Feb-2014				55.26	3816.17
	6-Nov-2013				55.93	3815.50
	6-Aug-2013				54.52	3816.91
	7-May-2013				53.87	3817.56
	7-Feb-2013				53.46	3817.97
	24-Oct-2012				54.05	3817.38
	30-Jul-2012				53.70	3817.73
	23-Apr-2012				52.84	3818.59
	30-Jan-2012				51.41	3820.02
	8-Dec-2011				51.49	3819.94
	19-Jul-2011				50.77	3820.66
	20-Apr-2011				49.69	3821.74
	17-Jan-2011				48.70	3822.73
	14-Sep-2010				49.02	3822.41
	24-Jun-2010				48.99	3822.44
	22-Mar-2010				48.90	3822.53
	8-Dec-2009				48.72	3822.71
	28-Aug-2009				49.21	3822.22
	26-May-2009				48.91	3822.52
	11-Dec-2008				48.02	3823.41
	28-Sep-2008				48.06	3823.37
	11-Jun-2008				49.20	3822.23
	5-Feb-2008				47.95	3823.48
	14-Nov-2007				48.10	3823.33
	12-Sep-2007				48.70	3822.73

**TABLE 1. SUMMARY OF MONITORING WELL FLUID GAUGING DATA
DONA ANA DAIRIES, DONA ANA COUNTY, NEW MEXICO**

Monitoring Well	Date Measured	Northing ^a	Easting ^a	Casing Elevation ^b	Depth to Water ^c	Ground Water Elevation ^b
70/86/340-01	1-Nov-2023	427320.92	1508461.05	3866.77	54.48	3812.29
	2-Aug-2023				54.78	3811.99
	1-May-2023				54.00	3812.77
	2-Feb-2023				53.05	3813.72
	1-Nov-2022				53.74	3813.03
	1-Aug-2022				53.36	3813.41
	2-May-2022				52.69	3814.08
	7-Feb-2022				51.94	3814.83
	1-Nov-2021				52.33	3814.44
	4-Aug-2021				51.76	3815.01
	3-May-2021				51.18	3815.59
	10-Feb-2021				49.90	3816.87
	2-Nov-2020				51.00	3815.77
	10-Aug-2020				51.46	3815.31
	11-May-2020				51.15	3815.62
	4-Feb-2020				50.20	3816.57
	8-Nov-2019				50.44	3816.33
	1-Aug-2019				51.52	3815.25
	8-May-2019				51.31	3815.46
	19-Feb-2019				50.16	3816.61
	12-Nov-2018				50.26	3816.51
	6-Aug-2018				50.70	3816.07
	17-May-2018				50.25	3816.52
	5-Feb-2018				49.10	3817.67
	6-Nov-2017				49.58	3817.19
	8-Aug-2017				50.35	3816.42
	15-May-2017				51.40	3815.37
	6-Feb-2017				50.12	3816.65
	7-Nov-2016				51.02	3815.75
	15-Aug-2016				51.56	3815.21
	16-May-2016				51.48	3815.29
	9-Feb-2016				50.22	3816.55
	6-Nov-2015				51.02	3815.75
	5-Aug-2015				51.22	3815.55
	6-May-2015				50.90	3815.87
	5-Feb-2015				49.68	3817.09
	5-Nov-2014				50.67	3816.10
	12-Aug-2014				50.38	3816.39
	12-May-2014				49.94	3816.83
	12-Feb-2014				48.95	3817.82
	6-Nov-2013				49.21	3817.56
	6-Aug-2013				46.44	3820.33
	7-May-2013				46.79	3819.98
	7-Feb-2013				46.49	3820.28
	24-Oct-2012				47.30	3819.47
	30-Jul-2012				46.84	3819.93
	23-Apr-2012				45.91	3820.86
8-Dec-2011	45.17	3821.60				
19-Jul-2011	44.49	3822.28				
20-Apr-2011	43.15	3823.62				
17-Jan-2011	42.00	3824.77				
14-Sep-2010	41.79	3824.98				
24-Jun-2010	42.67	3824.10				
22-Mar-2010	42.21	3824.56				
8-Dec-2009	42.02	3824.75				
28-Aug-2009	42.39	3824.38				
26-May-2009	42.33	3824.44				
11-Dec-2008	41.15	3825.62				
28-Sep-2008	41.58	3825.19				
11-Jun-2008	42.31	3824.46				
5-Feb-2008	41.07	3825.70				
14-Nov-2007	41.38	3825.39				
12-Sep-2007	41.46	3825.31				

**TABLE 1. SUMMARY OF MONITORING WELL FLUID GAUGING DATA
DONA ANA DAIRIES, DONA ANA COUNTY, NEW MEXICO**

Monitoring Well	Date Measured	Northing ^a	Easting ^a	Casing Elevation ^b	Depth to Water ^c	Ground Water Elevation ^b
86/340-01	1-Nov-2023	432021.33	1503216.90	3876.14	60.66	3815.48
	2-Aug-2023				60.52	3815.62
	1-May-2023				60.31	3815.83
	2-Feb-2023				59.55	3816.59
	1-Nov-2022				60.05	3816.09
	1-Aug-2022				60.10	3816.04
	2-May-2022				59.20	3816.94
	7-Feb-2022				58.41	3817.73
	1-Nov-2021				58.78	3817.36
	4-Aug-2021				58.01	3818.13
	3-May-2021				57.21	3818.93
	10-Feb-2021				56.92	3819.22
	2-Nov-2020				57.08	3819.06
	10-Aug-2020				56.96	3819.18
	11-May-2020				57.00	3819.14
	4-Feb-2020				56.41	3819.73
	8-Nov-2019				56.83	3819.31
	1-Aug-2019				57.87	3818.27
	8-May-2019				57.95	3818.19
	19-Feb-2019				56.61	3819.53
	12-Nov-2018				57.17	3818.97
	6-Aug-2018				56.98	3819.16
	17-May-2018				57.00	3819.14
	5-Feb-2018				55.09	3821.05
	6-Nov-2017				55.91	3820.23
	8-Aug-2017				57.30	3818.84
	15-May-2017				58.13	3818.01
	6-Feb-2017				56.49	3819.65
	7-Nov-2016				57.58	3818.56
	15-Aug-2016				58.36	3817.78
	16-May-2016				58.48	3817.66
	9-Feb-2016				56.93	3819.21
	6-Nov-2015				57.83	3818.31
	5-Aug-2015				57.73	3818.41
	6-May-2015				57.74	3818.40
	5-Feb-2015				56.32	3819.82
	5-Nov-2014				57.31	3818.83
	12-Aug-2014				57.28	3818.86
	12-May-2014				57.04	3819.10
	12-Feb-2014				55.10	3821.04
6-Nov-2013	55.78	3820.36				
6-Aug-2013	53.29	3822.85				
7-May-2013	52.65	3823.49				
7-Feb-2013	52.31	3823.83				
24-Oct-2012	53.16	3822.98				
30-Jul-2012	52.70	3823.44				
23-Apr-2012	52.20	3823.94				
30-Jan-2012	51.10	3825.04				
8-Dec-2011	51.20	3824.94				
19-Jul-2011	50.36	3825.78				
20-Apr-2011	48.91	3827.23				
17-Jan-2011	47.00	3829.14				
14-Sep-2010	47.63	3828.51				
24-Jun-2010	48.22	3827.92				
22-Mar-2010	47.66	3828.48				
8-Dec-2009	47.39	3828.75				
28-Aug-2009	47.75	3828.39				
26-May-2009	47.86	3828.28				
11-Dec-2008	46.68	3829.46				
28-Sep-2008	47.44	3828.70				
11-Jun-2008	48.11	3828.03				
5-Feb-2008	46.68	3829.46				
14-Nov-2007	47.11	3829.03				
12-Sep-2007	47.85	3828.29				

**TABLE 1. SUMMARY OF MONITORING WELL FLUID GAUGING DATA
DONA ANA DAIRIES, DONA ANA COUNTY, NEW MEXICO**

Monitoring Well	Date Measured	Northing ^a	Easting ^a	Casing Elevation ^b	Depth to Water ^c	Ground Water Elevation ^b
Organ Dairy (Formerly known as Del Norte Dairy and Daybreak Dairy)						
126-04	20-Nov-2023	423258.23	1510546.24	3850.31	38.09	3812.22
	27-Aug-2023				38.05	3812.26
	24-May-2023				38.00	3812.31
	11-Jan-2023				37.62	3812.69
	8-Nov-2022				38.05	3812.26
	17-Aug-2022				38.00	3812.31
	5-May-2022				37.41	3812.90
	24-Feb-2022				36.20	3814.11
	9-Nov-2021				36.75	3813.56
	11-Aug-2021				36.60	3813.71
	4-May-2021				35.85	3814.46
	9-Feb-2021				34.95	3815.36
	10-Nov-2020				35.70	3814.61
	12-Aug-2020				36.13	3814.18
	11-May-2020				35.98	3814.33
	4-Feb-2020				35.35	3814.96
	8-Nov-2019				35.44	3814.87
	1-Aug-2019				36.75	3813.56
	8-May-2019				36.30	3814.01
	19-Feb-2019				35.32	3814.99
	12-Nov-2018				35.56	3814.75
	6-Aug-2018				36.34	3813.97
	17-May-2018				35.75	3814.56
	5-Feb-2018				34.67	3815.64
	6-Nov-2017				35.47	3814.84
	7-Aug-2017				36.60	3813.71
	15-May-2017				36.60	3813.71
	6-Feb-2017				35.61	3814.70
	7-Nov-2016				36.52	3813.79
	15-Aug-2016				37.28	3813.03
	16-May-2016				37.06	3813.25
	9-Feb-2016				38.20	3812.11
	5-Nov-2015				36.51	3813.80
	5-Aug-2015				37.00	3813.31
	6-May-2015				36.30	3814.01
	5-Feb-2015				35.06	3815.25
	5-Nov-2014				35.62	3814.69
	12-Aug-2014				35.61	3814.70
	12-May-2014				34.98	3815.33
	12-Feb-2014				33.79	3816.52
6-Nov-2013	34.32	3815.99				
6-Aug-2013	32.93	3817.38				
7-May-2013	32.01	3818.30				
7-Feb-2013	32.05	3818.26				
24-Oct-2012	32.58	3817.73				
30-Jul-2012	32.23	3818.08				
23-Apr-2012	31.46	3818.85				
26-Jan-2012	30.89	3819.42				
8-Dec-2011	30.84	3819.47				
19-Jul-2011	30.26	3820.05				
20-Apr-2011	29.09	3821.22				
17-Jan-2011	28.20	3822.11				
14-Sep-2010	28.60	3821.71				
24-Jun-2010	28.21	3822.10				
22-Mar-2010	28.33	3821.98				
8-Dec-2009	28.17	3822.14				
28-Aug-2009	28.50	3821.81				
26-May-2009	28.30	3822.01				
11-Dec-2008	27.56	3822.75				
27-Sep-2008	27.96	3822.35				
10-Jun-2008	28.61	3821.70				
6-Feb-2008	27.53	3822.78				
14-Nov-2007	27.61	3822.70				
11-Sep-2007	28.19	3822.12				

**TABLE 1. SUMMARY OF MONITORING WELL FLUID GAUGING DATA
DONA ANA DAIRIES, DONA ANA COUNTY, NEW MEXICO**

Monitoring Well	Date Measured	Northing ^a	Easting ^a	Casing Elevation ^b	Depth to Water ^c	Ground Water Elevation ^b
126-05	20-Nov-2023	422293.26	1510649.84	3842.62	30.70	3811.92
	27-Aug-2023				30.80	3811.82
	24-May-2023				30.70	3811.92
	11-Jan-2023				29.70	3812.92
	8-Nov-2022				30.05	3812.57
	17-Aug-2022				30.05	3812.57
	5-May-2022				28.20	3814.42
	24-Feb-2022				28.27	3814.35
	9-Nov-2021				28.00	3814.62
	11-Aug-2021				28.10	3814.52
	4-May-2021				27.40	3815.22
	9-Feb-2021				28.60	3814.02
	10-Nov-2020				26.85	3815.77
	12-Aug-2020				27.45	3815.17
	11-May-2020				29.35	3813.27
	4-Feb-2020				28.48	3814.14
	8-Nov-2019				27.71	3814.91
	1-Aug-2019				28.31	3814.31
	8-May-2019				28.04	3814.58
	19-Feb-2019				27.25	3815.37
	12-Nov-2018				27.08	3815.54
	6-Aug-2018				27.53	3815.09
	17-May-2018				27.53	3815.09
	5-Feb-2018				26.59	3816.03
	6-Nov-2017				27.15	3815.47
	7-Aug-2017				28.39	3814.23
	15-May-2017				28.59	3814.03
	6-Feb-2017				27.91	3814.71
	7-Nov-2016				28.45	3814.17
	15-Aug-2016				29.25	3813.37
	16-May-2016				29.48	3813.14
	9-Feb-2016				28.32	3814.30
	5-Nov-2015				28.80	3813.82
	5-Aug-2015				29.38	3813.24
	6-May-2015				28.87	3813.75
	5-Feb-2015				27.65	3814.97
	5-Nov-2014				27.95	3814.67
	12-Aug-2014				27.85	3814.77
	12-May-2014				27.63	3814.99
	12-Feb-2014				26.34	3816.28
6-Nov-2013	26.67	3815.95				
6-Aug-2013	25.20	3817.42				
7-May-2013	24.65	3817.97				
7-Feb-2013	24.71	3817.91				
24-Oct-2012	24.96	3817.66				
30-Jul-2012	24.73	3817.89				
23-Apr-2012	24.21	3818.41				
26-Jan-2012	23.52	3819.10				
8-Dec-2011	23.50	3819.12				
19-Jul-2011	22.72	3819.90				
20-Apr-2011	21.74	3820.88				
21-Jan-2011	21.30	3821.32				
14-Sep-2010	20.91	3821.71				
24-Jun-2010	21.13	3821.49				
22-Mar-2010	21.06	3821.56				
8-Dec-2009	20.88	3821.74				
28-Aug-2009	20.83	3821.79				
26-May-2009	20.91	3821.71				
11-Dec-2008	20.29	3822.33				
27-Sep-2008	20.42	3822.20				
10-Jun-2008	21.26	3821.36				
6-Feb-2008	20.34	3822.28				
14-Nov-2007	20.32	3822.30				
11-Sep-2007	20.74	3821.88				

**TABLE 1. SUMMARY OF MONITORING WELL FLUID GAUGING DATA
DONA ANA DAIRIES, DONA ANA COUNTY, NEW MEXICO**

Monitoring Well	Date Measured	Northing ^a	Easting ^a	Casing Elevation ^b	Depth to Water ^c	Ground Water Elevation ^b
126-07	20-Nov-2023	423613.62	1509986.47	3850.94	Dry	
	27-Aug-2023				39.70	3811.24
	24-May-2023				39.63	3811.31
	11-Jan-2023				38.20	3812.74
	8-Nov-2022				38.80	3812.14
	17-Aug-2022				38.92	3812.02
	5-May-2022				37.84	3813.10
	24-Feb-2022				36.54	3814.40
	9-Nov-2021				37.00	3813.94
	11-Aug-2021				36.55	3814.39
	4-May-2021				35.90	3815.04
	9-Feb-2021				35.10	3815.84
	10-Nov-2020				35.70	3815.24
	12-Aug-2020				36.09	3814.85
	11-May-2020				36.16	3814.78
	4-Feb-2020				35.55	3815.39
	8-Nov-2019				35.66	3815.28
	1-Aug-2019				36.76	3814.18
	8-May-2019				36.40	3814.54
	19-Feb-2019				35.50	3815.44
	12-Nov-2018				35.67	3815.27
	6-Aug-2018				36.38	3814.56
	17-May-2018				35.74	3815.20
	5-Feb-2018				34.80	3816.14
	6-Nov-2017				35.45	3815.49
	7-Aug-2017				36.76	3814.18
	15-May-2017				36.85	3814.09
	6-Feb-2017				35.95	3814.99
	7-Nov-2016				36.79	3814.15
	15-Aug-2016				37.54	3813.40
	16-May-2016				37.36	3813.58
	9-Feb-2016				36.33	3814.61
	5-Nov-2015				36.94	3814.00
	5-Aug-2015				37.39	3813.55
	6-May-2015				36.68	3814.26
	5-Feb-2015				35.62	3815.32
	5-Nov-2014				36.34	3814.60
	12-Aug-2014				36.22	3814.72
	12-May-2014				35.52	3815.42
	12-Feb-2014				34.38	3816.56
6-Nov-2013	34.89	3816.05				
6-Aug-2013	32.46	3818.48				
7-May-2013	32.33	3818.61				
7-Feb-2013	32.58	3818.36				
24-Oct-2012	32.97	3817.97				
30-Jul-2012	32.60	3818.34				
23-Apr-2012	31.84	3819.10				
26-Jan-2012	31.23	3819.71				
8-Dec-2011	31.28	3819.66				
19-Jul-2011	30.30	3820.64				
20-Apr-2011	28.59	3822.35				
27-Jan-2011	28.43	3822.51				
14-Sep-2010	28.45	3822.49				
24-Jun-2010	28.74	3822.20				
22-Mar-2010	28.57	3822.37				
8-Dec-2009	28.37	3822.57				
28-Aug-2009	28.61	3822.33				
26-May-2009	28.47	3822.47				
11-Dec-2008	27.70	3823.24				
27-Sep-2008	27.97	3822.97				
10-Jun-2008	28.78	3822.16				
6-Feb-2008	27.71	3823.23				
14-Nov-2007	27.63	3823.31				
11-Sep-2007	28.06	3822.88				

**TABLE 1. SUMMARY OF MONITORING WELL FLUID GAUGING DATA
DONA ANA DAIRIES, DONA ANA COUNTY, NEW MEXICO**

Monitoring Well	Date Measured	Northing ^a	Easting ^a	Casing Elevation ^b	Depth to Water ^c	Ground Water Elevation ^b
126-09	20-Nov-2023	425154.15	1510994.31	3893.35	Dry	
	27-Aug-2023				82.40	3810.95
	24-May-2023				82.25	3811.10
	11-Jan-2023				80.70	3812.65
	8-Nov-2022				81.50	3811.85
	17-Aug-2022				82.20	3811.15
	5-May-2022				80.91	3812.44
	24-Feb-2022				79.55	3813.80
	9-Nov-2021				80.40	3812.95
	11-Aug-2021				80.60	3812.75
	4-May-2021				79.50	3813.85
	9-Feb-2021				78.50	3814.85
	10-Nov-2020				79.50	3813.85
	12-Aug-2020				80.00	3813.35
	11-May-2020				80.31	3813.04
	4-Feb-2020				79.67	3813.68
	8-Nov-2019				79.08	3814.27
	1-Aug-2019				80.45	3812.90
	8-May-2019				79.95	3813.40
	19-Feb-2019				78.70	3814.65
	12-Nov-2018				79.00	3814.35
	6-Aug-2018				80.10	3813.25
	17-May-2018				79.28	3814.07
	5-Feb-2018				77.87	3815.48
	6-Nov-2017				78.83	3814.52
	7-Aug-2017				79.61	3813.74
	15-May-2017				79.78	3813.57
	6-Feb-2017				77.00	3816.35
	7-Nov-2016				79.62	3813.73
	15-Aug-2016				80.33	3813.02
	16-May-2016				80.00	3813.35
	9-Feb-2016				78.58	3814.77
	5-Nov-2015				79.27	3814.08
	5-Aug-2015				79.72	3813.63
	6-May-2015				79.01	3814.34
	5-Feb-2015				77.53	3815.82
	5-Nov-2014				78.21	3815.14
	12-Aug-2014				78.15	3815.20
	12-May-2014				77.70	3815.65
	12-Feb-2014				76.14	3817.21
6-Nov-2013	76.91	3816.44				
6-Aug-2013	76.09	3817.26				
7-May-2013	75.40	3817.95				
7-Feb-2013	74.61	3818.74				
24-Oct-2012	75.29	3818.06				
30-Jul-2012	74.98	3818.37				
23-Apr-2012	73.98	3819.37				
26-Jan-2012	72.24	3821.11				
8-Dec-2011	73.34	3820.01				
19-Jul-2011	73.19	3820.16				
20-Apr-2011	72.11	3821.24				
21-Jan-2011	71.00	3822.35				
14-Sep-2010	71.52	3821.83				
29-Jun-2010	72.23	3821.12				
22-Mar-2010	71.03	3822.32				
8-Dec-2009	70.94	3822.41				
28-Aug-2009	71.73	3821.62				
26-May-2009	71.12	3822.23				
11-Dec-2008	70.27	3823.08				
27-Sep-2008	70.79	3822.56				
10-Jun-2008	71.47	3821.88				
6-Feb-2008	70.08	3823.27				
14-Nov-2007	70.46	3822.89				
11-Sep-2007	71.39	3821.96				

**TABLE 1. SUMMARY OF MONITORING WELL FLUID GAUGING DATA
DONA ANA DAIRIES, DONA ANA COUNTY, NEW MEXICO**

Monitoring Well	Date Measured	Northing ^a	Easting ^a	Casing Elevation ^b	Depth to Water ^c	Ground Water Elevation ^b		
126-12	20-Nov-2023	421492.11	1510198.45	3838.88	26.80	3812.08		
	27-Aug-2023				26.25	3812.63		
	24-May-2023				26.45	3812.43		
	11-Jan-2023				25.35	3813.53		
	8-Nov-2022				25.30	3813.58		
	17-Aug-2022				24.45	3814.43		
	5-May-2022				24.26	3814.62		
	24-Feb-2022				23.55	3815.33		
	9-Nov-2021				22.86	3816.02		
	11-Aug-2021				22.60	3816.28		
	4-May-2021				22.15	3816.73		
	9-Feb-2021				22.00	3816.88		
	10-Nov-2020				21.50	3817.38		
	12-Aug-2020				21.61	3817.27		
	11-May-2020				22.70	3816.18		
	4-Feb-2020				22.50	3816.38		
	8-Nov-2019				21.69	3817.19		
	1-Aug-2019				22.84	3816.04		
	8-May-2019				22.70	3816.18		
	19-Feb-2019				22.50	3816.38		
	12-Nov-2018				21.94	3816.94		
	6-Aug-2018				21.56	3817.32		
	17-May-2018				Covered in dirt			
	5-Feb-2018				21.85	3817.03		
	6-Nov-2017				21.90	3816.98		
	7-Aug-2017				23.26	3815.62		
	15-May-2017				23.65	3815.23		
	6-Feb-2017				23.62	3815.26		
	7-Nov-2016				23.59	3815.29		
	15-Aug-2016				24.52	3814.36		
	16-May-2016				24.84	3814.04		
	9-Feb-2016				24.41	3814.47		
	5-Nov-2015				24.05	3814.83		
	5-Aug-2015				25.02	3813.86		
	6-May-2015				24.78	3814.10		
	5-Feb-2015				23.86	3815.02		
	5-Nov-2014				23.65	3815.23		
	14-Aug-2014				23.37	3815.51		
	12-May-2014				23.60	3815.28		
	12-Feb-2014				22.46	3816.42		
	6-Nov-2013				22.39	3816.49		
	6-Aug-2013				21.44	3817.44		
	7-May-2013				21.05	3817.83		
	7-Feb-2013				20.92	3817.96		
	24-Oct-2012				20.53	3818.35		
	30-Jul-2012				20.48	3818.40		
	23-Apr-2012				20.22	3818.66		
	30-Jan-2012				19.79	3819.09		
	8-Dec-2011				19.55	3819.33		
	19-Jul-2011				18.27	3820.61		
20-Apr-2011	17.62	3821.26						
17-Jan-2011	17.00	3821.88						
16-Sep-2010	16.48	3822.40						
24-Jun-2010	17.30	3821.58						
24-Jun-2010	17.30	3821.58						
22-Mar-2010	17.19	3821.69						
8-Dec-2009	16.99	3821.89						
28-Aug-2009	16.49	3822.39						
26-May-2009	16.85	3822.03						
11-Dec-2008	16.37	3822.51						
27-Sep-2008	16.29	3822.59						
10-Jun-2008	17.19	3821.69						
6-Feb-2008	16.62	3822.26						
14-Nov-2007	16.33	3822.55						
11-Sep-2007	16.56	3822.32						

**TABLE 1. SUMMARY OF MONITORING WELL FLUID GAUGING DATA
DONA ANA DAIRIES, DONA ANA COUNTY, NEW MEXICO**

Monitoring Well	Date Measured	Northing ^a	Easting ^a	Casing Elevation ^b	Depth to Water ^c	Ground Water Elevation ^b
126-13	20-Nov-2023	423431.96	1510657.41	3857.37	46.05	3811.32
	27-Aug-2023				46.35	3811.02
	24-May-2023				46.50	3810.87
	11-Jan-2023				44.75	3812.62
	8-Nov-2022				45.40	3811.97
	17-Aug-2022				45.65	3811.72
	5-May-2022				44.54	3812.83
	24-Feb-2022				43.30	3814.07
	9-Nov-2021				43.90	3813.47
	11-Aug-2021				43.80	3813.57
	4-May-2021				43.05	3814.32
	9-Feb-2021				42.10	3815.27
	10-Nov-2020				42.80	3814.57
	12-Aug-2020				43.31	3814.06
	11-May-2020				43.03	3814.34
	4-Feb-2020				42.42	3814.95
	8-Nov-2019				42.75	3814.62
	1-Aug-2019				43.91	3813.46
	8-May-2019				43.48	3813.89
	19-Feb-2019				42.45	3814.92
	12-Nov-2018				42.70	3814.67
	6-Aug-2018				43.52	3813.85
	17-May-2018				42.90	3814.47
	5-Feb-2018				41.78	3815.59
	6-Nov-2017				42.61	3814.76
	7-Aug-2017				43.70	3813.67
	15-May-2017				43.74	3813.63
	6-Feb-2017				42.64	3814.73
	7-Nov-2016				43.60	3813.77
	15-Aug-2016				44.35	3813.02
	16-May-2016				44.13	3813.24
	9-Feb-2016				42.93	3814.44
	5-Nov-2015				43.55	3813.82
	5-Aug-2015				44.00	3813.37
	6-May-2015				43.34	3814.03
	5-Feb-2015				42.05	3815.32
	5-Nov-2014				42.63	3814.74
	12-Aug-2014				42.60	3814.77
	12-May-2014				42.04	3815.33
	12-Feb-2014				40.78	3816.59
6-Nov-2013	41.35	3816.02				
6-Aug-2013	39.96	3817.41				
7-May-2013	39.01	3818.36				
7-Feb-2013	39.07	3818.30				
24-Oct-2012	39.60	3817.77				
30-Jul-2012	39.30	3818.07				
23-Apr-2012	38.52	3818.85				
26-Jan-2012	37.80	3819.57				
8-Dec-2011	37.86	3819.51				
19-Jul-2011	37.29	3820.08				
20-Apr-2011	35.23	3822.14				
13-Jan-2011	35.23	3822.14				
14-Sep-2010	35.66	3821.71				
24-Jun-2010	36.01	3821.36				
22-Mar-2010	35.40	3821.97				
8-Dec-2009	35.24	3822.13				
28-Aug-2009	35.60	3821.77				
26-May-2009	35.37	3822.00				
11-Dec-2008	34.62	3822.75				
27-Sep-2008	34.99	3822.38				
10-Jun-2008	35.69	3821.68				
6-Feb-2008	NA	NA				
14-Nov-2007	16.33	3841.04				
11-Sep-2007	NA	NA				

**TABLE 1. SUMMARY OF MONITORING WELL FLUID GAUGING DATA
DONA ANA DAIRIES, DONA ANA COUNTY, NEW MEXICO**

Monitoring Well	Date Measured	Northing ^a	Easting ^a	Casing Elevation ^b	Depth to Water ^c	Ground Water Elevation ^b
Mountain View Dairy						
70-01	1-Nov-2023	423303.43	1510585.63	3851.84	41.06	3810.78
	2-Aug-2023				40.90	3810.94
	1-May-2023				40.06	3811.78
	2-Feb-2023				39.15	3812.69
	1-Nov-2022				39.80	3812.04
	1-Aug-2022				39.42	3812.42
	2-May-2022				38.55	3813.29
	7-Feb-2022				37.80	3814.04
	1-Nov-2021				38.21	3813.63
	4-Aug-2021				37.95	3813.89
	3-May-2021				37.50	3814.34
	10-Feb-2021				36.89	3814.95
	2-Nov-2020				37.35	3814.49
	10-Aug-2020				37.85	3813.99
	11-May-2020				37.29	3814.55
	4-Feb-2020				36.92	3814.92
	8-Nov-2019				37.41	3814.43
	1-Aug-2019				38.34	3813.50
	8-May-2019				37.90	3813.94
	19-Feb-2019				36.90	3814.94
	12-Nov-2018				37.15	3814.69
	6-Aug-2018				37.95	3813.89
	17-May-2018				37.34	3814.50
	5-Feb-2018				36.25	3815.59
	6-Nov-2017				37.05	3814.79
	8-Aug-2017				38.17	3813.67
	15-May-2017				38.22	3813.62
	6-Feb-2017				37.16	3814.68
	22-Nov-2016				37.93	3813.91
	15-Aug-2016				38.85	3812.99
	16-May-2016				38.62	3813.22
	9-Feb-2016				37.43	3814.41
	6-Nov-2015				38.07	3813.77
	5-Aug-2015				38.59	3813.25
	6-May-2015				37.85	3813.99
	5-Feb-2015				36.61	3815.23
	5-Nov-2014				37.17	3814.67
	12-Aug-2014				37.18	3814.66
	12-May-2014				36.56	3815.28
	12-Feb-2014				35.33	3816.51
	6-Nov-2013				35.67	3816.17
	6-Aug-2013				34.19	3817.65
	7-May-2013				34.06	3817.78
	7-Feb-2013				33.58	3818.26
	24-Oct-2012				34.08	3817.76
	30-Jul-2012				33.80	3818.04
	23-Apr-2012				33.09	3818.75
26-Jan-2012	32.29	3819.55				
8-Dec-2011	32.40	3819.44				
9-Jul-2011	31.77	3820.07				
20-Apr-2011	30.69	3821.15				
17-Jan-2011	29.72	3822.12				
14-Sep-2010	30.19	3821.65				
24-Jun-2010	29.30	3822.54				
22-Mar-2010	Unable to open well					
8-Dec-2009	29.75	3822.09				
28-Aug-2009	30.08	3821.76				
26-May-2009	29.88	3821.96				
11-Dec-2008	29.13	3822.71				
27-Sep-2008	29.79	3822.05				
10-Jun-2008	30.20	3821.64				
5-Feb-2008	29.10	3822.74				
13-Nov-2007	29.25	3822.59				
12-Sep-2007	29.77	3822.07				

**TABLE 1. SUMMARY OF MONITORING WELL FLUID GAUGING DATA
DONA ANA DAIRIES, DONA ANA COUNTY, NEW MEXICO**

Monitoring Well	Date Measured	Northing ^a	Easting ^a	Casing Elevation ^b	Depth to Water ^c	Ground Water Elevation ^b
70-02	1-Nov-2023	423412.73	1511192.51	3861.25	49.02	3812.23
	2-Aug-2023				48.51	3812.74
	1-May-2023				47.65	3813.60
	2-Feb-2023				48.62	3812.63
	1-Nov-2022				49.35	3811.90
	1-Aug-2022				49.11	3812.14
	2-May-2022				48.65	3812.60
	7-Feb-2022				47.83	3813.42
	1-Nov-2021				48.08	3813.17
	4-Aug-2021				47.76	3813.49
	3-May-2021				47.11	3814.14
	10-Feb-2021				46.79	3814.46
	2-Nov-2020				47.20	3814.05
	10-Aug-2020				47.67	3813.58
	11-May-2020				47.26	3813.99
	4-Feb-2020				46.60	3814.65
	8-Nov-2019				47.13	3814.12
	1-Aug-2019				48.17	3813.08
	8-May-2019				47.70	3813.55
	19-Feb-2019				46.64	3814.61
	12-Nov-2018				46.90	3814.35
	6-Aug-2018				47.78	3813.47
	17-May-2018				47.19	3814.06
	5-Feb-2018				45.97	3815.28
	6-Nov-2017				46.85	3814.40
	8-Aug-2017				47.85	3813.40
	15-May-2017				47.93	3813.32
	6-Feb-2017				46.70	3814.55
	7-Nov-2016				47.74	3813.51
	15-Aug-2016				48.46	3812.79
	16-May-2016				48.26	3812.99
	9-Feb-2016				46.96	3814.29
	6-Nov-2015				47.58	3813.67
	5-Aug-2015				48.06	3813.19
	6-May-2015				47.40	3813.85
	5-Feb-2015				46.00	3815.25
	5-Nov-2014				46.67	3814.58
	13-Aug-2014				46.73	3814.52
	12-May-2014				46.08	3815.17
	12-Feb-2014				44.75	3816.50
	6-Nov-2013				45.31	3815.94
	6-Aug-2013				43.87	3817.38
	7-May-2013				43.16	3818.09
	7-Feb-2013				43.13	3818.12
	24-Oct-2012				43.66	3817.59
	30-Jul-2012				43.33	3817.92
	23-Apr-2012				42.60	3818.65
	26-Jan-2012				41.81	3819.44
	8-Dec-2011				41.89	3819.36
	19-Jul-2011				41.52	3819.73
	20-Apr-2011				40.46	3820.79
	17-Jan-2011				38.90	3822.35
	14-Sep-2010				39.96	3821.29
	24-Jun-2010				39.01	3822.24
	22-Mar-2010				39.54	3821.71
	8-Dec-2009				39.42	3821.83
	28-Aug-2009				39.81	3821.44
	26-May-2009				39.56	3821.69
	11-Dec-2008				38.84	3822.41
	27-Sep-2008				39.20	3822.05
	10-Jun-2008				39.90	3821.35
	6-Feb-2008				39.77	3821.48
	14-Nov-2007				39.01	3822.24
	11-Sep-2007				39.60	3821.65

**TABLE 1. SUMMARY OF MONITORING WELL FLUID GAUGING DATA
DONA ANA DAIRIES, DONA ANA COUNTY, NEW MEXICO**

Monitoring Well	Date Measured	Northing ^a	Easting ^a	Casing Elevation ^b	Depth to Water ^c	Ground Water Elevation ^b
70-04	1-Nov-2023	422798.94	1510922.20	3849.81	38.81	3811.00
	2-Aug-2023				38.74	3811.07
	1-May-2023				38.02	3811.79
	2-Feb-2023				37.10	3812.71
	1-Nov-2022				37.50	3812.31
	1-Aug-2022				37.61	3812.20
	2-May-2022				36.78	3813.03
	7-Feb-2022				35.90	3813.91
	1-Nov-2021				36.11	3813.70
	4-Aug-2021				35.89	3813.92
	3-May-2021				35.41	3814.40
	10-Feb-2021				34.66	3815.15
	2-Nov-2020				35.15	3814.66
	10-Aug-2020				35.75	3814.06
	11-May-2020				35.71	3814.10
	4-Feb-2020				34.95	3814.86
	8-Nov-2019				35.03	3814.78
	1-Aug-2019				36.35	3813.46
	8-May-2019				35.47	3814.34
	19-Feb-2019				35.00	3814.81
	12-Nov-2018				35.09	3814.72
	6-Aug-2018				35.90	3813.91
	17-May-2018				35.55	3814.26
	5-Feb-2018				34.36	3815.45
	6-Nov-2017				35.11	3814.70
	8-Aug-2017				36.22	3813.59
	15-May-2017				36.36	3813.45
	6-Feb-2017				35.31	3814.50
	7-Nov-2016				36.15	3813.66
	15-Aug-2016				36.92	3812.89
	16-May-2016				36.90	3812.91
	9-Feb-2016				35.63	3814.18
	6-Nov-2015				36.17	3813.64
5-Aug-2015	36.74	3813.07				
6-May-2015	36.13	3813.68				
5-Feb-2015	34.78	3815.03				
5-Nov-2014	35.20	3814.61				
13-Aug-2014	35.31	3814.50				
12-May-2014	34.81	3815.00				
12-Feb-2014	33.52	3816.29				
7-Nov-2013	34.05	3815.76				
6-Aug-2013	32.03	3817.78				
7-May-2013	31.80	3818.01				
7-Feb-2013	31.85	3817.96				

**TABLE 1. SUMMARY OF MONITORING WELL FLUID GAUGING DATA
DONA ANA DAIRIES, DONA ANA COUNTY, NEW MEXICO**

Monitoring Well	Date Measured	Northing ^a	Easting ^a	Casing Elevation ^b	Depth to Water ^c	Ground Water Elevation ^b
Buena Vista Dairy I						
86-01	1-Nov-2023	421534.62	1511667.76	3864.96	53.38	3811.58
	2-Aug-2023				53.31	3811.65
	1-May-2023				52.55	3812.41
	2-Feb-2023				52.22	3812.74
	1-Nov-2022				52.40	3812.56
	1-Aug-2022				52.30	3812.66
	2-May-2022				51.78	3813.18
	7-Feb-2022				50.92	3814.04
	1-Nov-2021				50.89	3814.07
	4-Aug-2021				50.66	3814.30
	3-May-2021				50.40	3814.56
	10-Feb-2021				50.02	3814.94
	2-Nov-2020				50.29	3814.67
	10-Aug-2020				51.10	3813.86
	11-May-2020				51.43	3813.53
	4-Feb-2020				50.07	3814.89
	8-Nov-2019				50.00	3814.96
	1-Aug-2019				51.19	3813.77
	8-May-2019				50.91	3814.05
	19-Feb-2019				50.15	3814.81
	12-Nov-2018				50.04	3814.92
	6-Aug-2018				50.62	3814.34
	17-May-2018				50.71	3814.25
	5-Feb-2018				49.60	3815.36
	6-Nov-2017				50.25	3814.71
	7-Aug-2017				51.12	3813.84
	15-May-2017				51.43	3813.53
	6-Feb-2017				50.60	3814.36
	7-Nov-2016				51.26	3813.70
	15-Aug-2016				51.89	3813.07
	16-May-2016				52.08	3812.88
	9-Feb-2016				51.00	3813.96
	5-Nov-2015				51.43	3813.53
	5-Aug-2015				51.83	3813.13
	6-May-2015				51.44	3813.52
	5-Feb-2015				50.13	3814.83
	5-Nov-2014				50.40	3814.56
	13-Aug-2014				50.29	3814.67
	12-May-2014				50.20	3814.76
	17-Feb-2014				48.87	3816.09
6-Nov-2013	42.33	3822.63				
6-Aug-2013	47.43	3817.53				
7-May-2013	47.21	3817.75				
7-Feb-2013	47.35	3817.61				
24-Oct-2012	47.61	3817.35				
30-Jul-2012	47.26	3817.70				
23-Apr-2012	46.86	3818.10				
30-Jan-2012	46.34	3818.62				
8-Dec-2011	46.22	3818.74				
19-Jul-2011	45.66	3819.30				
20-Apr-2011	44.28	3820.68				
17-Jan-2011	44.30	3820.66				
16-Sep-2010	44.09	3820.87				
24-Jun-2010	44.39	3820.57				
22-Mar-2010	44.19	3820.77				
8-Dec-2009	43.89	3821.07				
28-Aug-2009	43.96	3821.00				
26-May-2009	44.03	3820.93				
11-Dec-2008	43.53	3821.43				
28-Sep-2008	43.60	3821.36				
10-Jun-2008	44.44	3820.52				
5-Feb-2008	43.69	3821.27				
13-Nov-2007	43.78	3821.18				
12-Sep-2007	44.21	3820.75				

**TABLE 1. SUMMARY OF MONITORING WELL FLUID GAUGING DATA
DONA ANA DAIRIES, DONA ANA COUNTY, NEW MEXICO**

Monitoring Well	Date Measured	Northing ^a	Easting ^a	Casing Elevation ^b	Depth to Water ^c	Ground Water Elevation ^b
86-02	1-Nov-2023	421792.08	1510881.53	3848.08	36.00	3812.08
	2-Aug-2023				35.15	3812.93
	1-May-2023				34.63	3813.45
	2-Feb-2023				34.80	3813.28
	1-Nov-2022				34.45	3813.63
	1-Aug-2022				34.38	3813.70
	2-May-2022				34.00	3814.08
	7-Feb-2022				33.08	3815.00
	1-Nov-2021				32.84	3815.24
	4-Aug-2021				32.59	3815.49
	3-May-2021				32.31	3815.77
	10-Feb-2021				32.09	3815.99
	2-Nov-2020				32.11	3815.97
	10-Aug-2020				32.21	3815.87
	11-May-2020				32.90	3815.18
	4-Feb-2020				32.20	3815.88
	8-Nov-2019				32.89	3815.19
	1-Aug-2019				33.00	3815.08
	8-May-2019				32.81	3815.27
	19-Feb-2019				32.27	3815.81
	12-Nov-2018				31.95	3816.13
	6-Aug-2018				32.15	3815.93
	17-May-2018				32.49	3815.59
	5-Feb-2018				31.66	3816.42
	6-Nov-2017				32.05	3816.03
	7-Aug-2017				33.08	3815.00
	15-May-2017				33.50	3814.58
	6-Feb-2017				33.09	3814.99
	7-Nov-2016				33.40	3814.68
	15-Aug-2016				34.15	3813.93
	16-May-2016				34.45	3813.63
	9-Feb-2016				33.64	3814.44
	5-Nov-2015				33.87	3814.21
	5-Aug-2015				34.35	3813.73
	6-May-2015				33.97	3814.11
	5-Feb-2015				32.88	3815.20
	5-Nov-2014				33.01	3815.07
	12-Aug-2014				32.62	3815.46
	12-May-2014				32.70	3815.38
	12-Feb-2014				31.62	3816.46
	6-Nov-2013				31.68	3816.40
	6-Aug-2013				30.37	3817.71
	7-May-2013				30.13	3817.95
	7-Feb-2013				30.07	3818.01
	24-Oct-2012				29.71	3818.37
	30-Jul-2012				29.71	3818.37
	23-Apr-2012				29.43	3818.65
	30-Jan-2012				28.94	3819.14
	8-Dec-2011				28.77	3819.31
	19-Jul-2011				27.74	3820.34
	20-Apr-2011				27.18	3820.90
	17-Jan-2011				26.34	3821.74
	16-Sep-2010				26.18	3821.90
	24-Jun-2010				26.79	3821.29
	22-Mar-2010				26.54	3821.54
	8-Dec-2009				26.33	3821.75
	28-Aug-2009				26.11	3821.97
	26-May-2009				26.29	3821.79
	11-Dec-2008				25.77	3822.31
	28-Sep-2008				25.78	3822.3
	10-Jun-2008				26.65	3821.43
	5-Feb-2008				26.95	3821.13
	13-Nov-2007				25.88	3822.2
	12-Sep-2007				26.19	3821.89

**TABLE 1. SUMMARY OF MONITORING WELL FLUID GAUGING DATA
DONA ANA DAIRIES, DONA ANA COUNTY, NEW MEXICO**

Monitoring Well	Date Measured	Northing ^a	Easting ^a	Casing Elevation ^b	Depth to Water ^c	Ground Water Elevation ^b
Bright Star Dairy						
340-01	1-Nov-2023	421410.13	1511423.42	3858.48	46.70	3811.78
	2-Aug-2023				46.68	3811.80
	1-May-2023				46.30	3812.18
	2-Feb-2023				45.50	3812.98
	1-Nov-2022				45.46	3813.02
	1-Aug-2022				45.16	3813.32
	2-May-2022				44.84	3813.64
	7-Feb-2022				44.02	3814.46
	1-Nov-2021				43.80	3814.68
	4-Aug-2021				43.56	3814.92
	3-May-2021				43.26	3815.22
	10-Feb-2021				42.78	3815.70
	2-Nov-2020				43.01	3815.47
	10-Aug-2020				43.31	3815.17
	11-May-2020				43.89	3814.59
	4-Feb-2020				43.12	3815.36
	8-Nov-2019				43.03	3815.45
	1-Aug-2019				44.00	3814.48
	8-May-2019				43.77	3814.71
	19-Feb-2019				43.18	3815.30
	12-Nov-2018				42.93	3815.55
	6-Aug-2018				43.18	3815.30
	17-May-2018				43.66	3814.82
	5-Feb-2018				42.66	3815.82
	6-Nov-2017				43.15	3815.33
	8-Aug-2017				44.00	3814.48
	15-May-2017				44.49	3813.99
	6-Feb-2017				43.92	3814.56
	7-Nov-2016				44.31	3814.17
	15-Aug-2016				44.97	3813.51
	16-May-2016				45.23	3813.25
	9-Feb-2016				44.37	3814.11
	6-Nov-2015				44.60	3813.88
	5-Aug-2015				45.01	3813.47
	6-May-2015				44.62	3813.86
	5-Feb-2015				43.56	3814.92
	5-Nov-2014				43.66	3814.82
	12-Aug-2014				43.32	3815.16
	12-May-2014				43.49	3814.99
	12-Feb-2014				42.30	3816.18
6-Nov-2013	42.33	3816.15				
6-Aug-2013	41.21	3817.27				
7-May-2013	40.80	3817.68				
7-Feb-2013	40.75	3817.73				
24-Oct-2012	40.82	3817.66				
30-Jul-2012	40.44	3818.04				
23-Apr-2012	40.16	3818.32				
25-Jan-2012	39.70	3818.78				
8-Dec-2011	39.54	3818.94				
19-Jul-2011	38.74	3819.74				
20-Apr-2011	38.14	3820.34				
17-Jan-2011	37.33	3821.15				
14-Sep-2010	37.20	3821.28				
24-Jun-2010	38.05	3820.43				
22-Mar-2010	37.48	3821.00				
8-Dec-2009	37.26	3821.22				
28-Aug-2009	37.10	3821.38				
26-May-2009	37.26	3821.22				
11-Dec-2008	36.79	3821.69				
27-Sep-2008	36.77	3821.71				
10-Jun-2008	37.63	3820.85				
6-Feb-2008	37.03	3821.45				
14-Nov-2007	37.00	3821.48				
11-Sep-2007	37.36	3821.12				

**TABLE 1. SUMMARY OF MONITORING WELL FLUID GAUGING DATA
DONA ANA DAIRIES, DONA ANA COUNTY, NEW MEXICO**

Monitoring Well	Date Measured	Northing ^a	Easting ^a	Casing Elevation ^b	Depth to Water ^c	Ground Water Elevation ^b
340-02	1-Nov-2023	420641.08	1512051.57	3869.76	Dry	
	2-Aug-2023				Dry	
	1-May-2023				Dry	
	2-Feb-2023				56.71	3813.05
	1-Nov-2022				56.69	3813.07
	1-Aug-2022				56.19	3813.57
	2-May-2022				56.11	3813.65
	7-Feb-2022				55.56	3814.20
	1-Nov-2021				55.08	3814.68
	4-Aug-2021				54.85	3814.91
	3-May-2021				54.77	3814.99
	10-Feb-2021				54.21	3815.55
	2-Nov-2020				54.36	3815.40
	10-Aug-2020				54.75	3815.01
	11-May-2020				55.31	3814.45
	4-Feb-2020				54.70	3815.06
	8-Nov-2019				54.40	3815.36
	1-Aug-2019				55.39	3814.37
	8-May-2019				55.20	3814.56
	19-Feb-2019				54.67	3815.09
	12-Nov-2018				54.45	3815.31
	6-Aug-2018				54.46	3815.30
	17-May-2018				55.35	3814.41
	5-Feb-2018				54.27	3815.49
	6-Nov-2017				54.74	3815.02
	8-Aug-2017				55.60	3814.16
	15-May-2017				56.00	3813.76
	6-Feb-2017				55.43	3814.33
	7-Nov-2016				55.78	3813.98
	15-Aug-2016				56.52	3813.24
	16-May-2016				56.40	3813.36
	9-Feb-2016				55.84	3813.92
	6-Nov-2015				56.01	3813.75
	5-Aug-2015				56.46	3813.30
	6-May-2015				56.10	3813.66
	5-Feb-2015				55.00	3814.76
	5-Nov-2014				55.05	3814.71
	12-Aug-2014				54.65	3815.11
	12-May-2014				54.80	3814.96
	12-Feb-2014				53.80	3815.96
	6-Nov-2013				53.59	3816.17
	6-Aug-2013				52.92	3816.84
	7-May-2013				52.34	3817.42
	7-Feb-2013				52.29	3817.47
	24-Oct-2012				52.26	3817.50
	30-Jul-2012				51.67	3818.09
	23-Apr-2012				51.61	3818.15
25-Jan-2012	51.31	3818.45				
8-Dec-2011	51.07	3818.69				
19-Jul-2011	50.24	3819.52				
20-Apr-2011	48.86	3820.90				
17-Jan-2011	49.00	3820.76				
14-Sep-2010	48.80	3820.96				
24-Jun-2010	49.67	3820.09				
22-Mar-2010	49.17	3820.59				
8-Dec-2009	49.03	3820.73				
28-Aug-2009	48.79	3820.97				
26-May-2009	48.94	3820.82				
11-Dec-2008	48.62	3821.14				
28-Sep-2008	48.48	3821.28				
10-Jun-2008	49.30	3820.46				
5-Feb-2008	48.90	3820.86				
14-Nov-2007	48.84	3820.92				
12-Sep-2007	49.28	3820.48				

**TABLE 1. SUMMARY OF MONITORING WELL FLUID GAUGING DATA
DONA ANA DAIRIES, DONA ANA COUNTY, NEW MEXICO**

Monitoring Well	Date Measured	Northing ^a	Easting ^a	Casing Elevation ^b	Depth to Water ^c	Ground Water Elevation ^b
Former D&J Dairy (Dominguez 2)						
42-02	2-Nov-2023	419982.45	1511126.19	3844.69	31.15	3813.54
	3-Aug-2023				30.76	3813.93
	2-May-2023				31.00	3813.69
	3-Feb-2023				30.01	3814.68
	2-Nov-2022				29.10	3815.59
	2-Aug-2022				28.18	3816.51
	2-May-2022				28.99	3815.70
	7-Feb-2022				28.09	3816.60
	1-Nov-2021				27.15	3817.54
	4-Aug-2021				26.90	3817.79
	3-May-2021				27.09	3817.60
	10-Feb-2021				26.82	3817.87
	2-Nov-2020				26.03	3818.66
	10-Aug-2020				27.90	3816.79
	11-May-2020				28.29	3816.40
	4-Feb-2020				27.68	3817.01
	8-Nov-2019				24.83	3819.86
	5-Aug-2019				26.81	3817.88
	8-May-2019				27.50	3817.19
	19-Feb-2019				27.30	3817.39
	13-Nov-2018				27.08	3817.61
	6-Aug-2018				25.50	3819.19
	17-May-2018				27.76	3816.93
	6-Feb-2018				27.10	3817.59
	7-Nov-2017				27.20	3817.49
	8-Aug-2017				27.34	3817.35
	15-May-2017				28.75	3815.94
	6-Feb-2017				29.21	3815.48
	7-Nov-2016				28.80	3815.89
	15-Aug-2016				28.80	3815.89
	17-May-2016				29.82	3814.87
	9-Feb-2016				29.95	3814.74
	5-Nov-2015				29.75	3814.94
	5-Aug-2015				29.41	3815.28
	7-May-2015				29.77	3814.92
	5-Feb-2015				29.23	3815.46
	10-Nov-2014				28.96	3815.73
	13-Aug-2014				27.44	3817.25
	13-May-2014				28.53	3816.16
	12-Feb-2014				27.97	3816.72
	6-Nov-2013				26.34	3818.35
	14-Aug-2013				26.66	3818.03
	7-May-2013				26.53	3818.16
	7-Feb-2013				26.48	3818.21
	24-Oct-2012				25.91	3818.78
	31-Jul-2012				25.05	3819.64
	23-Apr-2012				25.46	3819.23
	26-Jan-2012				25.71	3818.98
	8-Dec-2011				25.35	3819.34
	19-Jul-2011				23.15	3821.54
	19-Apr-2011				22.80	3821.89
	18-Jan-2011				23.30	3821.39
	15-Sep-2010				22.34	3822.35
	24-Jun-2010				22.84	3821.85
	22-Mar-2010				23.16	3821.53
	8-Dec-2009				22.87	3821.82
	28-Aug-2009				22.43	3822.26
	26-May-2009				22.73	3821.96
	11-Dec-2008				22.91	3821.78
	27-Sep-2008				22.28	3822.41
	10-Jun-2008				23.12	3821.57
	6-Feb-2008				23.43	3821.26
	13-Nov-2007				23.00	3821.69
	12-Sep-2007				23.15	3821.54

**TABLE 1. SUMMARY OF MONITORING WELL FLUID GAUGING DATA
DONA ANA DAIRIES, DONA ANA COUNTY, NEW MEXICO**

Monitoring Well	Date Measured	Northing ^a	Easting ^a	Casing Elevation ^b	Depth to Water ^c	Ground Water Elevation ^b
42-03	2-Nov-2023	419710.55	1514064.35	3898.46	88.06	3810.40
	3-Aug-2023				88.10	3810.36
	2-May-2023				87.33	3811.13
	2-Feb-2023				86.55	3811.91
	1-Nov-2022				86.76	3811.70
	1-Aug-2022				87.08	3811.38
	2-May-2022				86.28	3812.18
	7-Feb-2022				85.42	3813.04
	1-Nov-2021				85.70	3812.76
	4-Aug-2021				85.65	3812.81
	3-May-2021				85.15	3813.31
	10-Feb-2021				84.76	3813.70
	2-Nov-2020				85.01	3813.45
	10-Aug-2020				85.60	3812.86
	11-May-2020				85.01	3813.45
	4-Feb-2020				84.90	3813.56
	8-Nov-2019				84.22	3814.24
	5-Aug-2019				84.22	3814.24
	24-Jan-1900				86.35	3812.11
	8-May-2019				85.82	3812.64
	19-Feb-2019				85.05	3813.41
	13-Nov-2018				85.10	3813.36
	6-Aug-2018				85.91	3812.55
	17-May-2018				87.46	3811.00
	6-Feb-2018				84.66	3813.80
	7-Nov-2017				85.30	3813.16
	8-Aug-2017				86.20	3812.26
	15-May-2017				86.58	3811.88
	6-Feb-2017				85.27	3813.19
	7-Nov-2016				85.99	3812.47
	15-Aug-2016				86.55	3811.91
	17-May-2016				86.96	3811.50
	9-Feb-2016				85.37	3813.09
	5-Nov-2015				85.63	3812.83
	5-Aug-2015				87.05	3811.41
	7-May-2015				86.30	3812.16
	5-Feb-2015				84.36	3814.10
	10-Nov-2014				84.63	3813.83
	12-Aug-2014				84.73	3813.73
	13-May-2014				85.05	3813.41
12-Feb-2014	83.40	3815.06				
6-Nov-2013	83.89	3814.57				
6-Aug-2013	82.46	3816.00				
7-May-2013	81.97	3816.49				
7-Feb-2013	82.01	3816.45				
24-Oct-2012	82.70	3815.76				
31-Jul-2012	82.49	3815.97				
23-Apr-2012	81.57	3816.89				
25-Jan-2012	81.18	3817.28				
8-Dec-2011	81.26	3817.20				
19-Jul-2011	81.33	3817.13				
19-Apr-2011	80.21	3818.25				
18-Jan-2011	79.33	3819.13				
15-Sep-2010	79.91	3818.55				
24-Jun-2010	81.12	3817.34				
22-Mar-2010	79.57	3818.89				
8-Dec-2009	79.12	3819.34				
28-Aug-2009	79.26	3819.20				
26-May-2009	79.42	3819.04				
11-Dec-2008	78.89	3819.57				
27-Sep-2008	78.91	3819.55				
10-Jun-2008	79.91	3818.55				
6-Feb-2008	79.76	3818.70				
13-Nov-2007	79.15	3819.31				
12-Sep-2007	79.71	3818.75				

**TABLE 1. SUMMARY OF MONITORING WELL FLUID GAUGING DATA
DONA ANA DAIRIES, DONA ANA COUNTY, NEW MEXICO**

Monitoring Well	Date Measured	Northing ^a	Easting ^a	Casing Elevation ^b	Depth to Water ^c	Ground Water Elevation ^b
42-06	2-Nov-2023	420021.61	1511465.15	3850.15	37.54	3812.61
	3-Aug-2023				36.70	3813.45
	2-May-2023				37.20	3812.95
	3-Feb-2023				36.70	3813.45
	2-Nov-2022				35.12	3815.03
	2-Aug-2022				34.50	3815.65
	2-May-2022				35.31	3814.84
	7-Feb-2022				34.99	3815.16
	1-Nov-2021				34.02	3816.13
	4-Aug-2021				33.34	3816.81
	3-May-2021				33.76	3816.39
	10-Feb-2021				33.36	3816.79
	2-Nov-2020				32.96	3817.19
	10-Aug-2020				33.85	3816.30
	11-May-2020				34.55	3815.60
	4-Feb-2020				33.84	3816.31
	8-Nov-2019				31.38	3818.77
	5-Aug-2019				33.42	3816.73
	8-May-2019				33.80	3816.35
	19-Feb-2019				33.60	3816.55
	13-Nov-2018				33.29	3816.86
	6-Aug-2018				32.20	3817.95
	17-May-2018				34.08	3816.07
	6-Feb-2018				33.35	3816.80
	7-Nov-2017				33.54	3816.61
	8-Aug-2017				33.90	3816.25
	15-May-2017				34.92	3815.23
	6-Feb-2017				35.16	3814.99
	7-Nov-2016				34.93	3815.22
	15-Aug-2016				35.07	3815.08
	17-May-2016				35.91	3814.24
	9-Feb-2016				35.80	3814.35
	5-Nov-2015				35.37	3814.78
	5-Aug-2015				35.52	3814.63
	7-May-2015				35.70	3814.45
	5-Feb-2015				35.08	3815.07
	10-Nov-2014				34.83	3815.32
	13-Aug-2014				33.65	3816.50
	13-May-2014				34.50	3815.65
	12-Feb-2014				33.85	3816.30
	6-Nov-2013				31.68	3818.47
	6-Aug-2013				31.24	3818.91
	7-May-2013				32.71	3817.44
	7-Feb-2013				32.30	3817.85
	24-Oct-2012				31.80	3818.35
	31-Jul-2012				31.15	3819.00
	23-Apr-2012				31.37	3818.78
	25-Jan-2012				31.51	3818.64
	8-Dec-2011				31.19	3818.96
	19-Jul-2011				29.37	3820.78
	19-Apr-2011				29.66	3820.49
	18-Jan-2011				29.18	3820.97
	15-Sep-2010				28.36	3821.79
	24-Jun-2010				28.96	3821.19
	22-Mar-2010				29.04	3821.11
	8-Dec-2009				28.90	3821.25
	28-Aug-2009				28.44	3821.71
	26-May-2009				28.70	3821.45
	11-Dec-2008				28.75	3821.40
	27-Sep-2008				28.27	3821.88
	10-Jun-2008				29.03	3821.12
	6-Feb-2008				29.24	3820.91
	13-Nov-2007				28.87	3821.28
	12-Sep-2007				29.03	3821.12

**TABLE 1. SUMMARY OF MONITORING WELL FLUID GAUGING DATA
DONA ANA DAIRIES, DONA ANA COUNTY, NEW MEXICO**

Monitoring Well	Date Measured	Northing ^a	Easting ^a	Casing Elevation ^b	Depth to Water ^c	Ground Water Elevation ^b
42-07	10-Nov-2020	420584.8	1513076.66	3891.52	Plugged and Abandoned	
	2-Nov-2020				Dry	
	10-Aug-2020				Dry	
	11-May-2020				Dry	
	4-Feb-2020				Dry	
	8-Nov-2019				Dry	
	5-Aug-2019				Dry	
	8-May-2019				Dry	
	19-Feb-2019				Dry	
	13-Nov-2018				Dry	
	6-Aug-2018				Dry	
	17-May-2018				Dry	
	6-Feb-2018				Dry	
	7-Nov-2017				Dry	
	8-Aug-2017				Dry	
	15-May-2017				Dry	
	6-Feb-2017				Dry	
	7-Nov-2016				Dry	
	15-Aug-2016				Dry	
	17-May-2016				Dry	
	9-Feb-2016				Dry	
	5-Nov-2015				Dry	
	5-Aug-2015				Dry	
	7-May-2015				Dry	
	5-Feb-2015				Dry	
	10-Nov-2014				Dry	
	13-Aug-2014				Dry	
	13-May-2014				Dry	
	12-Feb-2014				Dry	
	6-Nov-2013				Dry	
	6-Aug-2013				Dry	
	7-May-2013				Dry	
	7-Feb-2013				Dry	
	24-Oct-2012				Dry	
	31-Jul-2012				Dry	
	23-Apr-2012				Dry	
	25-Jan-2012				Dry	
	8-Dec-2011				Dry	
	19-Jul-2011				Dry	
	19-Apr-2011				72.19	3819.33
18-Jan-2011	71.37	3820.15				
15-Sep-2010	71.64	3819.88				
24-Jun-2010	72.24	3819.28				
22-Mar-2010	71.43	3820.09				
8-Dec-2009	71.26	3820.26				
28-Aug-2009	71.26	3820.26				
26-May-2009	71.31	3820.21				
11-Dec-2008	70.87	3820.65				
27-Sep-2008	70.95	3820.57				
10-Jun-2008	71.71	3819.81				
6-Feb-2008	71.00	3820.52				
13-Nov-2007	71.12	3820.40				
12-Sep-2007	71.61	3819.91				

**TABLE 1. SUMMARY OF MONITORING WELL FLUID GAUGING DATA
DONA ANA DAIRIES, DONA ANA COUNTY, NEW MEXICO**

Monitoring Well	Date Measured	Northing ^a	Easting ^a	Casing Elevation ^b	Depth to Water ^c	Ground Water Elevation ^b
42-08	2-Nov-2023	419994.93	1511197.91	3846.53	33.63	3812.90
	3-Aug-2023				32.81	3813.72
	2-May-2023				31.91	3814.62
	3-Feb-2023				31.68	3814.85
	2-Nov-2022				31.00	3815.53
	2-Aug-2022				30.10	3816.43
	2-May-2022				31.00	3815.53
	7-Feb-2022				30.20	3816.33
	1-Nov-2021				29.71	3816.82
	4-Aug-2021				29.05	3817.48
	3-May-2021				29.60	3816.93
	10-Feb-2021				29.08	3817.45
	2-Nov-2020				28.44	3818.09
	10-Aug-2020				29.93	3816.60
	11-May-2020				30.63	3815.90
	4-Feb-2020				29.72	3816.81
	8-Nov-2019				28.12	3818.41
	5-Aug-2019				29.08	3817.45
	8-May-2019				29.61	3816.92
	19-Feb-2019				29.42	3817.11
	13-Nov-2018				29.14	3817.39
	6-Aug-2018				27.74	3818.79
	17-May-2018				29.88	3816.65
	6-Feb-2018				29.20	3817.33
	7-Nov-2017				29.37	3817.16
	8-Aug-2017				29.53	3817.00
	15-May-2017				30.80	3815.73
	6-Feb-2017				31.22	3815.31
	7-Nov-2016				30.87	3815.66
	15-Aug-2016				30.90	3815.63
	17-May-2016				Dry	
	9-Feb-2016				Dry	
	5-Nov-2015				Dry	
	5-Aug-2015				31.45	3815.08
	7-May-2015				31.77	3814.76
	5-Feb-2015				31.23	3815.30
	10-Nov-2014				30.97	3815.56
	13-Aug-2014				29.54	3816.99
	13-May-2014				30.68	3815.85
	12-Feb-2014				29.98	3816.55
	6-Nov-2013				28.26	3818.27
	6-Aug-2013				27.97	3818.56
	7-May-2013				28.69	3817.84
	7-Feb-2013				28.43	3818.10
	24-Oct-2012				27.92	3818.61
	31-Jul-2012				27.11	3819.42
	23-Apr-2012				27.51	3819.02
26-Jan-2012	27.68	3818.85				
8-Dec-2011	27.33	3819.20				
19-Jul-2011	25.24	3821.29				
19-Apr-2011	25.72	3820.81				
18-Jan-2011	25.28	3821.25				
15-Sep-2010	24.37	3822.16				
24-Jun-2010	24.91	3821.62				
22-Mar-2010	25.15	3821.38				
8-Dec-2009	24.91	3821.62				
28-Aug-2009	24.46	3822.07				
26-May-2009	24.75	3821.78				
11-Dec-2008	24.88	3821.65				
27-Sep-2008	24.30	3822.23				
10-Jun-2008	25.13	3821.40				
6-Feb-2008	25.41	3821.12				
13-Nov-2007	25.00	3821.53				
12-Sep-2007	25.13	3821.40				

**TABLE 1. SUMMARY OF MONITORING WELL FLUID GAUGING DATA
DONA ANA DAIRIES, DONA ANA COUNTY, NEW MEXICO**

Monitoring Well	Date Measured	Northing ^a	Easting ^a	Casing Elevation ^b	Depth to Water ^c	Ground Water Elevation ^b
42-09	4-Feb-2020	419729.17	1512255.76	3865.25	Damaged	
	8-Nov-2019				47.03	-47.03
	5-Aug-2019				49.72	3815.53
	8-May-2019				49.76	-49.76
	19-Feb-2019				49.69	-49.69
	13-Nov-2018				49.30	3815.95
	6-Aug-2018				48.59	3816.66
	17-May-2018				50.22	-50.22
	6-Feb-2018				49.37	-49.37
	7-Nov-2017				49.53	-49.53
	8-Aug-2017				50.35	-50.35
	15-May-2017				50.78	-50.78
	6-Feb-2017				50.95	-50.95
	7-Nov-2016				50.98	-50.98
	15-Aug-2016				51.29	-51.29
	17-May-2016				51.73	-51.73
	9-Feb-2016				51.39	-51.39
	5-Nov-2015				Damaged	
	5-Aug-2015				51.34	-51.34
	7-May-2015				51.23	-51.23
	5-Feb-2015				50.51	-50.51
	10-Nov-2014				50.21	-50.21
	12-Aug-2014				49.45	-49.45
	13-May-2014				49.85	-49.85
	12-Feb-2014				49.36	-49.36
	6-Nov-2013				48.23	-48.23
	6-Aug-2013				47.88	-47.88
	7-May-2013				48.04	-48.04
	7-Feb-2013				47.79	-47.79
	24-Oct-2012				47.29	-47.29
	31-Jul-2012				46.98	-46.98
	23-Apr-2012				46.93	-46.93
	25-Jan-2012				46.95	3818.30
	8-Dec-2011				46.76	-46.76
	19-Jul-2011				45.54	3819.71
	19-Apr-2011				45.38	3819.87
	18-Jan-2011				44.87	3820.38
	15-Sep-2010				44.21	-44.21
	24-Jun-2010				44.99	-44.99
	22-Mar-2010				44.72	-44.72
	8-Dec-2009				44.70	-44.70
	28-Aug-2009				44.32	-44.32
26-May-2009	44.50	-44.50				
11-Dec-2008	44.39	-44.39				
27-Sep-2008	44.12	-44.12				
10-Jun-2008	44.77	-44.77				
6-Feb-2008	44.80	-44.80				
13-Nov-2007	44.47	-44.47				
12-Sep-2007	44.73	-44.73				

**TABLE 1. SUMMARY OF MONITORING WELL FLUID GAUGING DATA
DONA ANA DAIRIES, DONA ANA COUNTY, NEW MEXICO**

Monitoring Well	Date Measured	Northing ^a	Easting ^a	Casing Elevation ^b	Depth to Water ^c	Ground Water Elevation ^b
42-10	2-Nov-2023	421426.39	1514460.4	3929.28	120.03	3809.25
	3-Aug-2023				119.20	3810.08
	2-May-2023				118.32	3810.96
	3-Feb-2023				117.50	3811.78
	2-Nov-2022				118.25	3811.03
	2-Aug-2022				118.04	3811.24
	3-May-2022				117.20	3812.08
	8-Feb-2022				116.40	3812.88
	1-Nov-2021				117.11	3812.17
	4-Aug-2021				117.00	3812.28
	3-May-2021				116.57	3812.71
	10-Feb-2021				116.63	3812.65
	3-Nov-2020				116.93	3812.35
	10-Aug-2020				117.88	3811.40
	11-May-2020				117.22	3812.06
	5-Feb-2020				116.05	3813.23
	25-Nov-2019				116.94	3812.34
	5-Aug-2019				117.70	3811.58
	8-May-2019				117.06	3812.22
	19-Feb-2019				116.10	3813.18
	13-Nov-2018				116.55	3812.73
	6-Aug-2018				117.51	3811.77
	17-May-2018				117.25	3812.03
	6-Feb-2018				115.60	3813.68
	7-Nov-2017				116.45	3812.83
	9-Aug-2017				117.45	3811.83
	15-May-2017				117.22	3812.06
	6-Feb-2017				115.88	3813.40
	7-Nov-2016				116.40	3812.88
	15-Aug-2016				117.36	3811.92
	17-May-2016				117.40	3811.88
	9-Feb-2016				115.85	3813.43
	5-Nov-2015				116.29	3812.99
	5-Aug-2015				117.00	3812.28
	12-May-2015				116.10	3813.18
	6-Feb-2015				114.95	3814.33
	10-Nov-2014				115.52	3813.76
	14-Aug-2014				115.37	3813.91
	13-May-2014				115.15	3814.13
	12-Feb-2014				113.97	3815.31
	6-Nov-2013				115.21	3814.07
	6-Aug-2013				113.03	3816.25
	7-May-2013				112.81	3816.47
	7-Feb-2013				112.29	3816.99
	24-Oct-2012				112.95	3816.33
	31-Jul-2012				112.87	3816.41
	23-Apr-2012				111.87	3817.41
	25-Jan-2012				110.98	3818.30
	8-Dec-2011				111.16	3818.12
	19-Jul-2011				111.21	3818.07
	19-Apr-2011				110.06	3819.22
	18-Jan-2011				109.19	3820.09
	15-Sep-2010				110.24	3819.04
	27-Jun-2010				110.35	3818.93
	22-Mar-2010				109.47	3819.81
	8-Dec-2009				109.41	3819.87
	28-Aug-2009				109.67	3819.61
	26-May-2009				109.53	3819.75
	11-Dec-2008				109.00	3820.28
	27-Sep-2008				109.49	3819.79
	11-Jun-2008				109.88	3819.40
	6-Feb-2008				108.98	3820.30
	14-Nov-2007				109.36	3819.92
	12-Sep-2007				109.92	3819.36

**TABLE 1. SUMMARY OF MONITORING WELL FLUID GAUGING DATA
DONA ANA DAIRIES, DONA ANA COUNTY, NEW MEXICO**

Monitoring Well	Date Measured	Northing ^a	Easting ^a	Casing Elevation ^b	Depth to Water ^c	Ground Water Elevation ^b
42-11	2-Nov-2023	420693.98	1515270.32	3939.31	130.85	3808.46
	3-Aug-2023				130.00	3809.31
	2-May-2023				129.00	3810.31
	3-Feb-2023				128.02	3811.29
	2-Nov-2022				127.15	3812.16
	2-Aug-2022				127.20	3812.11
	3-May-2022				127.95	3811.36
	8-Feb-2022				127.03	3812.28
	1-Nov-2021				127.62	3811.69
	4-Aug-2021				127.46	3811.85
	3-May-2021				127.07	3812.24
	10-Feb-2021				126.91	3812.40
	3-Nov-2020				127.37	3811.94
	10-Aug-2020				127.65	3811.66
	11-May-2020				127.06	3812.25
	4-Feb-2020				126.66	3812.65
	8-Nov-2019				126.63	3812.68
	5-Aug-2019				127.96	3811.35
	8-May-2019				127.35	3811.96
	19-Feb-2019				126.61	3812.70
	13-Nov-2018				127.35	3811.96
	6-Aug-2018				127.90	3811.41
	17-May-2018				127.49	3811.82
	6-Feb-2018				126.31	3813.00
	7-Nov-2017				127.08	3812.23
	8-Aug-2017				127.76	3811.55
	15-May-2017				127.55	3811.76
	6-Feb-2017				126.48	3812.83
	7-Nov-2016				127.48	3811.83
	15-Aug-2016				127.82	3811.49
	17-May-2016				127.50	3811.81
	9-Feb-2016				126.40	3812.91
	5-Nov-2015				126.80	3812.51
	5-Aug-2015				127.08	3812.23
	12-May-2015				126.42	3812.89
	6-Feb-2015				125.43	3813.88
	10-Nov-2014				125.97	3813.34
	14-Aug-2014				125.85	3813.46
	13-May-2014				125.27	3814.04
	12-Feb-2014				123.96	3815.35
6-Nov-2013	125.37	3813.94				
6-Aug-2013	124.06	3815.25				
7-May-2013	123.24	3816.07				
7-Feb-2013	122.91	3816.40				
24-Oct-2012	123.44	3815.87				
31-Jul-2012	123.11	3816.20				
23-Apr-2012	122.09	3817.22				
25-Jan-2012	121.67	3817.64				
8-Dec-2011	121.83	3817.48				
19-Jul-2011	121.73	3817.58				
19-Apr-2011	120.64	3818.67				
18-Jan-2011	120.01	3819.30				
15-Sep-2010	121.02	3818.29				
27-Jun-2010	121.05	3818.26				
22-Mar-2010	120.18	3819.13				
8-Dec-2009	120.21	3819.10				
28-Aug-2009	120.51	3818.80				
26-May-2009	120.35	3818.96				
11-Dec-2008	119.88	3819.43				
27-Sep-2008	120.29	3819.02				
11-Jun-2008	120.57	3818.74				
6-Feb-2008	119.84	3819.47				
14-Nov-2007	120.24	3819.07				
12-Sep-2007	120.74	3818.57				

**TABLE 1. SUMMARY OF MONITORING WELL FLUID GAUGING DATA
DONA ANA DAIRIES, DONA ANA COUNTY, NEW MEXICO**

Monitoring Well	Date Measured	Northing ^a	Easting ^a	Casing Elevation ^b	Depth to Water ^c	Ground Water Elevation ^b		
42-12	2-Nov-2023	420972.09	1515423.88	3945.83	137.16	3808.67		
	3-Aug-2023				136.32	3809.51		
	2-May-2023				135.42	3810.41		
	3-Feb-2023				134.54	3811.29		
	2-Nov-2022				134.90	3810.93		
	2-Aug-2022				135.02	3810.81		
	3-May-2022				134.33	3811.50		
	8-Feb-2022				133.50	3812.33		
	1-Nov-2021				134.00	3811.83		
	4-Aug-2021				133.90	3811.93		
	3-May-2021				132.96	3812.87		
	10-Feb-2021				132.50	3813.33		
	3-Nov-2020				133.95	3811.88		
	10-Aug-2020				134.78	3811.05		
	11-May-2020				134.13	3811.70		
	5-Feb-2020				133.30	3812.53		
	8-Nov-2019				133.01	3812.82		
	5-Aug-2019				134.50	3811.33		
	8-May-2019				133.01	3812.82		
	19-Feb-2019				133.15	3812.68		
	13-Nov-2018				133.90	3811.93		
	6-Aug-2018				134.45	3811.38		
	17-May-2018				133.95	3811.88		
	6-Feb-2018				132.89	3812.94		
	7-Nov-2017				133.64	3812.19		
	8-Aug-2017				Not accessible			
	15-May-2017				133.90	3811.93		
	6-Feb-2017				132.92	3812.91		
	7-Nov-2016				133.88	3811.95		
	15-Aug-2016				134.14	3811.69		
	17-May-2016				133.77	3812.06		
	9-Feb-2016				132.75	3813.08		
	5-Nov-2015				133.16	3812.67		
	5-Aug-2015				134.36	3811.47		
	7-May-2015				133.05	3812.78		
	6-Feb-2015				131.76	3814.07		
	10-Nov-2014				132.31	3813.52		
	14-Aug-2014				132.13	3813.70		
	13-May-2014				131.63	3814.20		
	12-Feb-2014				129.89	3815.94		
	6-Nov-2013				131.11	3814.72		
	6-Aug-2013				130.08	3815.75		
	7-May-2013				129.59	3816.24		
	7-Feb-2013				129.18	3816.65		
	24-Oct-2012				129.74	3816.09		
	31-Jul-2012				129.44	3816.39		
	23-Apr-2012				128.71	3817.12		
25-Jan-2012	128.06	3817.77						
8-Dec-2011	128.14	3817.69						
19-Jul-2011	128.01	3817.82						
19-Apr-2011	126.37	3819.46						
18-Jan-2011	126.37	3819.46						
15-Sep-2010	127.38	3818.45						
27-Jun-2010	127.43	3818.40						
22-Mar-2010	126.50	3819.33						
8-Dec-2009	126.60	3819.23						
28-Aug-2009	126.84	3818.99						
26-May-2009	126.68	3819.15						
11-Dec-2008	126.18	3819.65						
27-Sep-2008	126.68	3819.15						
11-Jun-2008	126.88	3818.95						
6-Feb-2008	126.16	3819.67						
14-Nov-2007	126.55	3819.28						
12-Sep-2007	127.04	3818.79						

**TABLE 1. SUMMARY OF MONITORING WELL FLUID GAUGING DATA
DONA ANA DAIRIES, DONA ANA COUNTY, NEW MEXICO**

Monitoring Well	Date Measured	Northing ^a	Easting ^a	Casing Elevation ^b	Depth to Water ^c	Ground Water Elevation ^b
42-13	2-Nov-2023	419734.06	1512534.42	3873.10	61.95	3811.15
	3-Aug-2023				61.00	3812.10
	2-May-2023				60.01	3813.09
	2-Feb-2023				59.06	3814.04
	1-Nov-2022				58.81	3814.29
	2-Aug-2022				58.90	3814.20
	3-May-2022				59.28	3813.82
	7-Feb-2022				58.97	3814.13
	1-Nov-2021				58.53	3814.57
	4-Aug-2021				58.00	3815.10
	3-May-2021				58.10	3815.00
	10-Feb-2021				57.91	3815.19
	2-Nov-2020				58.66	3814.44
	10-Aug-2020				59.05	3814.05
	11-May-2020				59.66	3813.44
	4-Feb-2020				58.05	3815.05
	8-Nov-2019				57.05	3816.05
	5-Aug-2019				58.25	3814.85
	8-May-2019				58.22	3814.88
	19-Feb-2019				58.10	3815.00
	13-Nov-2018				57.70	3815.40
	6-Aug-2018				57.18	3815.92
	17-May-2018				58.70	3814.40
	6-Feb-2017				57.77	3815.33
	7-Nov-2017				57.98	3815.12
	8-Aug-2017				58.75	3814.35
	15-May-2017				59.15	3813.95
	6-Feb-2017				58.90	3814.20
	7-Nov-2016				59.00	3814.10
	15-Aug-2016				59.40	3813.70
	17-May-2016				59.73	3813.37
	9-Feb-2016				59.30	3813.80
	5-Nov-2015				59.28	3813.82
	5-Aug-2015				59.04	3814.06
	7-May-2015				59.37	3813.73
	5-Feb-2015				58.50	3814.60
	10-Nov-2014				57.27	3815.83
	12-Aug-2014				57.56	3815.54
	13-May-2014				57.95	3815.15
	17-Feb-2014				57.38	3815.72
6-Nov-2013	56.31	3816.79				
6-Aug-2013	56.01	3817.09				
7-May-2013	56.02	3817.08				
7-Feb-2013	55.86	3817.24				
24-Oct-2012	55.40	3817.70				
31-Jul-2012	55.17	3817.93				
23-Apr-2012	54.96	3818.14				
25-Jan-2012	54.99	3818.11				
8-Dec-2011	54.83	3818.27				
19-Jul-2011	53.77	3819.33				
19-Apr-2011	53.50	3819.60				
18-Jan-2011	52.95	3820.15				
15-Sep-2010	52.44	3820.66				
24-Jun-2010	53.21	3819.89				
22-Mar-2010	52.84	3820.26				
8-Dec-2009	52.79	3820.31				
28-Aug-2009	52.45	3820.65				
26-May-2009	52.64	3820.46				
11-Dec-2008	52.49	3820.61				
27-Sep-2008	52.23	3820.87				
10-Jun-2008	52.91	3820.19				
6-Feb-2008	52.84	3820.26				
13-Nov-2007	52.56	3820.54				
12-Sep-2007	52.83	3820.27				

**TABLE 1. SUMMARY OF MONITORING WELL FLUID GAUGING DATA
DONA ANA DAIRIES, DONA ANA COUNTY, NEW MEXICO**

Monitoring Well	Date Measured	Northing ^a	Easting ^a	Casing Elevation ^b	Depth to Water ^c	Ground Water Elevation ^b
Dominguez Dairy						
624-01	2-Nov-2023	418826.21	1512131.46	3843.72	30.38	3813.34
	3-Aug-2023				29.52	3814.20
	2-May-2023				30.70	3813.02
	3-Feb-2023				29.80	3813.92
	2-Nov-2022				29.05	3814.67
	2-Aug-2022				28.18	3815.54
	3-May-2022				28.80	3814.92
	8-Feb-2022				28.95	3814.77
	2-Nov-2021				28.08	3815.64
	5-Aug-2021				27.22	3816.50
	4-May-2021				27.13	3816.59
	11-Feb-2021				26.27	3817.45
	3-Nov-2020				25.95	3817.77
	11-Aug-2020				26.11	3817.61
	11-May-2020				26.96	3816.76
	5-Feb-2020				27.62	3816.10
	8-Nov-2019				26.82	3816.90
	1-Aug-2019				27.30	3816.42
	8-May-2019				26.50	3817.22
	19-Feb-2019				27.80	3815.92
	12-Nov-2018				27.03	3816.69
	6-Aug-2018				24.25	3819.47
	14-May-2018				26.91	3816.81
	5-Feb-2018				27.43	3816.29
	6-Nov-2017				27.11	3816.61
	7-Aug-2017				27.76	3815.96
	15-May-2017				28.08	3815.64
	7-Feb-2017				29.10	3814.62
	7-Nov-2016				28.41	3815.31
	15-Aug-2016				28.49	3815.23
	16-May-2016				28.53	3815.19
	9-Feb-2016				29.47	3814.25
	5-Nov-2015				29.23	3814.49
	5-Aug-2015				28.20	3815.52
	6-May-2015				28.06	3815.66
	5-Feb-2015				28.95	3814.77
	10-Nov-2014				28.24	3815.48
	12-Aug-2014				26.64	3817.08
	12-May-2014				27.38	3816.34
	12-Feb-2014				28.10	3815.62
7-Nov-2013	26.34	3817.38				
6-Aug-2013	25.98	3817.74				
7-May-2013	26.21	3817.51				
7-Feb-2013	26.39	3817.33				
24-Oct-2012	25.89	3817.83				
30-Jul-2012	26.12	3817.60				
24-Apr-2012	26.02	3817.70				
25-Jan-2012	25.51	3818.21				
7-Dec-2011	25.19	3818.53				
19-Jul-2011	23.22	3820.50				
19-Apr-2011	23.75	3819.97				
18-Jan-2011	23.53	3820.19				
15-Sep-2010	21.40	3822.32				
24-Jun-2010	22.48	3821.24				
22-Mar-2010	22.83	3820.89				
8-Dec-2009	23.33	3820.39				
28-Aug-2009	22.72	3821.00				
27-May-2009	22.92	3820.80				
11-Dec-2008	23.11	3820.61				
27-Sep-2008	22.62	3821.10				
10-Jun-2008	22.72	3821.00				
5-Feb-2008	23.64	3820.08				
13-Nov-2007	22.87	3820.85				
12-Sep-2007	22.94	3820.78				

**TABLE 1. SUMMARY OF MONITORING WELL FLUID GAUGING DATA
DONA ANA DAIRIES, DONA ANA COUNTY, NEW MEXICO**

Monitoring Well	Date Measured	Northing ^a	Easting ^a	Casing Elevation ^b	Depth to Water ^c	Ground Water Elevation ^b
624-02	2-Nov-2023	417335.25	1512201.42	3835.45	22.11	3813.34
	3-Aug-2023				21.20	3814.25
	2-May-2023				22.32	3813.13
	3-Feb-2023				21.96	3813.49
	2-Nov-2022				21.20	3814.25
	2-Aug-2022				19.69	3815.76
	3-May-2022				20.50	3814.95
	8-Feb-2022				20.90	3814.55
	2-Nov-2021				20.10	3815.35
	5-Aug-2021				19.47	3815.98
	4-May-2021				19.30	3816.15
	11-Feb-2021				18.88	3816.57
	3-Nov-2020				17.89	3817.56
	11-Aug-2020				18.39	3817.06
	11-May-2020				19.89	3815.56
	5-Feb-2020				19.00	3816.45
	8-Nov-2019				17.77	3817.68
	1-Aug-2019				18.65	3816.80
	8-May-2019				18.42	3817.03
	19-Feb-2019				18.42	3817.03
	12-Nov-2018				18.67	3816.78
	6-Aug-2018				14.48	3820.97
	14-May-2018				19.04	3816.41
	5-Feb-2017				19.15	3816.30
	6-Nov-2017				18.33	3817.12
	8-Aug-2017				18.42	3817.03
	15-May-2017				19.94	3815.51
	7-Feb-2017				20.87	3814.58
	7-Nov-2016				19.47	3815.98
	15-Aug-2016				19.06	3816.39
	16-May-2016				20.57	3814.88
	9-Feb-2016				21.36	3814.09
	5-Nov-2015				20.82	3814.63
	5-Aug-2015				19.45	3816.00
	6-May-2015				19.81	3815.64
	5-Feb-2015				20.95	3814.50
	6-Nov-2014				19.65	3815.80
	12-Aug-2014				19.12	3816.33
	12-May-2014				19.00	3816.45
	12-Feb-2014				20.00	3815.45
7-Nov-2013	18.60	3816.85				
6-Aug-2013	18.83	3816.62				
7-May-2013	19.01	3816.44				
7-Feb-2013	19.10	3816.35				
24-Oct-2012	18.85	3816.60				
30-Jul-2012	18.59	3816.86				
23-Apr-2012	17.97	3817.48				
24-Jan-2012	17.16	3818.29				
7-Dec-2011	17.30	3818.15				
19-Jul-2011	15.23	3820.22				
19-Apr-2011	15.94	3819.51				
17-Jan-2011	15.66	3819.79				
20-Sep-2010	14.04	3821.41				
24-Jun-2010	13.93	3821.52				
22-Mar-2010	15.24	3820.21				
8-Dec-2009	15.61	3819.84				
28-Aug-2009	14.85	3820.60				
27-May-2009	15.14	3820.31				
11-Dec-2008	15.47	3819.98				
27-Sep-2008	14.97	3820.48				
10-Jun-2008	14.87	3820.58				
5-Feb-2008	16.50	3818.95				
13-Nov-2007	15.40	3820.05				
12-Sep-2007	14.94	3820.51				

**TABLE 1. SUMMARY OF MONITORING WELL FLUID GAUGING DATA
DONA ANA DAIRIES, DONA ANA COUNTY, NEW MEXICO**

Monitoring Well	Date Measured	Northing ^a	Easting ^a	Casing Elevation ^b	Depth to Water ^c	Ground Water Elevation ^b
624-04	28-Jan-2020	418542.24	1508104.07	3835.69	Plugged and Abandoned	
	8-Nov-2019				Dry	
	1-Aug-2019				Dry	
	8-May-2019				Dry	
	19-Feb-2019				Dry	
	12-Nov-2018				Dry	
	6-Aug-2018				Dry	
	14-May-2018				Dry	
	5-Feb-2017				Dry	
	6-Nov-2017				Dry	
	7-Aug-2017				Dry	
	15-May-2017				Dry	
	7-Feb-2017				Dry	
	7-Nov-2016				Dry	
	15-Aug-2016				Dry	
	16-May-2016				Dry	
	9-Feb-2016				Dry	
	5-Nov-2015				Dry	
	5-Aug-2015				Dry	
	6-May-2015				Dry	
	5-Feb-2015				Dry	
	6-Nov-2014				Dry	
	12-Aug-2014				Dry	
	12-May-2014				Dry	
	12-Feb-2014				Dry	
	7-Nov-2013				Dry	
	6-Aug-2013				Dry	
	7-May-2013				Dry	
	7-Feb-2013				Dry	
	24-Oct-2012				Dry	
	30-Jul-2012				Dry	
	23-Apr-2012				Dry	
	25-Jan-2012				Dry	
	8-Dec-2011				Dry	
	19-Jul-2011				15.39	3820.30
	19-Apr-2011				13.66	3822.03
	18-Jan-2011				13.99	3821.70
	15-Sep-2010				11.43	3824.26
	24-Jun-2010				13.49	3822.20
	22-Mar-2010				14.83	3820.86
8-Dec-2009	13.48	3822.21				
28-Aug-2009	12.49	3823.20				
26-May-2009	12.89	3822.80				
11-Dec-2008	12.99	3822.70				
27-Sep-2008	12.31	3823.38				
10-Jun-2008	14.45	3821.24				
5-Feb-2008	14.13	3821.56				
13-Nov-2007	13.60	3822.09				
12-Sep-2007	14.83	3820.86				

**TABLE 1. SUMMARY OF MONITORING WELL FLUID GAUGING DATA
DONA ANA DAIRIES, DONA ANA COUNTY, NEW MEXICO**

Monitoring Well	Date Measured	Northing ^a	Easting ^a	Casing Elevation ^b	Depth to Water ^c	Ground Water Elevation ^b
624-05	28-Jan-2020	419777.52	1509829.65	3835.27	Plugged and Abandoned	
	8-Nov-2019				15.87	3819.40
	1-Aug-2019				16.00	3819.27
	8-May-2019				16.60	3818.67
	19-Feb-2019				16.81	3818.46
	12-Nov-2018				Dry	
	6-Aug-2018				Dry	
	14-May-2018				Dry	
	5-Feb-2017				Dry	
	6-Nov-2017				Dry	
	7-Aug-2017				Dry	
	15-May-2017				Dry	
	7-Feb-2017				Dry	
	7-Nov-2016				Dry	
	15-Aug-2016				Dry	
	16-May-2016				Dry	
	9-Feb-2016				Dry	
	5-Nov-2015				Dry	
	5-Aug-2015				Dry	
	6-May-2015				Dry	
	5-Feb-2015				Dry	
	6-Nov-2014				Dry	
	12-Aug-2014				Dry	
	12-May-2014				Dry	
	12-Feb-2014				Dry	
	7-Nov-2013				Dry	
	6-Aug-2013				Dry	
	7-May-2013				Dry	
	7-Feb-2013				16.72	3818.55
	24-Oct-2012				16.35	3818.92
	30-Jul-2012				15.89	3819.38
	23-Apr-2012				15.90	3819.37
	25-Jan-2012				15.81	3819.46
	7-Dec-2011				15.25	3820.02
	3-Aug-2011				13.38	3821.89
	19-Apr-2011				13.86	3821.41
	18-Jan-2011				13.11	3822.16
	15-Sep-2010				12.01	3823.26
	24-Jun-2010				12.71	3822.56
	22-Mar-2010				13.21	3822.06
8-Dec-2009	12.54	3822.73				
28-Aug-2009	12.03	3823.24				
26-May-2009	12.58	3822.69				
11-Dec-2008	12.82	3822.45				
27-Sep-2008	11.97	3823.30				
10-Jun-2008	13.19	3822.08				
5-Feb-2008	13.44	3821.83				
13-Nov-2007	13.01	3822.26				
12-Sep-2007	13.31	3821.96				

**TABLE 1. SUMMARY OF MONITORING WELL FLUID GAUGING DATA
DONA ANA DAIRIES, DONA ANA COUNTY, NEW MEXICO**

Monitoring Well	Date Measured	Northing ^a	Easting ^a	Casing Elevation ^b	Depth to Water ^c	Ground Water Elevation ^b
624-06	28-Jan-2020	418502.42	1513981.08	3868.18	Plugged and Abandoned	
	8-Nov-2019				Dry	
	1-Aug-2019				Dry	
	8-May-2019				Dry	
	19-Feb-2019				Dry	
	12-Nov-2018				Dry	
	6-Aug-2018				Dry	
	14-May-2018				Dry	
	5-Feb-2017				Dry	
	6-Nov-2017				Dry	
	7-Aug-2017				Dry	
	15-May-2017				Dry	
	7-Feb-2017				Dry	
	7-Nov-2016				Dry	
	15-Aug-2016				Dry	
	16-May-2016				Dry	
	9-Feb-2016				Dry	
	5-Nov-2015				Dry	
	5-Aug-2015				Dry	
	6-May-2015				Dry	
	5-Feb-2015				Dry	
	6-Nov-2014				Dry	
	12-Aug-2014				Dry	
	12-May-2014				Dry	
	12-Feb-2014				Dry	
	7-Nov-2013				Dry	
	6-Aug-2013				Dry	
	7-May-2013				Dry	
	7-Feb-2013				51.84	3816.34
	24-Oct-2012				51.99	3816.19
	30-Jul-2012				51.30	3816.88
	23-Apr-2012				51.83	3816.35
	25-Jan-2012				51.80	3816.38
	13-Dec-2011				50.89	3817.29
	19-Jul-2011				50.43	3817.75
	19-Apr-2011				49.79	3818.39
	18-Jan-2011				49.31	3818.87
	21-Sep-2010				48.73	3819.45
	24-Jun-2010				50.33	3817.85
	22-Mar-2010				49.62	3818.56
8-Dec-2009	48.96	3819.22				
28-Aug-2009	48.87	3819.31				
26-May-2009	49.14	3819.04				
11-Dec-2008	48.89	3819.29				
27-Sep-2008	48.71	3819.47				
10-Jun-2008	49.67	3818.51				
5-Feb-2008	49.11	3819.07				
13-Nov-2007	48.94	3819.24				
12-Sep-2007	49.17	3819.01				

**TABLE 1. SUMMARY OF MONITORING WELL FLUID GAUGING DATA
DONA ANA DAIRIES, DONA ANA COUNTY, NEW MEXICO**

Monitoring Well	Date Measured	Northing ^a	Easting ^a	Casing Elevation ^b	Depth to Water ^c	Ground Water Elevation ^b
624-07	28-Jan-2020	418012.23	1514707.77	3872.25	Plugged and Abandoned	
	8-Nov-2019				Dry	
	1-Aug-2019				Dry	
	8-May-2019				Dry	
	19-Feb-2019				Dry	
	12-Nov-2018				Dry	
	6-Aug-2018				Dry	
	14-May-2018				Dry	
	5-Feb-2017				Dry	
	6-Nov-2017				Dry	
	7-Aug-2017				55.68	3816.57
	15-May-2017				55.66	3816.59
	7-Feb-2017				55.67	3816.58
	7-Nov-2016				55.65	3816.60
	15-Aug-2016				55.60	3816.65
	20-May-2016				55.66	3816.59
	9-Feb-2016				Dry	
	5-Nov-2015				55.60	3816.65
	5-Aug-2015				55.56	3816.69
	6-May-2015				55.57	3816.68
	5-Feb-2015				55.53	3816.72
	6-Nov-2014				55.57	3816.68
	12-Aug-2014				55.68	3816.57
	12-May-2014				55.61	3816.64
	12-Feb-2014				55.62	3816.63
	7-Nov-2013				Dry	
	6-Aug-2013				Dry	
	7-May-2013				Dry	
	7-Feb-2013				Dry	
	24-Oct-2012				55.58	3816.67
	30-Jul-2012				55.47	3816.78
	23-Apr-2012				Dry	
	25-Jan-2012				55.50	3816.75
	13-Dec-2011				55.46	3816.79
	19-Jul-2011				54.55	3817.70
	19-Apr-2011				54.64	3817.61
	18-Jan-2011				53.91	3818.34
	15-Sep-2010				52.30	3819.95
	24-Jun-2010				55.27	3816.98
	22-Mar-2010				54.21	3818.04
8-Dec-2009	53.32	3818.93				
28-Aug-2009	53.22	3819.03				
26-May-2009	53.76	3818.49				
11-Dec-2008	53.59	3818.66				
27-Sep-2008	53.35	3818.90				
10-Jun-2008	54.34	3817.91				
5-Feb-2008	53.81	3818.44				
13-Nov-2007	53.26	3818.99				
12-Sep-2007	53.03	3819.22				

**TABLE 1. SUMMARY OF MONITORING WELL FLUID GAUGING DATA
DONA ANA DAIRIES, DONA ANA COUNTY, NEW MEXICO**

Monitoring Well	Date Measured	Northing ^a	Easting ^a	Casing Elevation ^b	Depth to Water ^c	Ground Water Elevation ^b
624-08	28-Jan-2020	421461.78	1507712.04	3838.70	Plugged and Abandoned	
	8-Nov-2019				Dry	
	1-Aug-2019				Dry	
	8-May-2019				Dry	
	19-Feb-2019				Dry	
	12-Nov-2018				Dry	
	6-Aug-2018				Dry	
	14-May-2018				Dry	
	5-Feb-2017				Dry	
	6-Nov-2017				Dry	
	7-Aug-2017				Dry	
	15-May-2017				Dry	
	7-Feb-2017				Dry	
	7-Nov-2016				Dry	
	15-Aug-2016				Dry	
	16-May-2016				Dry	
	9-Feb-2016				Dry	
	5-Nov-2015				Dry	
	5-Aug-2015				Dry	
	6-May-2015				Dry	
	5-Feb-2015				Dry	
	6-Nov-2014				Dry	
	12-Aug-2014				Dry	
	12-May-2014				Dry	
	12-Feb-2014				Dry	
	7-Nov-2013				Dry	
	6-Aug-2013				Dry	
	7-May-2013				Dry	
	7-Feb-2013				Dry	
	24-Oct-2012				Dry	
	30-Jul-2012				Dry	
	23-Apr-2012				Dry	
	25-Jan-2012				Dry	
	8-Dec-2011				Dry	
	3-Aug-2011				Dry	
	18-Apr-2011				17.72	3820.98
	18-Jan-2011				16.03	3822.67
	14-Sep-2010				14.83	3823.87
	24-Jun-2010				16.44	3822.26
	22-Mar-2010				16.42	3822.28
8-Dec-2009	16.02	3822.68				
28-Aug-2009	15.20	3823.50				
26-May-2009	15.54	3823.16				
11-Dec-2008	14.96	3823.74				
27-Sep-2008	14.84	3823.86				
10-Jun-2008	16.12	3822.58				
5-Feb-2008	15.37	3823.33				
13-Nov-2007	14.71	3823.99				
12-Sep-2007	15.33	3823.37				

**TABLE 1. SUMMARY OF MONITORING WELL FLUID GAUGING DATA
DONA ANA DAIRIES, DONA ANA COUNTY, NEW MEXICO**

Monitoring Well	Date Measured	Northing ^a	Easting ^a	Casing Elevation ^b	Depth to Water ^c	Ground Water Elevation ^b
624-09	2-Nov-2023	421471.18	1503801.31	3838.25	26.20	3812.05
	3-Aug-2023				25.31	3812.94
	1-May-2023				25.20	3813.05
	3-Feb-2023				23.87	3814.38
	2-Nov-2022				24.15	3814.10
	2-Aug-2022				23.47	3814.78
	3-May-2022				22.69	3815.56
	8-Feb-2022				21.87	3816.38
	4-Nov-2021				22.31	3815.94
	5-Aug-2021				22.43	3815.82
	4-May-2021				18.39	3819.86
	11-Feb-2021				17.42	3820.83
	3-Nov-2020				17.02	3821.23
	11-Aug-2020				17.20	3821.05
	11-May-2020				18.85	3819.40
12-Feb-2020	17.35	3820.90				
624-10	2-Nov-2023	421500.79	1507673.92	3839.50	27.30	3812.20
	3-Aug-2023				26.44	3813.06
	1-May-2023				25.71	3813.79
	3-Feb-2023				24.83	3814.67
	2-Nov-2022				24.02	3815.48
	2-Aug-2022				23.40	3816.10
	3-May-2022				22.89	3816.61
	8-Feb-2022				22.00	3817.50
	4-Nov-2021				21.06	3818.44
	5-Aug-2021				20.32	3819.18
	4-May-2021				22.80	3816.70
	11-Feb-2021				21.32	3818.18
	3-Nov-2020				21.22	3818.28
	11-Aug-2020				21.63	3817.87
	11-May-2020				22.98	3816.52
12-Feb-2020	21.34	3818.16				
624-11	2-Nov-2023	418501.93	1514076.76	3867.13	56.40	3810.73
	3-Aug-2023				55.63	3811.50
	2-May-2023				56.12	3811.01
	3-Feb-2023				55.27	3811.86
	2-Nov-2022				55.45	3811.68
	2-Aug-2022				55.10	3812.03
	3-May-2022				54.61	3812.52
	8-Feb-2022				54.20	3812.93
	4-Nov-2021				54.16	3812.97
	5-Aug-2021				54.17	3812.96
	4-May-2021				54.05	3813.08
	11-Feb-2021				53.34	3813.79
	3-Nov-2020				53.08	3814.05
	11-Aug-2020				53.52	3813.61
	11-May-2020				54.10	3813.03
12-Feb-2020	53.35	3813.78				

**TABLE 1. SUMMARY OF MONITORING WELL FLUID GAUGING DATA
DONA ANA DAIRIES, DONA ANA COUNTY, NEW MEXICO**

Monitoring Well	Date Measured	Northing ^a	Easting ^a	Casing Elevation ^b	Depth to Water ^c	Ground Water Elevation ^b
Gonzalez Dairy						
177-01	11-May-2020	417300.94	1512942.63	3834.27	18.60	3815.67
	5-Feb-2020				18.96	3815.31
	8-Nov-2019				17.55	3816.72
	1-Aug-2019				18.86	3815.41
	8-May-2019				18.60	3815.67
	19-Feb-2019				19.14	3815.13
	12-Nov-2018				18.40	3815.87
	6-Aug-2018				16.00	3818.27
	17-May-2018				19.18	3815.09
	5-Feb-2018				18.80	3815.47
	6-Nov-2017				18.32	3815.95
	8-Aug-2017				18.57	3815.70
	15-May-2017				19.76	3814.51
	7-Feb-2017				20.20	3814.07
	7-Nov-2016				19.25	3815.02
	15-Aug-2016				18.95	3815.32
	16-May-2016				20.48	3813.79
	9-Feb-2016				20.66	3813.61
	5-Nov-2015				20.22	3814.05
	13-Aug-2015				19.21	3815.06
	6-May-2015				19.40	3814.87
	6-Feb-2015				20.14	3814.13
	10-Nov-2014				19.12	3815.15
	13-Aug-2014				17.33	3816.94
	13-May-2014				18.53	3815.74
	12-Feb-2014				19.05	3815.22
	7-Nov-2013				17.97	3816.30
	6-Aug-2013				17.01	3817.26
	7-May-2013				17.81	3816.46
	7-Feb-2013				17.77	3816.50
	25-Oct-2012				15.91	3818.36
	30-Jul-2012				14.88	3819.39
	23-Apr-2012				16.32	3817.95
	26-Jan-2012				16.71	3817.56
	7-Dec-2011				16.36	3817.91
	19-Jul-2011				14.64	3819.63
	19-Apr-2011				14.84	3819.43
	17-Jan-2011				14.43	3819.84
	15-Sep-2010				13.30	3820.97
	23-Jun-2010				14.11	3820.16
	22-Mar-2010				14.75	3819.52
	8-Dec-2009				14.68	3819.59
	28-Aug-2009				14.16	3820.11
	26-May-2009				14.35	3819.92
	10-Dec-2008				14.64	3819.63
	27-Sep-2008				14.21	3820.06
	10-Jun-2008				14.50	3819.77
	6-Feb-2008				15.06	3819.21
	13-Nov-2007				14.53	3819.74
	13-Sep-2007				14.03	3820.24

**TABLE 1. SUMMARY OF MONITORING WELL FLUID GAUGING DATA
DONA ANA DAIRIES, DONA ANA COUNTY, NEW MEXICO**

Monitoring Well	Date Measured	Northing ^a	Easting ^a	Casing Elevation ^b	Depth to Water ^c	Ground Water Elevation ^b
177-02	11-May-2020	416738.21	1513246.51	3834.66	19.56	3815.10
	5-Feb-2020				19.40	3815.26
	8-Nov-2019				19.02	3815.64
	1-Aug-2019				19.38	3815.28
	8-May-2019				19.50	3815.16
	19-Feb-2019				19.58	3815.08
	12-Nov-2018				19.20	3815.46
	6-Aug-2018				17.05	3817.61
	17-May-2018				20.00	3814.66
	5-Feb-2018				19.45	3815.21
	6-Nov-2017				19.05	3815.61
	8-Aug-2017				19.17	3815.49
	15-May-2017				20.63	3814.03
	7-Feb-2017				20.91	3813.75
	7-Nov-2016				19.95	3814.71
	15-Aug-2016				19.50	3815.16
	16-May-2016				21.35	3813.31
	9-Feb-2016				21.33	3813.33
	5-Nov-2015				20.88	3813.78
	5-Aug-2015				19.91	3814.75
	6-May-2015				20.13	3814.53
	6-Feb-2015				20.75	3813.91
	10-Nov-2014				19.80	3814.86
	13-Aug-2014				18.21	3816.45
	13-May-2014				19.24	3815.42
	12-Feb-2014				19.72	3814.94
	7-Nov-2013				18.66	3816.00
	6-Aug-2013				18.30	3816.36
	7-May-2013				18.69	3815.97
	7-Feb-2013				18.50	3816.16
	25-Oct-2012				17.35	3817.31
	30-Jul-2012				17.80	3816.86
	24-Jan-2012				17.61	3817.05
	7-Dec-2011				16.92	3817.74
	19-Jul-2011				15.41	3819.25
	19-Apr-2011				15.47	3819.19
	17-Jan-2011				14.94	3819.72
	15-Sep-2010				14.23	3820.43
	23-Jun-2010				14.86	3819.80
	22-Mar-2010				15.59	3819.07
	8-Dec-2009				15.29	3819.37
	28-Aug-2009				14.90	3819.76
	26-May-2009				15.09	3819.57
	10-Dec-2008				15.37	3819.29
	27-Sep-2008				14.95	3819.71
	10-Jun-2008				15.41	3819.25
	6-Feb-2008				15.74	3818.92
	13-Nov-2007				15.39	3819.27
	13-Sep-2007				14.72	3819.94

**TABLE 1. SUMMARY OF MONITORING WELL FLUID GAUGING DATA
DONA ANA DAIRIES, DONA ANA COUNTY, NEW MEXICO**

Monitoring Well	Date Measured	Northing ^a	Easting ^a	Casing Elevation ^b	Depth to Water ^c	Ground Water Elevation ^b
177-03A	11-May-2020	416206.71	1513777.17	3835.75	21.76	3813.99
	5-Feb-2020				21.30	3814.45
	8-Nov-2019				20.86	3814.89
	1-Aug-2019				21.35	3814.40
	8-May-2019				21.70	3814.05
	19-Feb-2019				21.10	3814.65
	12-Nov-2018				21.20	3814.55
	6-Aug-2018				20.54	3815.21
	17-May-2018				21.90	3813.85
	5-Feb-2018				21.15	3814.60
	6-Nov-2017				20.89	3814.86
	8-Aug-2017				21.23	3814.52
	15-May-2017				22.55	3813.20
	7-Feb-2017				22.52	3813.23
	7-Nov-2016				21.97	3813.78
	15-Aug-2016				21.90	3813.85
	16-May-2016				23.26	3812.49
	9-Feb-2016				22.91	3812.84
	5-Nov-2015				22.68	3813.07
	5-Aug-2015				22.05	3813.70
	6-May-2015				22.26	3813.49
	6-Feb-2015				22.30	3813.45
	10-Nov-2014				21.61	3814.14
	13-Aug-2014				20.51	3815.24
	12-May-2014				21.60	3814.15
	12-Feb-2014				21.41	3814.34
	7-Nov-2013				20.29	3815.46
	6-Aug-2013				19.99	3815.76
	7-May-2013				20.53	3815.22
	7-Feb-2013				20.01	3815.74
25-Oct-2012	19.18	3816.57				
30-Jul-2012	18.24	3817.51				
24-Apr-2012	18.57	3817.18				
24-Jan-2012	18.63	3817.12				
13-Dec-2011	18.51	3817.24				

**TABLE 1. SUMMARY OF MONITORING WELL FLUID GAUGING DATA
DONA ANA DAIRIES, DONA ANA COUNTY, NEW MEXICO**

Monitoring Well	Date Measured	Northing ^a	Easting ^a	Casing Elevation ^b	Depth to Water ^c	Ground Water Elevation ^b
177-04	12-May-2020	416796.99	1513733.28	3840.33	25.90	3814.43
	5-Feb-2020				25.10	3815.23
	8-Nov-2019				24.89	3815.44
	1-Aug-2019				25.88	3814.45
	8-May-2019				25.81	3814.52
	19-Feb-2019				24.75	3815.58
	12-Nov-2018				24.35	3815.98
	6-Aug-2018				24.29	3816.04
	17-May-2018				26.17	3814.16
	5-Feb-2018				25.52	3814.81
	6-Nov-2017				25.30	3815.03
	16-Aug-2017				25.27	3815.06
	15-May-2017				26.80	3813.53
	7-Feb-2017				26.85	3813.48
	7-Nov-2016				26.21	3814.12
	15-Aug-2016				26.13	3814.20
	16-May-2016				27.45	3812.88
	9-Feb-2016				27.84	3812.49
	5-Nov-2015				26.89	3813.44
	5-Aug-2015				26.25	3814.08
	6-May-2015				26.49	3813.84
	6-Feb-2015				26.58	3813.75
	10-Nov-2014				25.75	3814.58
	13-Aug-2014				24.52	3815.81
	13-May-2014				25.46	3814.87
	12-Feb-2014				25.62	3814.71
	7-Nov-2013				24.75	3815.58
	6-Aug-2013				24.12	3816.21
	7-May-2013				24.67	3815.66
	7-Feb-2013				24.29	3816.04
	25-Oct-2012				23.49	3816.84
	30-Jul-2012				22.68	3817.65
	24-Apr-2012				23.36	3816.97
	24-Jan-2012				22.47	3817.86
	7-Dec-2011				22.97	3817.36
	19-Jul-2011				21.66	3818.67
	19-Apr-2011				21.41	3818.92
	17-Jan-2011				21.22	3819.11
	15-Sep-2010				20.36	3819.97
	23-Jun-2010				21.05	3819.28
	22-Mar-2010				21.71	3818.62
	8-Dec-2009				21.14	3819.19
	28-Aug-2009				20.86	3819.47
	27-May-2009				21.13	3819.20
	10-Dec-2008				21.37	3818.96
	27-Sep-2008				20.86	3819.47
	10-Jun-2008				21.63	3818.70
	6-Feb-2008				21.59	3818.74
	13-Nov-2007				21.30	3819.03
	13-Sep-2007				20.84	3819.49

**TABLE 1. SUMMARY OF MONITORING WELL FLUID GAUGING DATA
DONA ANA DAIRIES, DONA ANA COUNTY, NEW MEXICO**

Monitoring Well	Date Measured	Northing ^a	Easting ^a	Casing Elevation ^b	Depth to Water ^c	Ground Water Elevation ^b
177-05	12-May-2020	417302.42	1514116.55	3852.16	38.40	3813.76
	5-Feb-2020				38.02	3814.14
	8-Nov-2019				37.30	3814.86
	1-Aug-2019				38.59	3813.57
	8-May-2019				38.30	3813.86
	19-Feb-2019				38.20	3813.96
	12-Nov-2018				37.63	3814.53
	6-Aug-2018				37.30	3814.86
	17-May-2018				38.60	3813.56
	5-Feb-2018				37.80	3814.36
	6-Nov-2017				37.78	3814.38
	8-Aug-2017				38.26	3813.90
	15-May-2017				39.16	3813.00
	7-Feb-2017				38.95	3813.21
	7-Nov-2016				38.58	3813.58
	15-Aug-2016				38.84	3813.32
	16-May-2016				39.71	3812.45
	9-Feb-2016				39.25	3812.91
	5-Nov-2015				38.90	3813.26
	5-Aug-2015				38.65	3813.51
	6-May-2015				38.97	3813.19
	6-Feb-2015				38.48	3813.68
	10-Nov-2014				37.80	3814.36
	13-Aug-2014				36.70	3815.46
	13-May-2014				37.60	3814.56
	12-Feb-2014				37.51	3814.65
	6-Nov-2013				36.95	3815.21
	6-Aug-2013				36.02	3816.14
	7-May-2013				36.74	3815.42
	7-Feb-2013				36.21	3815.95
	25-Oct-2012				35.72	3816.44
	30-Jul-2012				36.39	3815.77
	24-Apr-2012				36.04	3816.12
	24-Jan-2012				35.02	3817.14
	7-Dec-2011				35.19	3816.97
	19-Jul-2011				34.07	3818.09
	19-Apr-2011				32.91	3819.25
	17-Jan-2011				33.72	3818.44
	15-Sep-2010				32.68	3819.48
	23-Jun-2010				33.59	3818.57
	22-Mar-2010				34.10	3818.06
	8-Dec-2009				33.22	3818.94
	28-Aug-2009				32.95	3819.21
	26-May-2009				33.26	3818.90
	10-Dec-2008				33.60	3818.56
	27-Sep-2008				32.95	3819.21
	10-Jun-2008				33.96	3818.20
	6-Feb-2008				33.58	3818.58
	13-Nov-2007				33.27	3818.89
	13-Sep-2007				33.12	3819.04

**TABLE 1. SUMMARY OF MONITORING WELL FLUID GAUGING DATA
DONA ANA DAIRIES, DONA ANA COUNTY, NEW MEXICO**

Monitoring Well	Date Measured	Northing ^a	Easting ^a	Casing Elevation ^b	Depth to Water ^c	Ground Water Elevation ^b
177-06	12-May-2020	417301.84	1514765.63	3866.02	Dry	
	5-Feb-2020				Dry	
	8-Nov-2019				Dry	
	1-Aug-2019				Dry	
	8-May-2019				Dry	
	19-Feb-2019				Dry	
	12-Nov-2018				Dry	
	6-Aug-2018				Dry	
	17-May-2018				Dry	
	5-Feb-2018				Dry	
	6-Nov-2017				Dry	
	8-Aug-2017				Dry	
	15-May-2017				Dry	
	7-Feb-2017				Dry	
	7-Nov-2016				Dry	
	15-Aug-2016				Dry	
	16-May-2016				Dry	
	9-Feb-2016				Dry	
	5-Nov-2015				Dry	
	5-Aug-2015				Dry	
	6-May-2015				Dry	
	6-Feb-2015				Dry	
	5-Nov-2014				Dry	
	13-Aug-2014				Dry	
	12-May-2014				Dry	
	12-Feb-2014				Dry	
	7-Nov-2013				51.65	3814.37
	6-Aug-2013				51.11	3814.91
	7-May-2013				51.50	3814.52
	7-Feb-2013				50.43	3815.59
	25-Oct-2012				50.81	3815.21
	30-Jul-2012				51.09	3814.93
	24-Apr-2012				Dry	
	24-Jan-2012				49.40	3816.62
	7-Dec-2011				49.85	3816.17
	19-Jul-2011				49.31	3816.71
	19-Apr-2011				48.92	3817.10
	17-Jan-2011				48.18	3817.84
	15-Sep-2010				47.64	3818.38
	23-Jun-2010				48.79	3817.23
	22-Mar-2010				49.12	3816.90
8-Dec-2009	47.60	3818.42				
28-Aug-2009	47.53	3818.49				
26-May-2009	48.03	3817.99				
10-Dec-2008	48.72	3817.30				
27-Sep-2008	47.52	3818.50				
10-Jun-2008	49.31	3816.71				
6-Feb-2008	48.00	3818.02				
13-Nov-2007	48.88	3817.14				
13-Sep-2007	48.84	3817.18				

**TABLE 1. SUMMARY OF MONITORING WELL FLUID GAUGING DATA
DONA ANA DAIRIES, DONA ANA COUNTY, NEW MEXICO**

Monitoring Well	Date Measured	Northing ^a	Easting ^a	Casing Elevation ^b	Depth to Water ^c	Ground Water Elevation ^b
177-07R	11-May-2020	415240.93	1515476.47	3858.91	47.26	3811.65
	5-Feb-2020				46.62	3812.29
	8-Nov-2019				46.39	3812.52
	1-Aug-2019				47.65	3811.26
	8-May-2019				47.23	3811.68
	19-Feb-2019				46.60	3812.31
	12-Nov-2018				46.70	3812.21
	6-Aug-2018				47.09	3811.82
	17-May-2018				47.00	3811.91
	5-Feb-2018				46.16	3812.75
	6-Nov-2017				46.62	3812.29
	8-Aug-2017				47.30	3811.61
	15-May-2017				47.68	3811.23
	7-Feb-2017				47.06	3811.85
	7-Nov-2016				47.50	3811.41
	15-Aug-2016				48.12	3810.79
	16-May-2016				48.09	3810.82
	9-Feb-2016				47.42	3811.49
	5-Nov-2015				47.57	3811.34
	5-Aug-2015				47.67	3811.24
	6-May-2015				47.35	3811.56
	6-Feb-2015				46.70	3812.21
	10-Nov-2014				46.53	3812.38
	13-Aug-2014				45.50	3813.41
	13-May-2014				46.66	3812.25
	12-Feb-2014				45.90	3813.01
	7-Nov-2013				45.50	3813.41
	6-Aug-2013				45.51	3813.40
	7-May-2013				45.22	3813.69
	7-Feb-2013				44.44	3814.47
	25-Oct-2012				43.98	3814.93
30-Jul-2012	43.60	3815.31				
24-Apr-2012	43.56	3815.35				
24-Jan-2012	43.08	3815.83				
7-Dec-2011	43.46	3815.45				
19-Jul-2011	42.91	3816.00				
19-Apr-2011	41.96	3816.95				
177-07	5-Nov-2014	415258.95	1515471.64	3859.96	Plugged and Abandoned	
	17-Jan-2011				Dry	
	15-Sep-2010				Dry	
	23-Jun-2010				Dry	
	22-Mar-2010				Dry	
	8-Dec-2009				Dry	
	10-Dec-2008				Dry	
	27-Sep-2008				Dry	
	10-Jun-2008				Dry	
	6-Feb-2008				Dry	
	13-Nov-2007				Dry	
13-Sep-2007	Dry					

**TABLE 1. SUMMARY OF MONITORING WELL FLUID GAUGING DATA
DONA ANA DAIRIES, DONA ANA COUNTY, NEW MEXICO**

Monitoring Well	Date Measured	Northing ^a	Easting ^a	Casing Elevation ^b	Depth to Water ^c	Ground Water Elevation ^b
CENTRAL AREA						
Buena Vista Dairy II						
74-01	3-Nov-2023	405434.93	1519310.15	3841.01	38.51	3802.50
	4-Aug-2023				39.03	3801.98
	3-May-2023				39.12	3801.89
	6-Feb-2023				38.26	3802.75
	3-Nov-2022				38.40	3802.61
	4-Aug-2022				38.06	3802.95
	3-May-2022				37.51	3803.50
	9-Feb-2022				36.65	3804.36
	3-Nov-2021				37.60	3803.41
	6-Aug-2021				37.70	3803.31
	5-May-2021				36.69	3804.32
	11-Feb-2021				35.79	3805.22
	3-Nov-2020				36.49	3804.52
	11-Aug-2020				36.47	3804.54
	12-May-2020				36.35	3804.66
	5-Feb-2020				35.94	3805.07
	8-Nov-2019				36.71	3804.30
	1-Aug-2019				37.18	3803.83
	9-May-2019				37.05	3803.96
	20-Feb-2019				35.75	3805.26
	13-Nov-2018				36.24	3804.77
	7-Aug-2018				36.32	3804.69
	17-May-2018				36.35	3804.66
	6-Feb-2018				35.04	3805.97
	6-Nov-2017				35.65	3805.36
	7-Aug-2017				36.51	3804.50
	16-May-2017				37.00	3804.01
	7-Feb-2017				35.73	3805.28
	8-Nov-2016				36.17	3804.84
	16-Aug-2016				37.04	3803.97
	17-May-2016				37.32	3803.69
	9-Feb-2016				36.00	3805.01
	5-Nov-2015				36.63	3804.38
	6-Aug-2015				37.05	3803.96
	6-May-2015				37.38	3803.63
	5-Feb-2015				35.45	3805.56
	5-Nov-2014				36.66	3804.35
	13-Aug-2014				36.71	3804.30
	18-Jun-2014				37.09	3803.92
	12-Feb-2014				35.17	3805.84
	6-Nov-2013				35.77	3805.24
	6-Aug-2013				36.56	3804.45
	7-May-2013				35.02	3805.99
	7-Feb-2013				33.64	3807.37
	25-Oct-2012				34.94	3806.07
	31-Jul-2012				34.53	3806.48
	24-Apr-2012				34.27	3806.74
	24-Jan-2012				33.36	3807.65
	8-Dec-2011				33.63	3807.38
	19-Jul-2011				33.31	3807.70
	20-Apr-2011				31.97	3809.04
	21-Jan-2011				32.23	3808.78
	16-Sep-2010				31.97	3809.04
	23-Jun-2010				32.08	3808.93
	22-Mar-2010				32.07	3808.94
	8-Dec-2009				31.45	3809.56
	28-Aug-2009				32.20	3808.81
	26-May-2009				32.20	3808.81
	10-Dec-2008				31.31	3809.70
	27-Sep-2008				31.64	3809.37
	10-Jun-2008				32.00	3809.01
	5-Feb-2008				31.66	3809.35
	14-Nov-2007				31.21	3809.80
	12-Sep-2007				31.63	3809.38

**TABLE 1. SUMMARY OF MONITORING WELL FLUID GAUGING DATA
DONA ANA DAIRIES, DONA ANA COUNTY, NEW MEXICO**

Monitoring Well	Date Measured	Northing ^a	Easting ^a	Casing Elevation ^b	Depth to Water ^c	Ground Water Elevation ^b
74-02	3-Nov-2023	404574.08	1519035.52	3820.58	18.80	3801.78
	4-Aug-2023				19.17	3801.41
	3-May-2023				18.78	3801.80
	6-Feb-2023				18.38	3802.20
	3-Nov-2022				18.86	3801.72
	4-Aug-2022				18.74	3801.84
	7-May-2022				18.11	3802.47
	8-Feb-2022				17.23	3803.35
	3-Nov-2021				18.03	3802.55
	6-Aug-2021				18.20	3802.38
	5-May-2021				16.85	3803.73
	11-Feb-2021				15.99	3804.59
	3-Nov-2020				16.70	3803.88
	11-Aug-2020				17.28	3803.30
	12-May-2020				17.68	3802.90
	5-Feb-2020				16.10	3804.48
	8-Nov-2019				16.98	3803.60
	1-Aug-2019				17.57	3803.01
	9-May-2019				17.55	3803.03
	20-Feb-2019				16.00	3804.58
	13-Nov-2018				16.50	3804.08
	7-Aug-2018				16.61	3803.97
	17-May-2018				16.77	3803.81
	6-Feb-2018				15.16	3805.42
	6-Nov-2017				15.76	3804.82
	7-Aug-2017				16.87	3803.71
	16-May-2017				17.61	3802.97
	7-Feb-2017				16.01	3804.57
	8-Nov-2016				16.46	3804.12
	16-Aug-2016				17.59	3802.99
	17-May-2016				18.13	3802.45
	9-Feb-2016				16.40	3804.18
	5-Nov-2015				17.16	3803.42
	6-Aug-2015				17.89	3802.69
	6-May-2015				18.11	3802.47
	5-Feb-2015				16.00	3804.58
	5-Nov-2014				17.16	3803.42
	13-Aug-2014				17.50	3803.08
	18-Jun-2014				18.13	3802.45
	12-Feb-2014				15.75	3804.83
	6-Nov-2013				17.07	3803.51
	6-Aug-2013				17.55	3803.03
	7-May-2013				16.22	3804.36
	7-Feb-2013				15.84	3804.74
	25-Oct-2012				16.02	3804.56
	31-Jul-2012				15.09	3805.49
	24-Apr-2012				14.30	3806.28
	24-Jan-2012				13.96	3806.62
	8-Dec-2011				15.49	3805.09
	19-Jul-2011				14.19	3806.39
	20-Apr-2011				12.45	3808.13
	17-Jan-2011				12.53	3808.05
	16-Sep-2010				12.45	3808.13
	23-Jun-2010				12.87	3807.71
	22-Mar-2010				12.72	3807.86
	8-Dec-2009				11.88	3808.70
	28-Aug-2009				12.53	3808.05
	26-May-2009				12.70	3807.88
	10-Dec-2008				11.65	3808.93
	27-Sep-2008				12.03	3808.55
	10-Jun-2008				12.39	3808.19
	5-Feb-2008				11.94	3808.64
	14-Nov-2007				11.52	3809.06
	12-Sep-2007				12.33	3808.25

**TABLE 1. SUMMARY OF MONITORING WELL FLUID GAUGING DATA
DONA ANA DAIRIES, DONA ANA COUNTY, NEW MEXICO**

Monitoring Well	Date Measured	Northing ^a	Easting ^a	Casing Elevation ^b	Depth to Water ^c	Ground Water Elevation ^b
74-03	3-Nov-2023	407163.61	1516711.72	3823.36	18.08	3805.28
	4-Aug-2023				18.60	3804.76
	3-May-2023				19.10	3804.26
	6-Feb-2023				18.41	3804.95
	3-Nov-2022				18.40	3804.96
	4-Aug-2022				18.18	3805.18
	3-May-2022				17.60	3805.76
	8-Feb-2022				16.81	3806.55
	3-Nov-2021				17.25	3806.11
	6-Aug-2021				16.97	3806.39
	5-May-2021				16.20	3807.16
	11-Feb-2021				15.61	3807.75
	3-Nov-2020				15.67	3807.69
	11-Aug-2020				15.97	3807.39
	12-May-2020				16.51	3806.85
	5-Feb-2020				15.68	3807.68
	8-Nov-2019				15.77	3807.59
	1-Aug-2019				16.55	3806.81
	9-May-2019				16.39	3806.97
	20-Feb-2019				15.57	3807.79
	13-Nov-2018				15.68	3807.68
	7-Aug-2018				15.40	3807.96
	17-May-2018				15.50	3807.86
	6-Feb-2018				14.67	3808.69
	6-Nov-2017				14.71	3808.65
	7-Aug-2017				15.56	3807.80
	16-May-2017				16.38	3806.98
	7-Feb-2017				15.53	3807.83
	8-Nov-2016				15.57	3807.79
	16-Aug-2016				16.01	3807.35
	20-May-2016				16.57	3806.79
	9-Feb-2016				16.05	3807.31
	5-Nov-2015				16.10	3807.26
	5-Aug-2015				16.16	3807.20
	6-May-2015				16.29	3807.07
	5-Feb-2015				15.75	3807.61
	5-Nov-2014				15.67	3807.69
	13-Aug-2014				16.07	3807.29
	18-Jun-2014				16.73	3806.63
	12-Feb-2014				15.63	3807.73
	6-Nov-2013				15.53	3807.83
	6-Aug-2013				15.43	3807.93
	7-May-2013				14.85	3808.51
	7-Feb-2013				13.93	3809.43
	25-Oct-2012				14.22	3809.14
	31-Jul-2012				14.17	3809.19
	24-Apr-2012				13.99	3809.37
	24-Jan-2012				13.60	3809.76
	8-Dec-2011				13.70	3809.66
	19-Jul-2011				13.17	3810.19
	20-Apr-2011				12.11	3811.25
	17-Jan-2011				12.63	3810.73
	16-Sep-2010				12.41	3810.95
	23-Jun-2010				12.72	3810.64
	22-Mar-2010				12.94	3810.42
	8-Dec-2009				12.88	3810.48
	28-Aug-2009				12.63	3810.73
	26-May-2009				12.94	3810.42
	10-Dec-2008				13.00	3810.36
	27-Sep-2008				12.94	3810.42
	10-Jun-2008				12.66	3810.7
	5-Feb-2008				12.94	3810.42
	14-Nov-2007				12.77	3810.59
	12-Sep-2007				12.53	3810.83

**TABLE 1. SUMMARY OF MONITORING WELL FLUID GAUGING DATA
DONA ANA DAIRIES, DONA ANA COUNTY, NEW MEXICO**

Monitoring Well	Date Measured	Northing ^a	Easting ^a	Casing Elevation ^b	Depth to Water ^c	Ground Water Elevation ^b
74-04	3-Nov-2023	405488.65	1519864.48	3853.17	50.67	3802.50
	4-Aug-2023				51.07	3802.10
	3-May-2023				51.00	3802.17
	6-Feb-2023				50.20	3802.97
	3-Nov-2022				50.42	3802.75
	4-Aug-2022				50.36	3802.81
	3-May-2022				49.72	3803.45
	9-Feb-2022				48.85	3804.32
	3-Nov-2021				49.70	3803.47
	6-Aug-2021				49.62	3803.55
	5-May-2021				48.95	3804.22
	11-Feb-2021				48.09	3805.08
	3-Nov-2020				48.71	3804.46
	11-Aug-2020				48.93	3804.24
	12-May-2020				49.21	3803.96
	5-Feb-2020				48.21	3804.96
	8-Nov-2019				48.95	3804.22
	1-Aug-2019				49.30	3803.87
	9-May-2019				49.00	3804.17
	20-Feb-2019				47.95	3805.22
	13-Nov-2018				48.45	3804.72
	7-Aug-2018				48.48	3804.69
	17-May-2018				48.37	3804.80
	6-Feb-2017				47.35	3805.82
	6-Nov-2017				47.95	3805.22
	7-Aug-2017				48.78	3804.39
	16-May-2017				49.00	3804.17
	7-Feb-2017				47.97	3805.20
	8-Nov-2016				48.44	3804.73
	16-Aug-2016				49.27	3803.90
	17-May-2016				NM	NM
	9-Feb-2016				48.35	3804.82
	5-Nov-2015				49.03	3804.14
	6-Aug-2015				49.21	3803.96
	6-May-2015				49.44	3803.73
	5-Feb-2015				47.86	3805.31
	5-Nov-2014				49.58	3803.59
	13-Aug-2014				49.12	3804.05
	18-Jun-2014				49.35	3803.82
	12-Feb-2014				47.75	3805.42
	6-Nov-2013				48.06	3805.11
	6-Aug-2013				48.55	3804.62
	7-May-2013				47.45	3805.72
	7-Feb-2013				46.31	3806.86
	25-Oct-2012				46.96	3806.21
	31-Jul-2012				47.16	3806.01
	24-Apr-2012				47.05	3806.12
	24-Jan-2012				45.78	3807.39
	8-Dec-2011				45.98	3807.19
	19-Jul-2011				45.61	3807.56
	20-Apr-2011				44.19	3808.98
	17-Jan-2011				44.02	3809.15
	16-Sep-2010				44.19	3808.98
	23-Jun-2010				44.26	3808.91
	22-Mar-2010				44.25	3808.92
	8-Dec-2009				43.86	3809.31
	28-Aug-2009				44.49	3808.68
	26-May-2009				44.56	3808.61
	10-Dec-2008				43.70	3809.47
	27-Sep-2008				43.99	3809.18
	10-Jun-2008				44.40	3808.77
	5-Feb-2008				43.41	3809.76

**TABLE 1. SUMMARY OF MONITORING WELL FLUID GAUGING DATA
DONA ANA DAIRIES, DONA ANA COUNTY, NEW MEXICO**

Monitoring Well	Date Measured	Northing ^a	Easting ^a	Casing Elevation ^b	Depth to Water ^c	Ground Water Elevation ^b
74-05	3-Nov-2023	404747.71	1519885.3	3845.35	43.38	3801.97
	4-Aug-2023				43.88	3801.47
	3-May-2023				43.23	3802.12
	6-Feb-2023				42.80	3802.55
	3-Nov-2022				43.25	3802.10
	4-Aug-2022				43.00	3802.35
	3-May-2022				42.39	3802.96
	9-Feb-2022				41.68	3803.67
	3-Nov-2021				42.40	3802.95
	6-Aug-2021				42.50	3802.85
	5-May-2021				41.60	3803.75
	11-Feb-2021				40.73	3804.62
	3-Nov-2020				41.40	3803.95
	11-Aug-2020				40.92	3804.43
	12-May-2020				41.83	3803.52
	5-Feb-2020				40.90	3804.45
	8-Nov-2019				41.68	3803.67
	1-Aug-2019				42.12	3803.23
	9-May-2019				41.87	3803.48
	20-Feb-2019				40.65	3804.70
	13-Nov-2018				41.18	3804.17
	7-Aug-2018				41.22	3804.13
	17-May-2018				41.19	3804.16
	6-Feb-2018				39.97	3805.38
	6-Nov-2017				40.59	3804.76
	7-Aug-2017				41.59	3803.76
	16-May-2017				41.93	3803.42
	7-Feb-2017				40.74	3804.61
	8-Nov-2016				41.23	3804.12
	16-Aug-2016				42.23	3803.12
	17-May-2016				42.62	3802.73
	9-Feb-2016				41.19	3804.16
	5-Nov-2015				42.00	3803.35
	6-Aug-2015				42.35	3803.00
	6-May-2015				41.63	3803.72
	5-Feb-2015				40.78	3804.57
	5-Nov-2014				41.99	3803.36
	13-Aug-2014				42.28	3803.07
	18-Jun-2014				42.73	3802.62
	12-Feb-2014				40.76	3804.59
	6-Nov-2013				41.17	3804.18
	6-Aug-2013				41.80	3803.55
	7-May-2013				40.98	3804.37
	7-Feb-2013				39.40	3805.95
	25-Oct-2012				40.33	3805.02
	31-Jul-2012				40.19	3805.16
	24-Apr-2012				40.05	3805.30
	24-Jan-2012				38.78	3806.57
	8-Dec-2011				39.18	3806.17
	19-Jul-2011				38.84	3806.51
	20-Apr-2011				37.99	3807.36
	17-Jan-2011				36.96	3808.39
	16-Sep-2010				37.00	3808.35
	23-Jun-2010				37.44	3807.91
	22-Mar-2010				37.23	3808.12
	8-Dec-2009				36.74	3808.61
	28-Aug-2009				37.32	3808.03
	26-May-2009				37.47	3807.88
	10-Dec-2008				36.53	3808.82
	27-Sep-2008				36.88	3808.47
	10-Jun-2008				37.39	3807.96
	5-Feb-2008				36.77	3808.58

**TABLE 1. SUMMARY OF MONITORING WELL FLUID GAUGING DATA
DONA ANA DAIRIES, DONA ANA COUNTY, NEW MEXICO**

Monitoring Well	Date Measured	Northing ^a	Easting ^a	Casing Elevation ^b	Depth to Water ^c	Ground Water Elevation ^b
River Valley Dairy						
167-01	6-Feb-2018	402518.37	1518459.71	3818.94	14.31	3804.63
	7-Nov-2017				14.48	3804.46
	7-Aug-2017				15.27	3803.67
	16-May-2017				17.65	3801.29
	7-Feb-2017				15.31	3803.63
	8-Nov-2016				15.63	3803.31
	30-Aug-2016				15.90	3803.04
	20-May-2016				18.97	3799.97
	10-Feb-2016				16.37	3802.57
	5-Nov-2015				17.30	3801.64
	6-Aug-2015				17.91	3801.03
	6-May-2015				18.04	3800.90
	5-Feb-2015				16.18	3802.76
	10-Nov-2014				17.86	3801.08
	13-Aug-2014				18.49	3800.45
	18-Jun-2014				19.77	3799.17
	12-Feb-2014				16.81	3802.13
	6-Nov-2013				18.82	3800.12
	6-Aug-2013				19.11	3799.83
	7-May-2013				18.43	3800.51
	7-Feb-2013				17.02	3801.92
	25-Oct-2012				17.23	3801.71
	31-Jul-2012				16.91	3802.03
	24-Apr-2012				16.01	3802.93
	24-Jan-2012				14.60	3804.34
	8-Dec-2011				15.06	3803.88
	19-Jul-2011				16.81	3802.13
	25-Apr-2011				14.51	3804.43
	17-Jan-2011				12.33	3806.61
	15-Sep-2010				12.19	3806.75
	25-Jun-2010				13.31	3805.63
	22-Mar-2010				13.46	3805.48
	8-Dec-2009				12.11	3806.83
	28-Aug-2009				11.99	3806.95
	26-May-2009				12.43	3806.51
	10-Dec-2008				12.13	3806.81
	27-Sep-2008				12.09	3806.85
	10-Jun-2008				12.95	3805.99
	5-Feb-2008				12.62	3806.32
	14-Nov-2007				12.68	3806.26

**TABLE 1. SUMMARY OF MONITORING WELL FLUID GAUGING DATA
DONA ANA DAIRIES, DONA ANA COUNTY, NEW MEXICO**

Monitoring Well	Date Measured	Northing ^a	Easting ^a	Casing Elevation ^b	Depth to Water ^c	Ground Water Elevation ^b
167-01A	6-Feb-2018	402518.18	1518936.72	3818.88	14.50	3804.38
	7-Nov-2017				14.82	3804.06
	7-Aug-2017				15.79	3803.09
	16-May-2017				17.62	3801.26
	7-Feb-2017				15.45	3803.43
	8-Nov-2016				15.89	3802.99
	30-Aug-2016				16.41	3802.47
	16-May-2016				18.81	3800.07
	10-Feb-2016				16.50	3802.38
	5-Nov-2015				17.51	3801.37
	6-Aug-2015				18.10	3800.78
	6-May-2015				18.84	3800.04
	5-Feb-2015				16.32	3802.56
	5-Nov-2014				17.35	3801.53
	13-Aug-2014				18.34	3800.54
	18-Jun-2014				19.65	3799.23
	12-Feb-2014				16.79	3802.09
	6-Nov-2013				18.19	3800.69
	6-Aug-2013				18.54	3800.34
	7-May-2013				18.22	3800.66
	7-Feb-2013				17.45	3801.43
	25-Oct-2012				17.38	3801.50
	31-Jul-2012				17.08	3801.80
	24-Apr-2012				16.29	3802.59
	24-Jan-2012				14.59	3804.29
	13-Dec-2011				15.13	3803.75
	19-Jul-2011				16.04	3802.84
	25-Apr-2011				14.13	3804.75
	17-Jan-2011				12.38	3806.50
	15-Sep-2010				12.21	3806.67
	22-Jun-2010				13.74	3805.14
	22-Mar-2010				13.22	3805.66
8-Dec-2009	12.17	3806.71				
28-Aug-2009	12.23	3806.65				
26-May-2009	12.62	3806.26				
10-Dec-2008	12.03	3806.85				
27-Sep-2008	12.18	3806.70				
10-Jun-2008	13.16	3805.72				

**TABLE 1. SUMMARY OF MONITORING WELL FLUID GAUGING DATA
DONA ANA DAIRIES, DONA ANA COUNTY, NEW MEXICO**

Monitoring Well	Date Measured	Northing ^a	Easting ^a	Casing Elevation ^b	Depth to Water ^c	Ground Water Elevation ^b
167-02	6-Feb-2018	402498.3	1519354.81	3819.64	15.80	3803.84
	7-Nov-2017				16.18	3803.46
	7-Aug-2017				16.75	3802.89
	16-May-2017				18.97	3800.67
	7-Feb-2017				16.90	3802.74
	8-Nov-2016				17.22	3802.42
	30-Aug-2016				17.38	3802.26
	16-May-2016				20.44	3799.20
	10-Feb-2016				17.88	3801.76
	5-Nov-2015				18.70	3800.94
	6-Aug-2015				18.98	3800.66
	12-May-2015				20.88	3798.76
	6-May-2015				21.50	3798.14
	5-Feb-2015				17.25	3802.39
	10-Nov-2014				Dry	
	13-Aug-2014				19.35	3800.29
	18-Jun-2014				Dry	
	12-Feb-2014				17.94	3801.70
	6-Nov-2013				Dry	
	6-Aug-2013				Dry	
	7-May-2013				Dry	
	7-Feb-2013				Dry	
	25-Oct-2012				Dry	
	31-Jul-2012				Dry	
	24-Apr-2012				Dry	
	24-Jan-2012				15.84	3803.80
	8-Dec-2011				15.92	3803.72
	19-Jul-2011				Dry	
	25-Apr-2011				13.48	3806.16
	17-Jan-2011				13.49	3806.15
	15-Sep-2010				13.68	3805.96
	22-Jun-2010				15.23	3804.41
	22-Mar-2010				14.69	3804.95
	8-Dec-2009				13.32	3806.32
	28-Aug-2009				13.65	3805.99
	26-May-2009				13.86	3805.78
	10-Dec-2008				13.43	3806.21
	27-Sep-2008				13.71	3805.93
	10-Jun-2008				14.70	3804.94
	5-Feb-2008				13.54	3806.10
14-Nov-2007	13.65	3805.99				
11-Sep-2007	13.98	3805.66				

**TABLE 1. SUMMARY OF MONITORING WELL FLUID GAUGING DATA
DONA ANA DAIRIES, DONA ANA COUNTY, NEW MEXICO**

Monitoring Well	Date Measured	Northing ^a	Easting ^a	Casing Elevation ^b	Depth to Water ^c	Ground Water Elevation ^b
167-03	6-Feb-2018	402981.73	1519415.73	3825.66	21.15	3804.51
	7-Nov-2017				21.68	3803.98
	7-Aug-2017				22.76	3802.90
	16-May-2017				24.00	3801.66
	7-Feb-2017				22.09	3803.57
	8-Nov-2016				22.55	3803.11
	30-Aug-2016				23.22	3802.44
	16-May-2016				25.07	3800.59
	10-Feb-2016				22.98	3802.68
	5-Nov-2015				23.96	3801.70
	6-Aug-2015				24.52	3801.14
	6-May-2015				24.58	3801.08
	5-Feb-2015				22.70	3802.96
	10-Nov-2014				24.45	3801.21
	13-Aug-2014				24.81	3800.85
	18-Jun-2014				25.84	3799.82
	12-Feb-2014				23.04	3802.62
	6-Nov-2013				24.79	3800.87
	6-Aug-2013				25.27	3800.39
	7-May-2013				22.99	3802.67
	7-Feb-2013				22.06	3803.60
	25-Oct-2012				23.49	3802.17
	31-Jul-2012				22.63	3803.03
	24-Apr-2012				21.97	3803.69
	24-Jan-2012				20.94	3804.72
	8-Dec-2011				21.73	3803.93
	19-Jul-2011				23.22	3802.44
	25-Apr-2011				18.78	3806.88
	17-Jan-2011				18.86	3806.80
	15-Sep-2010				18.81	3806.85
	22-Jun-2010				19.90	3805.76
	22-Mar-2010				19.71	3805.95
	8-Dec-2009				18.62	3807.04
	28-Aug-2009				18.90	3806.76
	27-May-2009				19.26	3806.40
	10-Dec-2008				18.41	3807.25
	27-Sep-2008				18.72	3806.94
	10-Jun-2008				19.82	3805.84
	5-Feb-2008				18.64	3807.02
	14-Nov-2007				18.55	3807.11
	11-Sep-2007				19.02	3806.64

**TABLE 1. SUMMARY OF MONITORING WELL FLUID GAUGING DATA
DONA ANA DAIRIES, DONA ANA COUNTY, NEW MEXICO**

Monitoring Well	Date Measured	Northing ^a	Easting ^a	Casing Elevation ^b	Depth to Water ^c	Ground Water Elevation ^b
167-04	6-Feb-2018	402032.19	1519884.6	3827.60	23.45	3804.15
	7-Nov-2017				23.84	3803.76
	7-Aug-2017				24.68	3802.92
	16-May-2017				26.21	3801.39
	7-Feb-2017				24.34	3803.26
	8-Nov-2016				24.87	3802.73
	30-Aug-2016				25.30	3802.30
	16-May-2016				27.10	3800.50
	10-Feb-2016				25.37	3802.23
	5-Nov-2015				26.23	3801.37
	6-Aug-2015				26.73	3800.87
	6-May-2015				27.07	3800.53
	5-Feb-2015				25.22	3802.38
	10-Nov-2014				26.18	3801.42
	13-Aug-2014				26.91	3800.69
	18-Jun-2014				27.94	3799.66
	12-Feb-2014				25.42	3802.18
	6-Nov-2013				26.38	3801.22
	6-Aug-2013				26.70	3800.90
	7-May-2013				25.59	3802.01
	7-Feb-2013				24.84	3802.76
	25-Oct-2012				25.60	3802.00
	31-Jul-2012				25.19	3802.41
	24-Apr-2012				25.05	3802.55
	24-Jan-2012				23.36	3804.24
	8-Dec-2011				24.01	3803.59
	19-Jul-2011				24.36	3803.24
	25-Apr-2011				21.23	3806.37
	17-Jan-2011				21.18	3806.42
	15-Sep-2010				Well Damaged	
	22-Jun-2010					
	22-Mar-2010				Well Damaged	
	8-Dec-2009					
28-Aug-2009	21.57	3806.03				
26-May-2009	21.60	3806.00				
10-Dec-2008	21.01	3806.59				
27-Sep-2008	21.01	3806.59				
10-Jun-2008	22.20	3805.40				
5-Feb-2008	21.51	3806.09				
14-Nov-2007	21.44	3806.16				
11-Sep-2007	21.68	3805.92				

**TABLE 1. SUMMARY OF MONITORING WELL FLUID GAUGING DATA
DONA ANA DAIRIES, DONA ANA COUNTY, NEW MEXICO**

Monitoring Well	Date Measured	Northing ^a	Easting ^a	Casing Elevation ^b	Depth to Water ^c	Ground Water Elevation ^b
167-05	6-Feb-2018	397947.44	1520446.03	3815.44	14.61	3800.83
	7-Nov-2017				14.59	3800.85
	7-Aug-2017				14.94	3800.50
	16-May-2017				16.91	3798.53
	7-Feb-2017				15.40	3800.04
	8-Nov-2016				15.97	3799.47
	30-Aug-2016				15.43	3800.01
	16-May-2016				17.69	3797.75
	10-Feb-2016				16.42	3799.02
	5-Nov-2015				16.96	3798.48
	6-Aug-2015				16.12	3799.32
	6-May-2015				17.98	3797.46
	5-Feb-2015				16.13	3799.31
	10-Nov-2014				16.84	3798.60
	13-Aug-2014				15.94	3799.50
	18-Jun-2014				17.19	3798.25
	12-Feb-2014				15.73	3799.71
	6-Nov-2013				15.75	3799.69
	6-Aug-2013				16.03	3799.41
	7-May-2013				15.42	3800.02
	7-Feb-2013				14.96	3800.48
	25-Oct-2012				15.74	3799.70
	31-Jul-2012				15.60	3799.84
	24-Apr-2012				14.99	3800.45
	30-Jan-2012				13.86	3801.58
	13-Dec-2011				14.10	3801.34
	19-Jul-2011				13.69	3801.75
	19-Apr-2011				12.97	3802.47
	17-Jan-2011				11.90	3803.54
	15-Sep-2010				11.52	3803.92
	25-Jun-2010				12.43	3803.01
	22-Mar-2010				12.22	3803.22
8-Dec-2009	11.96	3803.48				
28-Aug-2009	11.63	3803.81				
26-May-2009	11.45	3803.99				
10-Dec-2008	11.54	3803.90				
27-Sep-2008	11.20	3804.24				
10-Jun-2008	12.65	3802.79				
5-Feb-2008	12.36	3803.08				
14-Nov-2007	12.77	3802.67				
11-Sep-2007	12.91	3802.53				

**TABLE 1. SUMMARY OF MONITORING WELL FLUID GAUGING DATA
DONA ANA DAIRIES, DONA ANA COUNTY, NEW MEXICO**

Monitoring Well	Date Measured	Northing ^a	Easting ^a	Casing Elevation ^b	Depth to Water ^c	Ground Water Elevation ^b
167-06	6-Feb-2018	404479.35	1519603.88	3834.84	29.52	3805.32
	7-Nov-2017				30.11	3804.73
	7-Aug-2017				31.20	3803.64
	16-May-2017				31.71	3803.13
	7-Feb-2017				30.35	3804.49
	8-Nov-2016				30.83	3804.01
	30-Aug-2016				31.55	3803.29
	16-May-2016				32.40	3802.44
	10-Feb-2016				30.83	3804.01
	5-Nov-2015				31.73	3803.11
	6-Aug-2015				32.13	3802.71
	6-May-2015				32.36	3802.48
	5-Feb-2015				30.44	3804.40
	10-Nov-2014				31.33	3803.51
	13-Aug-2014				32.08	3802.76
	18-Jun-2014				32.63	3802.21
	12-Feb-2014				30.42	3804.42
	6-Nov-2013				30.95	3803.89
	6-Aug-2013				31.73	3803.11
	7-May-2013				30.83	3804.01
	7-Feb-2013				30.00	3804.84
	25-Oct-2012				30.12	3804.72
	31-Jul-2012				30.29	3804.55
	24-Apr-2012				29.84	3805.00
	24-Jan-2012				28.48	3806.36
	8-Dec-2011				29.10	3805.74
	19-Jul-2011				28.75	3806.09
	25-Apr-2011				26.71	3808.13
	17-Jan-2011				26.73	3808.11
	15-Sep-2010				26.70	3808.14
	22-Jun-2010				27.17	3807.67
	22-Mar-2010				27.02	3807.82
	8-Dec-2009				26.40	3808.44
	28-Aug-2009				26.96	3807.88
	26-May-2009				27.15	3807.69
	10-Dec-2008				26.18	3808.66
	27-Sep-2008				26.54	3808.30
	10-Jun-2008				27.10	3807.74
	5-Feb-2008				26.46	3808.38
	14-Nov-2007				26.60	3808.24
	11-Sep-2007				26.74	3808.10

**TABLE 1. SUMMARY OF MONITORING WELL FLUID GAUGING DATA
DONA ANA DAIRIES, DONA ANA COUNTY, NEW MEXICO**

Monitoring Well	Date Measured	Northing ^a	Easting ^a	Casing Elevation ^b	Depth to Water ^c	Ground Water Elevation ^b
167-07	6-Feb-2018	402562.23	1518480.34	3819.08	14.23	3804.85
	7-Nov-2017				14.47	3804.61
	7-Aug-2017				15.41	3803.67
	16-May-2017				17.45	3801.63
	7-Feb-2017				15.18	3803.90
	8-Nov-2016				15.51	3803.57
	16-May-2016				16.20	3802.88
	16-May-2016				18.79	3800.29
	10-Feb-2016				16.25	3802.83
	5-Nov-2015				17.40	3801.68
	6-Aug-2015				18.28	3800.80
	6-May-2015				18.80	3800.28
	5-Feb-2015				16.26	3802.82
	10-Nov-2014				17.11	3801.97
	13-Aug-2014				18.47	3800.61
	18-Jun-2014				19.76	3799.32
	12-Feb-2014				16.88	3802.20
	6-Nov-2013				17.82	3801.26
	6-Aug-2013				18.25	3800.83
	7-May-2013				16.14	3802.94
	7-Feb-2013				15.84	3803.24
	25-Oct-2012				16.30	3802.78
	31-Jul-2012				16.09	3802.99
	24-Apr-2012				15.84	3803.24
	24-Jan-2012				14.54	3804.54
	8-Dec-2011				15.45	3803.63
	25-Jul-2011				15.39	3803.69
	25-Apr-2011				14.95	3804.13
	17-Jan-2011				12.39	3806.69
	15-Sep-2010				11.98	3807.10
	22-Jun-2010				12.94	3806.14
	22-Mar-2010				13.03	3806.05
8-Dec-2009	12.18	3806.90				
28-Aug-2009	12.06	3807.02				
26-May-2009	12.56	3806.52				
10-Dec-2008	12.24	3806.84				
27-Sep-2008	12.20	3806.88				
10-Jun-2008	13.00	3806.08				

**TABLE 1. SUMMARY OF MONITORING WELL FLUID GAUGING DATA
DONA ANA DAIRIES, DONA ANA COUNTY, NEW MEXICO**

Monitoring Well	Date Measured	Northing ^a	Easting ^a	Casing Elevation ^b	Depth to Water ^c	Ground Water Elevation ^b
167-08	6-Feb-2018	399352.96	1519889.65	3817.96	14.48	3803.48
	7-Nov-2017				14.29	3803.67
	7-Aug-2017				14.42	3803.54
	16-May-2017				17.05	3800.91
	7-Feb-2017				15.22	3802.74
	8-Nov-2016				15.81	3802.15
	16-May-2016				17.68	3800.28
	10-Feb-2016				16.33	3801.63
	23-Nov-2015				16.95	3801.01
	6-Aug-2015				18.40	3799.56
	6-May-2015				19.56	3798.40
	5-Feb-2015				17.78	3800.18
	5-Nov-2014				18.31	3799.65
	13-Aug-2014				18.46	3799.50
	18-Jun-2014				19.71	3798.25
	12-Feb-2014				17.65	3800.31
	6-Nov-2013				17.68	3800.28
	6-Aug-2013				18.07	3799.89
	7-May-2013				16.99	3800.97
	7-Feb-2013				16.73	3801.23
	25-Oct-2012				17.72	3800.24
	31-Jul-2012				17.60	3800.36
	24-Apr-2012				16.71	3801.25
	24-Jan-2012				15.25	3802.71
	8-Dec-2011				15.52	3802.44
	19-Jul-2011				15.59	3802.37
	19-Apr-2011				13.95	3804.01
	17-Jan-2011				13.42	3804.54
	15-Sep-2010				12.92	3805.04
	25-Jun-2010				14.69	3803.27
22-Mar-2010	13.73	3804.23				
8-Dec-2009	13.46	3804.50				
28-Aug-2009	13.23	3804.73				
26-May-2009	12.87	3805.09				
10-Dec-2008	13.42	3804.54				
27-Sep-2008	NM	NM				
10-Jun-2008	14.02	3803.94				

**TABLE 1. SUMMARY OF MONITORING WELL FLUID GAUGING DATA
DONA ANA DAIRIES, DONA ANA COUNTY, NEW MEXICO**

Monitoring Well	Date Measured	Northing ^a	Easting ^a	Casing Elevation ^b	Depth to Water ^c	Ground Water Elevation ^b
167-09	6-Feb-2018	398473.95	1519259.34	3817.00	14.95	3802.05
	7-Nov-2017				14.15	3802.85
	7-Aug-2017				14.96	3802.04
	16-May-2017				17.10	3799.90
	7-Feb-2017				15.70	3801.30
	8-Nov-2016				15.86	3801.14
	30-Aug-2016				15.33	3801.67
	16-May-2016				17.64	3799.36
	10-Feb-2016				16.66	3800.34
	5-Nov-2015				17.28	3799.72
	6-Aug-2015				16.30	3800.70
	6-May-2015				17.96	3799.04
	5-Feb-2015				16.81	3800.19
	5-Nov-2014				16.78	3800.22
	13-Aug-2014				16.92	3800.08
	18-Jun-2014				17.69	3799.31
	12-Feb-2014				16.38	3800.62
	6-Nov-2013				15.91	3801.09
	6-Aug-2013				16.22	3800.78
	7-May-2013				16.09	3800.91
	7-Feb-2013				15.36	3801.64
	25-Oct-2012				15.31	3801.69
	31-Jul-2012				15.04	3801.96
	24-Apr-2012				15.12	3801.88
	24-Jan-2012				14.60	3802.40
	8-Dec-2011				14.42	3802.58
	19-Jul-2011				13.17	3803.83
	19-Apr-2011				12.78	3804.22
	17-Jan-2011				12.70	3804.30
	15-Sep-2010				11.95	3805.05
	25-Jun-2010				13.01	3803.99
	22-Mar-2010				12.88	3804.12
8-Dec-2009	12.82	3804.18				
28-Aug-2009	12.43	3804.57				
26-May-2009	12.44	3804.56				
10-Dec-2008	12.78	3804.22				
27-Sep-2008	12.07	3804.93				
10-Jun-2008	12.94	3804.06				

**TABLE 1. SUMMARY OF MONITORING WELL FLUID GAUGING DATA
DONA ANA DAIRIES, DONA ANA COUNTY, NEW MEXICO**

Monitoring Well	Date Measured	Northing ^a	Easting ^a	Casing Elevation ^b	Depth to Water ^c	Ground Water Elevation ^b
Big Sky Dairy						
833-01	5-Aug-2017	399617.23	1521136.33	3839.55	Plugged and Abandoned	
	16-May-2017				Dry	
	7-Feb-2017				Dry	
	8-Nov-2016				Dry	
	16-Aug-2016				Dry	
	17-May-2016				Dry	
	10-Feb-2016				Dry	
	5-Nov-2015				Dry	
	17-Aug-2015				Dry	
	6-May-2015				Dry	
	6-Feb-2015				Dry	
	5-Nov-2014				Dry	
	12-Aug-2014				Dry	
	18-Jun-2014				Dry	
	12-Feb-2014				Dry	
	6-Nov-2013				Dry	
	6-Aug-2013				Dry	
	8-May-2013				Dry	
	7-Feb-2013				Dry	
	25-Oct-2012				Dry	
	1-Aug-2012				Dry	
	24-Apr-2012				Dry	
	24-Jan-2012				Dry	
	8-Dec-2011				Dry	
	18-Jul-2011				Dry	
	19-Apr-2001				35.44	3804.11
	17-Jan-2011				35.20	3804.35
	14-Sep-2010				34.76	3804.79
	22-Jun-2010				36.08	3803.47
	22-Mar-2010				35.49	3804.06
	8-Dec-2009				35.25	3804.30
	28-Aug-2009				35.25	3804.30
26-May-2009	34.69	3804.86				
10-Dec-2008	34.99	3804.56				
28-Sep-2008	34.58	3804.97				
10-Jun-2008	36.13	3803.42				
5-Feb-2008	35.51	3804.04				
14-Nov-2007	35.70	3803.85				
12-Sep-2007	35.79	3803.76				

**TABLE 1. SUMMARY OF MONITORING WELL FLUID GAUGING DATA
DONA ANA DAIRIES, DONA ANA COUNTY, NEW MEXICO**

Monitoring Well	Date Measured	Northing ^a	Easting ^a	Casing Elevation ^b	Depth to Water ^c	Ground Water Elevation ^b
833-02	3-Nov-2023	401200.32	1520639.92	3836.04	36.70	3799.34
	4-Aug-2023				37.17	3798.87
	3-May-2023				36.40	3799.64
	6-Feb-2023				35.79	3800.25
	4-Nov-2022				36.46	3799.58
	4-Aug-2022				36.39	3799.65
	4-May-2022				35.60	3800.44
	9-Feb-2022				34.64	3801.40
	3-Nov-2021				35.41	3800.63
	6-Aug-2021				35.89	3800.15
	5-May-2021				34.56	3801.48
	12-Feb-2021				33.94	3802.10
	4-Nov-2020				34.15	3801.89
	11-Aug-2020				34.18	3801.86
	12-May-2020				33.99	3802.05
	6-Feb-2020				33.48	3802.56
	8-Nov-2019				33.16	3802.88
	5-Aug-2019				35.51	3800.53
	9-May-2019				35.18	3800.86
	20-Feb-2019				33.90	3802.14
	13-Nov-2018				34.43	3801.61
	7-Aug-2018				34.42	3801.62
	14-May-2018				34.05	3801.99
	6-Feb-2018				33.45	3802.59
	7-Nov-2017				33.19	3802.85
	9-Aug-2017				33.78	3802.26
	16-May-2017				35.28	3800.76
	7-Feb-2017				33.80	3802.24
	8-Nov-2016				34.24	3801.80
	16-Aug-2016				34.85	3801.19
	17-May-2016				35.69	3800.35
	10-Feb-2016				34.79	3801.25
	5-Nov-2015				35.48	3800.56
	6-Aug-2015				35.90	3800.14
	6-May-2015				37.04	3799.00
	6-Feb-2015				35.20	3800.84
	5-Nov-2014				35.48	3800.56
	12-Aug-2014				36.02	3800.02
	18-Jun-2014				36.72	3799.32
	12-Feb-2014				34.61	3801.43
	6-Nov-2013				34.80	3801.24
	6-Aug-2013				35.44	3800.60
	8-May-2013				35.13	3800.91
	7-Feb-2013				33.42	3802.62
	25-Oct-2012				34.61	3801.43
	1-Aug-2012				34.90	3801.14
	24-Apr-2012				33.49	3802.55
	24-Jan-2012				34.01	3802.03
	8-Dec-2011				33.08	3802.96
	18-Jul-2011				32.92	3803.12
	19-Apr-2011				31.92	3804.12
	17-Jan-2011				30.43	3805.61
	14-Sep-2010				30.34	3805.70
	22-Jun-2010				31.37	3804.67
	22-Mar-2010				30.87	3805.17
	8-Dec-2009				30.40	3805.64
	28-Aug-2009				30.58	3805.46
	26-May-2009				30.24	3805.80
	10-Dec-2008				30.13	3805.91
	28-Sep-2008				29.80	3806.24
	10-Jun-2008				31.21	3804.83
	5-Feb-2008				30.63	3805.41
	14-Nov-2007				30.60	3805.44
	12-Sep-2007				30.63	3805.41

**TABLE 1. SUMMARY OF MONITORING WELL FLUID GAUGING DATA
DONA ANA DAIRIES, DONA ANA COUNTY, NEW MEXICO**

Monitoring Well	Date Measured	Northing ^a	Easting ^a	Casing Elevation ^b	Depth to Water ^c	Ground Water Elevation ^b	
833-03	5-Aug-2017	401392.09	1521955.23	3867.06	Plugged and Abandoned		
	16-May-2017				Dry		
	7-Feb-2017				Dry		
	8-Nov-2016				Dry		
	16-Aug-2016				Dry		
	17-May-2016				Dry		
	10-Feb-2016				Dry		
	5-Nov-2015				Dry		
	17-Aug-2015				Dry		
	6-May-2015				Dry		
	6-Feb-2015				Dry		
	5-Nov-2014				Dry		
	12-Aug-2014				Dry		
	18-Jun-2014				Dry		
	12-Feb-2014				Dry		
	6-Nov-2013				Dry		
	6-Aug-2013				Dry		
	8-May-2013				Dry		
	7-Feb-2013				Dry		
	25-Oct-2012				Dry		
	1-Aug-2012				Dry		
	24-Apr-2012				Dry		
	24-Jan-2012				Dry		
	8-Dec-2011				Dry		
	18-Jul-2011				Dry		
	19-Apr-2011					61.92	3805.14
	17-Jan-2011					61.02	3806.04
	14-Sep-2010					60.91	3806.15
	22-Jun-2010					61.90	3805.16
	22-Mar-2010					61.41	3805.65
	8-Dec-2009					61.16	3805.90
	28-Aug-2009					61.50	3805.56
	26-May-2009					61.26	3805.80
10-Dec-2008		60.76	3806.30				
28-Sep-2008		61.59	3805.47				
10-Jun-2008		61.83	3805.23				
5-Feb-2008		61.11	3805.95				
14-Nov-2007		61.08	3805.98				
12-Sep-2007		61.11	3805.95				

**TABLE 1. SUMMARY OF MONITORING WELL FLUID GAUGING DATA
DONA ANA DAIRIES, DONA ANA COUNTY, NEW MEXICO**

Monitoring Well	Date Measured	Northing ^a	Easting ^a	Casing Elevation ^b	Depth to Water ^c	Ground Water Elevation ^b
833-04	3-Nov-2023	402898.52	1520659.33	3845.79	44.90	3800.89
	4-Aug-2023				45.40	3800.39
	3-May-2023				45.05	3800.74
	6-Feb-2023				44.15	3801.64
	4-Nov-2022				44.77	3801.02
	4-Aug-2022				44.66	3801.13
	4-May-2022				43.86	3801.93
	9-Feb-2022				42.95	3802.84
	3-Nov-2021				43.77	3802.02
	6-Aug-2021				44.08	3801.71
	5-May-2021				43.25	3802.54
	12-Feb-2021				42.36	3803.43
	4-Nov-2020				42.89	3802.90
	11-Aug-2020				42.91	3802.88
	12-May-2020				42.28	3803.51
	6-Feb-2020				41.99	3803.80
	8-Nov-2019				41.68	3804.11
	5-Aug-2019				43.88	3801.91
	9-May-2019				43.40	3802.39
	20-Feb-2019				42.36	3803.43
	13-Nov-2018				42.81	3802.98
	7-Aug-2018				42.68	3803.11
	14-May-2018				42.59	3803.20
	6-Feb-2018				41.54	3804.25
	7-Nov-2017				42.17	3803.62
	15-Aug-2017				42.90	3802.89
	16-May-2017				43.63	3802.16
	7-Feb-2017				42.47	3803.32
	8-Nov-2016				42.90	3802.89
	16-Aug-2016				43.91	3801.88
	20-May-2016				44.20	3801.59
	10-Feb-2016				43.15	3802.64
	5-Nov-2015				43.92	3801.87
	6-Aug-2015				44.49	3801.30
	6-May-2015				44.98	3800.81
	6-Feb-2015				43.67	3802.12
	5-Nov-2014				43.98	3801.81
	12-Aug-2014				44.62	3801.17
	18-Jun-2014				45.07	3800.72
	12-Feb-2014				43.19	3802.60
6-Nov-2013	43.59	3802.20				
6-Aug-2013	44.00	3801.79				
8-May-2013	43.63	3802.16				
7-Feb-2013	41.70	3804.09				
25-Oct-2012	41.83	3803.96				
1-Aug-2012	42.70	3803.09				
24-Apr-2012	42.32	3803.47				
24-Jan-2012	40.87	3804.92				
8-Dec-2011	41.55	3804.24				
18-Jul-2011	41.05	3804.74				
19-Apr-2011	39.24	3806.55				
17-Jan-2011	38.80	3806.99				
14-Sep-2010	38.84	3806.95				
22-Jun-2010	39.19	3806.60				
22-Mar-2010	39.13	3806.66				
8-Dec-2009	38.85	3806.94				
28-Aug-2009	39.24	3806.55				
26-May-2009	39.31	3806.48				
10-Dec-2008	38.41	3807.38				
28-Sep-2008	38.42	3807.37				
10-Jun-2008	39.46	3806.33				
5-Feb-2008	38.61	3807.18				
14-Nov-2007	38.54	3807.25				
12-Sep-2007	38.96	3806.83				

**TABLE 1. SUMMARY OF MONITORING WELL FLUID GAUGING DATA
DONA ANA DAIRIES, DONA ANA COUNTY, NEW MEXICO**

Monitoring Well	Date Measured	Northing ^a	Easting ^a	Casing Elevation ^b	Depth to Water ^c	Ground Water Elevation ^b
833-05	3-Nov-2023	399712.39	1522374.73	3865.51	67.53	3797.98
	4-Aug-2023				67.67	3797.84
	3-May-2023				67.57	3797.94
	7-Feb-2023				66.77	3798.74
	4-Nov-2022				67.11	3798.40
	5-Aug-2022				66.78	3798.73
	4-May-2022				66.12	3799.39
	9-Feb-2022				65.17	3800.34
	3-Nov-2021				66.06	3799.45
	6-Aug-2021				66.30	3799.21
	5-May-2021				65.75	3799.76
	12-Feb-2021				64.89	3800.62
	4-Nov-2020				65.24	3800.27
	12-Aug-2020				65.27	3800.24
	12-May-2020				65.91	3799.60
	6-Feb-2020				65.00	3800.51
	7-Nov-2019				65.94	3799.57
	2-Aug-2019				66.10	3799.41
	9-May-2019				65.74	3799.77
	20-Feb-2019				64.85	3800.66
	13-Nov-2018				65.51	3800.00
	7-Aug-2018				65.44	3800.07
	14-May-2018				65.05	3800.46
	6-Feb-2018				64.21	3801.30
	7-Nov-2017				64.45	3801.06
	9-Aug-2017				65.38	3800.13
	16-May-2017				66.10	3799.41
	7-Feb-2017				65.05	3800.46
	8-Nov-2016				65.53	3799.98
	16-Aug-2016				66.06	3799.45
	17-May-2016				66.39	3799.12
	10-Feb-2016				65.94	3799.57
	5-Nov-2015				66.28	3799.23
	6-Aug-2015				66.74	3798.77
	6-May-2015				67.03	3798.48
	6-Feb-2015				65.76	3799.75
	10-Nov-2014				66.10	3799.41
	12-Aug-2014				66.71	3798.80
	18-Jun-2014				66.83	3798.68
	12-Feb-2014				65.32	3800.19
	6-Nov-2013				65.29	3800.22
	6-Aug-2013				65.80	3799.71
	8-May-2013				65.19	3800.32
	7-Feb-2013				64.21	3801.30
	25-Oct-2012				64.60	3800.91
	1-Aug-2012				65.01	3800.50
	24-Apr-2012				64.40	3801.11
	24-Jan-2012				63.60	3801.91
	8-Dec-2011				63.63	3801.88
	18-Jul-2011				63.23	3802.28
	19-Apr-2011				62.33	3803.18
	24-Jan-2011				61.90	3803.61
	14-Sep-2010				61.05	3804.46
	22-Jun-2010				61.97	3803.54
	22-Mar-2010				61.52	3803.99
	8-Dec-2009				61.39	3804.12
	28-Aug-2009				61.52	3803.99
	26-May-2009				61.14	3804.37
	10-Dec-2008				61.07	3804.44
	28-Sep-2008				60.99	3804.52
	10-Jun-2008				62.28	3803.23
	5-Feb-2008				61.52	3803.99

**TABLE 1. SUMMARY OF MONITORING WELL FLUID GAUGING DATA
DONA ANA DAIRIES, DONA ANA COUNTY, NEW MEXICO**

Monitoring Well	Date Measured	Northing ^a	Easting ^a	Casing Elevation ^b	Depth to Water ^c	Ground Water Elevation ^b
833-06	3-Nov-2023	402219.48	1522652.04	3878.20	76.50	3801.70
	4-Aug-2023				77.07	3801.13
	3-May-2023				77.25	3800.95
	6-Feb-2023				76.90	3801.30
	4-Nov-2022				76.61	3801.59
	4-Aug-2022				76.85	3801.35
	4-May-2022				76.38	3801.82
	9-Feb-2022				75.73	3802.47
	3-Nov-2021				76.40	3801.80
	6-Aug-2021				76.35	3801.85
	5-May-2021				76.11	3802.09
	12-Feb-2021				75.73	3802.47
	4-Nov-2020				76.00	3802.20
	12-Aug-2020				75.51	3802.69
	12-May-2020				76.09	3802.11
	6-Feb-2020				76.00	3802.20
	7-Nov-2019				76.51	3801.69
	2-Aug-2019				76.46	3801.74
	9-May-2019				76.00	3802.20
	20-Feb-2019				75.56	3802.64
	13-Nov-2018				75.75	3802.45
	7-Aug-2018				75.39	3802.81
	14-May-2018				75.05	3803.15
	6-Feb-2018				75.20	3803.00
	7-Nov-2017				75.51	3802.69
	9-Aug-2017				76.35	3801.85
	16-May-2017				76.41	3801.79
	7-Feb-2017				75.84	3802.36
	8-Nov-2016				76.13	3802.07
	16-Aug-2016				76.53	3801.67
	17-May-2016				76.58	3801.62
	10-Feb-2016				76.15	3802.05
	5-Nov-2015				76.11	3802.09
	6-Aug-2015				76.49	3801.71
	6-May-2015				76.57	3801.63
	6-Feb-2015				75.79	3802.41
	5-Nov-2014				75.96	3802.24
	12-Aug-2014				76.20	3802.00
	18-Jun-2014				76.18	3802.02
	12-Feb-2014				75.43	3802.77
	6-Nov-2013				75.12	3803.08
	6-Aug-2013				75.47	3802.73
	8-May-2013				74.67	3803.53
	7-Feb-2013				73.80	3804.40
	25-Oct-2012				73.93	3804.27
	1-Aug-2012				74.06	3804.14
	24-Apr-2012				73.97	3804.23
	24-Jan-2012				73.50	3804.70
	8-Dec-2011				73.41	3804.79
	18-Jul-2011				72.93	3805.27
	25-Apr-2001				72.16	3806.04
	17-Jan-2011				71.43	3806.77
	14-Sep-2010				72.05	3806.15
	22-Jun-2010				72.08	3806.12
	22-Mar-2010				72.00	3806.20
	8-Dec-2009				71.92	3806.28
	28-Aug-2009				72.22	3805.98
	26-May-2009				72.02	3806.18
	10-Dec-2008				70.95	3807.25
	28-Sep-2008				70.87	3807.33
	10-Jun-2008				71.78	3806.42
	5-Feb-2008				71.47	3806.73

**TABLE 1. SUMMARY OF MONITORING WELL FLUID GAUGING DATA
DONA ANA DAIRIES, DONA ANA COUNTY, NEW MEXICO**

Monitoring Well	Date Measured	Northing ^a	Easting ^a	Casing Elevation ^b	Depth to Water ^c	Ground Water Elevation ^b
833-07	3-Nov-2023	399298.8	1522082.75	3860.70	63.10	3797.60
	4-Aug-2023				63.24	3797.46
	3-May-2023				63.03	3797.67
	7-Feb-2023				62.29	3798.41
	4-Nov-2022				62.57	3798.13
	5-Aug-2022				62.46	3798.24
	4-May-2022				61.80	3798.90
	9-Feb-2022				60.86	3799.84
	3-Nov-2021				61.72	3798.98
	6-Aug-2021				61.97	3798.73
	5-May-2021				61.30	3799.40
	12-Feb-2021				60.33	3800.37
	4-Nov-2020				60.76	3799.94
	12-Aug-2020				60.92	3799.78
	12-May-2020				61.51	3799.19
	6-Feb-2020				61.06	3799.64
	7-Nov-2019				61.46	3799.24
	2-Aug-2019				61.60	3799.10
	9-May-2019				61.38	3799.32
	20-Feb-2019				60.35	3800.35
	13-Nov-2018				61.06	3799.64
	7-Aug-2018				61.07	3799.63
	14-May-2018				60.75	3799.95
	6-Feb-2018				59.74	3800.96
	7-Nov-2017				60.00	3800.70
	9-Aug-2017				60.87	3799.83
	16-May-2017				61.75	3798.95
	7-Feb-2017				60.56	3800.14
	8-Nov-2016				61.27	3799.43
	16-Aug-2016				61.60	3799.10
	17-May-2016				62.10	3798.60
	10-Feb-2016				61.48	3799.22
	5-Nov-2015				61.95	3798.75
	6-Aug-2015				62.28	3798.42
	6-May-2015				62.87	3797.83
	6-Feb-2015				61.34	3799.36
	10-Nov-2014				61.75	3798.95
	12-Aug-2014				62.28	3798.42
	18-Jun-2014				62.58	3798.12
	12-Feb-2014				60.88	3799.82
	6-Nov-2013				61.12	3799.58
	6-Aug-2013				61.45	3799.25
	8-May-2013				60.76	3799.94
	7-Feb-2013				59.82	3800.88
	25-Oct-2012				60.22	3800.48
	1-Aug-2012				60.63	3800.07
	24-Apr-2012				60.25	3800.45
	24-Jan-2012				59.71	3800.99
	8-Dec-2011				59.26	3801.44
	18-Jul-2011				58.99	3801.71
	19-Apr-2011				57.95	3802.75
	17-Jan-2011				56.87	3803.83
	14-Sep-2010				56.61	3804.09
	22-Jun-2010				57.55	3803.15
	22-Mar-2010				57.05	3803.65
	8-Dec-2009				56.94	3803.76
	28-Aug-2009				57.02	3803.68
	26-May-2009				56.64	3804.06
	10-Dec-2008				56.58	3804.12
	28-Sep-2008				58.53	3802.17
	10-Jun-2008				57.88	3802.82
	5-Feb-2008				57.11	3803.59

**TABLE 1. SUMMARY OF MONITORING WELL FLUID GAUGING DATA
DONA ANA DAIRIES, DONA ANA COUNTY, NEW MEXICO**

Monitoring Well	Date Measured	Northing ^a	Easting ^a	Casing Elevation ^b	Depth to Water ^c	Ground Water Elevation ^b
833-08	3-Nov-2023	400535.64	1521938.23	3861.76	62.74	3799.02
	4-Aug-2023				63.02	3798.74
	3-May-2023				62.92	3798.84
	6-Feb-2023				62.10	3799.66
	4-Nov-2022				62.35	3799.41
	4-Aug-2022				61.95	3799.81
	4-May-2022				61.16	3800.60
	9-Feb-2022				60.24	3801.52
	3-Nov-2021				61.00	3800.76
	6-Aug-2021				61.51	3800.25
	5-May-2021				61.01	3800.75
	12-Feb-2021				60.71	3801.05
	4-Nov-2020				61.01	3800.75
	11-Aug-2020				61.68	3800.08
	12-May-2020				61.12	3800.64
	6-Feb-2020				60.96	3800.80
	7-Nov-2019				61.28	3800.48
	2-Aug-2019				61.46	3800.30
	9-May-2019				60.92	3800.84
	20-Feb-2019				60.10	3801.66
	13-Nov-2018				60.65	3801.11
	7-Aug-2018				60.44	3801.32
	14-May-2018				59.75	3802.01
	6-Feb-2018				59.31	3802.45
	7-Nov-2017				59.51	3802.25
	9-Aug-2017				60.33	3801.43
	16-May-2017				61.03	3800.73
	7-Feb-2017				60.21	3801.55
	8-Nov-2016				60.56	3801.20
	16-Aug-2016				61.21	3800.55
	17-May-2016				61.14	3800.62
	10-Feb-2016				61.11	3800.65
	5-Nov-2015				61.32	3800.44
	6-Aug-2015				61.98	3799.78
	6-May-2015				62.22	3799.54
	6-Feb-2015				61.04	3800.72
	10-Nov-2014				61.22	3800.54
	12-Aug-2014				61.97	3799.79
	18-Jun-2014				62.07	3799.69
	12-Feb-2014				60.68	3801.08
	6-Nov-2013				60.79	3800.97
	6-Aug-2013				61.07	3800.69
	8-May-2013				60.60	3801.16
	7-Feb-2013				59.43	3802.33
	25-Oct-2012				59.75	3802.01
	1-Aug-2012				60.24	3801.52
	24-Apr-2012				59.81	3801.95
	24-Jan-2012				58.86	3802.90
	8-Dec-2011				58.96	3802.80
	18-Jul-2011				58.36	3803.40
	25-Apr-2011				56.54	3805.22
	17-Jan-2011				56.55	3805.21
	14-Sep-2010				56.34	3805.42
	22-Jun-2010				57.32	3804.44
	22-Mar-2010				56.83	3804.93
	8-Dec-2009				56.63	3805.13
	28-Aug-2009				56.83	3804.93
	26-May-2009				56.41	3805.35
	10-Dec-2008				56.34	3805.42
	28-Sep-2008				56.07	3805.69
	10-Jun-2008				57.46	3804.30
	5-Feb-2008				56.78	3804.98

**TABLE 1. SUMMARY OF MONITORING WELL FLUID GAUGING DATA
DONA ANA DAIRIES, DONA ANA COUNTY, NEW MEXICO**

Monitoring Well	Date Measured	Northing ^a	Easting ^a	Casing Elevation ^b	Depth to Water ^c	Ground Water Elevation ^b
833-09	3-Nov-2023	398280.67	1520918.52	3826.27	29.04	3797.23
	4-Aug-2023				29.22	3797.05
	4-May-2023				29.03	3797.24
	7-Feb-2023				28.26	3798.01
	4-Nov-2022				28.50	3797.77
	5-Aug-2022				29.03	3797.24
	4-May-2022				28.15	3798.12
	9-Feb-2022				27.29	3798.98
	3-Nov-2021				28.11	3798.16
	6-Aug-2021				28.48	3797.79
	5-May-2021				27.57	3798.70
	12-Feb-2021				26.11	3800.16
	4-Nov-2020				26.88	3799.39
	12-Aug-2020				27.02	3799.25
	12-May-2020				27.65	3798.62
	6-Feb-2020				27.06	3799.21
	8-Nov-2019				27.78	3798.49
	2-Aug-2019				27.39	3798.88
	9-May-2019				27.71	3798.56
	20-Feb-2019				26.24	3800.03
	13-Nov-2018				26.73	3799.54
	7-Aug-2018				27.00	3799.27
	14-May-2018				27.19	3799.08
	6-Feb-2018				25.77	3800.50
	7-Nov-2017				25.92	3800.35
	9-Aug-2017				26.22	3800.05
	16-May-2017				28.00	3798.27
	7-Feb-2017				26.48	3799.79
	8-Nov-2016				27.24	3799.03
	16-Aug-2016				26.92	3799.35
	17-May-2016				28.82	3797.45
	10-Feb-2016				27.49	3798.78
	5-Nov-2015				27.98	3798.29
	6-Aug-2015				27.74	3798.53
	6-May-2015				28.86	3797.41
	6-Feb-2015				27.20	3799.07
	5-Nov-2014				27.74	3798.53
	12-Aug-2014				27.71	3798.56
	18-Jun-2014				28.71	3797.56
	12-Feb-2014				26.82	3799.45
	6-Nov-2013				27.49	3798.78
	6-Aug-2013				27.76	3798.51
	8-May-2013				27.31	3798.96
	7-Feb-2013				26.26	3800.01
	25-Oct-2012				26.30	3799.97
	1-Aug-2012				27.21	3799.06
	24-Apr-2012				26.44	3799.83
	24-Jan-2012				25.42	3800.85
	8-Dec-2011				25.08	3801.19
	18-Jul-2011				25.41	3800.86
	25-Apr-2011				22.86	3803.41
	17-Jan-2011				22.87	3803.40
	15-Sep-2010				22.56	3803.71
	22-Jun-2010				23.99	3802.28
	22-Mar-2010				23.20	3803.07
	8-Dec-2009				22.87	3803.40
	28-Aug-2009				22.67	3803.60
	26-May-2009				22.40	3803.87
	10-Dec-2008				22.65	3803.62
	28-Sep-2008				22.18	3804.09
	10-Jun-2008				23.71	3802.56
	5-Feb-2008				23.23	3803.04

**TABLE 1. SUMMARY OF MONITORING WELL FLUID GAUGING DATA
DONA ANA DAIRIES, DONA ANA COUNTY, NEW MEXICO**

Monitoring Well	Date Measured	Northing ^a	Easting ^a	Casing Elevation ^b	Depth to Water ^c	Ground Water Elevation ^b
833-10	3-Nov-2023	396715.89	1520283.6	3820.76	23.53	3797.23
	4-Aug-2023				22.84	3797.92
	4-May-2023				23.51	3797.25
	7-Feb-2023				22.91	3797.85
	4-Nov-2022				23.18	3797.58
	5-Aug-2022				22.85	3797.91
	4-May-2022				22.66	3798.10
	9-Feb-2022				21.84	3798.92
	3-Nov-2021				22.50	3798.26
	6-Aug-2021				22.28	3798.48
	5-May-2021				21.69	3799.07
	12-Feb-2021				20.70	3800.06
	4-Nov-2020				20.90	3799.86
	12-Aug-2020				21.20	3799.56
	12-May-2020				22.00	3798.76
	6-Feb-2020				21.02	3799.74
	8-Nov-2019				21.38	3799.38
	2-Aug-2019				20.35	3800.41
	9-May-2019				22.12	3798.64
	20-Feb-2019				21.04	3799.72
	13-Nov-2018				21.16	3799.60
	7-Aug-2018				20.89	3799.87
	14-May-2018				22.03	3798.73
	6-Feb-2018				20.60	3800.16
	7-Nov-2017				20.65	3800.11
	9-Aug-2017				20.58	3800.18
	16-May-2017				22.66	3798.10
	7-Feb-2017				21.55	3799.21
	8-Nov-2016				21.86	3798.90
	16-Aug-2016				20.55	3800.21
	17-May-2016				23.34	3797.42
	10-Feb-2016				22.38	3798.38
	5-Nov-2015				22.80	3797.96
	6-Aug-2015				20.95	3799.81
	6-May-2015				23.58	3797.18
	6-Feb-2015				22.24	3798.52
	10-Nov-2014				22.95	3797.81
	12-Aug-2014				21.05	3799.71
	18-Jun-2014				22.37	3798.39
	12-Feb-2014				21.61	3799.15
	6-Nov-2013				21.76	3799.00
	6-Aug-2013				21.95	3798.81
	8-May-2013				22.26	3798.50
	7-Feb-2013				21.12	3799.64
	25-Oct-2012				20.93	3799.83
	1-Aug-2012				21.01	3799.75
	24-Apr-2012				21.11	3799.65
	24-Jan-2012				20.14	3800.62
	8-Dec-2011				19.95	3800.81
	18-Jul-2011				19.23	3801.53
	19-Apr-2011				18.67	3802.09
	17-Jan-2011				17.80	3802.96
	15-Sep-2010				17.29	3803.47
	22-Jun-2010				18.80	3801.96
	22-Mar-2010				18.38	3802.38
	8-Dec-2009				17.72	3803.04
	28-Aug-2009				17.22	3803.54
	26-May-2009				17.40	3803.36
	10-Dec-2008				17.71	3803.05
	28-Sep-2008				16.98	3803.78
	10-Jun-2008				18.17	3802.59
	5-Feb-2008				18.11	3802.65

**TABLE 1. SUMMARY OF MONITORING WELL FLUID GAUGING DATA
DONA ANA DAIRIES, DONA ANA COUNTY, NEW MEXICO**

Monitoring Well	Date Measured	Northing ^a	Easting ^a	Casing Elevation ^b	Depth to Water ^c	Ground Water Elevation ^b
Sunset/Desert Land Dairy						
257-01	3-Nov-2023	395856.31	1520572.16	3820.33	23.30	3797.03
	4-Aug-2023				22.50	3797.83
	4-May-2023				22.40	3797.93
	7-Feb-2023				21.59	3798.74
	4-Nov-2022				22.90	3797.43
	5-Aug-2022				22.17	3798.16
	4-May-2022				22.44	3797.89
	9-Feb-2022				21.90	3798.43
	3-Nov-2021				22.62	3797.71
	6-Aug-2021				22.11	3798.22
	5-May-2021				21.83	3798.50
	12-Feb-2021				20.87	3799.46
	4-Nov-2020				20.00	3800.33
	12-Aug-2020				20.16	3800.17
	12-May-2020				20.94	3799.39
	6-Feb-2020				19.00	3801.33
	8-Nov-2019				18.93	3801.40
	2-Aug-2019				19.68	3800.65
	9-May-2019				21.99	3798.34
	19-Feb-2019				20.85	3799.48
	13-Nov-2018				21.16	3799.17
	7-Aug-2018				20.60	3799.73
	14-May-2018				22.23	3798.10
	6-Feb-2018				20.54	3799.79
	7-Nov-2017				20.91	3799.42
	9-Aug-2017				20.73	3799.60
	16-May-2017				22.82	3797.51
	7-Feb-2017				21.70	3798.63
	8-Nov-2016				22.16	3798.17
	16-Aug-2016				20.88	3799.45
	16-May-2016				23.72	3796.61
	10-Feb-2016				22.30	3798.03
	6-Nov-2015				22.99	3797.34
	6-Aug-2015				21.13	3799.20
	6-May-2015				24.16	3796.17
	6-Feb-2015				22.36	3797.97
	10-Nov-2014				23.20	3797.13
	12-Aug-2014				22.50	3797.83
	18-Jun-2014				22.67	3797.66
	12-Feb-2014				21.67	3798.66
6-Nov-2013	22.29	3798.04				
6-Aug-2013	22.52	3797.81				
7-May-2013	21.15	3799.18				
7-Feb-2013	20.38	3799.95				
26-Oct-2012	21.04	3799.29				
1-Aug-2012	20.82	3799.51				
24-Apr-2012	21.01	3799.32				
24-Jan-2012	20.09	3800.24				
8-Dec-2011	20.18	3800.15				
18-Jul-2011	19.75	3800.58				
19-Apr-2011	18.52	3801.81				
18-Jan-2011	17.83	3802.50				
15-Sep-2010	17.15	3803.18				
22-Jun-2010	18.15	3802.18				
22-Mar-2010	18.40	3801.93				
8-Dec-2009	17.66	3802.67				
28-Aug-2009	16.99	3803.34				
26-May-2009	17.41	3802.92				
10-Dec-2008	17.87	3802.46				
27-Sep-2008	16.75	3803.58				
10-Jun-2008	17.88	3802.45				
5-Feb-2008	17.59	3802.74				
14-Nov-2007	18.53	3801.80				
12-Sep-2007	18.10	3802.23				

**TABLE 1. SUMMARY OF MONITORING WELL FLUID GAUGING DATA
DONA ANA DAIRIES, DONA ANA COUNTY, NEW MEXICO**

Monitoring Well	Date Measured	Northing ^a	Easting ^a	Casing Elevation ^b	Depth to Water ^c	Ground Water Elevation ^b
257-02	3-Nov-2023	394728.34	1521030.29	3813.67	17.00	3796.67
	4-Aug-2023				16.12	3797.55
	4-May-2023				17.34	3796.33
	7-Feb-2023				16.80	3796.87
	4-Nov-2022				17.14	3796.53
	5-Aug-2022				17.42	3796.25
	4-May-2022				17.06	3796.61
	9-Feb-2022				16.18	3797.49
	3-Nov-2021				16.42	3797.25
	6-Aug-2021				16.21	3797.46
	5-May-2021				15.90	3797.77
	12-Feb-2021				15.08	3798.59
	4-Nov-2020				15.11	3798.56
	12-Aug-2020				14.88	3798.79
	12-May-2020				15.65	3798.02
	6-Feb-2020				14.90	3798.77
	7-Nov-2019				14.89	3798.78
	2-Aug-2019				15.00	3798.67
	9-May-2019				15.71	3797.96
	19-Feb-2019				15.05	3798.62
	13-Nov-2018				15.50	3798.17
	7-Aug-2018				14.52	3799.15
	14-May-2018				16.30	3797.37
	6-Feb-2018				13.75	3799.92
	7-Nov-2017				14.84	3798.83
	9-Aug-2017				15.14	3798.53
	16-May-2017				16.89	3796.78
	7-Feb-2017				15.68	3797.99
	8-Nov-2016				16.40	3797.27
	16-Aug-2016				15.88	3797.79
	16-May-2016				18.19	3795.48
	10-Feb-2016				16.76	3796.91
	6-Nov-2015				17.65	3796.02
	17-Aug-2015				16.41	3797.26
	6-May-2015				18.20	3795.47
	6-Feb-2015				16.75	3796.92
	10-Nov-2014				17.45	3796.22
	13-Aug-2014				16.50	3797.17
	18-Jun-2014				17.87	3795.80
	12-Feb-2014				15.78	3797.89
6-Nov-2013	16.06	3797.61				
6-Aug-2013	15.95	3797.72				
7-May-2013	15.04	3798.63				
7-Feb-2013	14.79	3798.88				
26-Oct-2012	15.06	3798.61				
1-Aug-2012	14.91	3798.76				
24-Apr-2012	15.27	3798.40				
24-Jan-2012	13.90	3799.77				
8-Dec-2011	14.38	3799.29				
19-Jul-2011	13.50	3800.17				
19-Apr-2011	12.59	3801.08				
18-Jan-2011	11.84	3801.83				
15-Sep-2010	10.86	3802.81				
22-Jun-2010	11.08	3802.59				
22-Mar-2010	12.22	3801.45				
8-Dec-2009	11.52	3802.15				
28-Aug-2009	10.86	3802.81				
26-May-2009	11.38	3802.29				
10-Dec-2008	11.67	3802.00				
27-Sep-2008	9.75	3803.92				
10-Jun-2008	11.82	3801.85				
5-Feb-2008	11.67	3802.00				
14-Nov-2007	12.22	3801.45				
12-Sep-2007	11.55	3802.12				

**TABLE 1. SUMMARY OF MONITORING WELL FLUID GAUGING DATA
DONA ANA DAIRIES, DONA ANA COUNTY, NEW MEXICO**

Monitoring Well	Date Measured	Northing ^a	Easting ^a	Casing Elevation ^b	Depth to Water ^c	Ground Water Elevation ^b
257-03	3-Nov-2023	397935.69	1518746.14	3814.74	14.88	3799.86
	4-Aug-2023				14.16	3800.58
	4-May-2023				14.93	3799.81
	7-Feb-2023				14.08	3800.66
	4-Nov-2022				14.59	3800.15
	5-Aug-2022				14.30	3800.44
	4-May-2022				13.92	3800.82
	9-Feb-2022				14.04	3800.70
	3-Nov-2021				13.54	3801.20
	6-Aug-2021				13.80	3800.94
	5-May-2021				12.38	3802.36
	12-Feb-2021				11.58	3803.16
	4-Nov-2020				11.26	3803.48
	12-Aug-2020				10.86	3803.88
	12-May-2020				Dry	
	6-Feb-2020				12.93	3801.81
	8-Nov-2019				12.03	3802.71
	2-Aug-2019				12.30	3802.44
	9-May-2019				13.48	3801.26
	19-Feb-2019				13.35	3801.39
	13-Nov-2018				12.89	3801.85
	7-Aug-2018				11.82	3802.92
	14-May-2018				13.08	3801.66
	6-Feb-2018				11.86	3802.88
	7-Nov-2017				10.05	3804.69
	9-Aug-2017				11.58	3803.16
	16-May-2017				13.61	3801.13
	7-Feb-2017				13.17	3801.57
	8-Nov-2016				11.80	3802.94
	16-Aug-2016				12.13	3802.61
	16-May-2016				Dry	
	10-Feb-2016				13.45	3801.29
	6-Nov-2015				13.96	3800.78
	6-Aug-2015				11.35	3803.39
	6-May-2015				Dry	
	6-Feb-2015				Dry	
	10-Nov-2014				Dry	
	13-Aug-2014				12.34	3802.40
	18-Jun-2014				12.21	3802.53
	12-Feb-2014				13.49	3801.25
	6-Nov-2013				11.04	3803.70
	6-Aug-2013				11.29	3803.45
	7-May-2013				12.98	3801.76
	7-Feb-2013				12.31	3802.43
	26-Oct-2012				11.61	3803.13
	1-Aug-2012				10.06	3804.68
	24-Apr-2012				11.56	3803.18
	24-Jan-2012				10.89	3803.85
	1-Nov-2011				11.29	3803.45
	18-Jul-2011				8.77	3805.97
19-Apr-2011	9.31	3805.43				
17-Jan-2011	10.04	3804.70				
21-Sep-2010	9.26	3805.48				
22-Jun-2010	9.11	3805.63				
22-Mar-2010	10.45	3804.29				
8-Dec-2009	9.78	3804.96				
28-Aug-2009	9.43	3805.31				
26-May-2009	9.55	3805.19				
10-Dec-2008	10.26	3804.48				
27-Sep-2008	9.73	3805.01				
10-Jun-2008	9.70	3805.04				
5-Feb-2008	11.04	3803.70				
14-Nov-2007	9.03	3805.71				
12-Sep-2007	9.61	3805.13				

**TABLE 1. SUMMARY OF MONITORING WELL FLUID GAUGING DATA
DONA ANA DAIRIES, DONA ANA COUNTY, NEW MEXICO**

Monitoring Well	Date Measured	Northing ^a	Easting ^a	Casing Elevation ^b	Depth to Water ^c	Ground Water Elevation ^b
257/260-01	2-Feb-2018	397678.36	1519948.22	3814.04	Plugged and Abandoned	
	7-Nov-2017				Crops too high	
	18-Aug-2017				12.44	Broken casing
	16-May-2017				12.47	Broken casing
	7-Feb-2017				5.14	Broken casing
	8-Nov-2016				5.65	Broken casing
	16-Aug-2016				NM	NM
	16-May-2016				7.12	Broken casing
	10-Feb-2016				Broken casing	
	6-Nov-2015				12.85	3801.19
	13-Aug-2015				Crops too high	
	6-May-2015				17.12	3796.92
	6-Feb-2015				14.71	3799.33
	5-Nov-2014				14.93	3799.11
	13-Aug-2014				13.28	3800.76
	18-Jun-2014				14.53	3799.51
	12-Feb-2014				14.06	3799.98
	6-Nov-2013				14.01	3800.03
	14-Aug-2013				14.20	3799.84
	7-May-2013				13.83	3800.21
	7-Feb-2013				13.11	3800.93
	26-Oct-2012				13.36	3800.68
	1-Aug-2012				13.05	3800.99
	24-Apr-2012				12.98	3801.06
	30-Jan-2012				12.26	3801.78
	1-Nov-2011				12.79	3801.25
	18-Jul-2011				10.65	3803.39
	26-Apr-2011				11.66	3802.38
	17-Jan-2011				10.44	3803.60
	15-Sep-2010				9.94	3804.10
	22-Jun-2010				10.90	3803.14
	22-Mar-2010				10.71	3803.33
	8-Dec-2009				10.42	3803.62
28-Aug-2009	10.11	3803.93				
26-May-2009	10.00	3804.04				
10-Dec-2008	10.48	3803.56				
27-Sep-2008	9.80	3804.24				
10-Jun-2008	11.00	3803.04				
5-Feb-2008	10.99	3803.05				
14-Nov-2007	11.21	3802.83				
12-Sep-2007	NM	NM				
Additional Wells						
Bruce1	18-Jul-2011	388741.02	1523777.06	3808.92	Destroyed	
	19-Apr-2011				11.17	3797.75
	17-Jan-2011				11.13	3797.79
	15-Sep-2010				10.38	3798.54
	23-Jun-2010				10.99	3797.93
	21-Mar-2010				11.50	3797.42
	8-Dec-2009				11.05	3797.87
	27-Aug-2009				10.41	3798.51
	27-May-2009				10.77	3798.15
	10-Dec-2008				11.28	3797.64
	27-Sep-2008				10.93	3797.99
	10-Jun-2008				11.28	3797.64
	5-Feb-2008				11.47	3797.45
Bruce2	5-Feb-2008	NM	NM	NM	Destroyed	
	10-Jun-2008				8.33	--

**TABLE 1. SUMMARY OF MONITORING WELL FLUID GAUGING DATA
DONA ANA DAIRIES, DONA ANA COUNTY, NEW MEXICO**

Monitoring Well	Date Measured	Northing ^a	Easting ^a	Casing Elevation ^b	Depth to Water ^c	Ground Water Elevation ^b
SOUTHERN AREA						
Del Oro Dairy						
692-01	22-Dec-2015	373615.88	1531529.38	3844.13	Plugged and Abandoned	
	6-Nov-2015				62.12	3782.01
	6-Aug-2015				61.75	3782.38
	6-May-2015				63.02	3781.11
	6-Feb-2015				61.28	3782.85
	5-Nov-2014				61.43	3782.70
	12-Aug-2014				61.27	3782.86
	13-May-2014				60.79	3783.34
	14-Feb-2014				60.38	3783.75
	6-Nov-2013				60.72	3783.41
	6-Aug-2013				60.30	3783.83
	7-May-2013				60.58	3783.55
	7-Feb-2013				59.93	3784.20
	26-Oct-2012				60.10	3784.03
	1-Aug-2012				58.79	3785.34
	24-Apr-2012				58.43	3785.70
	25-Jan-2012				78.58	Pumping
	9-Dec-2011				58.19	3785.94
	18-Jul-2011				57.79	3786.34
	19-Apr-2011				57.39	3786.74
	18-Jan-2011				57.17	3786.96
	15-Sep-2010				57.57	3786.56
	30-Jun-2010				61.15	Pumping
	22-Mar-2010				58.01	3786.12
	9-Dec-2009				58.25	3785.88
	29-Aug-2009				58.19	3785.94
	26-May-2009				57.80	3786.33
	11-Dec-2008				Pumping	NM
	28-Sep-2008				Pumping	NM
	11-Jun-2008				57.75	3786.38
	6-Feb-2008				57.42	3786.71
	14-Nov-2007				57.38	3786.75
	13-Sep-2007				57.46	3786.67

**TABLE 1. SUMMARY OF MONITORING WELL FLUID GAUGING DATA
DONA ANA DAIRIES, DONA ANA COUNTY, NEW MEXICO**

Monitoring Well	Date Measured	Northing ^a	Easting ^a	Casing Elevation ^b	Depth to Water ^c	Ground Water Elevation ^b
692-02	6-Nov-2023	372984.72	1531192.1	3840.84	59.65	3781.19
	7-Aug-2023				59.76	3781.08
	4-May-2023				60.40	3780.44
	7-Feb-2023				59.94	3780.90
	4-Nov-2022				59.70	3781.14
	5-Aug-2022				59.25	3781.59
	4-May-2022				58.46	3782.38
	10-Feb-2022				57.63	3783.21
	3-Nov-2021				58.45	3782.39
	6-Aug-2021				58.05	3782.79
	5-May-2021				56.69	3784.15
	12-Feb-2021				55.03	3785.81
	4-Nov-2020				54.17	3786.67
	12-Aug-2020				53.90	3786.94
	12-May-2020				54.75	3786.09
	6-Feb-2020				53.86	3786.98
	7-Nov-2019				50.24	3790.60
	5-Aug-2019				53.06	3787.78
	9-May-2019				59.91	3780.93
	20-Feb-2019				59.00	3781.84
	13-Nov-2018				60.67	3780.17
	7-Aug-2018				60.82	3780.02
	17-May-2018				60.68	3780.16
	6-Feb-2018				60.60	3780.24
	7-Nov-2017				60.78	3780.06
	9-Aug-2017				61.10	3779.74
	16-May-2017				60.65	3780.19
	7-Feb-2017				60.60	3780.24
	8-Nov-2016				60.65	3780.19
	16-Aug-2016				60.58	3780.26
	17-May-2016				60.25	3780.59
	10-Feb-2016				60.11	3780.73
	6-Nov-2015				59.74	3781.10
	6-Aug-2015				59.66	3781.18
	6-May-2015				59.50	3781.34
	6-Feb-2015				59.02	3781.82
	5-Nov-2014				59.27	3781.57
	12-Aug-2014				59.01	3781.83
	13-May-2014				58.51	3782.33
	14-Feb-2014				58.12	3782.72
6-Nov-2013	57.91	3782.93				
6-Aug-2013	57.60	3783.24				
7-May-2013	57.39	3783.45				
7-Feb-2013	56.86	3783.98				
25-Oct-2012	56.48	3784.36				
1-Aug-2012	56.03	3784.81				
24-Apr-2012	55.71	3785.13				
25-Jan-2012	54.70	3786.14				
13-Dec-2011	54.94	3785.90				
18-Jul-2011	55.10	3785.74				
19-Apr-2011	54.68	3786.16				
18-Jan-2011	54.32	3786.52				
15-Sep-2010	54.39	3786.45				
30-Jun-2010	54.50	3786.34				
22-Mar-2010	54.90	3785.94				
9-Dec-2009	55.11	3785.73				
28-Aug-2009	55.03	3785.81				
26-May-2009	55.38	3785.46				
11-Dec-2008	54.93	3785.91				
28-Sep-2008	54.69	3786.15				
11-Jun-2008	54.93	3785.91				
6-Feb-2008	54.74	3786.10				
14-Nov-2007	54.42	3786.42				
13-Sep-2007	54.61	3786.23				

**TABLE 1. SUMMARY OF MONITORING WELL FLUID GAUGING DATA
DONA ANA DAIRIES, DONA ANA COUNTY, NEW MEXICO**

Monitoring Well	Date Measured	Northing ^a	Easting ^a	Casing Elevation ^b	Depth to Water ^c	Ground Water Elevation ^b
692-04	6-Nov-2023	372982.53	1531555.21	3842.66	Dry	
	7-Aug-2023				Dry	
	4-May-2023				Dry	
	7-Feb-2023				Dry	
	4-Nov-2022				Dry	
	5-Aug-2022				Dry	
	4-May-2022				60.01	3782.65
	10-Feb-2022				59.40	3783.26
	3-Nov-2021				59.90	3782.76
	6-Aug-2021				60.40	3782.26
	5-May-2021				60.35	3782.31
	12-Feb-2021				60.09	3782.57
	4-Nov-2020				59.49	3783.17
	12-Aug-2020				58.70	3783.96
	12-May-2020				59.61	3783.05
	6-Feb-2020				58.03	3784.63
	7-Nov-2019				55.75	3786.91
	5-Aug-2019				58.80	3783.86
	9-May-2019				Dry	
	20-Feb-2019				Dry	
	13-Nov-2018				Dry	
	7-Aug-2018				Dry	
	17-May-2018				Dry	
	6-Feb-2018				Dry	
	7-Nov-2017				Dry	
	9-Aug-2017				Dry	
	16-May-2017				Dry	
	7-Feb-2017				Dry	
	8-Nov-2016				Dry	
	16-Aug-2016				Dry	
	17-May-2016				Dry	
	10-Feb-2016				Dry	
	6-Nov-2015				Dry	
	6-Aug-2015				60.53	3782.13
	6-May-2015				61.99	3780.67
	6-Feb-2015				60.20	3782.46
	5-Nov-2014				60.44	3782.22
	12-Aug-2014				60.13	3782.53
	13-May-2014				59.66	3783.00
	14-Feb-2014				59.18	3783.48
	6-Nov-2013				59.03	3783.63
	6-Aug-2013				58.79	3783.87
	7-May-2013				58.68	3783.98
	7-Feb-2013				58.05	3784.61
	25-Oct-2012				57.62	3785.04
	1-Aug-2012				57.34	3785.32
	24-Apr-2012				57.13	3785.53
25-Jan-2012	56.34	3786.32				
9-Dec-2011	56.91	3785.75				
18-Jul-2011	56.92	3785.74				
19-Apr-2011	56.47	3786.19				
18-Jan-2011	56.15	3786.51				
15-Sep-2010	55.90	3786.76				
30-Jun-2010	56.81	3785.85				
22-Mar-2010	56.81	3785.85				
8-Dec-2009	56.86	3785.80				
28-Aug-2009	56.82	3785.84				
26-May-2009	57.09	3785.57				
11-Dec-2008	56.71	3785.95				
28-Sep-2008	56.41	3786.25				
11-Jun-2008	56.54	3786.12				
6-Feb-2008	56.40	3786.26				
14-Nov-2007	55.95	3786.71				
13-Sep-2007	56.19	3786.47				

**TABLE 1. SUMMARY OF MONITORING WELL FLUID GAUGING DATA
DONA ANA DAIRIES, DONA ANA COUNTY, NEW MEXICO**

Monitoring Well	Date Measured	Northing ^a	Easting ^a	Casing Elevation ^b	Depth to Water ^c	Ground Water Elevation ^b
692-05	6-Nov-2023	374807.26	1532403	3854.26	82.73	3771.53
	7-Aug-2023				81.93	3772.33
	4-May-2023				81.02	3773.24
	7-Feb-2023				81.46	3772.80
	4-Nov-2022				82.30	3771.96
	5-Aug-2022				82.40	3771.86
	4-May-2022				81.60	3772.66
	10-Feb-2022				80.87	3773.39
	3-Nov-2021				81.98	3772.28
	6-Aug-2021				82.70	3771.56
	5-May-2021				81.20	3773.06
	12-Feb-2021				80.58	3773.68
	4-Nov-2020				81.25	3773.01
	12-Aug-2020				80.95	3773.31
	12-May-2020				81.20	3773.06
	6-Feb-2020				80.62	3773.64
	7-Nov-2019				80.62	3773.64
	5-Aug-2019				81.35	3772.91
	9-May-2019				81.34	3772.92
	20-Feb-2019				80.65	3773.61
	13-Nov-2018				81.85	3772.41
	7-Aug-2018				81.75	3772.51
	17-May-2018				81.44	3772.82
	6-Feb-2018				80.20	3774.06
	7-Nov-2017				81.05	3773.21
	9-Aug-2017				81.47	3772.79
	16-May-2017				81.60	3772.66
	7-Feb-2017				80.41	3773.85
	8-Nov-2016				81.78	3772.48
	16-Aug-2016				81.70	3772.56
	17-May-2016				81.25	3773.01
	10-Feb-2016				80.30	3773.96
	6-Nov-2015				81.13	3773.13
	6-Aug-2015				80.85	3773.41
	6-May-2015				81.97	3772.29
	6-Feb-2015				80.08	3774.18
	5-Nov-2014				81.06	3773.20
	12-Aug-2014				81.02	3773.24
	13-May-2014				80.82	3773.44
	13-Feb-2014				79.21	3775.05
6-Nov-2013	NM	NM				
14-Aug-2013	78.12	3776.14				
7-May-2013	79.43	3774.83				
7-Feb-2013	78.86	3775.40				
26-Oct-2012	79.11	3775.15				
1-Aug-2012	78.80	3775.46				
24-Apr-2012	77.96	3776.30				
24-Jan-2012	76.80	3777.46				
9-Dec-2011	77.39	3776.87				
18-Jul-2011	77.59	3776.67				
19-Apr-2011	76.46	3777.80				
18-Jan-2011	75.55	3778.71				
15-Sep-2010	76.14	3778.12				
30-Jun-2010	76.20	3778.06				
22-Mar-2010	75.01	3779.25				
9-Dec-2009	75.52	3778.74				
28-Aug-2009	76.15	3778.11				
26-May-2009	75.65	3778.61				
11-Dec-2008	74.95	3779.31				
28-Sep-2008	75.36	3778.90				
11-Jun-2008	75.72	3778.54				
6-Feb-2008	74.84	3779.42				
14-Nov-2007	75.90	3778.36				
13-Sep-2007	75.84	3778.42				

**TABLE 1. SUMMARY OF MONITORING WELL FLUID GAUGING DATA
DONA ANA DAIRIES, DONA ANA COUNTY, NEW MEXICO**

Monitoring Well	Date Measured	Northing ^a	Easting ^a	Casing Elevation ^b	Depth to Water ^c	Ground Water Elevation ^b
692-06	6-Nov-2023	375054.77	1532411.83	3856.48	84.93	3771.55
	7-Aug-2023				84.69	3771.79
	4-May-2023				84.20	3772.28
	7-Feb-2023				83.38	3773.10
	4-Nov-2022				84.25	3772.23
	5-Aug-2022				84.28	3772.20
	4-May-2022				83.57	3772.91
	10-Feb-2022				82.94	3773.54
	3-Nov-2021				83.83	3772.65
	6-Aug-2021				83.60	3772.88
	5-May-2021				83.08	3773.40
	12-Feb-2021				83.90	3772.58
	4-Nov-2020				83.10	3773.38
	12-Aug-2020				82.69	3773.79
	12-May-2020				83.47	3773.01
	6-Feb-2020				82.88	3773.60
	7-Nov-2019				83.64	3772.84
	5-Aug-2019				83.25	3773.23
	9-May-2019				83.20	3773.28
	20-Feb-2019				82.50	3773.98
	13-Nov-2018				83.69	3772.79
	7-Aug-2018				83.58	3772.90
	17-May-2018				83.25	3773.23
	6-Feb-2018				82.00	3774.48
	7-Nov-2017				82.86	3773.62
	9-Aug-2017				83.28	3773.20
	16-May-2017				83.35	3773.13
	7-Feb-2017				82.20	3774.28
	8-Nov-2016				83.55	3772.93
	16-Aug-2016				83.45	3773.03
	17-May-2016				83.08	3773.40
	10-Feb-2016				82.12	3774.36
	6-Nov-2015				82.92	3773.56
	6-Aug-2015				82.68	3773.80
	6-May-2015				83.11	3773.37
	6-Feb-2015				81.65	3774.83
	5-Nov-2014				82.91	3773.57
	12-Aug-2014				82.88	3773.60
	13-May-2014				81.84	3774.64
	14-Feb-2014				81.31	3775.17
	6-Nov-2013				82.18	3774.30
	6-Aug-2013				81.86	3774.62
7-May-2013	81.22	3775.26				
7-Feb-2013	80.88	3775.60				
26-Oct-2012	81.03	3775.45				
1-Aug-2012	80.69	3775.79				
24-Apr-2012	79.84	3776.64				
30-Jan-2012	78.99	3777.49				
9-Dec-2011	79.32	3777.16				
18-Jul-2011	79.43	3777.05				
19-Apr-2011	78.32	3778.16				
18-Jan-2011	77.44	3779.04				
15-Sep-2010	78.02	3778.46				
30-Jun-2010	78.12	3778.36				
22-Mar-2010	76.91	3779.57				
9-Dec-2009	77.44	3779.04				
28-Aug-2009	78.04	3778.44				
26-May-2009	77.53	3778.95				
11-Dec-2008	76.79	3779.69				
28-Sep-2008	77.25	3779.23				
11-Jun-2008	77.60	3778.88				
6-Feb-2008	76.76	3779.72				
14-Nov-2007	77.80	3778.68				
13-Sep-2007	77.75	3778.73				

**TABLE 1. SUMMARY OF MONITORING WELL FLUID GAUGING DATA
DONA ANA DAIRIES, DONA ANA COUNTY, NEW MEXICO**

Monitoring Well	Date Measured	Northing ^a	Easting ^a	Casing Elevation ^b	Depth to Water ^c	Ground Water Elevation ^b
692-07	6-Nov-2023	374944.88	1532019.81	3848.20	76.61	3771.59
	7-Aug-2023				76.36	3771.84
	4-May-2023				76.30	3771.90
	7-Feb-2023				76.10	3772.10
	4-Nov-2022				76.91	3771.29
	5-Aug-2022				76.28	3771.92
	4-May-2022				75.60	3772.60
	10-Feb-2022				74.77	3773.43
	3-Nov-2021				75.66	3772.54
	6-Aug-2021				75.80	3772.40
	5-May-2021				75.00	3773.20
	12-Feb-2021				74.02	3774.18
	4-Nov-2020				74.88	3773.32
	12-Aug-2020				74.71	3773.49
	12-May-2020				75.03	3773.17
	6-Feb-2020				74.82	3773.38
	7-Nov-2019				75.20	3773.00
	5-Aug-2019				74.95	3773.25
	9-May-2019				75.10	3773.10
	20-Feb-2019				74.11	3774.09
	13-Nov-2018				75.38	3772.82
	7-Aug-2018				75.47	3772.73
	17-May-2018				75.27	3772.93
	6-Feb-2018				73.70	3774.50
	7-Nov-2017				74.54	3773.66
	9-Aug-2017				75.00	3773.20
	16-May-2017				75.44	3772.76
	7-Feb-2017				73.91	3774.29
	8-Nov-2016				75.40	3772.80
	16-Aug-2016				75.27	3772.93
	17-May-2016				75.00	3773.20
	10-Feb-2016				73.87	3774.33
	6-Nov-2015				74.81	3773.39
	6-Aug-2015				74.52	3773.68
	6-May-2015				75.04	3773.16
	6-Feb-2015				73.40	3774.80
	5-Nov-2014				74.65	3773.55
	12-Aug-2014				74.94	3773.26
	13-May-2014				73.69	3774.51
	14-Feb-2014				73.14	3775.06
	6-Nov-2013				74.26	3773.94
	6-Aug-2013				73.92	3774.28
	7-May-2013				73.21	3774.99
	7-Feb-2013				72.55	3775.65
	26-Oct-2012				72.78	3775.42
	1-Aug-2012				72.60	3775.60
	24-Apr-2012				71.84	3776.36
24-Jan-2012	70.30	3777.90				
13-Dec-2011	70.54	3777.66				
18-Jul-2011	71.32	3776.88				
19-Apr-2011	70.22	3777.98				
18-Jan-2011	69.01	3779.19				
15-Sep-2010	69.72	3778.48				
30-Jun-2010	69.87	3778.33				
22-Mar-2010	68.59	3779.61				
9-Dec-2009	68.97	3779.23				
28-Aug-2009	69.71	3778.49				
26-May-2009	69.35	3778.85				
11-Dec-2008	68.38	3779.82				
28-Sep-2008	68.99	3779.21				
11-Jun-2008	69.35	3778.85				
6-Feb-2008	68.44	3779.76				
14-Nov-2007	69.46	3778.74				
13-Sep-2007	69.46	3778.74				

**TABLE 1. SUMMARY OF MONITORING WELL FLUID GAUGING DATA
DONA ANA DAIRIES, DONA ANA COUNTY, NEW MEXICO**

Monitoring Well	Date Measured	Northing ^a	Easting ^a	Casing Elevation ^b	Depth to Water ^c	Ground Water Elevation ^b
692-08	6-Nov-2023	375535.69	1531378.09	3843.09	70.88	3772.21
	7-Aug-2023				70.66	3772.43
	4-May-2023				70.00	3773.09
	7-Feb-2023				69.09	3774.00
	4-Nov-2022				69.94	3773.15
	5-Aug-2022				69.81	3773.28
	4-May-2022				69.02	3774.07
	10-Feb-2022				68.10	3774.99
	3-Nov-2021				69.83	3773.26
	6-Aug-2021				70.20	3772.89
	5-May-2021				69.50	3773.59
	12-Feb-2021				68.70	3774.39
	4-Nov-2020				68.90	3774.19
	12-Aug-2020				68.03	3775.06
	12-May-2020				68.80	3774.29
	6-Feb-2020				67.75	3775.34
	7-Nov-2019				68.95	3774.14
	5-Aug-2019				68.76	3774.33
	9-May-2019				68.78	3774.31
	20-Feb-2019				67.75	3775.34
	13-Nov-2018				68.93	3774.16
	7-Aug-2018				69.66	3773.43
	17-May-2018				70.00	3773.09
	6-Feb-2018				67.29	3775.80
	7-Nov-2017				68.25	3774.84
	9-Aug-2017				68.70	3774.39
	16-May-2017				69.98	3773.11
	7-Feb-2017				67.50	3775.59
	8-Nov-2016				69.25	3773.84
	16-Aug-2016				69.32	3773.77
	17-May-2016				69.25	3773.84
	10-Feb-2016				67.58	3775.51
	6-Nov-2015				68.60	3774.49
	6-Aug-2015				68.45	3774.64
	6-May-2015				69.22	3773.87
	6-Feb-2015				67.12	3775.97
	5-Nov-2014				68.47	3774.62
	12-Aug-2014				68.72	3774.37
	13-May-2014				68.35	3774.74
	14-Feb-2014				67.81	3775.28
6-Nov-2013	68.06	3775.03				
6-Aug-2013	68.52	3774.57				
14-May-2013	67.09	3776.00				
7-Feb-2013	66.64	3776.45				
26-Oct-2012	67.17	3775.92				
1-Aug-2012	66.47	3776.62				
24-Apr-2012	65.84	3777.25				
30-Jan-2012	64.58	3778.51				
9-Dec-2011	64.65	3778.44				
18-Jul-2011	65.79	3777.30				
19-Apr-2011	64.32	3778.77				
18-Jan-2011	62.49	3780.60				
1-Oct-2010	63.83	3779.26				
30-Jun-2010	63.71	3779.38				
22-Mar-2010	62.45	3780.64				
9-Dec-2009	62.57	3780.52				
28-Aug-2009	63.42	3779.67				
26-May-2009	64.03	3779.06				
11-Dec-2008	61.83	3781.26				
28-Sep-2008	63.42	3779.67				
11-Jun-2008	63.40	3779.69				
6-Feb-2008	62.02	3781.07				
14-Nov-2007	63.25	3779.84				
13-Sep-2007	64.02	3779.07				

**TABLE 1. SUMMARY OF MONITORING WELL FLUID GAUGING DATA
DONA ANA DAIRIES, DONA ANA COUNTY, NEW MEXICO**

Monitoring Well	Date Measured	Northing ^a	Easting ^a	Casing Elevation ^b	Depth to Water ^c	Ground Water Elevation ^b
692-09	6-Nov-2023	373575.83	1532395.09	3856.32	86.07	3770.25
	7-Aug-2023				85.80	3770.52
	4-May-2023				85.36	3770.96
	7-Feb-2023				84.52	3771.80
	4-Nov-2022				85.42	3770.90
	5-Aug-2022				85.51	3770.81
	4-May-2022				84.85	3771.47
	10-Feb-2022				84.12	3772.20
	3-Nov-2021				85.08	3771.24
	6-Aug-2021				84.81	3771.51
	5-May-2021				84.40	3771.92
	12-Feb-2021				83.68	3772.64
	4-Nov-2020				84.35	3771.97
	12-Aug-2020				84.09	3772.23
	12-May-2020				84.32	3772.00
	6-Feb-2020				84.02	3772.30
	7-Nov-2019				84.88	3771.44
	2-Aug-2019				84.52	3771.80
	9-May-2019				84.57	3771.75
	20-Feb-2019				83.87	3772.45
	13-Nov-2018				85.10	3771.22
	7-Aug-2018				85.15	3771.17
	17-May-2018				84.89	3771.43
	6-Feb-2018				83.45	3772.87
	7-Nov-2017				84.44	3771.88
	9-Aug-2017				84.85	3771.47
	16-May-2017				84.95	3771.37
	7-Feb-2017				83.68	3772.64
	8-Nov-2016				85.20	3771.12
	16-Aug-2016				85.13	3771.19
	17-May-2016				84.55	3771.77
	10-Feb-2016				83.56	3772.76
	6-Nov-2015				84.47	3771.85
	13-Aug-2015				84.35	3771.97
	6-May-2015				85.04	3771.28
	6-Feb-2015				83.34	3772.98
	10-Nov-2014				83.56	3772.76
	14-Aug-2014				84.03	3772.29
	13-May-2014				83.59	3772.73
	17-Feb-2014				82.51	3773.81
	6-Nov-2013				83.73	3772.59
	6-Aug-2013				83.40	3772.92
	7-May-2013				82.64	3773.68
	7-Feb-2013				82.02	3774.30
	26-Oct-2012				82.18	3774.14
1-Aug-2012	82.11	3774.21				
24-Apr-2012	81.17	3775.15				
25-Jan-2012	79.80	3776.52				
8-Dec-2011	80.44	3775.88				
18-Jul-2011	80.78	3775.54				
19-Apr-2011	79.65	3776.67				
17-Jan-2011	78.52	3777.80				
15-Sep-2010	79.33	3776.99				
30-Jun-2010	79.52	3776.80				
22-Mar-2010	78.13	3778.19				
9-Dec-2009	78.79	3777.53				
28-Aug-2009	79.48	3776.84				
26-May-2009	78.89	3777.43				
11-Dec-2008	78.11	3778.21				
28-Sep-2008	78.55	3777.77				
11-Jun-2008	79.03	3777.29				
6-Feb-2008	78.16	3778.16				
14-Nov-2007	79.15	3777.17				
13-Sep-2007	79.93	3776.39				

**TABLE 1. SUMMARY OF MONITORING WELL FLUID GAUGING DATA
DONA ANA DAIRIES, DONA ANA COUNTY, NEW MEXICO**

Monitoring Well	Date Measured	Northing ^a	Easting ^a	Casing Elevation ^b	Depth to Water ^c	Ground Water Elevation ^b
692-10	6-Nov-2023	374957.71	1531695.32	3847.51	75.90	3771.61
	7-Aug-2023				75.66	3771.85
	7-May-2023				75.25	3772.26
	7-Feb-2023				74.66	3772.85
	4-Nov-2022				75.31	3772.20

**TABLE 1. SUMMARY OF MONITORING WELL FLUID GAUGING DATA
DONA ANA DAIRIES, DONA ANA COUNTY, NEW MEXICO**

Monitoring Well	Date Measured	Northing ^a	Easting ^a	Casing Elevation ^b	Depth to Water ^c	Ground Water Elevation ^b
Anthony Waste Water Treatment Plant						
MW-1	6-Nov-2023	372097.86	1532364.36	3843.03	65.30	3777.73
	7-Aug-2023				65.33	3777.70
	4-May-2023				65.40	3777.63
	7-Feb-2023				65.42	3777.61
	4-Nov-2022				65.10	3777.93
	5-Aug-2022				64.82	3778.21
	4-May-2022				64.62	3778.41
	10-Feb-2022				64.46	3778.57
	3-Nov-2021				64.30	3778.73
	9-Aug-2021				64.02	3779.01
	5-May-2021				63.67	3779.36
	12-Feb-2021				63.13	3779.90
	4-Nov-2020				62.77	3780.26
	12-Aug-2020				62.42	3780.61
	14-May-2020				62.00	3781.03
	6-Feb-2020				61.40	3781.63
	7-Nov-2019				61.93	3781.10
	3-Aug-2019				62.31	3780.72
	9-May-2019				62.12	3780.91
	1-Mar-2019				61.86	3781.17
	13-Nov-2018				61.53	3781.50
	15-Aug-2018				61.59	3781.44
	17-May-2018				61.56	3781.47
	13-Feb-2018				61.22	3781.81
	9-Nov-2017				61.06	3781.97
	10-Aug-2017				61.15	3781.88
	19-May-2017				61.24	3781.79
	7-Feb-2017				60.95	3782.08
	10-Nov-2016				60.91	3782.12
	16-Aug-2016				61.38	3781.65
	17-May-2016				61.40	3781.63
	11-Feb-2016				61.40	3781.63
	11-Nov-2015				61.08	3781.95
	7-Aug-2015				60.85	3782.18
	7-May-2015				61.27	3781.76
	6-Feb-2015				60.96	3782.07
	6-Nov-2014				60.79	3782.24
	12-Aug-2014				60.73	3782.30
	13-May-2014				60.65	3782.38
	14-Feb-2014				60.49	3782.54
	7-Nov-2013				60.28	3782.75
	7-Aug-2013				60.13	3782.90
	8-May-2013				59.72	3783.31
	7-Feb-2013				59.23	3783.80
	26-Oct-2012				58.85	3784.18
	2-Aug-2012				58.79	3784.24
	25-Apr-2012				58.28	3784.75
	9-Dec-2011				58.01	3785.02
	18-Jul-2011				58.44	3784.59
	20-Apr-2011				58.35	3784.68
	18-Jan-2011				58.20	3784.83
	15-Sep-2010				58.28	3784.75
	24-Jun-2010				58.50	3784.53
	22-Mar-2010				58.43	3784.60
	9-Dec-2009				58.15	3784.88
	28-Aug-2009				58.07	3784.96
	27-May-2009				58.41	3784.62

**TABLE 1. SUMMARY OF MONITORING WELL FLUID GAUGING DATA
DONA ANA DAIRIES, DONA ANA COUNTY, NEW MEXICO**

Monitoring Well	Date Measured	Northing ^a	Easting ^a	Casing Elevation ^b	Depth to Water ^c	Ground Water Elevation ^b
MW-2	6-Nov-2023	NM	NM	3843.25	66.66	3776.59
	7-Aug-2023				66.71	3776.54
	4-May-2023				66.88	3776.37
	7-Feb-2023				67.00	3776.25
	4-Nov-2022				66.78	3776.47
	5-Aug-2022				66.42	3776.83
	4-May-2022				66.12	3777.13
	10-Feb-2022				66.03	3777.22
	3-Nov-2021				65.88	3777.37
	9-Aug-2021				65.55	3777.70
	5-May-2021				65.10	3778.15
	12-Feb-2021				64.77	3778.48
	4-Nov-2020				64.09	3779.16
	12-Aug-2020				63.38	3779.87
	13-May-2020				62.80	3780.45
	6-Feb-2020				61.91	3781.34
	7-Nov-2019				62.32	3780.93
	3-Aug-2019				62.97	3780.28
	9-May-2019				63.02	3780.23
	1-Mar-2019				62.62	3780.63
	13-Nov-2018				62.04	3781.21
	15-Aug-2018				61.96	3781.29
	17-May-2018				62.65	3780.60
	13-Feb-2018				62.47	3780.78
	9-Nov-2017				62.20	3781.05
	10-Aug-2017				62.26	3780.99
	19-May-2017				62.32	3780.93
	7-Feb-2017				62.20	3781.05
	10-Nov-2016				61.82	3781.43
	16-Aug-2016				62.34	3780.91
	17-May-2016				62.67	3780.58
	11-Feb-2016				62.73	3780.52
	11-Nov-2015				62.30	3780.95
	7-Aug-2015				62.05	3781.20
	7-May-2015				62.66	3780.59
	6-Feb-2015				62.48	3780.77
	6-Nov-2014				62.22	3781.03
	12-Aug-2014				62.09	3781.16
	13-May-2014				62.06	3781.19
	14-Feb-2014				62.04	3781.21
7-Nov-2013	61.81	3781.44				
7-Aug-2013	62.07	3781.18				
8-May-2013	61.21	3782.04				
7-Feb-2013	60.85	3782.40				
26-Oct-2012	60.42	3782.83				
2-Aug-2012	60.30	3782.95				
25-Apr-2012	59.94	3783.31				
30-Jan-2012	59.30	3783.95				
9-Dec-2011	59.33	3783.92				
18-Jul-2011	59.41	3783.84				
20-Apr-2011	59.42	3783.83				
18-Jan-2011	59.31	3783.94				
15-Sep-2010	59.08	3784.17				
24-Jun-2010	59.37	3783.88				
22-Mar-2010	59.44	3783.81				
9-Dec-2009	59.19	3784.06				
28-Aug-2009	58.98	3784.27				
27-May-2009	59.45	3783.80				

**TABLE 1. SUMMARY OF MONITORING WELL FLUID GAUGING DATA
DONA ANA DAIRIES, DONA ANA COUNTY, NEW MEXICO**

Monitoring Well	Date Measured	Northing ^a	Easting ^a	Casing Elevation ^b	Depth to Water ^c	Ground Water Elevation ^b
MW-3	6-Nov-2023	NM	NM	3841.24	59.13	3782.11
	7-Aug-2023				59.20	3782.04
	4-May-2023				59.26	3781.98
	7-Feb-2023				59.50	3781.74
	4-Nov-2022				59.42	3781.82
	5-Aug-2022				59.05	3782.19
	4-May-2022				58.67	3782.57
	10-Feb-2022				58.45	3782.79
	3-Nov-2021				58.60	3782.64
	9-Aug-2021				58.41	3782.83
	5-May-2021				58.02	3783.22
	12-Feb-2021				57.72	3783.52
	4-Nov-2020				57.50	3783.74
	12-Aug-2020				57.09	3784.15
	14-May-2020				56.34	3784.90
	6-Feb-2020				55.37	3785.87
	7-Nov-2019				55.49	3785.87
	3-Aug-2019				56.65	3784.59
	9-May-2019				57.05	3784.19
	1-Mar-2019				57.18	3784.06
	13-Nov-2018				57.09	3784.15
	15-Aug-2018				57.02	3784.22
	17-May-2018					Dry
	13-Feb-2018					Dry
	9-Nov-2017					Dry
	10-Aug-2017					Dry
	19-May-2017					Dry
	7-Feb-2017					Dry
	10-Nov-2016					Dry
	16-Aug-2016					Dry
	17-May-2016					Dry
	11-Feb-2016					Dry
	11-Nov-2015					Dry
	7-Aug-2015					Dry
	7-May-2015					Dry
	6-Feb-2015					Dry
	6-Nov-2014					Dry
	12-Aug-2014					Dry
	13-May-2014					Dry
	14-Feb-2014					Dry
	7-Nov-2013					Dry
	7-Aug-2013				59.29	3781.95
8-May-2013	58.80	3782.44				
7-Feb-2013	58.36	3782.88				
26-Oct-2012	57.98	3783.26				
2-Aug-2012	57.81	3783.43				
25-Apr-2012	57.32	3783.92				
30-Jan-2012	56.80	3784.44				
8-Dec-2011	56.87	3784.37				
18-Jul-2011	56.98	3784.26				
19-Apr-2011	56.93	3784.31				
18-Jan-2011	56.73	3784.51				
15-Sep-2010		Could not access				
24-Jun-2010	56.91	3784.33				
22-Mar-2010	56.93	3784.31				
9-Dec-2009	56.69	3784.55				
28-Aug-2009	56.54	3784.70				
27-May-2009	56.96	3784.28				

**TABLE 1. SUMMARY OF MONITORING WELL FLUID GAUGING DATA
DONA ANA DAIRIES, DONA ANA COUNTY, NEW MEXICO**

Monitoring Well	Date Measured	Northing ^a	Easting ^a	Casing Elevation ^b	Depth to Water ^c	Ground Water Elevation ^b
ABATEMENT PLAN MONITOR WELLS						
DAD-01	1-Nov-2023	422970.59	1512825.76	3886.16	75.23	3810.93
	2-Aug-2023				75.00	3811.16
	1-May-2023				74.84	3811.32
	2-Feb-2023				74.10	3812.06
	1-Nov-2022				74.85	3811.31
	1-Aug-2022				75.05	3811.11
	2-May-2022				74.15	3812.01
	7-Feb-2022				73.26	3812.90
	1-Nov-2021				73.82	3812.34
	4-Aug-2021				73.66	3812.50
	3-May-2021				73.11	3813.05
	10-Feb-2021				72.87	3813.29
	2-Nov-2020				73.18	3812.98
	10-Aug-2020				73.70	3812.46
	11-May-2020				73.66	3812.50
	4-Feb-2020				72.46	3813.70
	8-Nov-2019				73.11	3813.05
	1-Aug-2019				74.05	3812.11
	9-May-2019				73.59	3812.57
	19-Feb-2019				72.51	3813.65
	12-Nov-2018				72.84	3813.32
	6-Aug-2018				73.70	3812.46
	17-May-2018				73.38	3812.78
	5-Feb-2018				71.87	3814.29
	6-Nov-2017				72.81	3813.35
	7-Aug-2017				73.66	3812.50
	15-May-2017				73.69	3812.47
	7-Feb-2017				72.38	3813.78
	8-Nov-2016				73.39	3812.77
	16-Aug-2016				74.02	3812.14
	17-May-2016				73.90	3812.26
	10-Feb-2016				72.32	3813.84
	6-Nov-2015				73.00	3813.16
	6-Aug-2015				73.54	3812.62
	7-May-2015				72.98	3813.18
	6-Feb-2015				71.45	3814.71
	6-Nov-2014				72.07	3814.09
	12-Aug-2014				71.93	3814.23
	13-May-2014				71.48	3814.68
	12-Feb-2014				70.14	3816.02
6-Nov-2013	70.64	3815.52				
7-Aug-2013	68.63	3817.53				
7-May-2013	68.48	3817.68				
8-Feb-2013	68.59	3817.57				
29-Oct-2012	68.12	3818.04				
30-Jul-2012	68.97	3817.19				
23-Apr-2012	68.19	3817.97				
25-Jan-2012	67.15	3819.01				
8-Dec-2011	67.41	3818.75				
19-Jul-2011	67.41	3818.75				
25-Apr-2011	65.86	3820.30				
18-Jan-2011	65.37	3820.79				
16-Sep-2010	65.86	3820.30				
24-Jun-2010	66.58	3819.58				
21-Mar-2010	65.46	3820.70				
9-Dec-2009	65.32	3820.84				
29-Aug-2009	65.68	3820.48				
26-May-2009	65.43	3820.73				

**TABLE 1. SUMMARY OF MONITORING WELL FLUID GAUGING DATA
DONA ANA DAIRIES, DONA ANA COUNTY, NEW MEXICO**

Monitoring Well	Date Measured	Northing ^a	Easting ^a	Casing Elevation ^b	Depth to Water ^c	Ground Water Elevation ^b
DAD-02	3-Nov-2023	413002.98	1517319.93	3875.82	68.11	3807.71
	3-Aug-2023				68.03	3807.79
	3-May-2023				68.40	3807.42
	3-Feb-2023				67.90	3807.92
	3-Nov-2022				68.08	3807.74
	4-Aug-2022				67.91	3807.91
	3-May-2022				67.38	3808.44
	8-Feb-2022				66.87	3808.95
	2-Nov-2021				67.30	3808.52
	5-Aug-2021				66.92	3808.90
	4-May-2021				66.46	3809.36
	11-Feb-2021				66.19	3809.63
	3-Nov-2020				66.83	3808.99
	11-Aug-2020				67.11	3808.71
	11-May-2020				67.75	3808.07
	5-Feb-2020				66.20	3809.62
	8-Nov-2019				65.05	3810.77
	1-Aug-2019				66.91	3808.91
	8-May-2019				66.46	3809.36
	19-Feb-2019				65.90	3809.92
	12-Nov-2018				66.40	3809.42
	6-Aug-2018				66.42	3809.40
	17-May-2018				66.10	3809.72
	5-Feb-2018				65.63	3810.19
	6-Nov-2017				66.21	3809.61
	7-Aug-2017				66.75	3809.07
	16-May-2017				66.74	3809.08
	7-Feb-2017				66.41	3809.41
	8-Nov-2016				67.08	3808.74
	16-Aug-2016				67.55	3808.27
	17-May-2016				67.30	3808.52
	10-Feb-2016				66.83	3808.99
	6-Nov-2015				67.21	3808.61
	6-Aug-2015				67.25	3808.57
	7-May-2015				67.10	3808.72
	6-Feb-2015				66.30	3809.52
	6-Nov-2014				66.60	3809.22
	12-Aug-2014				66.55	3809.27
	13-May-2014				66.01	3809.81
	12-Feb-2014				65.42	3810.40
7-Nov-2013	65.55	3810.27				
7-Aug-2013	65.01	3810.81				
8-May-2013	64.56	3811.26				
8-Feb-2013	64.04	3811.78				
29-Oct-2012	64.11	3811.71				
31-Jul-2012	64.03	3811.79				
24-Apr-2012	63.45	3812.37				
25-Jan-2012	62.91	3812.91				
8-Dec-2011	63.07	3812.75				
19-Jul-2011	62.63	3813.19				
18-Apr-2011	62.11	3813.71				
17-Jan-2011	61.37	3814.45				
16-Sep-2010	61.79	3814.03				
25-Jun-2010	62.95	3812.87				
21-Mar-2010	61.43	3814.39				
9-Dec-2009	61.46	3814.36				
29-Aug-2009	61.65	3814.17				
26-May-2009	61.59	3814.23				

**TABLE 1. SUMMARY OF MONITORING WELL FLUID GAUGING DATA
DONA ANA DAIRIES, DONA ANA COUNTY, NEW MEXICO**

Monitoring Well	Date Measured	Northing ^a	Easting ^a	Casing Elevation ^b	Depth to Water ^c	Ground Water Elevation ^b
DAD-03	3-Nov-2023	407721.31	1516497.85	3820.58	15.01	3805.57
	3-Aug-2023				15.50	3805.08
	3-May-2023				15.97	3804.61
	3-Feb-2023				15.21	3805.37
	3-Nov-2022				15.30	3805.28
	4-Aug-2022				15.08	3805.50
	3-May-2022				14.50	3806.08
	8-Feb-2022				13.71	3806.87
	2-Nov-2021				14.16	3806.42
	5-Aug-2021				13.80	3806.78
	4-May-2021				13.10	3807.48
	11-Feb-2021				12.35	3808.23
	3-Nov-2020				12.61	3807.97
	11-Aug-2020				12.67	3807.91
	11-May-2020				12.89	3807.69
	5-Feb-2020				12.57	3808.01
	7-Nov-2019				12.21	3808.37
	1-Aug-2019				13.50	3807.08
	9-May-2019				13.29	3807.29
	19-Feb-2019				12.45	3808.13
	12-Nov-2018				12.55	3808.03
	7-Aug-2018				12.38	3808.20
	17-May-2018				12.41	3808.17
	5-Feb-2018				11.55	3809.03
	7-Nov-2017				11.62	3808.96
	9-Aug-2017				12.47	3808.11
	16-May-2017				13.31	3807.27
	7-Feb-2017				12.50	3808.08
	8-Nov-2016				NM	NM
	17-Aug-2016				13.12	3807.46
	20-May-2016				13.82	3806.76
	10-Feb-2016				13.07	3807.51
	6-Nov-2015				13.20	3807.38
	6-Aug-2015				13.41	3807.17
	7-May-2015				13.52	3807.06
	6-Feb-2015				12.87	3807.71
	6-Nov-2014				12.94	3807.64
	12-Aug-2014				13.20	3807.38
	13-May-2014				13.39	3807.19
	17-Feb-2014				12.66	3807.92
11-Dec-2013	12.67	3807.91				
14-Aug-2013	12.36	3808.22				
8-May-2013	11.87	3808.71				
8-Feb-2013	11.07	3809.51				
29-Oct-2012	10.93	3809.65				
31-Jul-2012	10.90	3809.68				
24-Apr-2012	10.97	3809.61				
25-Jan-2012	10.60	3809.98				
8-Dec-2011	10.70	3809.88				
19-Jul-2011	10.29	3810.29				
18-Apr-2011	10.12	3810.46				
24-Jan-2011	9.36	3811.22				
16-Sep-2010	9.40	3811.18				
24-Jun-2010	9.97	3810.61				
21-Mar-2010	9.90	3810.68				
9-Dec-2009	9.79	3810.79				
29-Aug-2009	9.72	3810.86				
26-May-2009	9.89	3810.69				

**TABLE 1. SUMMARY OF MONITORING WELL FLUID GAUGING DATA
DONA ANA DAIRIES, DONA ANA COUNTY, NEW MEXICO**

Monitoring Well	Date Measured	Northing ^a	Easting ^a	Casing Elevation ^b	Depth to Water ^c	Ground Water Elevation ^b
DAD-04	3-Nov-2023	404576.66	1517413.28	3821.47	18.25	3802.33
	4-Aug-2023				18.12	3802.46
	3-May-2023				DRY	
	6-Feb-2023				DRY	
	3-Nov-2022				18.15	3803.32
	4-Aug-2022				17.87	3803.60
	3-May-2022				17.22	3804.25
	8-Feb-2022				17.05	3804.42
	2-Nov-2021				17.93	3803.54
	6-Aug-2021				18.10	3803.37
	4-May-2021				16.26	3805.21
	11-Feb-2021				15.86	3805.61
	3-Nov-2020				16.10	3805.37
	11-Aug-2020				16.68	3804.79
	12-May-2020				16.78	3804.69
	5-Feb-2020				15.70	3805.77
	8-Nov-2019				16.87	3804.60
	1-Aug-2019				17.14	3804.33
	9-May-2019				17.82	3803.65
	19-Feb-2019				15.85	3805.62
	12-Nov-2018				16.15	3805.32
	7-Aug-2018				15.76	3805.71
	17-May-2018				16.66	3804.81
	6-Feb-2018				14.44	3807.03
	6-Nov-2017				14.49	3806.98
	7-Aug-2017				15.55	3805.92
	16-May-2017				17.58	3803.89
	7-Feb-2017				15.59	3805.88
	8-Nov-2016				15.57	3805.90
	16-Aug-2016				16.15	3805.32
	17-May-2016				17.20	3804.27
	10-Feb-2016				15.21	3806.26
	6-Nov-2015				15.98	3805.49
	6-Aug-2015				16.77	3804.70
	7-May-2015				17.57	3803.90
	6-Feb-2015				15.55	3805.92
	6-Nov-2014				15.29	3806.18
	13-Aug-2014				15.81	3805.66
	13-May-2014				17.36	3804.11
	13-Feb-2014				15.45	3806.02
	7-Nov-2013				16.91	3804.56
7-Aug-2013	17.11	3804.36				
8-May-2013	15.02	3806.45				
8-Feb-2013	14.48	3806.99				
29-Oct-2012	15.10	3806.37				
31-Jul-2012	14.37	3807.10				
24-Apr-2012	14.27	3807.20				
25-Jan-2012	13.40	3808.07				
8-Dec-2011	13.84	3807.63				
19-Jul-2011	13.63	3807.84				
18-Apr-2011	13.21	3808.26				
17-Jan-2011	12.71	3808.76				
16-Sep-2010	12.14	3809.33				
23-Jun-2010	12.59	3808.88				
21-Mar-2010	12.88	3808.59				
9-Dec-2009	12.10	3809.37				
29-Aug-2009	12.13	3809.34				
26-May-2009	12.31	3809.16				

**TABLE 1. SUMMARY OF MONITORING WELL FLUID GAUGING DATA
DONA ANA DAIRIES, DONA ANA COUNTY, NEW MEXICO**

Monitoring Well	Date Measured	Northing ^a	Easting ^a	Casing Elevation ^b	Depth to Water ^c	Ground Water Elevation ^b
DAD-05	3-Nov-2023	396712.87	1519102.06	3816.01	16.90	3799.11
	4-Aug-2023				16.03	3799.98
	4-May-2023				16.83	3799.18
	7-Feb-2023				16.74	3799.27
	4-Nov-2022				16.03	3799.98
	5-Aug-2022				15.37	3800.64
	4-May-2022				15.78	3800.23
	9-Feb-2022				16.32	3799.69
	3-Nov-2021				16.21	3799.80
	6-Aug-2021				15.55	3800.46
	4-May-2021				15.42	3800.59
	12-Feb-2021				14.88	3801.13
	4-Nov-2020				15.16	3800.85
	12-Aug-2020				14.93	3801.08
	12-May-2020				15.60	3800.41
	6-Feb-2020				15.30	3800.71
	8-Nov-2019				15.51	3800.50
	2-Aug-2019				14.21	3801.80
	9-May-2019				16.19	3799.82
	19-Feb-2019				15.65	3800.36
	13-Nov-2018				15.28	3800.73
	7-Aug-2018				14.25	3801.76
	14-May-2018				15.45	3800.56
	6-Feb-2018				14.95	3801.06
	7-Nov-2017				13.75	3802.26
	7-Aug-2017				13.70	3802.31
	16-May-2017				15.96	3800.05
	7-Feb-2017				15.86	3800.15
	8-Nov-2016				15.46	3800.55
	16-Aug-2016				14.28	3801.73
	17-May-2016				16.85	3799.16
	10-Feb-2016				16.55	3799.46
	6-Nov-2015				16.57	3799.44
	13-Aug-2015				14.38	3801.63
	7-May-2015				18.16	3797.85
	6-Feb-2015				16.60	3799.41
	10-Nov-2014				17.25	3798.76
	13-Aug-2014				14.33	3801.68
	13-May-2014				17.24	3798.77
	13-Feb-2014				15.82	3800.19
7-Nov-2013	15.39	3800.62				
7-Aug-2013	15.32	3800.69				
8-May-2013	15.78	3800.23				
8-Feb-2013	15.08	3800.93				
29-Oct-2012	14.85	3801.16				
2-Aug-2012	14.17	3801.84				
24-Apr-2012	14.14	3801.87				
25-Jan-2012	14.11	3801.90				
8-Dec-2011	14.05	3801.96				
18-Jul-2011	12.31	3803.70				
18-Apr-2011	12.58	3803.43				
17-Jan-2011	12.50	3803.51				
16-Sep-2010	11.87	3804.14				
23-Jun-2010	12.95	3803.06				
21-Mar-2010	12.92	3803.09				
9-Dec-2009	12.13	3803.88				
29-Aug-2009	11.85	3804.16				
26-May-2009	12.07	3803.94				

**TABLE 1. SUMMARY OF MONITORING WELL FLUID GAUGING DATA
DONA ANA DAIRIES, DONA ANA COUNTY, NEW MEXICO**

Monitoring Well	Date Measured	Northing ^a	Easting ^a	Casing Elevation ^b	Depth to Water ^c	Ground Water Elevation ^b
DAD-06	4-Nov-2022	404273.19	1522081.00	3887.71	Plugged and Abandoned	
	4-May-2022				Dry	
	4-May-2022				Dry	
	9-Feb-2022				Dry	
	2-Nov-2021				Dry	
	5-Aug-2021				Dry	
	4-May-2021				Dry	
	11-Feb-2021				Dry	
	3-Nov-2020				Dry	
	11-Aug-2020				Dry	
	12-May-2020				Dry	
	5-Feb-2020				Dry	
	8-Nov-2019				Dry	
	5-Aug-2019				Dry	
	9-May-2019				Dry	
	14-Mar-2019				Dry	
	13-Nov-2018				Dry	
	7-Aug-2018				Dry	
	17-May-2018				Dry	
	6-Feb-2018				Dry	
	6-Nov-2017				Dry	
	7-Aug-2017				Dry	
	16-May-2017				Dry	
	7-Feb-2017				Dry	
	8-Nov-2016				Dry	
	16-Aug-2016				Dry	
	17-May-2016				Dry	
	10-Feb-2016				Dry	
	6-Nov-2015				Dry	
	6-Aug-2015				Dry	
	7-May-2015				Dry	
	6-Feb-2015				Dry	
	6-Nov-2014				Dry	
	12-Aug-2014				Dry	
	13-May-2014				Dry	
	13-Feb-2014				Dry	
	7-Nov-2013				Dry	
	7-Aug-2013				Dry	
	8-May-2013				82.79	3804.92
	8-Feb-2013				82.38	3805.33
29-Oct-2012	82.47	3805.24				
1-Aug-2012	82.20	3805.51				
24-Apr-2012	82.13	3805.58				
25-Jan-2012	81.32	3806.39				
8-Dec-2011	81.55	3806.16				
18-Jul-2011	80.94	3806.77				
20-Apr-2011	80.16	3807.55				
17-Jan-2011	79.43	3808.28				
16-Sep-2010	79.68	3808.03				
25-Jun-2010	80.33	3807.38				
21-Mar-2010	79.85	3807.86				
9-Dec-2009	79.95	3807.76				
29-Aug-2009	80.46	3807.25				
26-May-2009	80.32	3807.39				
DAD-06R	3-Nov-2023	404287.43	1522077.30	3887.80	86.02	3801.78
	4-Aug-2023				86.20	3801.60
	3-May-2023				85.90	3801.90
	6-Feb-2023				85.55	3802.25
	7-Nov-2022				85.70	3802.10

**TABLE 1. SUMMARY OF MONITORING WELL FLUID GAUGING DATA
DONA ANA DAIRIES, DONA ANA COUNTY, NEW MEXICO**

Monitoring Well	Date Measured	Northing ^a	Easting ^a	Casing Elevation ^b	Depth to Water ^c	Ground Water Elevation ^b
DAD-07	3-Nov-2023	399270.18	1524320.88	3891.38	93.47	3797.91
	4-Aug-2023				93.31	3798.07
	3-May-2023				93.15	3798.23
	7-Feb-2023				93.08	3798.30
	4-Nov-2022				93.10	3798.28
	5-Aug-2022				92.92	3798.46
	4-May-2022				92.63	3798.75
	9-Feb-2022				92.40	3798.98
	3-Nov-2021				91.88	3799.50
	6-Aug-2021				91.10	3800.28
	5-May-2021				92.24	3799.14
	12-Feb-2021				92.06	3799.32
	4-Nov-2020				92.50	3798.88
	12-Aug-2020				92.10	3799.28
	12-May-2020				92.56	3798.82
	6-Feb-2020				92.36	3799.02
	7-Nov-2019				92.70	3798.68
	2-Aug-2019				92.67	3798.71
	9-May-2019				92.67	3798.71
	9-May-2019				90.29	3801.09
	20-Feb-2019				92.24	3799.14
	13-Nov-2018				92.59	3798.79
	7-Aug-2018				92.45	3798.93
	14-May-2018				92.27	3799.11
	5-Feb-2018				92.16	3799.22
	6-Nov-2017				92.47	3798.91
	7-Aug-2017				92.72	3798.66
	15-May-2017				92.61	3798.77
	7-Feb-2017				92.40	3798.98
	8-Nov-2016				93.77	3797.61
	16-Aug-2016				92.94	3798.44
	17-May-2016				92.81	3798.57
	10-Feb-2016				92.64	3798.74
	6-Nov-2015				92.59	3798.79
	6-Aug-2015				92.43	3798.95
	7-May-2015				92.46	3798.92
	6-Feb-2015				92.28	3799.10
	6-Nov-2014				92.34	3799.04
	12-Aug-2014				92.12	3799.26
	13-May-2014				91.88	3799.50
13-Feb-2014	91.37	3800.01				
7-Nov-2013	91.60	3799.78				
7-Aug-2013	91.19	3800.19				
8-May-2013	90.89	3800.49				
8-Feb-2013	90.13	3801.25				
29-Oct-2012	90.34	3801.04				
2-Aug-2012	90.38	3801.00				
24-Apr-2012	90.25	3801.13				
25-Jan-2012	89.75	3801.63				
8-Dec-2011	89.35	3802.03				
18-Jul-2011	88.98	3802.40				
20-Apr-2011	88.34	3803.04				
17-Jan-2011	87.94	3803.44				
16-Sep-2010	88.29	3803.09				
25-Jun-2010	88.49	3802.89				
21-Mar-2010	88.00	3803.38				
9-Dec-2009	88.19	3803.19				
29-Aug-2009	88.45	3802.93				
26-May-2009	88.14	3803.24				

**TABLE 1. SUMMARY OF MONITORING WELL FLUID GAUGING DATA
DONA ANA DAIRIES, DONA ANA COUNTY, NEW MEXICO**

Monitoring Well	Date Measured	Northing ^a	Easting ^a	Casing Elevation ^b	Depth to Water ^c	Ground Water Elevation ^b
DAD-08	3-Nov-2023	395287.38	1522575.07	3849.15	53.58	3795.57
	4-Aug-2023				53.28	3795.87
	4-May-2023				53.10	3796.05
	7-Feb-2023				52.80	3796.35
	4-Nov-2022				53.18	3795.97
	5-Aug-2022				53.40	3795.75
	4-May-2022				52.74	3796.41
	9-Feb-2022				51.83	3797.32
	3-Nov-2021				52.60	3796.55
	6-Aug-2021				52.90	3796.25
	5-May-2021				51.89	3797.26
	12-Feb-2021				51.00	3798.15
	4-Nov-2020				51.32	3797.83
	12-Aug-2020				50.89	3798.26
	12-May-2020				51.55	3797.60
	6-Feb-2020				50.99	3798.16
	8-Nov-2019				50.31	3798.84
	2-Aug-2019				51.90	3797.25
	9-May-2019				51.68	3797.47
	20-Feb-2019				50.77	3798.38
	13-Nov-2018				51.58	3797.57
	7-Aug-2018				51.70	3797.45
	14-May-2018				52.20	3796.95
	6-Feb-2018				50.88	3798.27
	7-Nov-2017				51.15	3798.00
	7-Aug-2017				51.71	3797.44
	16-May-2017				52.95	3796.20
	7-Feb-2017				51.74	3797.41
	8-Nov-2016				52.45	3796.70
	16-Aug-2016				52.89	3796.26
	17-May-2016				53.80	3795.35
	10-Feb-2016				52.64	3796.51
	6-Nov-2015				53.04	3796.11
	6-Aug-2015				52.90	3796.25
	7-May-2015				53.22	3795.93
	6-Feb-2015				51.97	3797.18
	6-Nov-2014				52.61	3796.54
	13-Aug-2014				53.09	3796.06
	13-May-2014				53.98	3795.17
	13-Feb-2014				51.31	3797.84
7-Nov-2013	51.50	3797.65				
7-Aug-2013	53.18	3795.97				
8-May-2013	52.43	3796.72				
8-Feb-2013	50.37	3798.78				
29-Oct-2012	49.86	3799.29				
1-Aug-2012	50.34	3798.81				
24-Apr-2012	50.34	3798.81				
25-Jan-2012	49.62	3799.53				
13-Dec-2011	50.12	3799.03				
18-Jul-2011	49.97	3799.18				
20-Apr-2011	48.87	3800.28				
18-Jan-2011	47.80	3801.35				
17-Sep-2010	47.05	3802.10				
25-Jun-2010	48.06	3801.09				
21-Mar-2010	47.76	3801.39				
9-Dec-2009	47.42	3801.73				
29-Aug-2009	47.18	3801.97				
26-May-2009	47.38	3801.77				

**TABLE 1. SUMMARY OF MONITORING WELL FLUID GAUGING DATA
DONA ANA DAIRIES, DONA ANA COUNTY, NEW MEXICO**

Monitoring Well	Date Measured	Northing ^a	Easting ^a	Casing Elevation ^b	Depth to Water ^c	Ground Water Elevation ^b
DAD-09	3-Nov-2023	373259.30	1530905.70	3838.03	57.00	3781.03
	7-Aug-2023				57.11	3780.92
	4-May-2023				57.21	3780.82
	7-Feb-2023				57.03	3781.00
	4-Nov-2022				56.76	3781.27
	5-Aug-2022				56.22	3781.81
	4-May-2022				55.40	3782.63
	10-Feb-2022				54.53	3783.50
	3-Nov-2021				55.25	3782.78
	6-Aug-2021				55.76	3782.27
	5-May-2021				55.78	3782.25
	12-Feb-2021				55.66	3782.37
	4-Nov-2020				55.94	3782.09
	12-Aug-2020				55.90	3782.13
	12-May-2020				55.75	3782.28
	6-Feb-2020				54.85	3783.18
	8-Nov-2019				54.31	3783.72
	2-Aug-2019				55.00	3783.03
	9-May-2019				55.99	3782.04
	20-Feb-2019				57.75	3780.28
	13-Nov-2018				58.15	3779.88
	7-Aug-2018				58.32	3779.71
	14-May-2018				58.25	3779.78
	6-Feb-2018				58.10	3779.93
	7-Nov-2017				58.28	3779.75
	9-Aug-2017				58.73	3779.30
	16-May-2017				58.56	3779.47
	7-Feb-2017				58.25	3779.78
	8-Nov-2016				58.46	3779.57
	16-Aug-2016				58.28	3779.75
	17-May-2016				57.91	3780.12
	10-Feb-2016				57.75	3780.28
	6-Nov-2015				57.46	3780.57
	6-Aug-2015				57.36	3780.67
	7-May-2015				57.19	3780.84
	6-Feb-2015				56.90	3781.13
	6-Nov-2014				56.69	3781.34
	12-Aug-2014				56.57	3781.46
	13-May-2014				56.14	3781.89
	13-Feb-2014				55.65	3782.38
7-Nov-2013	55.17	3782.86				
7-Aug-2013	55.35	3782.68				
7-May-2013	54.94	3783.09				
8-Feb-2013	54.67	3783.36				
29-Oct-2012	54.13	3783.90				
2-Aug-2012	53.86	3784.17				
24-Apr-2012	53.40	3784.63				
25-Jan-2012	52.67	3785.36				
13-Dec-2011	52.62	3785.41				
18-Jul-2011	52.28	3785.75				
18-Apr-2011	51.89	3786.14				
17-Jan-2011	51.09	3786.94				
17-Sep-2010	51.55	3786.48				
29-Jun-2010	52.20	3785.83				
21-Mar-2010	51.84	3786.19				
9-Dec-2009	52.12	3785.91				
29-Aug-2009	52.23	3785.80				
26-May-2009	52.49	3785.54				

**TABLE 1. SUMMARY OF MONITORING WELL FLUID GAUGING DATA
DONA ANA DAIRIES, DONA ANA COUNTY, NEW MEXICO**

Monitoring Well	Date Measured	Northing ^a	Easting ^a	Casing Elevation ^b	Depth to Water ^c	Ground Water Elevation ^b
DAD-10	6-Nov-2023	372980.55	1532375.33	3854.93	84.69	3770.24
	7-Aug-2023				83.83	3771.10
	4-May-2023				84.14	3770.79
	7-Feb-2023				83.45	3771.48
	4-Nov-2022				84.06	3770.87
	5-Aug-2022				84.64	3770.29
	4-May-2022				84.08	3770.85
	10-Feb-2022				83.25	3771.68
	3-Nov-2021				84.12	3770.81
	6-Aug-2021				83.97	3770.96
	5-May-2021				83.93	3771.00
	12-Feb-2021				83.01	3771.92
	4-Nov-2020				83.78	3771.15
	12-Aug-2020				83.10	3771.83
	12-May-2020				83.44	3771.49
	6-Feb-2020				82.95	3771.98
	7-Nov-2019				83.76	3771.17
	2-Aug-2019				83.38	3771.55
	9-May-2019				83.71	3771.22
	20-Feb-2019				82.71	3772.22
	13-Nov-2018				84.08	3770.85
	7-Aug-2018				84.45	3770.48
	17-May-2018				84.35	3770.58
	5-Feb-2018				82.54	3772.39
	6-Nov-2017				83.29	3771.64
	9-Aug-2017				83.76	3771.17
	16-May-2017				84.45	3770.48
	7-Feb-2017				82.58	3772.35
	8-Nov-2016				84.47	3770.46
	16-Aug-2016				84.45	3770.48
	17-May-2016				83.77	3771.16
	10-Feb-2016				82.52	3772.41
	6-Nov-2015				83.80	3771.13
	6-Aug-2015				83.56	3771.37
	7-May-2015				83.93	3771.00
	6-Feb-2015				82.18	3772.75
	6-Nov-2014				83.31	3771.62
	12-Aug-2014				83.25	3771.68
	13-May-2014				83.61	3771.32
	17-Feb-2014				81.59	3773.34
7-Nov-2013	82.75	3772.18				
7-Aug-2013	82.78	3772.15				
7-May-2013	81.77	3773.16				
8-Feb-2013	80.87	3774.06				
29-Oct-2012	81.02	3773.91				
2-Aug-2012	81.47	3773.46				
24-Apr-2012	80.36	3774.57				
25-Jan-2012	78.76	3776.17				
13-Dec-2011	79.07	3775.86				
18-Jul-2011	80.29	3774.64				
20-Apr-2011	79.13	3775.80				
17-Jan-2011	77.82	3777.11				
17-Sep-2010	78.66	3776.27				
29-Jun-2010	78.59	3776.34				
21-Mar-2010	77.19	3777.74				
9-Dec-2009	77.92	3777.01				
29-Aug-2009	78.72	3776.21				
26-May-2009	77.90	3777.03				

**TABLE 1. SUMMARY OF MONITORING WELL FLUID GAUGING DATA
DONA ANA DAIRIES, DONA ANA COUNTY, NEW MEXICO**

Monitoring Well	Date Measured	Northing ^a	Easting ^a	Casing Elevation ^b	Depth to Water ^c	Ground Water Elevation ^b
DAD-11 Vertical Delineation	2-Nov-2023	416211.35	1513814.71	3835.90	24.12	3811.78
	3-Aug-2023				23.51	3812.39
	2-May-2023				24.19	3811.71
	3-Feb-2023				24.05	3811.85
	2-Nov-2022				23.31	3812.59
	4-Aug-2022				22.52	3813.38
	3-May-2022				23.12	3812.78
	8-Feb-2022				23.06	3812.84
	2-Nov-2021				22.75	3813.15
	5-Aug-2021				22.52	3813.38
	4-May-2021				22.45	3813.45
	11-Feb-2021				21.86	3814.04
	3-Nov-2020				21.38	3814.52
	11-Aug-2020				21.32	3814.58
	12-May-2020				22.07	3813.83
	5-Feb-2020				21.54	3814.36
	8-Nov-2019				20.17	3815.73
	1-Aug-2019				21.65	3814.25
	8-May-2019				21.95	3813.95
	19-Feb-2019				21.35	3814.55
	12-Nov-2018				21.45	3814.45
	6-Aug-2018				20.21	3815.69
	17-May-2018				22.15	3813.75
	6-Feb-2018				21.38	3814.52
	6-Nov-2017				21.15	3814.75
	8-Aug-2017				21.55	3814.35
	15-May-2017				22.79	3813.11
	7-Feb-2017				22.75	3813.15
	8-Nov-2016				22.20	3813.70
	16-Aug-2016				22.20	3813.70
	17-May-2016				23.54	3812.36
	10-Feb-2016				23.14	3812.76
	6-Nov-2015				22.92	3812.98
	6-Aug-2015				22.38	3813.52
	7-May-2015				22.64	3813.26
	6-Feb-2015				22.50	3813.40
	10-Nov-2014				21.80	3814.10
	13-Aug-2014				20.77	3815.13
	12-May-2014				21.34	3814.56
	12-Feb-2014				21.64	3814.26
	7-Nov-2013				20.76	3815.14
	7-Aug-2013				20.17	3815.73
	8-May-2013				20.70	3815.20
	8-Feb-2013				19.25	3816.65
	29-Oct-2012				19.07	3816.83
	30-Jul-2012				18.57	3817.33
	24-Apr-2012				19.12	3816.78
25-Jan-2012	18.40	3817.50				
13-Dec-2011	18.75	3817.15				
19-Jul-2011	17.54	3818.36				
19-Apr-2011	17.31	3818.59				
17-Jan-2011	16.99	3818.91				
15-Sep-2010	16.24	3819.66				
23-Jun-2010	16.53	3819.37				
22-Mar-2010	17.29	3818.61				
8-Dec-2009	16.82	3819.08				
28-Aug-2009	16.63	3819.27				
26-May-2009	16.92	3818.98				
10-Dec-2008	17.05	3818.85				
27-Sep-2008	16.65	3819.25				
10-Jun-2008	17.53	3818.37				
6-Feb-2008	17.33	3818.57				
13-Nov-2007	17.19	3818.71				
13-Sep-2007	16.61	3819.29				

**TABLE 1. SUMMARY OF MONITORING WELL FLUID GAUGING DATA
DONA ANA DAIRIES, DONA ANA COUNTY, NEW MEXICO**

Monitoring Well	Date Measured	Northing ^a	Easting ^a	Casing Elevation ^b	Depth to Water ^c	Ground Water Elevation ^b
DAD-12 Vertical Delineation	2-Nov-2023	419731.54	1512274.77	3866.72	54.66	3812.06
	3-Aug-2023				54.01	3812.71
	2-May-2023				53.05	3813.67
	2-Feb-2023				52.30	3814.42
	1-Nov-2022				52.86	3813.86
	2-Aug-2022				52.37	3814.35
	2-May-2022				52.90	3813.82
	7-Feb-2022				52.66	3814.06
	1-Nov-2021				52.15	3814.57
	4-Aug-2021				51.51	3815.21
	3-May-2021				51.70	3815.02
	10-Feb-2021				51.30	3815.42
	2-Nov-2020				51.88	3814.84
	10-Aug-2020				52.01	3814.71
	12-May-2020				52.32	3814.40
	4-Feb-2020				51.66	3815.06
	8-Nov-2019				50.91	3815.81
	5-Aug-2019				51.71	3815.01
	8-May-2019				51.75	3814.97
	19-Feb-2019				51.65	3815.07
	13-Nov-2018				51.28	3815.44
	6-Aug-2018				50.60	3816.12
	17-May-2018				52.21	3814.51
	6-Feb-2018				51.35	3815.37
	7-Nov-2017				51.30	3815.42
	8-Aug-2017				52.10	3814.62
	15-May-2017				52.48	3814.24
	7-Feb-2017				52.63	3814.09
	7-Nov-2016				52.41	3814.31
	16-Aug-2016				52.73	3813.99
	17-May-2016				53.20	3813.52
	10-Feb-2016				52.77	3813.95
	6-Nov-2015				52.77	3813.95
	6-Aug-2015				52.87	3813.85
7-May-2015	52.75	3813.97				
6-Feb-2015	52.18	3814.54				
10-Nov-2014	51.93	3814.79				
13-Aug-2014	51.10	3815.62				
12-May-2014	51.43	3815.29				
12-Feb-2014	50.92	3815.80				
7-Nov-2013	50.49	3816.23				
7-Aug-2013	49.24	3817.48				
7-May-2013	49.66	3817.06				
8-Feb-2013	49.36	3817.36				
29-Oct-2012	48.96	3817.76				
31-Jul-2012	48.59	3818.13				
23-Apr-2011	48.44	3818.28				
25-Jan-2012	48.01	3818.71				
6-Dec-2011	48.15	3818.57				

**TABLE 1. SUMMARY OF MONITORING WELL FLUID GAUGING DATA
DONA ANA DAIRIES, DONA ANA COUNTY, NEW MEXICO**

Monitoring Well	Date Measured	Northing ^a	Easting ^a	Casing Elevation ^b	Depth to Water ^c	Ground Water Elevation ^b
DAD-13	2-Nov-2023	417879.08	1515673.13	3898.44	88.95	3809.49
	3-Aug-2023				88.67	3809.77
	2-May-2023				88.53	3809.91
	2-Feb-2023				87.60	3810.84
	4-Nov-2022				87.33	3811.11
	4-Aug-2022				88.10	3810.34
	3-May-2022				87.50	3810.94
	8-Feb-2022				86.91	3811.53
	2-Nov-2021				87.62	3810.82
	5-Aug-2021				88.50	3809.94
	4-May-2021				87.17	3811.27
	11-Feb-2021				86.29	3812.15
	3-Nov-2020				86.76	3811.68
	11-Aug-2020				87.56	3810.88
	12-May-2020				87.41	3811.03
	5-Feb-2020				86.10	3812.34
	8-Nov-2019				87.13	3811.31
	1-Aug-2019				88.64	3809.80
	8-May-2019				88.75	3809.69
	19-Feb-2019				86.29	3812.15
	12-Nov-2018				86.20	3812.24
	6-Aug-2018				89.48	3808.96
	17-May-2018				89.84	3808.60
	5-Feb-2018				85.81	3812.63
	6-Nov-2017				86.65	3811.79
	8-Aug-2017				88.68	3809.76
	15-May-2017				88.16	3810.28
	7-Feb-2017				86.25	3812.19
	8-Nov-2016				87.04	3811.40
	16-Aug-2016				87.70	3810.74
	20-May-2016				88.63	3809.81
	10-Feb-2016				86.30	3812.14
	6-Nov-2015				86.40	3812.04
	6-Aug-2015				88.65	3809.79
	7-May-2015				88.05	3810.39
	6-Feb-2015				85.50	3812.94
	10-Nov-2014				85.74	3812.70
	13-Aug-2014				86.67	3811.77
	13-May-2014				87.24	3811.20
	12-Feb-2014				84.45	3813.99
7-Nov-2013	85.43	3813.01				
14-Aug-2013	86.46	3811.98				
8-May-2013	84.96	3813.48				
8-Feb-2013	84.81	3813.63				
29-Oct-2012	85.39	3813.05				
30-Jul-2012	85.51	3812.93				
23-Apr-2012	83.56	3814.88				
25-Jan-2012	82.72	3815.72				
8-Dec-2011	82.88	3815.56				

**TABLE 1. SUMMARY OF MONITORING WELL FLUID GAUGING DATA
DONA ANA DAIRIES, DONA ANA COUNTY, NEW MEXICO**

Monitoring Well	Date Measured	Northing ^a	Easting ^a	Casing Elevation ^b	Depth to Water ^c	Ground Water Elevation ^b
DAD-14	2-Nov-2023	414923.33	1514695.26	3841.90	32.48	3809.42
	3-Aug-2023				32.06	3809.84
	2-May-2023				31.85	3810.05
	3-Feb-2023				31.52	3810.38
	2-Nov-2022				31.30	3810.60
	4-Aug-2022				30.65	3811.25
	3-May-2022				30.80	3811.10
	8-Feb-2022				30.44	3811.46
	2-Nov-2021				30.51	3811.39
	5-Aug-2021				30.22	3811.68
	4-May-2021				30.25	3811.65
	11-Feb-2021				29.31	3812.59
	3-Nov-2020				29.43	3812.47
	11-Aug-2020				29.36	3812.54
	11-May-2010				29.85	3812.05
	5-Feb-2020				29.30	3812.60
	8-Nov-2019				29.64	3812.26
	1-Aug-2019				30.10	3811.80
	8-May-2019				29.77	3812.13
	19-Feb-2019				29.24	3812.66
	12-Nov-2018				29.30	3812.60
	6-Aug-2018				29.35	3812.55
	17-May-2018				29.55	3812.35
	5-Feb-2018				28.80	3813.10
	6-Nov-2017				29.07	3812.83
	9-Aug-2017				29.75	3812.15
	15-May-2017				30.40	3811.50
	7-Feb-2017				30.00	3811.90
	8-Nov-2016				30.18	3811.72
	16-Aug-2016				30.55	3811.35
	17-May-2016				30.95	3810.95
	10-Feb-2016				30.47	3811.43
	6-Nov-2015				30.54	3811.36
	6-Aug-2015				30.47	3811.43
	7-May-2015				30.29	3811.61
	6-Feb-2015				29.83	3812.07
	10-Nov-2014				29.50	3812.40
	13-Aug-2014				28.63	3813.27
	13-May-2014				29.68	3812.22
	12-Feb-2014				29.02	3812.88
7-Nov-2013	28.44	3813.46				
7-Aug-2013	28.25	3813.65				
8-May-2013	28.15	3813.75				
8-Feb-2013	27.31	3814.59				
25-Oct-2012	26.62	3815.28				
30-Jul-2012	25.85	3816.05				
24-Apr-2012	26.07	3815.83				
25-Jan-2012	26.10	3815.80				
8-Dec-2011	26.30	3815.60				

**TABLE 1. SUMMARY OF MONITORING WELL FLUID GAUGING DATA
DONA ANA DAIRIES, DONA ANA COUNTY, NEW MEXICO**

Monitoring Well	Date Measured	Northing ^a	Easting ^a	Casing Elevation ^b	Depth to Water ^c	Ground Water Elevation ^b
DAD-15	3-Nov-2023	402001.22	1523552.04	3897.61	97.05	3800.56
	3-Aug-2023				97.11	3800.50
	3-May-2023				97.01	3800.60
	6-Feb-2023				96.80	3800.81
	3-Nov-2022				96.77	3800.84
	4-Aug-2022				96.70	3800.91
	3-May-2022				96.38	3801.23
	10-Feb-2022				96.11	3801.50
	2-Nov-2021				96.30	3801.31
	5-Aug-2021				Not Gauged - Inaccessible	
	5-May-2021				96.24	3801.37
	11-Feb-2021				95.91	3801.70
	4-Nov-2020				96.25	3801.36
	12-Aug-2020				95.73	3801.88
	12-May-2020				96.39	3801.22
	6-Feb-2020				95.22	3802.39
	25-Nov-2019				96.40	3801.21
	5-Aug-2019				96.30	3801.31
	9-May-2019				96.00	3801.61
	21-Feb-2019				95.71	3801.90
	13-Nov-2018				96.05	3801.56
	7-Aug-2018				95.74	3801.87
	17-May-2018				95.65	3801.96
	6-Feb-2018				95.62	3801.99
	7-Nov-2017				95.86	3801.75
	15-Aug-2017				96.41	3801.20
	16-May-2017				96.18	3801.43
	16-Feb-2017				95.81	3801.80
	8-Nov-2016				96.21	3801.40
	16-Aug-2016				96.38	3801.23
	17-May-2016				96.32	3801.29
	10-Feb-2016				96.00	3801.61
	6-Nov-2015				96.08	3801.53
	6-Aug-2015				96.05	3801.56
	7-May-2015				96.05	3801.56
	6-Feb-2015				95.65	3801.96
	6-Nov-2014				95.11	3802.50
	14-Aug-2014				95.50	3802.11
	13-May-2014				95.47	3802.14
	12-Feb-2014				94.81	3802.80
	7-Nov-2013				95.08	3802.53
7-Aug-2013	95.31	3802.30				
8-May-2013	94.35	3803.26				
8-Feb-2013	94.01	3803.60				
29-Oct-2012	93.78	3803.83				

**TABLE 1. SUMMARY OF MONITORING WELL FLUID GAUGING DATA
DONA ANA DAIRIES, DONA ANA COUNTY, NEW MEXICO**

Monitoring Well	Date Measured	Northing ^a	Easting ^a	Casing Elevation ^b	Depth to Water ^c	Ground Water Elevation ^b
DAD-16	3-Nov-2023	400628.77	1519350.74	3819.28	20.30	3798.98
	4-Aug-2023				20.91	3798.37
	3-May-2023				20.05	3799.23
	6-Feb-2023				19.85	3799.43
	3-Nov-2022				20.30	3798.98
	4-Aug-2022				20.02	3799.26
	4-May-2022				19.39	3799.89
	8-Feb-2022				18.65	3800.63
	3-Nov-2021				19.13	3800.15
	6-Aug-2021				20.01	3799.27
	5-May-2021				16.57	3802.71
	11-Feb-2021				17.32	3801.96
	3-Nov-2020				17.76	3801.52
	11-Aug-2020				18.04	3801.24
	12-May-2020				18.40	3800.88
	6-Feb-2020				17.25	3802.03
	8-Nov-2019				18.44	3800.84
	5-Aug-2019				19.03	3800.25
	9-May-2019				19.25	3800.03
	20-Feb-2019				17.45	3801.83
	13-Nov-2018				17.90	3801.38
	7-Aug-2018				18.00	3801.28
	17-May-2018				18.45	3800.83
	6-Feb-2018				16.39	3802.89
	7-Nov-2017				16.26	3803.02
	9-Aug-2017				16.60	3802.68
	16-May-2017				19.34	3799.94
	7-Feb-2017				17.16	3802.12
	8-Nov-2016				17.73	3801.55
	16-Aug-2016				17.70	3801.58
	17-May-2016				20.22	3799.06
	10-Feb-2016				18.46	3800.82
	6-Nov-2015				19.24	3800.04
	6-Aug-2015				19.46	3799.82
	7-May-2015				20.45	3798.83
	6-Feb-2015				18.45	3800.83
	10-Nov-2014				18.94	3800.34
	13-Aug-2014				19.45	3799.83
	13-May-2014				20.31	3798.97
	13-Feb-2014				18.45	3800.83
7-Nov-2013	18.94	3800.34				
7-Aug-2013	19.06	3800.22				
8-May-2013	18.49	3800.79				
8-Feb-2013	17.20	3802.08				
29-Oct-2012	17.23	3802.05				
31-Jul-2012	18.58	3800.70				
24-Apr-2012	17.64	3801.64				
25-Jan-2012	16.50	3802.78				
8-Dec-2011	16.58	3802.70				

**TABLE 1. SUMMARY OF MONITORING WELL FLUID GAUGING DATA
DONA ANA DAIRIES, DONA ANA COUNTY, NEW MEXICO**

Monitoring Well	Date Measured	Northing ^a	Easting ^a	Casing Elevation ^b	Depth to Water ^c	Ground Water Elevation ^b
DAD-17	3-Nov-2023	393991.97	1520267.94	3817.75	21.46	3796.29
	4-Aug-2023				20.73	3797.02
	4-May-2023				21.66	3796.09
	7-Feb-2023				20.79	3796.96
	4-Nov-2022				21.27	3796.48
	5-Aug-2022				21.69	3796.06
	4-May-2022				20.87	3796.88
	9-Feb-2022				20.02	3797.73
	3-Nov-2021				20.26	3797.49
	6-Aug-2021				20.99	3796.76
	5-May-2021				19.91	3797.84
	12-Feb-2021				19.05	3798.70
	4-Nov-2020				19.00	3798.75
	12-Aug-2020				19.03	3798.72
	12-May-2020				19.97	3797.78
	6-Feb-2020				18.87	3798.88
	8-Nov-2019				18.18	3799.57
	2-Aug-2019				19.31	3798.44
	9-May-2019				20.17	3797.58
	19-Feb-2019				19.20	3798.55
	13-Nov-2018				19.35	3798.40
	7-Aug-2018				18.72	3799.03
	14-May-2018				21.04	3796.71
	6-Feb-2018				18.61	3799.14
	7-Nov-2017				18.41	3799.34
	9-Aug-2017				18.07	3799.68
	16-May-2017				20.56	3797.19
	7-Feb-2017				19.47	3798.28
	8-Nov-2016				20.18	3797.57
	16-Aug-2016				20.17	3797.58
	17-May-2016				22.97	3794.78
	10-Feb-2016				21.22	3796.53
	6-Nov-2015				22.95	3794.80
	13-Aug-2015				21.95	3795.80
	7-May-2015				22.59	3795.16
	6-Feb-2015				21.00	3796.75
	10-Nov-2014				21.76	3795.99
	13-Aug-2014				20.32	3797.43
	13-May-2014				23.32	3794.43
	12-Feb-2014				20.05	3797.70
7-Nov-2013	20.21	3797.54				
7-Aug-2013	19.75	3798.00				
13-May-2013	19.37	3798.38				
8-Feb-2013	18.55	3799.20				
29-Oct-2012	19.18	3798.57				
2-Aug-2012	19.07	3798.68				
24-Apr-2012	21.01	3796.74				
25-Jan-2012	17.74	3800.01				
9-Dec-2011	19.21	3798.54				

**TABLE 1. SUMMARY OF MONITORING WELL FLUID GAUGING DATA
DONA ANA DAIRIES, DONA ANA COUNTY, NEW MEXICO**

Monitoring Well	Date Measured	Northing ^a	Easting ^a	Casing Elevation ^b	Depth to Water ^c	Ground Water Elevation ^b
DAD-18 Vertical Delineation	3-Nov-2023	395714.14	1520588.96	3821.59	24.70	3796.89
	4-Aug-2023				23.80	3797.79
	4-May-2023				24.55	3797.04
	7-Feb-2023				23.91	3797.68
	4-Nov-2022				24.48	3797.11
	5-Aug-2022				23.86	3797.73
	4-May-2022				24.18	3797.41
	9-Feb-2022				23.41	3798.18
	3-Nov-2021				24.06	3797.53
	6-Aug-2021				23.70	3797.89
	5-May-2021				23.11	3798.48
	12-Feb-2021				22.02	3799.57
	4-Nov-2020				21.24	3800.35
	12-Aug-2020				20.65	3800.94
	12-May-2020				21.28	3800.31
	6-Feb-2020				20.19	3801.40
	8-Nov-2019				20.00	3801.59
	2-Aug-2019				21.26	3800.33
	9-May-2019				23.49	3798.10
	20-Feb-2019				22.24	3799.35
	13-Nov-2018				22.43	3799.16
	7-Aug-2018				21.95	3799.64
	14-May-2018				23.58	3798.01
	6-Feb-2018				22.00	3799.59
	7-Nov-2017				22.41	3799.18
	7-Aug-2017				21.97	3799.62
	16-May-2017				24.19	3797.40
	7-Feb-2017				23.25	3798.34
	8-Nov-2016				23.55	3798.04
	16-Aug-2016				22.10	3799.49
	17-May-2016				25.39	3796.20
	10-Feb-2016				23.81	3797.78
	6-Nov-2015				24.35	3797.24
	13-Aug-2015				23.37	3798.22
7-May-2015	25.84	3795.75				
6-Feb-2015	23.73	3797.86				
10-Nov-2014	24.90	3796.69				
12-Aug-2014	22.93	3798.66				
13-May-2014	25.33	3796.26				
17-Feb-2014	23.03	3798.56				
7-Nov-2013	23.25	3798.34				
7-Aug-2013	24.23	3797.36				
13-May-2013	22.97	3798.62				
8-Feb-2013	22.04	3799.55				
29-Oct-2012	22.40	3799.19				
1-Aug-2012	22.43	3799.16				
24-Apr-2012	22.20	3799.39				
25-Jan-2012	21.33	3800.26				
6-Dec-2011	21.43	3800.16				

**TABLE 1. SUMMARY OF MONITORING WELL FLUID GAUGING DATA
DONA ANA DAIRIES, DONA ANA COUNTY, NEW MEXICO**

Monitoring Well	Date Measured	Northing ^a	Easting ^a	Casing Elevation ^b	Depth to Water ^c	Ground Water Elevation ^b
DAD-19 Vertical Delineation	3-Nov-2023	400164.47	1522027.92	3864.50	66.12	3798.38
	4-Aug-2023				66.37	3798.13
	4-May-2023				66.28	3798.22
	7-Feb-2023				65.40	3799.10
	4-Nov-2022				65.64	3798.86
	5-Aug-2022				65.41	3799.09
	4-May-2022				64.58	3799.92
	9-Feb-2022				63.66	3800.84
	3-Nov-2021				64.50	3800.00
	6-Aug-2021				64.90	3799.60
	5-May-2021				64.38	3800.12
	12-Feb-2021				63.43	3801.07
	4-Nov-2020				63.62	3800.88
	11-Aug-2020				63.89	3800.61
	12-May-2020				64.57	3799.93
	6-Feb-2020				63.98	3800.52
	7-Nov-2019				64.59	3799.91
	2-Aug-2019				64.79	3799.71
	9-May-2019				64.35	3800.15
	20-Feb-2019				63.40	3801.10
	13-Nov-2018				64.06	3800.44
	7-Aug-2018				63.95	3800.55
	14-May-2018				63.38	3801.12
	6-Feb-2018				62.67	3801.83
	7-Nov-2017				62.88	3801.62
	9-Aug-2017				63.71	3800.79
	16-May-2017				64.53	3799.97
	7-Feb-2017				63.57	3800.93
	8-Nov-2016				64.00	3800.50
	16-Aug-2016				64.54	3799.96
	17-May-2016				64.73	3799.77
	10-Feb-2016				64.50	3800.00
	6-Nov-2015				64.78	3799.72
	6-Aug-2015				65.35	3799.15
	7-May-2015				65.56	3798.94
	6-Feb-2015				64.38	3800.12
10-Nov-2014	64.50	3800.00				
12-Aug-2014	65.29	3799.21				
13-May-2014	65.26	3799.24				
12-Feb-2014	63.99	3800.51				
7-Nov-2013	64.11	3800.39				
7-Aug-2013	64.46	3800.04				
14-May-2013	63.75	3800.75				
8-Feb-2013	62.95	3801.55				
29-Oct-2012	62.30	3802.20				
1-Aug-2012	63.70	3800.80				
24-Apr-2012	63.31	3801.19				
25-Jan-2012	62.25	3802.25				
6-Dec-2011	62.29	3802.21				

**TABLE 1. SUMMARY OF MONITORING WELL FLUID GAUGING DATA
DONA ANA DAIRIES, DONA ANA COUNTY, NEW MEXICO**

Monitoring Well	Date Measured	Northing ^a	Easting ^a	Casing Elevation ^b	Depth to Water ^c	Ground Water Elevation ^b
DAD-20	6-Nov-2023	371751.45	1531188.19	3833.27	58.41	3774.86
	7-Aug-2023				57.18	3776.09
	4-May-2023				57.59	3775.68
	7-Feb-2023				57.06	3776.21
	4-Nov-2022				57.39	3775.88
	5-Aug-2022				57.22	3776.05
	4-May-2022				56.81	3776.46
	10-Feb-2022				56.20	3777.07
	3-Nov-2021				56.68	3776.59
	6-Aug-2021				56.51	3776.76
	5-May-2021				56.08	3777.19
	12-Feb-2021				55.47	3777.80
	4-Nov-2020				55.60	3777.67
	12-Aug-2020				55.26	3778.01
	12-May-2020				54.88	3778.39
	6-Feb-2020				53.54	3779.73
	7-Nov-2019				53.55	3779.72
	5-Aug-2019				54.55	3778.72
	9-May-2019				54.98	3778.29
	20-Feb-2019				54.60	3778.67
	13-Nov-2018				54.60	3778.67
	7-Aug-2018				54.80	3778.47
	14-May-2018				54.96	3778.31
	6-Feb-2018				54.27	3779.00
	6-Nov-2017				54.41	3778.86
	9-Aug-2017				54.71	3778.56
	16-May-2017				55.10	3778.17
	16-Feb-2017				54.55	3778.72
	8-Nov-2016				54.84	3778.43
	16-Aug-2016				54.97	3778.30
	17-May-2016				54.94	3778.33
	10-Feb-2016				54.50	3778.77
	6-Nov-2015				54.41	3778.86
	6-Aug-2015				54.32	3778.95
	7-May-2015				54.40	3778.87
	6-Feb-2015				54.26	3779.01
	6-Nov-2014				54.44	3778.83
	12-Aug-2014				54.26	3779.01
	13-May-2014				54.20	3779.07
	13-Feb-2014				53.54	3779.73
	7-Nov-2013				53.70	3779.57
7-Aug-2013	53.43	3779.84				
8-May-2013	52.88	3780.39				
8-Feb-2013	52.29	3780.98				
7-Nov-2012	52.18	3781.09				
29-Oct-2012	Obstruction in Well					
2-Aug-2012	Obstruction in Well					
25-Apr-2012	Obstruction in Well					
25-Jan-2012	50.65	3782.62				
6-Dec-2011	50.66	3782.61				

**TABLE 1. SUMMARY OF MONITORING WELL FLUID GAUGING DATA
DONA ANA DAIRIES, DONA ANA COUNTY, NEW MEXICO**

Monitoring Well	Date Measured	Northing ^a	Easting ^a	Casing Elevation ^b	Depth to Water ^c	Ground Water Elevation ^b
DAD-21	6-Nov-2023	374013.39	1530983.98	3839.62	58.88	3780.74
	7-Aug-2023				58.70	3780.92
	4-May-2023				58.40	3781.22
	7-Feb-2023				58.02	3781.60
	4-Nov-2022				57.21	3782.41
	5-Aug-2022				56.51	3783.11
	4-May-2022				55.70	3783.92
	10-Feb-2022				54.81	3784.81
	3-Nov-2021				55.25	3784.37
	6-Aug-2021				56.12	3783.50
	5-May-2021				55.97	3783.65
	12-Feb-2021				55.90	3783.72
	4-Nov-2020				56.12	3783.50
	12-Aug-2020				56.25	3783.37
	12-May-2020				56.33	3783.29
	6-Feb-2020				57.02	3782.60
	8-Nov-2019				56.12	3783.50
	2-Aug-2019				57.76	3781.86
	9-May-2019				57.58	3782.04
	20-Feb-2019				58.62	3781.00
	13-Nov-2018				58.85	3780.77
	7-Aug-2018				58.79	3780.83
	17-May-2018				58.82	3780.80
	6-Feb-2018				58.65	3780.97
	6-Nov-2017				58.61	3781.01
	9-Aug-2017				59.28	3780.34
	16-May-2017				59.13	3780.49
	7-Feb-2017				59.02	3780.60
	8-Nov-2016				58.95	3780.67
	16-Aug-2016				58.79	3780.83
	17-May-2016				58.54	3781.08
	10-Feb-2016				58.48	3781.14
	6-Nov-2015				58.13	3781.49
	6-Aug-2015				57.83	3781.79
	7-May-2015				57.56	3782.06
	6-Feb-2015				57.16	3782.46
	6-Nov-2014				56.97	3782.65
	12-Aug-2014				56.82	3782.80
	13-May-2014				56.42	3783.20
	17-Feb-2014				55.97	3783.65
7-Nov-2013	55.89	3783.73				
7-Aug-2013	55.81	3783.81				
7-May-2013	55.43	3784.19				
8-Feb-2013	55.10	3784.52				
29-Oct-2012	54.60	3785.02				
2-Aug-2012	54.31	3785.31				
24-Apr-2012	53.61	3786.01				
30-Jan-2012	53.44	3786.18				
6-Dec-2011	53.24	3786.38				

**TABLE 1. SUMMARY OF MONITORING WELL FLUID GAUGING DATA
DONA ANA DAIRIES, DONA ANA COUNTY, NEW MEXICO**

Monitoring Well	Date Measured	Northing ^a	Easting ^a	Casing Elevation ^b	Depth to Water ^c	Ground Water Elevation ^b
DAD-22	6-Nov-2023	373029.62	1530352.69	3827.14	46.91	3780.23
	7-Aug-2023				46.90	3780.24
	4-May-2023				47.00	3780.14
	7-Feb-2023				47.05	3780.09
	4-Nov-2022				47.31	3779.83
	5-Aug-2022				47.15	3779.99
	4-May-2022				46.70	3780.44
	10-Feb-2022				46.22	3780.92
	3-Nov-2021				46.53	3780.61
	6-Aug-2021				46.76	3780.38
	5-May-2021				46.46	3780.68
	12-Feb-2021				46.79	3780.35
	4-Nov-2020				47.33	3779.81
	12-Aug-2020				46.72	3780.42
	12-May-2020				46.62	3780.52
	6-Feb-2020				46.29	3780.85
	8-Nov-2019				46.03	3781.11
	2-Aug-2019				47.00	3780.14
	9-May-2019				47.33	3779.81
	20-Feb-2019				47.31	3779.83
	13-Nov-2018				47.30	3779.84
	7-Aug-2018				47.81	3779.33
	17-May-2018				47.77	3779.37
	6-Feb-2018				47.80	3779.34
	7-Nov-2017				48.11	3779.03
	9-Aug-2017				48.62	3778.52
	16-May-2017				48.57	3778.57
	7-Feb-2017				48.20	3778.94
	8-Nov-2016				48.30	3778.84
	16-Aug-2016				48.17	3778.97
	17-May-2016				47.91	3779.23
	10-Feb-2016				47.57	3779.57
	6-Nov-2015				47.64	3779.50
	6-Aug-2015				47.65	3779.49
	7-May-2015				47.54	3779.60
	6-Feb-2015				47.30	3779.84
	6-Nov-2014				47.14	3780.00
	12-Aug-2014				46.98	3780.16
	13-May-2014				46.56	3780.58
	17-Feb-2014				46.18	3780.96
7-Nov-2013	45.73	3781.41				
7-Aug-2013	45.77	3781.37				
14-May-2013	44.09	3783.05				
8-Feb-2013	44.08	3783.06				
29-Oct-2012	44.51	3782.63				
2-Aug-2012	44.23	3782.91				
25-Apr-2012	43.86	3783.28				
25-Jan-2012	43.22	3783.92				
13-Dec-2011	43.27	3783.87				

**TABLE 1. SUMMARY OF MONITORING WELL FLUID GAUGING DATA
DONA ANA DAIRIES, DONA ANA COUNTY, NEW MEXICO**

Monitoring Well	Date Measured	Northing ^a	Easting ^a	Casing Elevation ^b	Depth to Water ^c	Ground Water Elevation ^b
DAD-23	3-Nov-2023	413958.29	1515697.17	3855.46	46.93	3808.53
	3-Aug-2023				46.80	3808.66
	3-May-2023				46.46	3809.00
	3-Feb-2023				45.88	3809.58
	3-Nov-2022				46.00	3809.46
	4-Aug-2022				45.62	3809.84
	3-May-2022				45.30	3810.16
	8-Feb-2022				44.80	3810.66
	2-Nov-2021				45.08	3810.38
	5-Aug-2021				44.81	3810.65
	4-May-2021				44.70	3810.76
	11-Feb-2021				43.75	3811.71
	3-Nov-2020				44.15	3811.31
	11-Aug-2020				44.61	3810.85
	12-May-2020				44.45	3811.01
	5-Feb-2020				43.86	3811.60
	8-Nov-2019				43.33	3812.13
	1-Aug-2019				44.85	3810.61
	8-May-2019				44.23	3811.23
	19-Feb-2019				43.75	3811.71
	12-Nov-2018				43.94	3811.52
	6-Aug-2018				44.18	3811.28
	17-May-2018				44.00	3811.46
	6-Feb-2018				43.24	3812.22
	6-Nov-2017				43.72	3811.74
	9-Aug-2017				44.55	3810.91
	16-May-2017				44.84	3810.62
	7-Feb-2017				44.32	3811.14
	8-Nov-2016				44.85	3810.61
	17-Aug-2016				45.38	3810.08
17-May-2016	45.52	3809.94				
11-Feb-2016	45.37	3810.09				

**TABLE 1. SUMMARY OF MONITORING WELL FLUID GAUGING DATA
DONA ANA DAIRIES, DONA ANA COUNTY, NEW MEXICO**

Monitoring Well	Date Measured	Northing ^a	Easting ^a	Casing Elevation ^b	Depth to Water ^c	Ground Water Elevation ^b
DAD-24 Vertical Delineation	3-Nov-2023	400183.23	1522052.57	3864.91	67.86	3797.05
	4-Aug-2023				68.66	3796.25
	4-May-2023				67.71	3797.20
	7-Feb-2023				66.80	3798.11
	4-Nov-2022				67.50	3797.41
	5-Aug-2022				68.68	3796.23
	4-May-2022				67.77	3797.14
	9-Feb-2022				66.86	3798.05
	3-Nov-2021				67.68	3797.23
	6-Aug-2021				68.00	3796.91
	5-May-2021				67.20	3797.71
	12-Feb-2021				66.60	3798.31
	4-Nov-2020				66.92	3797.99
	11-Aug-2020				67.28	3797.63
	12-May-2020				67.66	3797.25
	6-Feb-2020				67.10	3797.81
	7-Nov-2019				68.27	3796.64
	2-Aug-2019				67.44	3797.47
	9-May-2019				67.45	3797.46
	20-Feb-2019				64.52	3800.39
	13-Nov-2018				64.92	3799.99
	7-Aug-2018				66.86	3798.05
	14-May-2018				66.88	3798.03
	6-Feb-2018				64.40	3800.51
	7-Nov-2017				64.70	3800.21
	9-Aug-2017				64.75	3800.16
16-May-2017	66.80	3798.11				
7-Feb-2017	66.04	3798.87				
8-Nov-2016	65.95	3798.96				
16-Aug-2016	65.60	3799.31				
17-May-2016	67.91	3797.00				
11-Feb-2016	67.85	3797.06				
DAD-25	3-Nov-2023	394560.83	1524599.12	3870.63	67.88	3802.75
	4-Aug-2023				67.70	3802.93
	4-May-2023				67.52	3803.11
	7-Feb-2023				67.32	3803.31
	4-Nov-2022				67.09	3803.54
	5-Aug-2022				66.97	3803.66
	4-May-2022				66.73	3803.90
	9-Feb-2022				67.55	3803.08
	3-Nov-2021				68.01	3802.62
	6-Aug-2021				68.70	3801.93
	5-May-2021				69.09	3801.54
	12-Feb-2021				68.38	3802.25
	4-Nov-2020				68.29	3802.34
	12-Aug-2020				67.66	3802.97
	12-May-2020				68.17	3802.46
	6-Feb-2020				67.03	3803.60
	8-Nov-2019				66.11	3804.52
	2-Aug-2019				67.81	3802.82
	9-May-2019				67.73	3802.90
	20-Feb-2019				67.65	3802.98
	13-Nov-2018				67.49	3803.14
	7-Aug-2018				67.20	3803.43
	14-May-2018				66.90	3803.73
	6-Feb-2018				66.49	3804.14
	7-Nov-2017				64.82	3805.81
	9-Aug-2017				65.00	3805.63
16-May-2017	66.21	3804.42				
7-Feb-2017	65.72	3804.91				
8-Nov-2016	65.31	3805.32				
16-Aug-2016	64.84	3805.79				
17-May-2016	64.55	3806.08				
11-Feb-2016	64.11	3806.52				

**TABLE 1. SUMMARY OF MONITORING WELL FLUID GAUGING DATA
DONA ANA DAIRIES, DONA ANA COUNTY, NEW MEXICO**

Monitoring Well	Date Measured	Northing ^a	Easting ^a	Casing Elevation ^b	Depth to Water ^c	Ground Water Elevation ^b
DAD-26	6-Nov-2023	372513.58	1530789.76	3829.31	49.40	3779.91
	7-Aug-2023				49.45	3779.86
	4-May-2023				49.84	3779.47
	7-Feb-2023				49.73	3779.58
	4-Nov-2022				50.29	3779.02
	5-Aug-2022				50.20	3779.11
	4-May-2022				49.79	3779.52
	10-Feb-2022				49.30	3780.01
	3-Nov-2021				49.75	3779.56
	6-Aug-2021				49.51	3779.80
	5-May-2021				49.35	3779.96
	12-Feb-2021				49.25	3780.06
	4-Nov-2020				49.50	3779.81
	12-Aug-2020				49.40	3779.91
	12-May-2020				49.00	3780.31
	6-Feb-2020				48.00	3781.31
	8-Nov-2019				47.83	3781.48
	2-Aug-2019				48.45	3780.86
	9-May-2019				49.18	3780.13
	20-Feb-2019				50.12	3779.19
	13-Nov-2018				50.66	3778.65
	7-Aug-2018				50.75	3778.56
	17-May-2018				50.69	3778.62
	6-Feb-2018				50.35	3778.96
	6-Nov-2017				50.66	3778.65
	9-Aug-2017				51.10	3778.21
16-May-2017	51.11	3778.20				
7-Feb-2017	50.70	3778.61				
8-Nov-2016	51.07	3778.24				
17-Aug-2016	50.97	3778.34				
17-May-2016	50.55	3778.76				
11-Feb-2016	50.30	3779.01				
DAD-27	6-Nov-2023	371781.16	1528921.96	3804.23	27.79	3776.44
	7-Aug-2023				26.98	3777.25
	4-May-2023				27.70	3776.53
	8-Feb-2023				27.10	3777.13

Notes:

^a Horizontal control to NM State Plane Coordinates Central NAD83 Grid Coordinates (in feet)

^b Vertical Control to NAVD88 Datum in feet above mean sea level

^c Measured in feet below the top of casing at survey point on north side of well

^d Measured in feet

Gauging data from current quarter.

Wells were gauged on a different date by Magee and Associates Inc.

Wells were gauged on a different date by EnviroCompliance Inc.

Groundwater elevation is anomalous.

Measured data were suspect and corrected to reflect appropriate trends in accordance with surrounding wells

**TABLE 2. SUMMARY OF MONITORING WELL GROUNDWATER FIELD PARAMETERS
DONA ANA DAIRIES, DONA ANA COUNTY, NEW MEXICO**

Monitoring Well	Date Measured	pH	SpC (uS/cm)	Temp (°C)	DO (mg/L)	ORP (mV)
NORTHERN AREA						
Northern Land Application Area						
70-03	9-Nov-2023	7.28	7,011	21.2	1.55	169
	9-Aug-2023	7.18	6,984	22.7	2.05	145
	8-May-2023	7.20	7,133	20.7	1.08	156
	9-Feb-2023	7.23	6,941	20.0	2.88	176
	8-Nov-2022	7.26	7,208	21.7	2.08	163
	9-Aug-2022	7.30	7,265	22.4	2.69	168
	9-May-2022	7.19	6,729	22.1	2.35	149
	15-Feb-2022	7.20	6,560	20.6	2.91	159
	5-Nov-2021	7.24	6,943	21.3	2.70	269
	10-Aug-2021	7.61	7,280	21.9	2.38	54
	10-May-2021	7.18	7,423	21.4	2.09	191
	16-Feb-2021	7.36	7,008	19.5	1.81	126
	11-Nov-2020	7.38	7,493	20.8	2.38	100
	14-Aug-2020	7.43	8,430	22.6	2.20	145
	13-May-2020	7.42	9,512	22.6	2.33	104
	7-Feb-2020	7.66	8,733	20.4	8.37	64
	15-Nov-2019	6.52	9,236	20.7	2.08	131
	6-Aug-2019	6.86	10,460	21.7	NM	162
	16-May-2019	7.25	10,470	21.9	4.22	35
	26-Feb-2019	6.57	6,164	20.7	1.29	176
	15-Nov-2018	6.68	11,020	19.8	1.74	180
	15-Aug-2018	7.08	11,530	22.6	1.34	140
	21-May-2018	6.58	11,570	21.30	NM	110
	13-Feb-2018	7.11	11,890	20.30	2.12	147
	9-Nov-2017	6.71	11,700	18.90	3.07	135
	14-Aug-2017	7.09	12,340	21.70	4.50	37
	19-May-2017	6.91	11,880	20.76	2.61	226.7
	20-Feb-2017	7.54	10,832	20.68	3.78	181.6
	22-Nov-2016	7.12	11,539	20.12	3.93	95.5
	18-Aug-2016	6.92	11,818	21.34	2.26	29.4
24-May-2016	6.95	10,486	20.41	2.90	46.2	
16-Feb-2016	6.50	9,366	19.76	3.00	253.4	
12-Nov-2015	7.16	9,359	20.21	1.32	206.1	
19-Aug-2015	6.96	11,433	25.28	NM	209.7	

**TABLE 2. SUMMARY OF MONITORING WELL GROUNDWATER FIELD PARAMETERS
DONA ANA DAIRIES, DONA ANA COUNTY, NEW MEXICO**

Monitoring Well	Date Measured	pH	SpC (uS/cm)	Temp (°C)	DO (mg/L)	ORP (mV)
70/86/340-01	8-Nov-2023	7.23	9,068	20.9	1.55	207
	8-Aug-2023	7.19	1,777	22.0	1.31	69
	5-May-2023	7.27	9,163	20.6	2.73	141
	8-Feb-2023	7.20	9,515	19.1	1.15	166
	7-Nov-2022	7.24	9,436	20.50	1.77	129
	8-Aug-2022	7.18	8,843	21.8	2.75	174
	5-May-2022	7.19	8,781	20.4	2.90	156
	14-Feb-2022	7.17	7,999	19.0	2.80	152
	4-Nov-2021	7.20	5,509	19.7	2.93	286
	9-Aug-2021	7.75	4,712	21.4	2.91	89
	6-May-2021	7.47	5,732	21.6	2.48	183
	15-Feb-2021	7.63	7,190	18.9	2.90	76
	11-Nov-2020	7.26	6,479	19.6	1.39	134
	13-Aug-2020	7.40	6,967	22.0	2.03	158
	18-May-2020	7.48	6,891	21.9	2.42	153
	7-Feb-2020	7.63	6,896	20.3	13.97	58
	15-Nov-2019	6.54	6,880	20.3	0.78	192
	7-Aug-2019	6.95	7,219	20.9	NM	145
	16-May-2019	7.73	7,135	21.4	2.81	72
	25-Feb-2019	7.17	5,654	20.3	2.07	143
	16-Nov-2018	6.97	6,977	19.7	2.94	165
	14-Aug-2018	7.16	7,121	22.2	3.17	125
	21-May-2018	6.66	7,060	21.40	3.51	109
	12-Feb-2018	7.21	7,190	18.80	4.19	129
	9-Nov-2017	6.93	6,928	18.50	3.12	121
	11-Aug-2017	7.25	7,974	25.00	3.57	143
	18-May-2017	6.94	7,521	20.20	2.12	183.5
	16-Feb-2017	7.27	6,420	20.36	6.36	226.7
	10-Nov-2016	7.17	7,573	20.99	3.88	133.6
	23-Aug-2016	6.90	7,584	20.69	1.24	34.1
19-May-2016	7.09	6,422	20.36	2.88	78.0	
15-Feb-2016	6.07	6,451	18.64	3.83	223.4	
10-Nov-2015	7.21	6,827	18.52	1.91	174.5	
20-Aug-2015	6.90	6,824	21.36	NM	277.1	

**TABLE 2. SUMMARY OF MONITORING WELL GROUNDWATER FIELD PARAMETERS
DONA ANA DAIRIES, DONA ANA COUNTY, NEW MEXICO**

Monitoring Well	Date Measured	pH	SpC (uS/cm)	Temp (°C)	DO (mg/L)	ORP (mV)
86/340-01	8-Nov-2023	7.20	3,301	21.0	2.42	174
	8-Aug-2023	7.29	3,288	21.2	2.61	91
	5-May-2023	7.28	3,221	20.1	2.46	125
	8-Feb-2023	7.24	3,260	18.9	2.46	162
	7-Nov-2022	7.27	3,174	20.7	2.39	142.0
	8-Aug-2022	7.19	3,135	20.9	2.36	168
	5-May-2022	7.17	3,065	19.7	2.31	139
	14-Feb-2022	7.55	3,157	18.8	2.37	142
	4-Nov-2021	7.24	3,214	19.1	2.55	264
	9-Aug-2021	7.70	3,112	21.9	2.31	170
	6-May-2021	7.21	3,065	21.9	2.29	155
	15-Feb-2021	7.19	2,982	17.4	2.31	95
	11-Nov-2020	7.13	2,958	19.3	2.38	217
	13-Aug-2020	7.60	2,955	21.6	1.95	166
	18-May-2020	7.46	2,987	21.4	2.27	265
	7-Feb-2020	7.75	2,732	18.6	7.27	42
	15-Nov-2019	6.87	2,788	18.9	1.54	318
	7-Aug-2019	7.41	3,016	20.7	NM	197
	16-May-2019	7.68	2,775	20.5	3.09	97
	25-Feb-2019	6.68	2,769	18.8	2.63	153
	16-Nov-2018	7.13	2,828	18.9	2.35	161
	14-Aug-2018	7.01	2,692	22.2	2.74	162
	21-May-2018	7.16	2,782	20.10	2.29	79
	12-Feb-2018	7.54	2,829	19.30	2.54	128
	9-Nov-2017	7.64	2,929	18.20	2.23	86
	11-Aug-2017	7.59	3,064	21.60	4.01	173
	18-May-2017	7.36	3,341	20.17	4.31	235.5
	16-Feb-2017	7.50	3,143	20.23	11.17	344.6
	10-Nov-2016	7.39	3,080	19.78	1.81	158.2
	22-Aug-2016	7.31	3,150	20.35	1.84	29.6
19-May-2016	7.41	2,925	20.15	1.97	71.4	
15-Feb-2016	5.16	2,992	19.24	1.84	237.2	
10-Nov-2015	7.55	2,951	17.52	1.74	153.4	
20-Aug-2015	7.29	2,970	20.60	NM	267.0	

**TABLE 2. SUMMARY OF MONITORING WELL GROUNDWATER FIELD PARAMETERS
DONA ANA DAIRIES, DONA ANA COUNTY, NEW MEXICO**

Monitoring Well	Date Measured	pH	SpC (uS/cm)	Temp (°C)	DO (mg/L)	ORP (mV)
Organ Dairy (Formerly known as Del Norte Dairy and Daybreak Dairy)						
126-04	20-Nov-2023	Insufficient Water-Parameters Not Collected				
	27-Aug-2023					
	24-May-2023					
	11-Jan-2023					
	8-Nov-2022					
	17-Aug-2022					
	5-May-2022					
	24-Feb-2022	7.35	4,680	18.9	2.7	207
	9-Nov-2021	7.32	4,700	18.9	2.6	185
	11-Aug-2021	7.22	2,930	23.9	3.5	252
	4-May-2021	7.25	4,240	20.1	3.4	304
	9-Feb-2021	7.30	4,180	20.4	3.7	222
	10-Nov-2020	7.13	4,580	20.3	NM	NM
	12-Aug-2020	6.99	4,530	21.4	NM	NM
	13-May-2020	7.60	3,968	23.5	1.99	121
	10-Feb-2020	7.26	3,860	20.2	10.17	75
	12-Nov-2019	6.89	3,731	20.5	3.04	138
	5-Aug-2019	7.09	3,799	22.7	NM	195
	14-May-2019	6.84	3,648	21.8	1.39	144
	22-Feb-2019	7.19	3,631	21.6	1.79	154
	14-Nov-2018	6.80	3,841	20.6	2.61	136
	15-Aug-2018	7.44	3,602	22.1	2.35	78
	18-May-2018	6.91	3,685	21.10	2.88	68
	9-Feb-2018	7.56	3,808	21.60	3.11	136
	8-Nov-2017	7.29	3,959	21.30	3.54	214
	10-Aug-2017	7.20	3,730	24.20	5.93	179
	17-May-2017	7.08	3,613	21.33	3.82	147.9
	17-Feb-2017	7.18	3,864	20.85	4.48	203.1
	9-Nov-2016	7.46	3,697	21.17	5.25	60.9
	17-Aug-2016	7.42	3,893	24.18	5.51	25.0
18-May-2016	7.04	3,371	21.24	3.27	76.2	
15-Feb-2016	5.37	3,470	21.39	3.54	201.4	
9-Nov-2015	7.11	3,558	21.29	2.40	38.5	
17-Aug-2015	6.84	3,626	22.52	NM	277.8	

**TABLE 2. SUMMARY OF MONITORING WELL GROUNDWATER FIELD PARAMETERS
DONA ANA DAIRIES, DONA ANA COUNTY, NEW MEXICO**

Monitoring Well	Date Measured	pH	SpC (uS/cm)	Temp (°C)	DO (mg/L)	ORP (mV)
126-05	20-Nov-2023	Insufficient Water-Parameters Not Collected				
	27-Aug-2023					
	24-May-2023					
	11-Jan-2023					
	8-Nov-2022					
	17-Aug-2022					
	5-May-2022					
	24-Feb-2022	7.60	5,020	17.6	3.4	130
	9-Nov-2021	7.65	4,990	21.3	3.0	220
	11-Aug-2021	Insufficient Water-Parameters Not Collected				
	4-May-2021	7.49	5,060	21.3	3.5	262
	9-Feb-2021	7.44	5,320	20.3	3.2	260
	10-Nov-2020	7.41	5,880	20.0	NM	NM
	12-Aug-2020	Insufficient Water-Parameters Not Collected				
	13-May-2020	7.67	5,430	23.7	2.19	99
	10-Feb-2020	7.40	5,362	20.3	4.99	83
	12-Nov-2019	6.84	5,678	19.2	2.88	119
	5-Aug-2019	7.12	5,341	23.2	NM	185
	14-May-2019	7.66	5,250	21.2	1.70	79
	22-Feb-2019	7.41	5,677	20.5	1.51	150
	14-Nov-2018	7.05	5,925	19.9	1.29	140
	15-Aug-2018	7.78	5,495	22.3	1.44	108
	18-May-2018	7.04	5,785	21.20	1.17	107
	9-Feb-2018	7.38	5,767	21.70	1.12	60.0
	8-Nov-2017	7.69	5,571	21.00	1.27	154.0
	10-Aug-2017	7.36	5,397	25.50	3.91	156.0
	17-May-2017	7.43	5,384	22.69	3.03	162.5
	17-Feb-2017	7.42	5,274	19.48	5.78	218.3
	9-Nov-2016	7.66	4,974	21.23	2.52	40.0
	17-Aug-2016	7.56	4,761	23.55	2.86	-78.3
	18-May-2016	7.23	4,409	20.60	3.35	73.7
15-Feb-2016	6.41	4,654	21.64	4.57	165.0	
9-Nov-2015	7.39	4,174	19.96	2.15	186.6	
17-Aug-2015	Insufficient Water-Parameters Not Collected					

**TABLE 2. SUMMARY OF MONITORING WELL GROUNDWATER FIELD PARAMETERS
DONA ANA DAIRIES, DONA ANA COUNTY, NEW MEXICO**

Monitoring Well	Date Measured	pH	SpC (uS/cm)	Temp (°C)	DO (mg/L)	ORP (mV)
126-07	20-Nov-2023	Insufficient Water-Parameters Not Collected				
	27-Aug-2023					
	24-May-2023					
	11-Jan-2023					
	8-Nov-2022					
	17-Aug-2022					
	5-May-2022					
	24-Feb-2022	7.29	5,200	17.5	3.1	158
	9-Nov-2021	7.22	5,080	23.5	2.3	229
	11-Aug-2021	7.33	4,780	21.7	3.1	233
	4-May-2021	7.02	4,840	20.6	3.0	296
	9-Feb-2021	6.95	4,830	21.1	3.3	287
	10-Nov-2020	7.00	4,920	20.4	NM	NM
	12-Aug-2020	6.77	5,000	23.1	NM	NM
	13-May-2020	7.39	4,896	23.5	1.96	133
	7-Feb-2020	6.67	4,455	21.2	7.68	91
	12-Nov-2019	6.35	4,522	20.0	4.83	132
	5-Aug-2019	6.80	4,715	23.5	NM	205
	14-May-2019	7.16	4,588	22.8	1.28	86
	22-Feb-2019	7.00	4,271	21.1	1.54	161
	14-Nov-2018	6.66	4,422	21.0	2.24	140
	15-Aug-2018	7.01	4,333	21.2	1.94	136
	18-May-2018	7.68	4,250	21.90	2.19	121
	9-Feb-2018	6.80	4,114	22.50	2.37	177
	8-Nov-2017	6.78	4,094	21.70	2.21	194
	10-Aug-2017	6.93	4,018	24.40	3.92	173
	17-May-2017	6.85	3,862	22.43	2.35	167.8
	17-Feb-2017	6.96	3,918	22.40	1.49	157.1
	9-Nov-2016	7.23	3,603	21.93	3.89	57.7
	17-Aug-2016	7.03	3,798	23.70	2.42	41.1
	18-May-2016	6.71	3,439	22.08	1.75	94.3
15-Feb-2016	4.87	3,440	21.28	1.41	208.1	
9-Nov-2015	6.84	3,338	21.02	1.84	185.7	
17-Aug-2015	6.80	3,658	24.41	NM	234.8	

**TABLE 2. SUMMARY OF MONITORING WELL GROUNDWATER FIELD PARAMETERS
DONA ANA DAIRIES, DONA ANA COUNTY, NEW MEXICO**

Monitoring Well	Date Measured	pH	SpC (uS/cm)	Temp (°C)	DO (mg/L)	ORP (mV)					
126-09	20-Nov-2023	Insufficient Water-Parameters Not Collected									
	27-Aug-2023										
	24-May-2023										
	11-Jan-2023										
	8-Nov-2022										
	17-Aug-2022										
	5-May-2022										
	24-Feb-2022	7.76	1,618	15.6	6.2	189					
	9-Nov-2021	Insufficient Water-Parameters Not Collected									
	11-Aug-2021										
	4-May-2021										
	9-Feb-2021										
	9-Sep-2020										
	10-Nov-2020										
	12-Aug-2020	Insufficient Water-Parameters Not Collected									
	14-May-2020						7.88	2,288	22.9	1.59	108
	7-Feb-2020						7.56	1,219	22.3	7.46	16
	12-Nov-2019						7.53	1,238	19.3	5.21	28
	5-Aug-2019						6.91	1,397	NM	NM	255
	14-May-2019						7.83	1,293	23.2	1.99	66
	22-Feb-2019						6.73	1,429	20.6	2.29	170
	14-Nov-2018						6.75	1,259	21.0	2.16	122
	15-Aug-2018						7.73	1,054	24.7	2.51	125
	18-May-2018						7.83	1,154	21.70	2.23	131
	9-Feb-2018						7.69	1,086	20.20	2.64	150
	8-Nov-2017						7.42	942.1	21.10	5.04	250
	10-Aug-2017						7.37	892.7	27.00	4.64	60
	17-May-2017						7.87	793	22.46	3.48	132.6
	20-Feb-2017						7.85	919	18.64	8.37	190.8
	9-Nov-2016						7.42	3,774	21.09	5.63	55.3
	17-Aug-2016						7.74	4,045	23.20	5.85	3.9
	18-May-2016						7.07	3,845	23.15	4.13	66.5
15-Feb-2016	6.34						3,926	22.52	3.30	184.2	
9-Nov-2015	6.79						3,888	22.27	4.75	193.2	
17-Aug-2015	Insufficient Water-Parameters Not Collected										

**TABLE 2. SUMMARY OF MONITORING WELL GROUNDWATER FIELD PARAMETERS
DONA ANA DAIRIES, DONA ANA COUNTY, NEW MEXICO**

Monitoring Well	Date Measured	pH	SpC (uS/cm)	Temp (°C)	DO (mg/L)	ORP (mV)
126-12	20-Nov-2023	7.01	3,383	19.9	NM	69
	27-Aug-2023	7.10	3,430	23.9	NM	NM
	24-May-2023	7.12	3,340	24.3	NM	NM
	11-Jan-2023	7.68	3,290	20.1	1.6	240
	8-Nov-2022	7.07	3,100	21.6	1.8	194
	17-Aug-2022	7.18	2,910	19.8	NM	NM
	5-May-2022	7.33	3,620	21.7	1.6	185
	24-Feb-2022	7.61	3,380	17.0	3.0	208
	9-Nov-2021	7.66	3,210	20.0	1.9	208
	11-Aug-2021	7.33	3,340	20.9	1.6	223
	4-May-2021	7.46	3,320	20.6	2.2	243
	9-Feb-2021	7.40	3,220	20.5	1.8	205
	10-Nov-2020	7.29	3,590	18.9	NM	NM
	12-Aug-2020	7.19	3,570	23.1	NM	NM
	14-May-2020	7.66	3,400	20.7	1.89	90
	10-Feb-2020	7.46	3,070	19.5	4.80	20
	12-Nov-2019	6.76	3,181	18.5	1.14	106
	5-Aug-2019	7.10	3,415	21.7	NM	158
	14-May-2019	7.41	3,259	19.3	1.44	123
	22-Feb-2019	7.33	3,316	19.6	1.17	115
	14-Nov-2018	7.01	3,512	19.5	1.33	125
	15-Aug-2018	7.18	3,732	20.8	1.06	140
	7-Jun-2018	6.89	3,624	20.8	1.21	102
	9-Feb-2018	7.69	3,716	20.6	1.09	89
	8-Nov-2017	7.59	3,920	20.3	-88	-170
	10-Aug-2017	7.20	4,125	22.4	2.96	141
	17-May-2017	6.94	3,377	19.54	2.71	167.8
	20-Feb-2017	7.40	3,494	20.01	5.76	206.0
	9-Nov-2016	7.43	3,321	19.66	4.18	67.2
	17-Aug-2016	7.29	3,696	22.16	2.40	22.8
18-May-2016	7.12	3,103	19.36	2.26	77.4	
15-Feb-2016	6.30	3,291	21.09	1.88	175.2	
9-Nov-2015	7.24	3,276	19.76	2.37	-145.5	
17-Aug-2015	7.21	1,843	20.97	NM	-177.9	

**TABLE 2. SUMMARY OF MONITORING WELL GROUNDWATER FIELD PARAMETERS
DONA ANA DAIRIES, DONA ANA COUNTY, NEW MEXICO**

Monitoring Well	Date Measured	pH	SpC (uS/cm)	Temp (°C)	DO (mg/L)	ORP (mV)
126-13	20-Nov-2023	6.79	NM	21.5	NM	173
	27-Aug-2023	7.04	4,740	25.3	NM	NM
	24-May-2023	6.88	4,960	23.8	NM	NM
	11-Jan-2023	7.46	4,770	NM	1.1	173
	8-Nov-2022	6.45	4,970	21.9	2.8	158
	17-Aug-2022	7.00	5,000	22.2	NM	NM
	5-May-2022	7.13	5,570	21.9	1.9	171
	24-Feb-2022	7.36	5,020	18.7	2.6	214
	9-Nov-2021	7.42	4,830	20.4	2.1	123
	11-Aug-2021	7.32	4,750	22.0	2.3	47
	4-May-2021	7.32	4,910	20.1	3.5	127
	9-Feb-2021	7.28	4,990	18.9	2.4	148
	10-Nov-2020	7.21	4,970	19.6	NM	NM
	12-Aug-2020	6.98	5,180	23.1	NM	NM
	13-May-2020	7.47	5,320	23.2	1.33	56
	7-Feb-2020	7.21	5,039	20.6	9.59	103
	12-Nov-2019	6.61	5,106	20.1	4.62	37
	5-Aug-2019	6.79	5,480	22.8	NM	220
	14-May-2019	6.89	5,297	22.0	1.37	101
	22-Feb-2019	6.62	4,711	20.7	1.29	173
	14-Nov-2018	6.58	5,374	20.8	1.40	146
	15-Aug-2018	7.06	5,136	22.9	1.17	135
	18-May-2018	7.40	5,144	21.20	1.49	60
	9-Feb-2018	7.00	4,810	21.20	1.78	136
	8-Nov-2017	6.96	4,568	21.00	1.13	148
	10-Aug-2017	6.97	4,505	23.30	4.90	128
	17-May-2017	6.99	4,253	21.21	1.87	185.8
	17-Feb-2017	7.06	4,611	20.98	4.72	128.5
	9-Nov-2016	7.31	4,361	21.40	3.84	41.8
	17-Aug-2016	7.24	4,447	21.89	2.13	34.0
18-May-2016	6.86	4,132	20.69	3.01	73.5	
15-Feb-2016	6.38	4,392	21.01	2.18	220.8	
9-Nov-2015	6.96	4,208	21.49	4.32	114.8	
17-Aug-2015	6.81	4,521	22.40	NM	167.3	

**TABLE 2. SUMMARY OF MONITORING WELL GROUNDWATER FIELD PARAMETERS
DONA ANA DAIRIES, DONA ANA COUNTY, NEW MEXICO**

Monitoring Well	Date Measured	pH	SpC (uS/cm)	Temp (°C)	DO (mg/L)	ORP (mV)
Mountain View Dairy						
70-01	9-Nov-2023	7.26	4,702	21.2	2.79	174
	9-Aug-2023	7.20	4,682	24.0	1.36	122
	8-May-2023	7.23	4,640	22.8	2.91	136
	9-Feb-2023	7.22	4,718	21.6	2.09	154
	8-Nov-2022	7.28	4,825	22.6	2.00	37
	9-Aug-2022	7.31	4,892	23.8	2.53	156
	9-May-2022	7.29	4,923	22.9	2.81	147
	15-Feb-2022	7.41	4,550	21.4	2.46	117
	5-Nov-2021	7.61	4,817	23.3	2.91	87
	10-Aug-2021	7.78	4,480	23.0	2.92	74
	10-May-2021	7.34	4,639	22.6	1.33	141
	16-Feb-2021	7.40	4,570	19.3	2.00	99
	12-Nov-2020	7.39	4,401	21.4	2.63	59
	14-Aug-2020	7.57	5,021	26.3	1.38	143
	13-May-2020	7.39	4,522	24.6	2.03	96
	10-Feb-2020	7.26	4,429	21.4	1.06	69
	15-Nov-2019	6.75	4,766	22.0	2.62	136
	7-Aug-2019	7.01	5,108	22.7	NM	192
	16-May-2019	6.49	4,229	23.6	3.47	88
	26-Feb-2019	7.11	4,577	21.5	2.13	145
	15-Nov-2018	7.01	4,448	20.9	2.61	151
	15-Aug-2018	7.28	5,081	23.7	2.29	186
	21-May-2018	6.77	5,065	22.6	2.52	108
	13-Feb-2018	7.09	4,570	22.7	1.48	181
	9-Nov-2017	6.79	4,166	20.8	2.76	133
	14-Aug-2017	7.08	4,321	23.0	3.10	145
	19-May-2017	6.96	3,831	23.21	1.90	173.4
	20-Feb-2017	7.53	3,953	21.11	4.94	116.9
	22-Nov-2016	7.16	4,160	21.91	1.96	32.6
	19-Aug-2016	7.35	3,982	21.67	1.30	61.9
24-May-2016	7.14	3,734	21.64	2.85	37.7	
16-Feb-2016	6.66	3,771	21.03	2.20	191.9	
12-Nov-2015	7.15	3,774	20.91	1.70	171.1	
19-Aug-2015	7.08	3,830	22.50	NM	187.0	

**TABLE 2. SUMMARY OF MONITORING WELL GROUNDWATER FIELD PARAMETERS
DONA ANA DAIRIES, DONA ANA COUNTY, NEW MEXICO**

Monitoring Well	Date Measured	pH	SpC (uS/cm)	Temp (°C)	DO (mg/L)	ORP (mV)
70-02	9-Nov-2023	Insufficient Water-Parameters Not Collected				
	9-Aug-2023	7.23	4,574	23.1	2.15	101
	8-May-2023	7.33	4,508	29.3	2.54	88
	9-Feb-2023	7.28	4,587	22.0	2.33	136
	8-Nov-2022	7.36	4,668	22.8	2.06	175
	9-Aug-2022	7.32	4,744	25.7	2.07	157
	9-May-2022	7.51	4,738	23.4	2.01	102
	15-Feb-2022	7.70	4,663	22.4	2.60	107
	5-Nov-2021	7.72	4,637	23.0	2.53	146
	10-Aug-2021	7.88	4,722	24.0	2.77	71
	10-May-2021	7.64	4,743	23.0	2.66	117
	16-Feb-2021	7.61	4,525	20.1	2.29	102
	12-Nov-2020	7.43	4,518	22.6	2.88	94
	14-Aug-2020	7.69	4,801	23.8	2.63	1.47
	13-May-2020	7.60	4,813	24.1	1.70	86
	10-Feb-2020	7.52	4,540	21.9	0.83	112
	12-Nov-2019	7.16	4,522	21.1	1.33	157
	6-Aug-2019	7.17	4,872	24.7	NM	212
	16-May-2019	7.84	4,765	23.6	5.72	80
	26-Feb-2019	7.29	4,665	22.2	1.86	147
	14-Nov-2018	7.11	4,789	21.3	4.15	137
	15-Aug-2018	7.53	4,744	24.4	3.84	175
	21-May-2018	7.10	4,802	23.4	4.80	111
	13-Feb-2018	7.54	4,790	22.3	1.92	150
	9-Nov-2017	7.11	4,818	21.7	5.60	128
	14-Aug-2017	7.77	4,890	25.3	3.23	149
	19-May-2017	7.23	4,716	22.71	3.27	157.8
	20-Feb-2017	7.81	4,939	22.23	5.27	201.6
	22-Nov-2016	7.79	4,906	22.01	4.21	65.7
	18-Aug-2016	Insufficient Water-Parameters Not Collected				
23-May-2016	7.49	4,846	24.22	2.01	40.2	
16-Feb-2016	6.90	4,816	22.31	2.57	192.5	
12-Nov-2015	7.64	4,737	21.94	NM	174.1	
19-Aug-2015	7.43	4,816	25.90	NM	179.5	

**TABLE 2. SUMMARY OF MONITORING WELL GROUNDWATER FIELD PARAMETERS
DONA ANA DAIRIES, DONA ANA COUNTY, NEW MEXICO**

Monitoring Well	Date Measured	pH	SpC (uS/cm)	Temp (°C)	DO (mg/L)	ORP (mV)
70-04	9-Nov-2023	7.30	4,517	21.7	2.39	182
	9-Aug-2023	7.24	4,701	23.4	2.43	106
	8-May-2023	7.34	4,477	23.6	1.93	20
	9-Feb-2023	7.28	4,610	22.5	2.64	102
	8-Nov-2022	7.29	4,582	22.60	1.59	146
	9-Aug-2022	7.54	4,441	23.5	2.85	127
	9-May-2022	7.58	4,428	23.4	2.33	100
	15-Feb-2022	7.83	4,460	22.2	2.66	83
	5-Nov-2021	7.60	4,408	22.3	2.62	158
	10-Aug-2021	7.54	4,402	23.2	2.38	54
	10-May-2021	7.50	4,463	23.7	3.35	91
	16-Feb-2021	7.66	4,326	20.9	2.40	97
	12-Nov-2020	7.29	4,344	22.8	2.03	87
	14-Aug-2020	7.24	4,391	27.6	2.05	144
	13-May-2020	7.68	4,406	23.7	1.93	113
	10-Feb-2020	7.25	4,400	22.3	1.19	97
	12-Nov-2019	6.61	4,309	21.4	1.18	113
	6-Aug-2019	6.74	4,564	23.7	NM	236
	16-May-2019	6.27	4,521	22.9	3.84	97
	26-Feb-2019	7.09	4,513	22.4	2.34	145
	14-Nov-2018	6.75	4,532	21.8	2.58	133
	15-Aug-2018	7.17	4,401	24.2	2.28	135
	21-May-2018	7.38	4,612	23.0	2.11	95
	13-Feb-2018	7.27	4,433	22.6	1.06	138
	9-Nov-2017	6.68	4,292	21.9	2.47	129
	14-Aug-2017	7.14	4,229	23.2	5.66	131
	19-May-2017	6.97	4,077	22.33	3.11	197.8
	20-Feb-2017	7.42	4,232	22.17	1.24	85.2
	22-Nov-2016	7.20	4,028	20.35	3.28	87.0
	18-Aug-2016	7.06	4,147	23.11	1.81	29.1
23-May-2016	6.99	3,916	22.93	1.77	66.5	
16-Feb-2016	6.63	3,930	21.57	1.36	205.3	
12-Nov-2015	7.08	3,939	21.76	1.17	195.5	
19-Aug-2015	7.01	4,047	22.49	NM	183.3	

**TABLE 2. SUMMARY OF MONITORING WELL GROUNDWATER FIELD PARAMETERS
DONA ANA DAIRIES, DONA ANA COUNTY, NEW MEXICO**

Monitoring Well	Date Measured	pH	SpC (uS/cm)	Temp (°C)	DO (mg/L)	ORP (mV)
Buena Vista Dairy I						
86-01	Jan-2011	Not Sampled Since January 2011				
86-02	Jan-2011	Not Sampled Since January 2011				
Bright Star Dairy						
340-01	8-Nov-2023	7.24	4,394	21.7	1.63	164
	8-Aug-2023	7.22	4,482	23.4	2.43	122
	5-May-2023	7.29	4,514	22.2	2.60	119
	8-Feb-2023	7.26	4,484	20.3	2.23	173
	8-Nov-2022	7.19	4,552	21.3	2.35	200
	27-Oct-2022	7.19	4,507	21.0	2.55	207
	5-May-2022	7.40	4,496	22.0	2.84	157
	14-Feb-2022	7.52	4,411	21.8	2.34	92
	4-Nov-2021	7.30	4,389	21.5	2.64	180
	9-Aug-2021	7.57	4,447	24.7	2.95	83
	6-May-2021	7.43	4,433	23.0	2.93	199
	15-Feb-2021	7.49	4,283	19.6	2.83	50
	11-Nov-2020	7.22	4,254	22.0	2.81	161
	13-Aug-2020	7.59	4,420	23.7	1.93	164
	14-May-2020	7.49	4,430	22.9	2.91	118
	7-Feb-2020	7.45	4,201	21.2	10.22	64
	12-Nov-2019	6.86	4,254	20.7	1.27	142
	6-Aug-2019	7.02	4,458	23.5	NM	158
	14-May-2019	7.12	4,360	22.5	2.23	87
	25-Feb-2019	7.13	4,345	21.1	2.45	129
	15-Nov-2018	7.17	4,455	21.3	2.70	147
	14-Aug-2018	7.19	4,321	23.6	1.60	128
	21-May-2018	6.68	4,484	23.4	1.03	105
	12-Feb-2018	7.32	4,409	21.2	1.09	124
	8-Nov-2017	7.56	4,342	21.1	2.47	113
	11-Aug-2017	7.29	4,350	23.0	1.93	157.2
	18-May-2017	7.08	4,140	21.83	2.61	181.2
	16-Feb-2017	7.27	4,299	20.79	3.68	173.1
10-Nov-2016	7.45	4,244	20.80	2.67	106.8	
23-Aug-2016	7.07	4,391	21.95	1.27	30.4	
18-May-2016	7.09	4,122	22.25	1.76	61.3	
11-Feb-2016	7.36	4,093	21.35	3.07	207.3	
9-Nov-2015	7.25	4,052	21.27	1.34	115.1	
20-Aug-2015	7.26	3,382	22.21	NM	259.1	

**TABLE 2. SUMMARY OF MONITORING WELL GROUNDWATER FIELD PARAMETERS
DONA ANA DAIRIES, DONA ANA COUNTY, NEW MEXICO**

Monitoring Well	Date Measured	pH	SpC (uS/cm)	Temp (°C)	DO (mg/L)	ORP (mV)
340-02	8-Nov-2023	Dry				
	8-Aug-2023					
	5-May-2023					
	5-May-2023					
	8-Feb-2023	Insufficient Water-Parameters Not Collected				
	8-Nov-2022					
	9-Aug-2022	7.13	4,855	23.7	2.88	209
	5-May-2022	7.47	4,860	27.8	2.73	100
	14-Feb-2022	7.44	4,781	22.8	2.73	74
	4-Nov-2021	7.66	4,869	22.5	2.77	144
	9-Aug-2021	7.79	4,828	23.4	2.77	72
	6-May-2021	7.52	4,947	24.0	2.33	189
	15-Feb-2021	7.55	4,946	19.5	2.57	88
	11-Nov-2020	7.20	4,923	23.3	2.90	121
	14-Aug-2020	7.35	4,910	24.6	2.11	128
	14-May-2020	7.70	4,888	23.9	2.73	80
	7-Feb-2020	7.21	4,706	22.1	3.96	66
	12-Nov-2019	6.97	4,783	20.7	3.41	174
	6-Aug-2019	6.98	4,770	25.6	NM	189
	14-May-2019	7.37	4,700	24.5	1.59	66
	25-Feb-2019	7.08	4,714	22.1	1.20	124
	15-Nov-2018	6.93	4,863	21.9	1.41	161
	14-Aug-2018	7.22	4,827	24.4	2.94	131
	21-May-2018	6.86	4,883	23.1	3.01	121
	12-Feb-2018	7.34	4,899	22.2	3.90	123
	8-Nov-2017	6.19	5,022	22.4	3.80	36
	11-Aug-2017	7.75	4,950	26.6	5.91	189
	18-May-2017	7.28	4,948	23.0	2.97	187.6
	16-Feb-2017	7.35	5,096	21.65	8.01	200.5
	10-Nov-2016	7.55	4,904	20.96	7.16	113.8
	23-Aug-2016	Insufficient Water-Parameters Not Collected				
	18-May-2016	Insufficient Water-Parameters Not Collected				
11-Feb-2016	7.30	4,890	22.59	5.44	217.5	
9-Nov-2015	7.10	4,755	22.34	4.09	148.9	
20-Aug-2015	Insufficient Water-Parameters Not Collected					

**TABLE 2. SUMMARY OF MONITORING WELL GROUNDWATER FIELD PARAMETERS
DONA ANA DAIRIES, DONA ANA COUNTY, NEW MEXICO**

Monitoring Well	Date Measured	pH	SpC (uS/cm)	Temp (°C)	DO (mg/L)	ORP (mV)
Dominguez 2 (Former D&J Dairy)						
42-02*	16-Nov-2023	7.29	3,767	20.2	2.91	209
	14-Aug-2023	7.23	3,801	20.3	2.86	241
	10-May-2023	7.28	3,961	20.1	2.07	152
	13-Feb-2023	7.21	4,119	19.5	2.23	162
	10-Nov-2022	7.21	3,910	19.1	2.93	187
	11-Aug-2022	7.24	3,840	20.6	2.92	176
	11-May-2022	7.31	3,990	21.1	2.69	185
	16-Feb-2022	7.61	4,144	19.9	2.12	131
	9-Nov-2021	7.11	3,982	19.6	2.37	206
	11-Aug-2021	7.70	3,866	21.5	2.95	112
	11-May-2021	7.36	3,951	20.4	2.90	204
	18-Feb-2021	7.65	4,047	18.4	1.79	249
	16-Nov-2020	7.43	3,915	19.9	2.37	260
	18-Aug-2020	7.63	3,591	20.9	2.55	235
	22-May-2020	7.32	3,781	20.2	2.91	116
	11-Feb-2020	7.60	3,705	18.0	2.08	71
	22-Nov-2019	6.80	3,672	19.8	6.50	177
	16-Aug-2019	6.94	3,606	20.4	6.35	44
	29-May-2019	6.96	3,866	20.8	4.23	256
	6-Mar-2019	6.86	3,731	19.1	4.67	167
	4-Dec-2018	6.88	3,558	17.8	4.77	173
	22-Aug-2018	7.01	3,749	21.0	4.38	165
	29-May-2018	6.84	4,326	20.1	5.45	142
	21-Feb-2018	7.12	4,248	18.8	7.30	167
	1-Dec-2017	7.06	4,086	19.4	8.58	189
	22-Aug-2017	7.20	3,877	20.8	6.28	73
	2-Jun-2017	7.02	3,769	20.18	4.25	135.5
	6-Mar-2017	7.28	3,729	19.44	4.76	221.2
	28-Nov-2016	7.08	3,698	19.07	3.76	110.2
	31-Aug-2016	7.09	3,787	21.70	4.38	70.7
1-Jun-2016	7.07	3,399	20.65	7.02	48.4	
23-Feb-2016	6.71	3,376	19.57	5.18	208.7	
1-Dec-2015	7.32	3,424	19.70	7.41	262.0	
26-Aug-2015	7.03	3,432	21.70	NM	238.8	

**TABLE 2. SUMMARY OF MONITORING WELL GROUNDWATER FIELD PARAMETERS
DONA ANA DAIRIES, DONA ANA COUNTY, NEW MEXICO**

Monitoring Well	Date Measured	pH	SpC (uS/cm)	Temp (°C)	DO (mg/L)	ORP (mV)
42-03*	16-Nov-2023	7.20	4,905	25.7	1.98	209
	11-Aug-2023	7.19	5,031	26.1	2.72	87
	9-May-2023	7.26	5,034	25.4	2.83	157
	10-Feb-2023	7.19	5,037	24.5	2.45	181
	9-Nov-2022	7.20	5,050	24.6	2.62	190
	10-Aug-2022	7.22	5,141	26.5	1.29	176
	10-May-2022	7.28	5,123	25.9	2.46	178
	16-Feb-2022	7.20	5,009	24.1	1.99	186
	8-Nov-2021	7.20	5,108	26.1	2.90	234
	10-Aug-2021	7.63	5,103	26.9	2.78	64
	11-May-2021	7.22	5,103	26.0	2.96	142
	17-Feb-2021	7.73	4,953	23.7	2.93	131
	16-Nov-2020	7.19	5,048	25.5	2.04	152
	18-Aug-2020	7.37	5,263	26.0	2.83	197
	20-May-2020	7.22	5,220	26.0	2.08	152
	11-Feb-2020	7.75	5,015	22.9	1.58	99
	22-Nov-2019	6.38	5,054	24.6	2.75	88
	16-Aug-2019	6.83	5,376	27.0	2.36	72
	30-May-2019	6.53	5,218	24.9	5.28	208
	6-Mar-2019	7.22	4,511	24.9	5.54	151
	4-Dec-2018	6.90	5,211	23.3	5.39	180
	22-Aug-2018	7.01	5,352	27.1	5.81	88
	29-May-2018	6.64	5,528	25.7	6.21	120
	21-Feb-2018	7.12	5,486	22.6	6.37	147
	1-Dec-2017	7.11	5,502	24.6	7.28	147
	23-Aug-2017	7.14	5,500	26.0	4.27	127
	2-Jun-2017	7.01	5,809	25.36	5.21	118.7
	6-Mar-2017	7.25	5,975	24.20	3.73	202.6
	28-Nov-2016	6.59	5,902	24.49	7.23	116.1
	31-Aug-2016	6.98	5,556	26.70	6.74	55.4
1-Jun-2016	6.92	5,322	24.17	4.78	65.8	
23-Feb-2016	6.73	5,403	22.87	4.17	204.4	
1-Dec-2015	7.21	4,736	20.46	5.68	149.8	
26-Aug-2015	6.97	5,861	25.81	NM	236.5	

**TABLE 2. SUMMARY OF MONITORING WELL GROUNDWATER FIELD PARAMETERS
DONA ANA DAIRIES, DONA ANA COUNTY, NEW MEXICO**

Monitoring Well	Date Measured	pH	SpC (uS/cm)	Temp (°C)	DO (mg/L)	ORP (mV)
42-06*	16-Nov-2023	7.32	3,191	20.8	2.43	252
	11-Aug-2023	7.24	3,301	21.1	2.53	118
	9-May-2023	7.30	3,658	21.7	2.84	137
	10-Feb-2023	7.31	3,669	18.9	2.86	114
	9-Nov-2022	7.43	3,605	21.20	2.86	226.0
	10-Aug-2022	7.36	3,666	22.6	2.88	191
	10-May-2022	7.43	4,799	22.2	2.11	138
	17-Feb-2022	7.40	4,982	20.1	2.39	191
	8-Nov-2021	7.48	5,003	21.6	2.86	139
	11-Aug-2021	7.80	4,934	22.6	2.77	105
	11-May-2021	7.72	5,282	21.8	2.97	-41
	18-Feb-2021	7.85	5,265	21.0	2.49	118
	16-Nov-2020	7.77	4,600	21.5	2.85	246
	22-May-2020	7.40	4,422	21.6	2.90	103
	12-Feb-2020	7.87	4,036	20.1	2.13	104
	22-Nov-2019	7.18	3,830	20.2	5.70	112
	16-Aug-2019	7.31	4,144	21.4	3.45	45
	30-May-2019	7.17	3,631	21.3	4.11	206
	6-Mar-2019	7.32	4,071	21.4	4.30	146
	4-Dec-2018	7.11	4,010	19.3	4.50	182
	22-Aug-2018	7.04	4,029	21.5	4.11	189
	29-May-2018	7.14	4,490	21.0	3.76	132
	21-Feb-2018	7.66	4,349	20.1	4.28	160
	1-Dec-2017	7.31	4,034	21.1	7.12	152
	22-Aug-2017	7.70	4,448	22.1	5.06	74
	2-Jun-2017	7.11	3,441	21.47	123.4	94.8
	6-Mar-2017	7.71	3,171	21.41	5.29	208.9
	28-Nov-2016	7.12	2,947	20.63	8.32	200.7
	31-Aug-2016	7.42	2,932	22.70	6.96	33.5
	1-Jun-2016	7.41	2,996	21.17	6.10	44.5
23-Feb-2016	7.52	3,092	18.97	2.45	95.4	
1-Dec-2015	7.68	3,042	18.65	6.21	188.1	
26-Aug-2015	7.39	3,551	23.21	NM	232.7	
42-07*	10-Nov-2020	Plugged and Abandoned				
	19-Aug-2020	Dry				
	22-May-2020	Dry				
	11-Feb-2020	Dry				
	16-Aug-2019	Dry				
	16-Aug-2019	Dry				
	29-May-2019	Dry				
	6-Mar-2019	Dry				
	4-Dec-2018	Dry				
	22-Aug-2018	Dry				
	29-May-2018	Dry				
	21-Feb-2018	Dry				
	1-Dec-2017	Dry				
	22-Aug-2017	Dry				
	2-Jun-2017	Dry				
	6-Mar-2017	Dry				
	28-Nov-2016	Dry				
31-Aug-2016	Dry					
1-Jun-2016	Dry					
23-Feb-2016	Dry					
1-Dec-2015	Dry					
26-Aug-2015	Dry					

**TABLE 2. SUMMARY OF MONITORING WELL GROUNDWATER FIELD PARAMETERS
DONA ANA DAIRIES, DONA ANA COUNTY, NEW MEXICO**

Monitoring Well	Date Measured	pH	SpC (uS/cm)	Temp (°C)	DO (mg/L)	ORP (mV)
42-08*	16-Nov-2023	7.53	3,883	20.5	1.74	181
	14-Aug-2023	7.20	3,002	23.6	2.16	123
	10-May-2023	7.25	3,015	24.2	2.16	256
	13-Feb-2023	7.33	2,792	15.3	2.16	273
	9-Nov-2022	7.32	3,305	22.0	2.57	219
	10-Aug-2022	7.65	3,326	26.7	2.50	152
	11-May-2022	7.31	2,823	21.3	2.00	181
	17-Feb-2022	7.30	2,869	20.7	2.06	181
	9-Nov-2021	7.25	3,141	23.9	2.23	208
	11-Aug-2021	7.81	3,191	22.1	2.16	117
	11-May-2021	7.75	3,077	21.6	1.68	238
	18-Feb-2021	7.81	2,630	19.6	2.02	148
	16-Nov-2020	7.65	2,775	21.9	2.55	282
	18-Aug-2020	7.82	3,477	23.3	2.40	-225
	22-May-2020	7.57	2,681	23.5	2.14	140
	12-Feb-2020	8.03	2,586	16.3	4.93	79
	22-Nov-2019	7.27	2,751	21.7	6.39	135
	16-Aug-2019	7.39	2,675	21.2	2.11	39
	29-May-2019	7.58	2,106	21.1	4.09	192
	6-Mar-2019	7.54	1,944	20.5	3.81	147
	4-Dec-2018	7.36	1,881	19.9	4.08	155
	22-Aug-2018	7.65	2,490	21.5	3.94	198
	29-May-2018	7.32	1,857	21.3	3.70	131
	21-Feb-2018	7.90	1,962	20.3	3.91	150
	1-Dec-2017	7.98	2,082	21.0	3.83	162
	22-Aug-2017	7.61	2,410	21.6	3.91	89
	2-Jun-2017	7.55	1,691	21.45	4.36	93.6
	6-Mar-2017	7.85	1,626	20.48	2.72	195.1
	28-Nov-2016	7.94	1,684	18.10	6.11	47.50
	31-Aug-2016	Dry				
1-Jun-2016	Dry					
23-Feb-2016	Dry					
1-Dec-2015	Dry					
26-Aug-2015	7.74	2,245	22.68	NM	206.6	

**TABLE 2. SUMMARY OF MONITORING WELL GROUNDWATER FIELD PARAMETERS
DONA ANA DAIRIES, DONA ANA COUNTY, NEW MEXICO**

Monitoring Well	Date Measured	pH	SpC (uS/cm)	Temp (°C)	DO (mg/L)	ORP (mV)
42-09*	10-Nov-2020	Plugged and Abandoned				
	1-Dec-2015	Destroyed				
	26-Aug-2015	7.12	4,773	24.28	NM	245.8
42-10*	15-Nov-2023	7.27	4,010	23.7	1.80	136
	16-Aug-2023	7.29	2,511	30.2	1.84	132
	11-May-2023	7.30	2,633	29.6	2.00	110
	14-Feb-2023	7.30	2,684	26.5	1.88	132
	10-Nov-2022	7.27	2,636	27.4	1.99	213
	11-Aug-2022	7.28	2,477	27.5	1.61	146
	11-May-2022	7.43	2,607	27.8	1.91	148
	17-Feb-2022	7.20	2,496	23.8	1.75	155
	9-Nov-2021	7.19	2,508	27.7	1.85	149
	12-Aug-2021	7.53	2,451	28.4	1.78	83
	12-May-2021	7.52	2,446	26.9	1.79	164
	17-Feb-2021	7.68	2,355	25.9	1.75	119
	13-Nov-2020	7.44	2,324	27.4	1.73	217
	19-Aug-2020	7.14	2,431	28.2	1.78	165
	22-May-2020	7.50	2,455	28.2	1.75	156
	12-Feb-2020	7.31	2,389	25.8	4.85	118
	25-Nov-2019	6.66	2,433	26.9	6.21	199
	19-Aug-2019	6.83	2,488	27.5	6.25	138
	30-May-2019	6.71	2,390	27.1	4.64	131
	6-Mar-2019	7.14	2,391	26.9	5.28	131
	4-Dec-2018	6.82	2,304	22.9	5.63	190
	22-Aug-2018	7.29	2,294	27.9	6.23	151
	30-May-2018	6.65	2,308	27.0	7.30	157
	19-Feb-2018	7.29	2,291	24.9	7.71	136
	4-Dec-2017	7.52	2,250	24.7	7.84	171
	23-Aug-2017	7.33	2,256	26.1	5.61	132
	2-Jun-2017	7.18	2,381	27.3	5.36	119.4
	6-Mar-2017	7.26	2,450	25.77	6.32	195.8
	29-Nov-2016	6.96	2,473	24.61	11.24	113.6
	1-Sep-2016	6.96	2,300	27.70	6.63	NM
1-Jun-2016	7.10	2,300	26.84	5.27	72.3	
23-Feb-2016	7.38	2,072	18.76	3.27	201.8	
1-Dec-2015	7.46	2,222	22.17	7.39	167.4	
25-Aug-2015	7.20	2,565	27.01	NM	220.5	

**TABLE 2. SUMMARY OF MONITORING WELL GROUNDWATER FIELD PARAMETERS
DONA ANA DAIRIES, DONA ANA COUNTY, NEW MEXICO**

Monitoring Well	Date Measured	pH	SpC (uS/cm)	Temp (°C)	DO (mg/L)	ORP (mV)
42-11*	15-Nov-2023	7.47	2,947	24.5	2.12	156
	14-Aug-2023	7.27	2,274	30.3	1.55	104
	10-May-2023	7.43	2,286	25.6	1.72	110
	14-Feb-2023	7.25	2,309	28.7	1.68	197
	10-Nov-2022	7.35	2,296	25.0	1.78	212
	11-Aug-2022	7.36	2,305	28.9	1.73	166
	11-May-2022	7.36	2,340	31.2	1.66	251
	17-Feb-2022	7.63	2,315	26.9	1.62	168
	9-Nov-2021	7.38	2,281	30.2	1.62	8
	12-Aug-2021	7.24	2,260	29.2	1.65	109
	12-May-2021	7.19	2,246	29.7	1.54	146
	17-Feb-2021	7.19	2,178	28.5	1.48	194
	13-Nov-2020	7.33	2,079	28.0	1.48	256
	19-Aug-2020	7.33	2,071	29.0	1.39	225
	22-May-2020	7.31	2,028	28.5	1.48	152
	12-Feb-2020	7.62	1,903	26.0	1.88	143
	25-Nov-2019	6.63	1,890	28.5	7.49	265
	19-Aug-2019	7.18	1,933	25.8	4.00	134
	30-May-2019	7.13	1,857	24.9	5.56	247
	6-Mar-2019	7.30	1,949	25.8	5.94	130
	4-Dec-2018	7.56	1,918	23.8	6.18	156
	22-Aug-2018	7.78	1,915	27.1	7.15	67
	30-May-2018	6.89	1,921	27.7	6.91	173
	19-Feb-2018	7.31	1,997	26.9	7.60	135
	4-Dec-2017	7.26	1,864	25.4	7.49	170
	23-Aug-2017	7.23	1,888	23.2	6.11	70
	2-Jun-2017	7.20	1,974	27.4	5.74	112.3
	3-Mar-2017	7.20	2,118	26.55	3.61	251.2
	29-Nov-2016	7.16	1,926	22.94	8.17	182.8
	1-Sep-2016	7.22	1,940	25.70	7.01	NM
1-Jun-2016	7.29	1,868	24.19	6.63	46.6	
23-Feb-2016	7.37	1,732	17.26	6.38	182.1	
1-Dec-2015	7.49	1,892	24.59	5.89	140.5	
25-Aug-2015	7.37	2,112	28.24	NM	172.7	

**TABLE 2. SUMMARY OF MONITORING WELL GROUNDWATER FIELD PARAMETERS
DONA ANA DAIRIES, DONA ANA COUNTY, NEW MEXICO**

Monitoring Well	Date Measured	pH	SpC (uS/cm)	Temp (°C)	DO (mg/L)	ORP (mV)
42-12*	15-Nov-2023	7.66	1,771	24.6	1.29	120
	16-Aug-2023	7.27	1,757	30.2	1.34	115
	11-May-2023	7.28	1,762	26.4	1.30	150
	14-Feb-2023	7.29	1,805	28.6	1.31	34
	1-Nov-2022	7.41	1,812	26.10	1.31	-166
	11-Aug-2022	7.54	1,808	29.5	1.30	145
	11-May-2022	7.56	1,822	31.0	1.31	154
	17-Feb-2022	7.51	1,820	28.6	1.31	144
	9-Nov-2021	7.41	1,826	30.2	1.31	217
	12-Aug-2021	7.38	1,826	31.4	1.28	97
	12-May-2021	7.43	1,837	29.2	1.32	144
	17-Feb-2021	7.39	1,819	28.6	1.29	72
	13-Nov-2020	7.55	1,830	26.8	1.34	259
	19-Aug-2020	7.58	1,910	30.7	1.35	191
	22-May-2020	7.39	1,918	30.5	1.38	173
	12-Feb-2020	7.65	1,850	27.7	5.06	138
	25-Nov-2019	7.21	1,866	28.4	7.58	184
	19-Aug-2019	7.47	1,940	25.1	5.14	136
	30-May-2019	7.38	1,940	25.7	6.10	270
	6-Mar-2019	7.23	1,988	28.7	6.57	127
	4-Dec-2018	7.25	1,972	22.8	6.61	183
	22-Aug-2018	7.50	1,945	26.9	6.39	182
	30-May-2018	7.23	2,034	28.5	6.75	163
	19-Feb-2018	7.31	2,046	25.8	7.02	149
	4-Dec-2017	8.25	1,900	27.1	7.24	159
	23-Aug-2017	7.50	1,888	26.4	5.48	111
	2-Jun-2017	7.31	2,164	29.07	6.05	115.4
	6-Mar-2017	7.45	2,239	27.71	4.58	240.2
	29-Nov-2016	7.19	2,148	24.24	11.03	226.7
	1-Sep-2016	7.15	2,060	25.70	6.83	NM
1-Jun-2016	7.24	2,039	27.54	5.66	78.6	
23-Feb-2016	7.13	1,980	23.55	7.13	212.0	
1-Dec-2015	7.73	1,893	22.11	7.43	149.0	
25-Aug-2015	7.33	2,204	28.36	NM	201.8	

**TABLE 2. SUMMARY OF MONITORING WELL GROUNDWATER FIELD PARAMETERS
DONA ANA DAIRIES, DONA ANA COUNTY, NEW MEXICO**

Monitoring Well	Date Measured	pH	SpC (uS/cm)	Temp (°C)	DO (mg/L)	ORP (mV)	
42-13*	16-Nov-2023	7.28	3,713	23.7	2.05	120	
	11-Aug-2023	7.20	5,072	28.1	2.91	110	
	9-May-2023	7.29	4,524	24.1	2.62	112	
	10-Feb-2023	7.21	5,134	25.2	2.05	111	
	9-Nov-2022	7.25	5,108	24.60	2.09	281.0	
	10-Aug-2022	7.25	5,113	26.3	2.19	316	
	10-May-2022	7.22	5,340	27.0	2.78	150	
	16-Feb-2022	7.29	5,211	23.1	1.25	161	
	8-Nov-2021	7.41	5,080	23.1	2.35	232	
	11-Aug-2021	7.14	5,186	23.5	2.32	115	
	11-May-2021	7.51	5,254	23.0	2.11	125	
	17-Feb-2021	7.63	5,399	21.6	2.33	107	
	16-Nov-2020	7.38	5,398	22.9	1.44	89	
	18-Aug-2020	7.15	5,591	22.9	1.19	185	
	22-May-2020	7.61	5,551	21.8	1.88	193	
	11-Feb-2020	7.63	5,220	21.2	1.65	172	
	22-Nov-2019	6.47	5,257	22.4	3.59	224	
	16-Aug-2019	Dry/Water Level Below Pump					
	29-May-2019	Dry/Water Level Below Pump					
	6-Mar-2019	7.32	4,217	20.0	4.43	156	
	4-Dec-2018	Dry/Water Level Below Pump					
	22-Aug-2018	7.27	5,419	25.2	5.38	10.0	
	29-May-2018	7.12	5,395	22.2	5.29	151	
	21-Feb-2018	7.47	5,452	21.1	5.65	156	
	1-Dec-2017	7.14	5,320	21.1	2.65	176	
	23-Aug-2017	Pump Not Operational					
	2-Jun-2017	Pump Not Operational					
	6-Mar-2017	7.71	5,085	20.57	5.42	286.3	
	28-Nov-2016	7.11	4,947	19.98	NM	163.7	
	31-Aug-2016	Pump Not Operational					
	1-Jun-2016	Pump Not Operational					
23-Feb-2016	Dry/Water Level Below Pump						
1-Dec-2015	Dry/Water Level Below Pump						
26-Aug-2015	7.09	5,190	25.31	NM	221.7		

**TABLE 2. SUMMARY OF MONITORING WELL GROUNDWATER FIELD PARAMETERS
DONA ANA DAIRIES, DONA ANA COUNTY, NEW MEXICO**

Monitoring Well	Date Measured	pH	SpC (uS/cm)	Temp (°C)	DO (mg/L)	ORP (mV)
Dominguez Dairy						
624-01	10-Nov-2023	7.31	4,362	19.2	1.14	183
	17-Aug-2023	7.20	4,308	22.0	2.70	141
	12-May-2023	7.23	4,321	21.2	1.31	157
	16-Feb-2023	7.26	4,350	19.3	2.25	183
	11-Nov-2022	7.25	4,482	20.2	2.38	193
	12-Aug-2022	7.21	4,375	21.2	2.32	188
	12-May-2022	7.41	4,117	21.2	1.35	217
	18-Feb-2022	7.54	3,690	22.0	2.65	170
	10-Nov-2021	7.71	3,540	22.2	2.60	153
	13-Aug-2021	7.80	4,030	22.1	2.89	116
	14-May-2021	7.58	3,184	22.0	2.39	161
	18-Feb-2021	7.70	3,015	21.8	2.31	141
	13-Nov-2020	7.19	3,126	20.6	2.39	212
	17-Aug-2020	7.43	3,129	22.6	2.36	197
	15-May-2020	7.03	3,468	22.2	NM	162
	12-Feb-2020	7.35	3,009	19.3	2.20	101
	15-Nov-2019	6.68	3,415	21.1	2.44	149
	13-Aug-2019	7.00	3,849	22.1	2.84	83
	20-May-2019	6.48	4,521	21.1	3.48	162
	28-Feb-2019	7.09	4,459	20.7	2.40	167
	20-Nov-2018	7.20	3,459	21.3	2.74	116
	29-Aug-2018	6.96	4,521	21.4	1.60	191
	22-May-2018	6.68	5,126	20.2	2.11	132
	14-Feb-2018	7.15	4,830	20.8	4.37	161
	14-Nov-2017	6.90	4,923	19.9	5.64	59
	15-Aug-2017	7.13	5,031	22.4	5.61	162
	23-May-2017	6.78	4,965	21.07	2.76	169
	22-Feb-2017	7.11	4,816	21.23	6.17	224.3
	14-Nov-2016	7.27	4,854	20.71	4.96	158.3
	19-Aug-2016	7.15	4,500	20.81	4.57	34.7
19-May-2016	6.92	4,002	21.11	5.50	86.6	
16-Feb-2016	6.64	3,664	21.47	5.88	184.6	
10-Nov-2015	7.20	4,741	20.20	3.83	181.7	
7-Aug-2015	6.96	4,585	21.49	2.59	3.8	

**TABLE 2. SUMMARY OF MONITORING WELL GROUNDWATER FIELD PARAMETERS
DONA ANA DAIRIES, DONA ANA COUNTY, NEW MEXICO**

Monitoring Well	Date Measured	pH	SpC (uS/cm)	Temp (°C)	DO (mg/L)	ORP (mV)
624-02	10-Nov-2023	7.25	4,060	19.1	1.77	183
	17-Aug-2023	7.23	4,680	23.5	2.19	167
	12-May-2023	7.39	4,222	20.7	2.82	107
	16-Feb-2023	7.39	4,208	20.1	2.18	190
	11-Nov-2022	7.22	4,278	20.10	2.70	207.0
	12-Aug-2022	7.29	4,885	23.0	2.73	160
	12-May-2022	7.40	5,113	20.3	2.40	202
	18-Feb-2022	7.48	4,811	19.5	2.73	162
	11-Nov-2021	7.76	3,640	20.3	2.69	168
	13-Aug-2021	7.77	3,655	21.2	2.63	116
	14-May-2021	7.90	3,605	20.9	2.74	199
	19-Feb-2021	7.50	3,668	19.5	2.82	130
	12-Nov-2020	7.67	3,335	21.8	2.76	129
	17-Aug-2020	7.45	3,620	22.3	2.09	155
	15-May-2020	7.37	3,500	20.9	2.08	161
	12-Feb-2020	7.36	3,206	19.8	3.12	126
	15-Nov-2019	6.52	3,629	20.0	1.70	134
	13-Aug-2019	6.81	4,463	20.6	1.33	118
	20-May-2019	6.35	4,262	20.2	4.11	153
	28-Feb-2019	6.90	4,017	19.8	2.58	172
	20-Nov-2018	7.04	4,619	19.3	2.66	131
	28-Aug-2018	6.99	4,248	21.8	1.34	178
	22-May-2018	6.76	4,955	20.0	1.67	105
	14-Feb-2018	7.06	4,335	20.8	2.31	149
	14-Nov-2017	6.74	4,248	19.9	2.80	102
	15-Aug-2017	7.08	4,563	20.4	2.95	138
	23-May-2017	6.61	4,368	20.39	2.41	149.1
	22-Feb-2017	7.03	4,238	19.96	4.31	223.1
	14-Nov-2016	7.28	4,135	20.04	1.86	89.4
	19-Aug-2016	7.15	3,695	19.11	1.37	32.5
	19-May-2016	6.81	4,410	19.92	2.07	73.1
16-Feb-2016	6.34	3,845	20.28	1.52	189.2	
10-Nov-2015	7.20	3,548	18.15	1.69	90.4	
7-Aug-2015	7.07	4,158	22.03	1.94	74.8	
624-04	28-Jan-2020	Plugged and Abandoned				
	15-Nov-2019	Dry				
	13-Aug-2019	Dry				
	20-May-2019	Dry				
	28-Feb-2019	Dry				
	20-Nov-2018	Dry				
	29-Aug-2018	Dry				
	22-May-2018	Dry				
	14-Feb-2018	Dry				
	14-Nov-2017	Dry				
	15-Aug-2017	Dry				
	23-May-2017	Dry				
	22-Feb-2017	Dry				
	14-Nov-2016	Dry				
	19-Aug-2016	Dry				
	19-May-2016	Dry				
16-Feb-2016	Dry					
10-Nov-2015	Dry					
7-Aug-2015	Dry					

**TABLE 2. SUMMARY OF MONITORING WELL GROUNDWATER FIELD PARAMETERS
DONA ANA DAIRIES, DONA ANA COUNTY, NEW MEXICO**

Monitoring Well	Date Measured	pH	SpC (uS/cm)	Temp (°C)	DO (mg/L)	ORP (mV)
624-05	28-Jan-2020	Plugged and Abandoned				
	15-Nov-2019	6.85	2,962	21.2	3.12	137
	13-Aug-2019	7.45	3,044	24.4	2.96	97
	16-May-2019	7.66	2,901	21.5	3.07	83
	28-Feb-2019	7.80	2,931	18.5	3.45	158
	20-Nov-2018	Dry				
	29-Aug-2018	Dry				
	22-May-2018	Dry				
	14-Feb-2018	Dry				
	14-Nov-2017	Dry				
	15-Aug-2017	Dry				
	23-May-2017	Dry				
	22-Feb-2017	Dry				
	14-Nov-2016	Dry				
	19-Aug-2016	Dry				
	19-May-2016	Dry				
	16-Feb-2016	Dry				
	10-Nov-2015	Dry				
	7-Aug-2015	Dry				
	624-06	28-Jan-2020	Plugged and Abandoned			
15-Nov-2019		Dry				
13-Aug-2019		Dry				
20-May-2019		Dry				
28-Feb-2019		Dry				
20-Nov-2018		Dry				
29-Aug-2018		Dry				
22-May-2018		Dry				
14-Feb-2018		Dry				
14-Nov-2017		Dry				
15-Aug-2017		Dry				
23-May-2017		Dry				
22-Feb-2017		Dry				
14-Nov-2016		Dry				
19-Aug-2016		Dry				
19-May-2016		Dry				
16-Feb-2016		Dry				
10-Nov-2015		Dry				
7-Aug-2015		Dry				
624-07		28-Jan-2020	Plugged and Abandoned			
	15-Nov-2019	Dry				
	13-Aug-2019	Dry				
	20-May-2019	Dry				
	28-Feb-2019	Dry				
	20-Nov-2018	Dry				
	29-Aug-2018	Dry				
	22-May-2018	Dry				
	14-Feb-2018	Dry				
	14-Nov-2017	Dry				
	15-Aug-2017	Insufficient Water-Parameters Not Collected				
	23-May-2017	Insufficient Water-Parameters Not Collected				
	22-Feb-2017	Insufficient Water-Parameters Not Collected				
	14-Nov-2016	Insufficient Water-Parameters Not Collected				
	19-Aug-2016	Insufficient Water-Parameters Not Collected				
	19-May-2016	Insufficient Water-Parameters Not Collected				
	16-Feb-2016	Dry				
	10-Nov-2015	Insufficient Water-Parameters Not Collected				
	7-Aug-2015	Insufficient Water-Parameters Not Collected				

**TABLE 2. SUMMARY OF MONITORING WELL GROUNDWATER FIELD PARAMETERS
DONA ANA DAIRIES, DONA ANA COUNTY, NEW MEXICO**

Monitoring Well	Date Measured	pH	SpC (uS/cm)	Temp (°C)	DO (mg/L)	ORP (mV)
624-08	28-Jan-2020	Plugged and Abandoned				
	15-Nov-2019	Dry				
	13-Aug-2019	Dry				
	16-May-2019	Dry				
	28-Feb-2019	Dry				
	20-Nov-2018	Dry				
	29-Aug-2018	Dry				
	22-May-2018	Dry				
	14-Feb-2018	Dry				
	14-Nov-2017	Dry				
	15-Aug-2017	Dry				
	23-May-2017	Dry				
	22-Feb-2017	Dry				
	14-Nov-2016	Dry				
	19-Aug-2016	Dry				
	19-May-2016	Dry				
	16-Feb-2016	Dry				
	10-Nov-2015	Dry				
	7-Aug-2015	Dry				
624-09	15-Nov-2023	7.38	2,622	20.7	2.06	158
	16-Aug-2023	7.38	2,226	22.9	1.75	103
	11-May-2023	7.27	2,273	21.0	1.70	56
	16-Feb-2023	7.22	1,807	19.2	1.37	152
	14-Nov-2022	7.26	1,593	20.1	1.17	167
	15-Aug-2022	7.19	1,791	21.4	1.36	126
	13-May-2022	7.25	2,744	20.5	2.22	197
	18-Feb-2022	7.79	2,804	19.9	2.16	116
	10-Nov-2021	7.18	3,050	20.1	2.44	253
	12-Aug-2021	7.75	3,110	22.9	2.27	115
	12-May-2021	7.67	3,562	20.8	2.89	138
	19-Feb-2021	7.82	4,212	20.1	2.54	128
	13-Nov-2020	7.41	2,315	21.2	1.66	169
	17-Aug-2020	7.66	2,935	23.9	2.15	155
	14-May-2020	7.63	2,829	21.9	2.91	103
13-Feb-2020	7.70	3,180	19.3	2.93	183	
624-10	15-Nov-2023	7.29	4,220	19.5	1.83	172
	16-Aug-2023	7.28	4,310	19.7	2.11	236
	11-May-2023	7.33	4,581	19.4	1.43	77
	16-Feb-2023	7.25	4,138	18.1	2.71	128
	14-Nov-2022	7.25	4,086	18.8	1.42	174
	12-Aug-2022	7.33	3,866	21.0	2.94	168
	12-May-2022	7.69	3,577	19.6	2.70	152
	18-Feb-2022	7.61	3,296	19.7	2.51	142
	10-Nov-2021	7.62	3,398	18.9	2.56	197
	12-Aug-2021	7.83	3,111	21.3	2.14	106
	12-May-2021	7.47	3,300	19.9	2.44	162
	19-Feb-2021	7.64	4,022	18.9	2.92	128
	13-Nov-2020	7.20	3,573	19.5	2.56	179
	17-Aug-2020	7.64	3,500	23.5	2.40	138
14-May-2020	7.89	3,883	21.3	2.85	93	
13-Feb-2020	8.03	3,913	18.4	2.66	102	
624-11	10-Nov-2023	7.29	6,573	20.5	2.42	203
	17-Aug-2023	7.26	6,504	23.3	1.71	138
	12-May-2023	7.19	5,738	21.7	2.55	154
	17-Feb-2023	7.23	5,619	20.0	1.19	196
	11-Nov-2022	7.18	5,667	20.9	2.52	198
	12-Aug-2022	7.23	5,276	22.1	1.34	202
	12-May-2022	7.19	5,246	21.1	1.74	193
	18-Feb-2022	7.18	5,195	20.6	1.54	202
	11-Nov-2021	7.66	5,245	21.3	2.10	238
	13-Aug-2021	7.73	5,233	22.3	1.79	87
	14-May-2021	7.42	5,386	22.3	2.31	203
	19-Feb-2021	7.27	5,296	19.7	2.50	200
	12-Nov-2020	7.52	5,160	21.5	1.94	119
	17-Aug-2020	7.72	5,404	22.9	2.21	205
15-May-2020	7.59	5,467	22.2	2.12	195	
13-Feb-2020	7.49	4,506	20.3	1.69	102	

**TABLE 2. SUMMARY OF MONITORING WELL GROUNDWATER FIELD PARAMETERS
DONA ANA DAIRIES, DONA ANA COUNTY, NEW MEXICO**

Monitoring Well	Date Measured	pH	SpC (uS/cm)	Temp (°C)	DO (mg/L)	ORP (mV)
Gonzalez Dairy						
177-01	13-Feb-2020	7.43	6,345	19.5	1.81	121
	19-Nov-2019	6.68	6,420	19.7	1.25	140
	7-Aug-2019	7.00	6,771	20.4	NM	212
	20-May-2019	6.38	6,638	19.1	2.36	154
	27-Feb-2019	7.09	6,752	19.7	2.52	154
	15-Nov-2018	7.02	6,711	20.9	2.29	168
	21-Aug-2018	7.28	6,633	21.7	2.11	158
	22-May-2018	6.83	6,675	19.4	1.87	124
	14-Feb-2018	7.33	6,700	20.7	2.19	146
	10-Nov-2017	6.88	6,663	21.1	1.23	108
	14-Aug-2017	7.21	6,694	21.3	4.55	91
	22-May-2017	6.73	5,875	19.44	1.96	180.2
	22-Feb-2017	7.26	6,219	20.08	3.20	127.7
	10-Nov-2016	7.40	6,333	20.48	1.88	137.7
	23-Aug-2016	7.08	6,380	20.41	0.91	34.7
	20-May-2016	7.15	5,537	19.13	2.48	69.6
	11-Feb-2016	7.33	5,715	19.50	2.90	264.0
11-Nov-2015	7.32	5,790	20.81	1.56	188.9	
21-Aug-2015	7.05	6,118	20.90	NM	242.7	
177-02	13-Feb-2020	7.87	3,271	19.7	2.20	100
	19-Nov-2019	7.05	3,204	19.8	0.79	104
	7-Aug-2019	7.55	2,142	20.7	NM	212
	20-May-2019	6.90	2,317	18.3	1.89	103
	27-Feb-2019	7.63	2,151	19.6	2.22	125
	15-Nov-2018	7.22	2,221	21.2	1.93	144
	21-Aug-2018	7.56	2,966	22.6	2.29	150
	22-May-2018	7.29	2,271	21.8	2.66	115
	14-Feb-2018	7.58	2,460	20.6	3.14	146
	10-Nov-2017	7.49	2,502	21.6	5.05	80
	14-Aug-2017	7.34	4,958	22.3	5.82	135
	22-May-2017	6.94	4,402	19.77	3.23	153.1
	22-Feb-2017	7.35	4,425	20.32	6.18	220.9
	10-Nov-2016	7.50	4,378	21.41	2.38	122.6
	23-Aug-2016	7.16	4,406	21.91	3.99	33.8
	20-May-2016	7.21	3,605	19.22	6.30	86.5
	11-Feb-2016	7.40	4,032	19.78	5.57	227.6
11-Nov-2015	7.36	3,964	21.15	3.82	109.3	
21-Aug-2015	7.11	4,229	21.80	NM	254.6	
177-03A	13-Feb-2020	7.34	3,645	21.7	2.45	109
	19-Nov-2019	6.40	3,577	21.7	0.76	178
	13-Aug-2019	7.00	4,324	22.3	1.80	192
	20-May-2019	6.45	3,895	21.6	1.45	114
	27-Feb-2019	6.86	3,989	21.9	2.13	153
	20-Nov-2018	6.91	4,114	22.5	2.75	130
	21-Aug-2018	7.60	2,728	26.0	1.64	186
	22-May-2018	6.66	3,879	23.6	1.74	105
	15-Feb-2018	7.17	2,854	23.5	1.91	148
	10-Nov-2017	7.07	2,853	21.3	3.35	91
	15-Aug-2017	7.32	3,534	22.7	4.16	106
	22-May-2017	6.86	3,511	21.94	2.90	151.3
	23-Feb-2017	7.27	3,927	21.19	5.41	172.5
	11-Nov-2016	7.39	3,899	21.50	4.63	125.1
	24-Aug-2016	6.95	5,686	21.47	1.31	26.0
	20-May-2016	7.21	3,127	21.65	3.55	74.0
	11-Feb-2016	7.14	6,048	21.69	3.47	277.7
11-Nov-2015	7.27	3,964	20.69	1.89	218.1	
21-Aug-2015	7.08	3,100	22.50	NM	227.6	

**TABLE 2. SUMMARY OF MONITORING WELL GROUNDWATER FIELD PARAMETERS
DONA ANA DAIRIES, DONA ANA COUNTY, NEW MEXICO**

Monitoring Well	Date Measured	pH	SpC (uS/cm)	Temp (°C)	DO (mg/L)	ORP (mV)
177-04	13-Feb-2020	7.62	4,610	21.3	1.52	122
	19-Nov-2019	6.74	4,632	21.4	2.86	180
	13-Aug-2019	7.01	4,987	22.0	1.50	159
	20-May-2019	6.61	4,952	21.6	4.11	232
	27-Feb-2019	6.98	5,164	22.2	2.61	154
	20-Nov-2018	6.99	5,291	19.9	2.09	130
	21-Aug-2018	7.58	5,135	23.8	1.88	166
	22-May-2018	7.01	5,439	23.0	1.48	127
	15-Feb-2018	7.35	5,528	21.3	1.65	150
	10-Nov-2017	7.10	5,622	21.2	2.19	69
	16-Aug-2017	7.11	5,919	21.6	4.68	162
	22-May-2017	6.69	5,762	21.69	2.82	162.5
	23-Feb-2017	7.24	5,668	20.82	2.29	183.4
	10-Nov-2016	7.40	6,333	20.48	1.88	137.7
	24-Aug-2016	7.02	6,238	21.68	1.02	31.1
	23-May-2016	7.21	5,536	21.48	4.08	62.3
	11-Feb-2016	7.13	6,020	21.01	3.80	210.9
	11-Nov-2015	7.39	5,889	26.93	1.61	227.1
	21-Aug-2015	6.96	6,091	21.70	NM	226.8
	177-05	13-Feb-2020	7.35	5,688	20.9	1.73
19-Nov-2019		6.71	5,904	22.2	6.32	246
13-Aug-2019		7.01	6,519	22.3	1.12	67
20-May-2019		6.76	6,249	22.0	4.25	247
27-Feb-2019		7.07	6,088	21.6	2.09	164
20-Nov-2018		6.96	6,217	21.4	2.50	133
21-Aug-2018		7.51	6,361	24.2	2.17	157
22-May-2018		7.01	6,496	22.0	1.88	116
15-Feb-2018		7.23	6,687	21.5	3.17	139
10-Nov-2017		6.89	6,601	21.5	3.01	110
15-Aug-2017		7.12	6,859	21.9	5.42	143
22-May-2017		6.70	6,302	21.06	2.27	161.5
23-Feb-2017		7.44	5,640	21.14	4.19	208.8
11-Nov-2016		7.24	5,833	21.20	3.99	109.0
24-Aug-2016		7.02	5,759	20.89	2.90	35.1
20-May-2016		7.09	5,411	20.88	3.46	98.7
11-Feb-2016		7.27	4,910	20.54	3.48	202.9
11-Nov-2015		7.45	5,241	18.92	3.84	151.4
21-Aug-2015		7.17	5,662	21.50	NM	219.1
177-06		13-Feb-2020	Dry Since February 2020			
	19-Nov-2019	Dry				
	13-Aug-2019	Dry				
	20-May-2019	Dry				
	27-Feb-2019	Dry				
	20-Nov-2018	Dry				
	21-Aug-2018	Dry				
	22-May-2018	Dry				
	15-Feb-2018	Dry				
	10-Nov-2017	Dry				
	14-Aug-2017	Dry				
	22-May-2017	Dry				
	23-Feb-2017	Dry				
	11-Nov-2016	Dry				
	24-Aug-2016	Dry				
	23-May-2016	Dry				
	11-Feb-2016	Dry				
	11-Nov-2015	Dry				
	21-Aug-2015	Dry				

**TABLE 2. SUMMARY OF MONITORING WELL GROUNDWATER FIELD PARAMETERS
DONA ANA DAIRIES, DONA ANA COUNTY, NEW MEXICO**

Monitoring Well	Date Measured	pH	SpC (uS/cm)	Temp (°C)	DO (mg/L)	ORP (mV)
177-07R	13-Feb-2020	7.58	4,327	21.0	1.22	107
	19-Nov-2019	6.73	4,360	21.4	1.47	193
	7-Aug-2019	7.11	4,709	22.8	NM	234
	20-May-2019	6.66	4,663	22.0	3.19	314
	27-Feb-2019	7.24	4,760	21.6	1.66	150
	20-Nov-2018	7.03	4,938	20.5	1.86	128
	21-Aug-2018	7.39	5,116	23.2	1.34	152
	22-May-2018	6.64	5,311	21.7	1.54	125
	14-Feb-2018	7.19	5,452	22.3	1.86	153
	10-Nov-2017	6.87	5,582	21.6	2.94	125
	14-Aug-2017	7.33	5,720	22.5	4.20	180
	22-May-2017	6.95	5,436	21.25	3.76	153.4
	23-Feb-2017	7.59	5,310	20.16	5.08	209.2
	11-Nov-2016	7.58	5,319	20.93	6.56	157.2
	23-Aug-2016	7.24	5,416	21.69	2.41	33.9
	23-May-2016	7.21	5,036	21.90	2.41	62.8
	11-Feb-2016	7.34	5,032	20.87	3.30	236.8
	11-Nov-2015	7.32	5,017	20.61	3.47	201.4
21-Aug-2015	7.07	5,710	23.11	NM	250.2	
CENTRAL AREA						
Buena Vista Dairy II						
74-01	17-Nov-2023	7.22	4,513	22.6	2.53	201
	18-Aug-2023	7.25	4,405	23.7	2.07	92
	15-May-2023	7.24	4,671	22.7	1.73	133
	17-Feb-2023	7.38	4,630	20.8	2.02	141
	15-Nov-2022	7.26	4,687	20.0	2.86	164
	16-Aug-2022	7.24	4,661	22.7	2.66	154
	13-May-2022	7.43	4,548	22.7	2.80	156
	22-Feb-2022	7.60	4,515	23.5	2.84	132
	12-Nov-2021	7.20	4,776	22.4	2.04	62
	19-Aug-2021	7.39	5,141	26.2	2.38	103
	17-May-2021	7.29	5,475	23.1	2.90	-181
	22-Feb-2021	7.52	6,000	22.1	2.69	-214
	17-Nov-2020	7.29	9,629	22.3	1.15	98
	21-Aug-2020	7.28	4,543	23.2	1.43	206
	18-May-2020	7.34	5,599	23.8	2.35	114
	14-Feb-2020	7.85	5,729	19.8	2.13	127
	19-Nov-2019	6.71	6,110	22.9	5.08	192
	14-Aug-2019	7.34	4,632	22.4	1.10	171
	21-May-2019	6.60	4,802	22.0	2.08	304
	28-Feb-2019	7.36	4,943	22.2	1.34	162
	16-Nov-2018	7.15	6,129	21.4	1.11	172
	29-Aug-2018	7.21	5,860	22.3	1.49	197
	23-May-2018	6.97	4,912	22.9	1.66	138
	19-Feb-2018	7.59	5,408	21.4	2.10	154
	14-Nov-2017	7.05	5,148	21.9	2.31	135
	16-Aug-2017	7.46	5,622	22.6	2.91	182
	26-May-2017	6.76	4,253	21.77	2.40	144.9
	24-Feb-2017	7.46	4,517	20.58	1.94	187.8
	14-Nov-2016	7.48	5,369	21.87	1.43	141.5
	24-Aug-2016	7.22	5,633	21.78	1.92	30.9
	25-May-2016	7.20	4,355	21.89	2.02	106.5
	18-Feb-2016	7.28	4,147	21.21	1.64	365.1
12-Nov-2015	7.26	3,836	20.15	1.06	210.6	
24-Aug-2015	7.37	4,959	22.17	NM	243.2	

**TABLE 2. SUMMARY OF MONITORING WELL GROUNDWATER FIELD PARAMETERS
DONA ANA DAIRIES, DONA ANA COUNTY, NEW MEXICO**

Monitoring Well	Date Measured	pH	SpC (uS/cm)	Temp (°C)	DO (mg/L)	ORP (mV)
74-02	17-Nov-2023	7.18	4,579	22.2	2.63	183
	18-Aug-2023	7.19	4,080	24.0	2.88	52
	12-May-2023	7.27	3,911	23.7	2.92	84
	17-Feb-2023	7.35	3,886	20.2	2.90	145
	14-Nov-2022	7.29	3,874	21.2	2.37	-35
	15-Aug-2022	7.24	3,905	23.9	2.87	3
	13-May-2022	7.38	3,766	21.5	2.92	132
	22-Feb-2022	7.22	3,814	20.1	2.95	125
	11-Nov-2021	7.56	3,871	22.1	2.95	-116
	19-Aug-2021	7.68	4,036	24.4	2.08	-16
	14-May-2021	7.33	5,162	23.0	2.70	148
	22-Feb-2021	7.22	8,153	20.7	2.18	-253
	17-Nov-2020	7.20	1,364	22.8	0.96	175
	21-Aug-2020	7.48	3,876	23.2	2.09	255
	15-May-2020	7.43	3,795	24.0	NM	137
	14-Feb-2020	7.43	3,780	20.0	3.14	126
	19-Nov-2019	6.82	4,182	22.5	8.73	223
	14-Aug-2019	7.10	3,666	22.2	1.36	271
	21-May-2019	6.90	3,723	20.2	2.19	313
	28-Feb-2019	7.36	3,730	20.9	1.81	158
	15-Nov-2018	7.19	3,611	22.5	2.13	167
	23-Aug-2018	7.80	3,478	22.9	1.98	118
	23-May-2018	6.97	3,709	21.2	3.17	129
	15-Feb-2018	7.66	3,569	20.6	3.62	136
	14-Nov-2017	6.97	3,517	22.4	2.27	132
	15-Aug-2017	7.32	3,427	22.3	5.21	122
	25-May-2017	6.85	3,630	21.72	3.06	133.3
	24-Feb-2017	7.43	3,688	20.88	6.47	216.4
	14-Nov-2016	7.54	3,788	22.07	3.76	92.6
	24-Aug-2016	7.10	3,884	21.90	1.83	30.9
	25-May-2016	7.20	3,408	20.47	2.39	92.2
	18-Feb-2016	7.60	3,995	21.01	3.82	398.5
11-Nov-2015	7.32	3,315	21.76	0.90	194.9	
24-Aug-2015	7.22	3,377	21.48	NM	252.2	
74-03	17-Nov-2023	7.20	2,503	23.3	1.86	236
	18-Aug-2023	7.22	2,066	23.1	1.60	125
	12-May-2023	7.32	2,493	22.0	1.88	91
	17-Feb-2023	7.30	2,660	20.2	2.10	163
	14-Nov-2022	7.42	2,296	22.4	1.76	167
	15-Aug-2022	7.22	2,087	24.8	1.56	274
	13-May-2022	7.33	2,064	21.2	1.53	196
	22-Feb-2022	7.20	2,187	21.3	1.59	174
	11-Nov-2021	7.84	2,271	23.0	1.69	109
	13-Aug-2021	7.70	2,265	23.9	1.67	97
	14-May-2021	7.80	2,299	22.4	1.77	81
	22-Feb-2021	7.90	2,323	21.3	1.76	149
	19-Aug-2020	7.72	2,451	26.4	1.77	91
	15-May-2020	7.51	2,429	23.9	1.77	139
	14-Feb-2020	7.71	2,221	19.3	3.89	138
	19-Nov-2019	7.02	2,260	23.5	10.10	232
	14-Aug-2019	7.45	2,331	22.4	1.18	192
	21-May-2019	7.08	2,335	20.4	2.50	288
	28-Feb-2019	7.54	2,309	21.4	2.31	148
	15-Nov-2018	7.40	2,636	23.2	2.66	150
	23-Aug-2018	7.35	2,883	23.4	3.11	129
	23-May-2018	7.61	3,186	21.4	3.84	136
	15-Feb-2018	7.61	3,316	20.9	4.13	141
	14-Nov-2017	7.48	3,464	23.5	3.76	139
	15-Aug-2017	7.54	3,447	23.5	3.91	148
	25-May-2017	6.84	3,826	21.27	1.92	142.5
	24-Feb-2017	7.59	3,770	20.67	4.64	134.8
	14-Nov-2016	7.60	3,886	23.01	2.64	96.4
	24-Aug-2016	7.19	4,189	22.91	1.02	27.2
	25-May-2016	7.21	3,828	20.39	3.47	100.9
	18-Feb-2016	7.38	4,067	20.10	2.79	597.0
	12-Nov-2015	7.36	4,868	20.28	1.11	233.4
24-Aug-2015	7.24	5,541	22.39	NM	263.7	

**TABLE 2. SUMMARY OF MONITORING WELL GROUNDWATER FIELD PARAMETERS
DONA ANA DAIRIES, DONA ANA COUNTY, NEW MEXICO**

Monitoring Well	Date Measured	pH	SpC (uS/cm)	Temp (°C)	DO (mg/L)	ORP (mV)
74-04	17-Nov-2023	7.28	3,641	23.0	2.78	237
	21-Aug-2023	7.20	3,543	22.5	2.67	126
	15-May-2023	7.33	2,915	22.0	2.13	79
	21-Feb-2023	7.23	3,570	21.8	2.77	154
	14-Nov-2022	7.25	3,581	20.9	2.74	276.0
	16-Aug-2022	7.30	3,365	23.4	2.31	240
	16-May-2022	7.18	3,433	21.9	2.29	221
	23-Feb-2022	7.28	3,637	20.4	2.88	186
	12-Nov-2021	7.68	3,587	22.9	2.77	109
	19-Aug-2021	7.42	4,083	23.3	2.36	99
	17-May-2021	7.82	3,530	23.2	2.68	-175
	22-Feb-2021	7.84	3,387	21.8	2.66	-16
	17-Nov-2020	7.33	4,207	23.2	2.36	8
	21-Aug-2020	7.48	3,513	23.1	2.61	160
	18-May-2020	7.32	3,202	23.3	2.32	96
	14-Feb-2020	7.46	3,235	21.6	2.12	118
	20-Nov-2019	6.84	3,375	21.2	6.28	207
	14-Aug-2019	7.01	3,600	22.8	1.30	163
	21-May-2019	6.61	2,882	21.3	2.30	276
	1-Mar-2019	6.84	3,426	20.7	1.51	166
	16-Nov-2018	7.02	3,437	21.8	1.55	146
	31-Aug-2018	7.11	3,329	22.5	1.83	265
	23-May-2018	6.84	3,068	22.8	2.27	125
	19-Feb-2018	7.53	3,139	20.4	2.05	129
	14-Nov-2017	7.37	3,128	22.1	3.54	142
	16-Aug-2017	7.32	3,229	23.5	4.24	130
	26-May-2017	6.96	2,980	22.2	2.76	144.7
	24-Feb-2017	7.46	2,973	19.48	2.60	224.5
	15-Nov-2016	7.62	3,099	21.20	3.28	85.0
	24-Aug-2016	6.82	3,243	21.16	2.50	103.4
25-May-2016	7.09	3,131	22.67	2.22	114.3	
18-Feb-2016	7.35	2,978	21.11	2.85	328.1	
12-Nov-2015	7.32	2,868	17.58	3.06	197.2	
24-Aug-2015	7.41	3,134	22.42	NM	182.8	

**TABLE 2. SUMMARY OF MONITORING WELL GROUNDWATER FIELD PARAMETERS
DONA ANA DAIRIES, DONA ANA COUNTY, NEW MEXICO**

Monitoring Well	Date Measured	pH	SpC (uS/cm)	Temp (°C)	DO (mg/L)	ORP (mV)
74-05	17-Nov-2023	7.30	3,526	23.5	2.71	273
	21-Aug-2023	7.18	3,575	23.3	2.69	199
	15-May-2023	7.27	3,550	23.3	2.68	307
	21-Feb-2023	7.28	3,537	21.8	2.71	177
	15-Nov-2022	7.24	3,531	22.50	2.70	316
	16-Aug-2022	7.27	3,499	24.4	2.65	277
	16-May-2022	7.58	3,491	23.9	2.64	249
	23-Feb-2022	7.66	3,458	22.4	2.62	164
	15-Nov-2021	7.20	3,464	23.1	2.64	185
	31-Aug-2021	7.65	3,522	25.3	2.61	161
	17-May-2021	7.79	3,582	24.6	2.68	18
	23-Feb-2021	7.83	3,496	22.6	2.66	-4
	17-Nov-2020	7.65	4,343	22.5	2.78	-25
	21-Aug-2020	7.70	3,493	22.9	2.57	135
	18-May-2020	7.33	3,440	23.1	2.54	188
	14-Feb-2020	7.20	3,231	21.5	4.91	81
	20-Nov-2019	6.80	3,216	21.4	6.01	67
	13-Aug-2019	7.03	3,353	22.7	0.71	-16
	21-May-2019	6.46	3,256	21.2	2.24	272
	1-Mar-2019	6.97	3,331	21.5	1.79	154
	16-Nov-2018	7.06	3,373	22.0	2.28	144
	29-Aug-2018	6.96	3,353	22.8	2.91	184
	23-May-2018	6.83	3,380	22.2	2.54	129
	19-Feb-2018	7.25	3,337	21.3	1.46	137
	14-Nov-2017	7.09	3,151	21.9	0.94	111
	16-Aug-2017	7.34	3,211	22.6	3.36	146
	26-May-2017	7.02	3,214	22.09	3.70	154.2
	24-Feb-2017	7.39	3,122	19.58	3.26	155.2
	15-Nov-2016	7.30	3,141	21.77	1.07	97.4
	25-Aug-2016	6.82	3,197	21.52	1.76	48.2
25-May-2016	7.12	2,946	22.09	2.01	97.3	
18-Feb-2016	7.18	2,933	20.38	2.33	302.7	
12-Nov-2015	7.20	2,923	20.12	1.23	214.2	
24-Aug-2015	7.11	3,179	24.11	NM	240.7	

**TABLE 2. SUMMARY OF MONITORING WELL GROUNDWATER FIELD PARAMETERS
DONA ANA DAIRIES, DONA ANA COUNTY, NEW MEXICO**

Monitoring Well	Date Measured	pH	SpC (uS/cm)	Temp (°C)	DO (mg/L)	ORP (mV)
River Valley Dairy						
167-01A	15-Nov-2017	7.71	2,966	20.20	2.16	48.0
	16-Aug-2017	7.47	3,611	20.70	4.62	195.0
	23-May-2017	6.80	3,601	19.30	1.84	111.9
	27-Feb-2017	7.37	3,610	19.07	5.06	154.2
	15-Nov-2016	7.89	3,725	20.38	2.78	85.7
	30-Aug-2016	7.35	3,621	20.60	2.61	59.1
	24-May-2016	7.36	3,576	18.60	3.24	43.4
	17-Feb-2016	6.92	3,973	18.55	1.96	79.6
	16-Nov-2015	7.34	4,001	19.50	1.41	221.2
	24-Aug-2015	7.47	4,361	27.51	NM	77.5
167-02	15-Nov-2017	7.20	3,960	20.30	3.40	79.0
	16-Aug-2017	7.11	3,807	20.50	3.96	191.0
	23-May-2017	6.76	3,244	20.77	2.10	135.8
	27-Feb-2017	7.15	3,244	19.39	7.10	219.2
	15-Nov-2016	7.59	2,934	20.29	3.92	99.6
	30-Aug-2016	7.39	2,497	21.40	2.71	72.2
	24-May-2016	7.17	2,452	20.20	4.11	56.6
	17-Feb-2016	6.92	2,312	20.00	6.49	155.5
	16-Nov-2015	Dry				
	24-Aug-2015	Insufficient Water-Parameters Not Collected				
167-03	15-Nov-2017	7.34	2,960	21.80	1.90	81.0
	17-Aug-2017	7.33	2,947	22.50	3.31	155.0
	25-May-2017	6.96	2,851	22.55	2.56	172.5
	27-Feb-2017	7.26	2,839	21.87	3.18	218.6
	15-Nov-2016	7.77	2,911	22.56	1.07	-108.6
	31-Aug-2016	7.44	2,964	23.20	1.96	36.7
	25-May-2016	7.06	2,836	21.69	2.41	117.5
	17-Feb-2016	6.93	2,803	21.72	2.94	196.6
	16-Nov-2015	7.34	2,998	21.43	1.46	246.1
	25-Aug-2015	7.29	3,054	21.90	NM	198.2
167-04	15-Nov-2017	7.52	5,469	21.30	2.64	42.0
	17-Aug-2017	7.53	5,446	21.50	6.11	52.0
	25-May-2017	7.05	5,234	21.16	2.13	180.0
	27-Feb-2017	7.42	5,216	20.62	3.46	203.8
	15-Nov-2016	7.72	5,388	20.93	3.48	83.8
	30-Aug-2016	7.31	5,342	21.80	4.21	34.1
	24-May-2016	7.43	5,088	21.54	1.76	39.8
	17-Feb-2016	6.74	4,856	20.05	3.37	209.0
	16-Nov-2015	7.50	4,234	20.07	NM	223.0
	25-Aug-2015	7.35	4,944	21.43	NM	171.1
167-05	15-Nov-2017	7.00	4,945	20.80	2.45	163.0
	17-Aug-2017	7.21	4,818	20.20	4.84	198.0
	25-May-2017	6.47	4,277	19.64	2.47	148.5
	28-Feb-2017	7.29	4,459	19.03	1.78	216.8
	16-Nov-2016	7.65	4,456	19.72	3.17	67.8
	30-Aug-2016	7.17	4,229	21.50	2.19	70.9
	26-May-2016	7.27	3,995	18.67	3.11	57.4
	17-Feb-2016	6.80	4,183	20.42	2.16	147.7
	13-Nov-2015	7.25	4,146	19.81	1.11	142.6
	25-Aug-2015	7.20	4,308	20.69	NM	223.5
167-06	15-Nov-2017	7.31	3,611	21.80	2.76	160
	17-Aug-2017	7.25	3,591	22.00	4.88	18.0
	25-May-2017	6.91	3,600	22.49	2.12	136.6
	27-Feb-2017	7.16	3,590	21.93	2.51	188.3
	15-Nov-2016	7.68	3,588	21.80	1.86	76.7
	30-Aug-2016	7.17	3,557	22.70	2.76	57.3
	24-May-2016	7.22	3,450	21.69	2.71	35.7
	17-Feb-2016	6.45	3,497	21.21	2.01	276.0
	13-Nov-2015	7.26	3,612	20.60	1.02	171.1
	24-Aug-2015	7.13	3,782	22.71	NM	252.5

**TABLE 2. SUMMARY OF MONITORING WELL GROUNDWATER FIELD PARAMETERS
DONA ANA DAIRIES, DONA ANA COUNTY, NEW MEXICO**

Monitoring Well	Date Measured	pH	SpC (uS/cm)	Temp (°C)	DO (mg/L)	ORP (mV)
167-07	15-Nov-2017	8.02	1,733	20.40	1.86	62.0
	17-Aug-2017	7.62	1,866	20.10	5.34	46.0
	23-May-2017	7.98	1,685	19.46	2.40	138.3
	27-Feb-2017	7.68	1,460	19.29	1.59	197.6
	15-Nov-2016	8.12	1,415	20.13	1.78	20.2
	30-Aug-2016	7.54	1,771	20.70	1.70	16.2
	24-May-2016	7.65	1,330	19.47	0.75	-17.1
	17-Feb-2016	6.91	1,648	19.77	1.31	-76.3
	13-Nov-2015	7.64	1,825	18.72	1.12	-114.1
	24-Aug-2015	7.29	4,621	20.89	NM	72.4
167-08	15-Nov-2017	7.19	5,859	18.90	2.52	62.0
	17-Aug-2017	7.17	5,651	20.40	4.11	149.0
	25-May-2017	6.89	5,064	19.19	2.83	152.8
	28-Feb-2017	7.22	5,174	18.33	1.08	198.6
	16-Nov-2016	7.90	5,083	18.99	1.67	82.8
	31-Aug-2016	7.06	4,725	19.80	2.17	54.1
	25-May-2016	7.14	3,874	18.39	1.76	92.8
	17-Feb-2016	6.90	4,601	20.11	2.26	75.6
	23-Nov-2015	7.38	3,463	17.09	1.27	32.8
	25-Aug-2015	Bailer Stuck in Well-Parameters Not Collected				
167-09	15-Nov-2017	7.00	4,927	20.00	3.33	146.0
	17-Aug-2017	7.16	4,573	20.00	4.22	102.0
	25-May-2017	6.70	3,718	19.06	2.56	137.2
	27-Feb-2017	7.18	3,604	18.71	4.08	225.4
	15-Nov-2016	7.63	3,662	19.61	2.21	179.6
	30-Aug-2016	7.14	3,500	20.60	1.67	64.3
	24-May-2016	7.27	3,366	18.23	2.54	40.3
	17-Feb-2016	7.00	3,328	17.96	1.78	109.9
	13-Nov-2015	7.25	3,381	18.69	1.06	0.5
	25-Aug-2015	7.21	3,352	19.37	NM	226.5

**TABLE 2. SUMMARY OF MONITORING WELL GROUNDWATER FIELD PARAMETERS
DONA ANA DAIRIES, DONA ANA COUNTY, NEW MEXICO**

Monitoring Well	Date Measured	pH	SpC (uS/cm)	Temp (°C)	DO (mg/L)	ORP (mV)
Big Sky Dairy						
833-01	5-Aug-2017	Plugged and Abandoned				
	31-May-2017	Dry				
	1-Mar-2017	Dry				
	17-Nov-2016	Dry				
	29-Aug-2016	Dry				
	27-May-2016	Dry				
	22-Feb-2016	Dry				
	18-Nov-2015	Dry				
	27-Aug-2015	Dry				
833-02	20-Nov-2023	7.26	6,305	19.8	1.58	257
	22-Aug-2023	7.26	6,276	20.9	2.43	133
	16-May-2023	7.22	5,959	20.7	1.74	211
	22-Feb-2023	7.24	5,841	18.2	2.66	186
	17-Nov-2022	7.24	5,531	19.0	2.59	197
	17-Aug-2022	7.27	4,715	20.2	2.66	152
	18-May-2022	7.24	6,273	19.5	2.08	186
	24-Feb-2022	7.67	5,532	16.8	2.59	201
	16-Nov-2021	7.19	6,064	19.5	2.83	205
	17-Aug-2021	7.73	5,666	20.6	2.88	97
	18-May-2021	7.77	6,551	20.5	2.15	136
	24-Feb-2021	7.73	5,908	18.9	2.59	110
	18-Nov-2020	7.64	5,770	19.6	1.11	108
	24-Aug-2020	7.72	5,044	22.2	2.11	167
	20-May-2020	7.43	4,981	21.2	2.75	244
	17-Feb-2020	7.97	5,542	20.1	2.37	95
	21-Nov-2019	7.72	4,903	19.6	3.14	212
	14-Aug-2019	7.23	6,553	22.2	1.82	117
	22-May-2019	6.98	6,354	20.9	1.88	281
	4-Mar-2019	7.11	4,796	18.7	2.11	154
	26-Nov-2018	7.23	6,466	19.8	2.36	143
	31-Aug-2018	7.34	6,321	20.4	2.61	178
	29-May-2018	6.98	6,471	19.7	2.11	144
	21-Feb-2018	7.66	6,511	20.9	3.36	164
	16-Nov-2017	7.30	6,625	20.4	3.63	155
	1-Sep-2017	7.71	5,105	19.5	4.67	190
	30-May-2017	7.09	6,119	19.8	2.53	178.4
28-Feb-2017	7.24	6,231	20.29	2.08	178.6	
18-Nov-2016	7.48	6,309	20.07	4.65	62.0	
29-Aug-2016	7.12	6,158	23.70	2.06	73.6	
31-May-2016	7.37	6,169	20.14	5.43	39.3	
22-Feb-2016	7.18	3,622	19.53	3.76	232.3	
18-Nov-2015	7.58	5,996	19.69	2.45	210.1	
27-Aug-2015	8.17	3,718	24.36	NM	176.1	
833-03	5-Aug-2017	Plugged and Abandoned				
	1-Sep-2017	Dry				
	30-May-2017	Dry				
	1-Mar-2017	Dry				
	17-Nov-2016	Dry				
	29-Aug-2016	Dry				
	27-May-2016	Dry				
	18-Feb-2016	Dry				
	18-Nov-2015	Dry				
	27-Aug-2015	Dry				

**TABLE 2. SUMMARY OF MONITORING WELL GROUNDWATER FIELD PARAMETERS
DONA ANA DAIRIES, DONA ANA COUNTY, NEW MEXICO**

Monitoring Well	Date Measured	pH	SpC (uS/cm)	Temp (°C)	DO (mg/L)	ORP (mV)
833-04	20-Nov-2023	7.23	4,758	21.2	2.37	289
	22-Aug-2023	7.15	4,648	22.1	1.81	142
	16-May-2023	7.23	4,283	21.5	2.33	164
	21-Feb-2023	7.30	4,697	20.9	2.05	225
	17-Nov-2022	7.21	4,400	20.5	1.86	199
	17-Aug-2022	7.21	3,889	21.6	2.72	164
	16-May-2022	7.52	4,587	23.0	2.68	164
	24-Feb-2022	7.20	4,236	18.2	2.46	203
	15-Nov-2021	7.69	4,420	22.1	2.91	116
	17-Aug-2021	7.31	4,365	22.2	2.39	115
	17-May-2021	7.64	3,505	21.6	2.45	137
	23-Feb-2021	7.78	3,720	21.3	2.62	82
	18-Nov-2020	7.44	3,882	19.9	2.47	112
	24-Aug-2020	7.45	3,577	22.7	2.60	140
	20-May-2020	7.75	3,571	22.3	2.92	225
	17-Feb-2020	7.71	3,778	20.8	2.30	89
	20-Nov-2019	7.00	4,257	21.0	10.93	278
	15-Aug-2019	7.04	5,007	21.3	0.97	114
	23-May-2019	6.44	4,367	21.3	1.64	292
	4-Mar-2019	7.31	3,873	20.7	1.34	137
	26-Nov-2018	7.40	5,024	20.7	1.74	134
	4-Sep-2018	7.22	4,860	21.5	1.75	104
	24-May-2018	7.05	4,739	21.1	1.96	112
	20-Feb-2018	7.71	3,795	20.5	3.84	152
	20-Nov-2017	7.41	4,752	20.6	3.08	125
	8-Sep-2017	7.30	4,281	22.0	4.18	158
	31-Aug-2017	7.27	4,487	20.8	2.40	209
	30-May-2017	7.09	4,351	20.84	3.24	236.1
	1-Mar-2017	7.46	4,517	20.52	1.41	244.1
	17-Nov-2016	7.33	4,861	21.10	5.71	137.9
29-Aug-2016	7.20	4,658	23.70	1.21	50.5	
27-May-2016	7.38	3,299	20.54	4.18	60.3	
22-Feb-2016	7.27	3,279	19.95	3.49	256.5	
19-Nov-2015	7.69	3,169	19.07	4.15	218.6	
27-Aug-2015	7.52	3,656	22.15	NM	190.9	

**TABLE 2. SUMMARY OF MONITORING WELL GROUNDWATER FIELD PARAMETERS
DONA ANA DAIRIES, DONA ANA COUNTY, NEW MEXICO**

Monitoring Well	Date Measured	pH	SpC (uS/cm)	Temp (°C)	DO (mg/L)	ORP (mV)
833-05	21-Nov-2023	7.21	4,567	23.3	2.60	226
	23-Aug-2023	7.18	4,606	23.7	2.52	147
	3-Jul-2023	7.22	4,618	23.1	1.35	152
	23-Feb-2023	7.20	5,371	21.9	1.25	190
	21-Nov-2022	7.27	5,083	22.3	2.70	208
	18-Aug-2022	7.27	5,466	24.5	2.48	183
	18-May-2022	7.44	5,415	24.0	2.84	188
	10-Mar-2022	7.30	5,440	22.0	2.73	189
	16-Nov-2021	7.49	5,523	23.2	2.30	188
	17-Aug-2021	7.64	5,289	24.6	2.41	91
	19-May-2021	7.51	5,335	23.0	2.64	98
	25-Feb-2021	7.50	5,363	22.2	2.84	148
	19-Nov-2020	7.27	5,270	24.1	2.08	128
	25-Aug-2020	7.57	5,548	24.0	1.35	198
	19-May-2020	7.13	5,225	23.5	1.89	148
	17-Feb-2020	7.23	5,277	22.5	1.65	171
	20-Nov-2019	6.56	5,309	23.0	6.96	259
	15-Aug-2019	6.75	5,580	23.4	1.58	125
	22-May-2019	6.52	5,324	23.4	2.31	290
	5-Mar-2019	6.54	3,394	22.2	NM	159
	26-Nov-2018	6.85	5,411	22.8	1.88	128
	31-Aug-2018	6.79	5,389	23.6	2.68	144
	24-May-2018	6.54	5,271	23.0	2.34	138
	22-Feb-2018	7.39	5,475	22.1	2.81	155
	17-Nov-2017	6.73	5,481	22.1	3.01	97
	31-Aug-2017	6.70	5,659	22.9	2.56	220
	31-May-2017	6.92	5,273	22.69	2.94	199.6
	1-Mar-2017	7.30	5,302	21.26	1.64	249.9
	17-Nov-2016	7.03	5,663	23.59	3.85	128.7
	29-Aug-2016	6.78	5,179	25.10	1.34	4.86
26-May-2016	6.96	4,643	23.52	3.41	58.9	
19-Feb-2016	7.41	4,745	22.59	3.27	208.8	
18-Nov-2015	6.98	4,260	23.40	3.44	190.2	
27-Aug-2015	6.93	3,979	23.52	NM	232.1	

**TABLE 2. SUMMARY OF MONITORING WELL GROUNDWATER FIELD PARAMETERS
DONA ANA DAIRIES, DONA ANA COUNTY, NEW MEXICO**

Monitoring Well	Date Measured	pH	SpC (uS/cm)	Temp (°C)	DO (mg/L)	ORP (mV)
833-06	20-Nov-2023	7.23	4,015	19.5	2.30	244
	21-Aug-2023	7.29	4,038	22.4	2.98	167
	15-May-2023	7.30	4,261	21.4	2.90	103
	21-Feb-2023	7.34	4,231	20.3	2.61	256
	17-Nov-2022	7.28	4,198	19.9	2.38	196
	17-Aug-2022	7.21	4,522	20.9	1.39	167
	16-May-2022	7.36	4,350	23.0	2.94	232
	23-Feb-2022	7.62	4,013	21.2	2.91	118
	15-Nov-2021	7.55	4,410	21.8	2.90	118
	17-Aug-2021	7.19	4,234	21.0	2.07	137
	18-May-2021	7.83	4,348	20.3	2.38	118
	23-Feb-2021	7.63	4,029	20.6	1.23	39
	18-Nov-2020	7.55	4,241	21.2	2.30	140
	24-Aug-2020	7.46	4,603	22.9	1.38	190
	19-May-2020	7.49	4,365	21.9	2.90	247
	17-Feb-2020	7.30	4,057	20.3	2.76	93
	20-Nov-2019	7.90	4,032	20.5	1.62	257
	15-Aug-2019	6.97	4,289	22.0	3.45	120
	23-May-2019	6.29	4,151	21.2	1.59	297
	5-Mar-2019	7.17	2,935	20.3	NM	142
	27-Nov-2018	6.86	4,141	20.0	2.39	164
	4-Sep-2018	7.08	3,542	22.0	1.24	137
	29-May-2018	6.81	3,582	22.2	2.59	102
	22-Feb-2018	7.11	3,935	20.8	3.51	164
	16-Nov-2017	6.82	4,046	22.0	4.39	147
	1-Sep-2017	6.85	4,170	21.0	3.54	160
	31-May-2017	6.84	3,880	21.9	2.31	152.3
	1-Mar-2017	7.38	4,105	21.31	1.36	242.1
	17-Nov-2016	7.29	4,150	21.72	6.35	142.4
	26-Aug-2016	6.65	3,851	21.95	1.87	36.3
27-May-2016	7.07	3,388	20.75	5.74	66.4	
22-Feb-2016	7.75	3,246	20.21	5.36	263.2	
19-Nov-2015	7.32	3,564	19.59	5.36	221.7	
27-Aug-2015	7.26	3,677	23.01	NM	199.7	

**TABLE 2. SUMMARY OF MONITORING WELL GROUNDWATER FIELD PARAMETERS
DONA ANA DAIRIES, DONA ANA COUNTY, NEW MEXICO**

Monitoring Well	Date Measured	pH	SpC (uS/cm)	Temp (°C)	DO (mg/L)	ORP (mV)
833-07	21-Nov-2023	7.22	6,046	22.2	1.46	166
	23-Aug-2023	7.25	6,750	22.5	1.55	161
	16-May-2023	7.20	6,590	22.5	2.64	133
	22-Feb-2023	7.25	5,794	19.4	2.26	219
	18-Nov-2022	7.23	5,932	20.8	1.77	209
	18-Aug-2022	7.20	6,409	22.7	2.55	171
	18-May-2022	7.51	6,171	22.5	2.90	179
	10-Mar-2022	7.38	5,522	21.5	2.44	156
	16-Nov-2021	7.58	5,817	22.1	2.47	182
	18-Aug-2021	7.66	5,538	22.4	2.14	100
	18-May-2021	7.49	5,500	22.8	2.92	169
	24-Feb-2021	7.72	5,320	21.5	2.24	87
	19-Nov-2020	7.15	5,379	22.2	2.94	215
	25-Aug-2020	7.26	5,661	23.5	2.00	185
	19-May-2020	7.38	5,758	22.7	2.78	180
	17-Feb-2020	7.27	5,366	21.5	2.23	124
	20-Nov-2019	6.78	5,340	21.2	7.61	254
	15-Aug-2019	6.91	5,534	22.1	1.23	105
	22-May-2019	6.71	5,492	22.3	1.75	304
	4-Mar-2019	7.04	4,127	20.8	2.09	139
	26-Nov-2018	7.22	5,491	20.5	2.09	133
	31-Aug-2018	7.01	5,586	22.3	1.94	174
	24-May-2018	6.71	5,580	21.7	2.21	140
	22-Feb-2018	7.12	5,608	21.8	2.71	160
	17-Nov-2017	6.88	5,652	21.5	2.17	111
	31-Aug-2017	7.02	5,894	22.3	1.81	240
	30-May-2017	6.86	5,704	21.79	2.25	146.8
	1-Mar-2017	7.44	5,908	21.42	1.69	255.8
	17-Nov-2016	7.21	6,202	22.30	3.52	168.1
	29-Aug-2016	7.02	6,312	25.10	1.87	62.2
27-May-2016	7.03	6,250	22.08	2.19	57.1	
18-Feb-2016	6.68	6,525	24.07	2.30	266.4	
18-Nov-2015	7.01	5,810	21.86	2.02	222.2	
27-Aug-2015	7.07	6,630	22.51	NM	232.2	

**TABLE 2. SUMMARY OF MONITORING WELL GROUNDWATER FIELD PARAMETERS
DONA ANA DAIRIES, DONA ANA COUNTY, NEW MEXICO**

Monitoring Well	Date Measured	pH	SpC (uS/cm)	Temp (°C)	DO (mg/L)	ORP (mV)
833-08	21-Nov-2023	7.19	5,308	21.3	2.47	212
	22-Aug-2023	7.26	5,040	23.7	1.90	134
	16-May-2023	7.41	5,120	22.4	2.04	110
	22-Feb-2023	7.26	5,222	20.5	2.02	223
	18-Nov-2022	7.20	4,614	21.5	2.31	211
	18-Aug-2022	7.23	5,525	22.5	2.44	190
	18-May-2022	7.36	5,713	22.2	2.74	172
	10-Mar-2022	7.24	6,395	20.7	2.55	177
	16-Nov-2021	7.41	5,543	22.0	2.84	172
	18-Aug-2021	7.88	3,683	24.5	2.67	118
	18-May-2021	7.85	5,590	23.0	2.45	130
	24-Feb-2021	7.77	5,438	21.1	2.90	103
	18-Nov-2020	7.20	4,853	21.9	2.14	108
	24-Aug-2020	7.45	4,169	23.8	1.29	138
	19-May-2020	7.27	4,600	24.0	2.61	156
	17-Feb-2020	7.60	4,602	22.1	2.12	115
	20-Nov-2019	6.70	4,451	22.2	2.49	250
	14-Aug-2019	6.93	4,719	23.3	1.40	136
	23-May-2019	6.29	4,567	22.2	2.12	273
	5-Mar-2019	6.98	3,190	20.6	NM	148
	27-Nov-2018	6.89	4,561	20.6	2.71	167
	4-Sep-2018	7.10	4,366	22.7	1.07	140
	24-May-2018	6.54	4,524	23.2	3.17	100
	22-Feb-2018	7.44	4,723	22.2	3.88	148
	17-Nov-2017	7.28	4,892	22.2	4.12	121
	1-Sep-2017	7.02	5,284	21.8	3.03	127
	31-May-2017	6.83	4,910	22.6	2.02	163.4
	1-Mar-2017	7.27	4,896	21.37	2.69	228.6
	17-Nov-2016	7.02	5,660	22.79	6.85	139.1
	29-Aug-2016	7.05	4,300	25.90	2.08	55.3
27-May-2016	7.02	3,480	22.11	5.99	61.6	
19-Feb-2016	6.79	3,422	22.54	3.67	225.3	
18-Nov-2015	7.17	3,067	20.30	5.05	158.7	
27-Aug-2015	7.13	3,599	22.17	NM	222.4	

**TABLE 2. SUMMARY OF MONITORING WELL GROUNDWATER FIELD PARAMETERS
DONA ANA DAIRIES, DONA ANA COUNTY, NEW MEXICO**

Monitoring Well	Date Measured	pH	SpC (uS/cm)	Temp (°C)	DO (mg/L)	ORP (mV)
833-09	27-Nov-2023	7.20	5,252	20.2	1.40	122
	23-Aug-2023	7.22	5,330	21.0	1.42	134
	17-May-2023	7.27	5,911	21.9	2.44	156
	23-Feb-2023	7.24	5,642	20.5	2.44	157
	21-Nov-2022	7.24	6,119	20.8	2.20	181
	18-Aug-2022	7.37	7,003	22.0	2.55	132
	19-May-2022	7.23	6,610	21.6	2.55	202
	10-Mar-2022	7.56	6,018	21.3	1.89	208
	17-Nov-2021	7.30	5,953	20.3	2.80	230
	18-Aug-2021	7.81	6,211	22.0	2.93	116
	19-May-2021	7.70	4,274	21.8	2.69	130
	25-Feb-2021	7.45	4,242	20.6	2.85	103
	19-Nov-2020	7.45	4,292	21.4	2.90	121
	25-Aug-2020	7.77	4,626	25.7	2.03	224
	19-May-2020	7.34	4,651	22.0	2.73	144
	18-Feb-2020	7.45	4,521	20.9	2.83	107
	21-Nov-2019	7.00	4,527	20.0	4.56	283
	14-Aug-2019	7.11	4,764	21.6	0.71	89
	22-May-2019	7.21	4,511	21.0	2.40	297
	4-Mar-2019	7.40	4,259	19.5	2.29	140
	26-Nov-2018	7.02	4,839	20.4	2.61	135
	4-Sep-2018	7.02	4,801	21.0	1.66	182
	24-May-2018	6.85	4,846	21.2	2.58	157
	21-Feb-2018	7.41	4,896	21.8	2.26	151
	16-Nov-2017	7.23	4,685	20.6	2.86	158
	31-Aug-2017	7.11	4,997	20.5	1.43	161
	30-May-2017	7.00	4,859	21.06	2.84	141.2
	28-Feb-2017	7.40	5,026	20.37	1.48	172.5
	17-Nov-2016	7.35	5,118	21.06	2.53	121.1
	26-Aug-2016	7.00	5,060	24.20	1.37	41.1
26-May-2016	7.26	4,718	20.61	1.70	41.6	
19-Feb-2016	8.02	5,601	19.84	1.83	219.5	
18-Nov-2015	7.26	5,356	20.04	1.91	217.2	
27-Aug-2015	7.39	5,341	22.71	NM	214.8	

**TABLE 2. SUMMARY OF MONITORING WELL GROUNDWATER FIELD PARAMETERS
DONA ANA DAIRIES, DONA ANA COUNTY, NEW MEXICO**

Monitoring Well	Date Measured	pH	SpC (uS/cm)	Temp (°C)	DO (mg/L)	ORP (mV)
833-10	27-Nov-2023	7.22	4,235	19.1	1.35	191
	24-Aug-2023	7.20	4,210	19.1	2.38	146
	17-May-2023	7.32	4,289	19.1	2.09	131
	23-Feb-2023	7.30	4,306	18.4	2.63	158
	21-Nov-2022	7.28	4,339	18.7	1.96	165
	19-Aug-2022	7.20	4,341	19.5	2.40	177
	19-May-2022	7.32	4,340	19.8	2.66	176
	28-Feb-2022	7.23	4,356	18.0	2.38	207
	17-Nov-2021	7.76	4,301	18.4	2.38	178
	18-Aug-2021	7.81	4,248	19.8	2.76	101
	19-May-2021	7.37	4,181	20.0	2.49	161
	25-Feb-2021	7.63	4,047	19.0	1.83	108
	19-Nov-2020	7.39	4,071	20.8	1.57	128
	25-Aug-2020	7.30	4,142	21.0	1.43	198
	20-May-2020	7.22	4,180	21.5	2.63	162
	18-Feb-2020	7.51	3,974	19.2	1.89	122
	21-Nov-2019	6.50	3,921	19.7	5.82	235
	14-Aug-2019	7.31	4,002	20.2	0.63	125
	22-May-2019	6.74	3,907	19.3	2.28	307
	4-Mar-2019	7.03	3,406	17.9	2.40	127
	26-Nov-2018	6.92	3,903	18.1	2.24	148
	31-Aug-2018	7.30	3,841	19.1	2.55	169
	24-May-2018	7.41	3,927	19.3	2.89	123
	22-Feb-2018	7.57	3,878	18.6	2.77	150
	16-Nov-2017	7.04	3,899	18.5	3.27	156
	31-Aug-2017	6.98	3,992	19.7	2.36	212
	30-May-2017	6.72	3,623	19.07	1.81	182.8
	1-Mar-2017	7.40	3,988	18.19	1.47	248.6
	17-Nov-2016	7.15	3,764	18.50	0.62	129.9
	26-Aug-2016	7.00	3,856	20.10	1.77	55.6
26-May-2016	7.16	3,609	19.39	2.94	46.7	
19-Feb-2016	7.93	3,617	19.11	2.71	220.8	
18-Nov-2015	7.21	3,600	19.11	2.08	210.6	
27-Aug-2015	7.14	3,861	19.7	NM	231.7	

**TABLE 2. SUMMARY OF MONITORING WELL GROUNDWATER FIELD PARAMETERS
DONA ANA DAIRIES, DONA ANA COUNTY, NEW MEXICO**

Monitoring Well	Date Measured	pH	SpC (uS/cm)	Temp (°C)	DO (mg/L)	ORP (mV)
Sunset/Desert Land Dairy						
257-01	28-Nov-2023	7.18	5,411	19.5	1.44	205
	24-Aug-2023	7.30	5,504	20.9	2.74	115
	17-May-2023	7.29	5,394	20.2	2.28	134
	24-Feb-2023	7.22	5,432	19.7	2.73	148
	22-Nov-2022	7.29	5,470	20.0	1.94	168
	19-Aug-2022	7.28	5,478	19.8	1.78	128
	19-May-2022	7.20	5,520	20.3	1.97	259
	28-Feb-2022	7.48	5,522	19.8	2.15	195
	17-Nov-2021	7.80	5,521	20.8	2.74	226
	19-Aug-2021	7.92	5,476	21.8	2.51	46
	20-May-2021	7.73	5,508	20.1	2.58	150
	25-Feb-2021	7.78	5,377	20.0	2.64	97
	20-Nov-2020	7.70	5,505	21.1	1.73	131
	25-Aug-2020	7.41	5,740	21.0	2.08	182
	26-May-2020	7.76	5,705	20.1	2.34	231
	18-Feb-2020	7.81	5,375	19.5	1.80	135
	21-Nov-2019	6.77	5,461	20.7	1.78	226
	6-Aug-2019	7.16	5,844	20.8	NM	174
	21-May-2019	6.71	5,643	18.7	1.30	292
	1-Mar-2019	7.27	4,790	19.7	1.17	181
	27-Nov-2018	7.52	5,784	20.2	1.76	168
	23-Aug-2018	7.58	5,739	21.2	2.25	146
	23-May-2018	7.14	5,797	19.0	2.36	101
	20-Feb-2018	7.56	5,809	19.9	2.84	146
	16-Nov-2017	7.37	5,800	20.3	2.59	156
	18-Aug-2017	7.58	5,774	20.2	3.49	176
	31-May-2017	6.65	5,255	19.9	1.74	121.4
	2-Mar-2017	7.62	5,357	19.24	1.46	183.3
	16-Nov-2016	7.76	5,484	20.63	2.10	36.7
	25-Aug-2016	7.08	5,297	20.04	3.23	26.1
26-May-2016	7.42	4,809	18.91	3.47	17.2	
22-Feb-2016	7.46	4,942	19.56	2.51	171.8	
19-Nov-2015	7.48	4,943	20.16	2.27	184.9	
28-Aug-2015	7.47	5,032	21.14	NM	189.4	

**TABLE 2. SUMMARY OF MONITORING WELL GROUNDWATER FIELD PARAMETERS
DONA ANA DAIRIES, DONA ANA COUNTY, NEW MEXICO**

Monitoring Well	Date Measured	pH	SpC (uS/cm)	Temp (°C)	DO (mg/L)	ORP (mV)
257-02	28-Nov-2023	7.25	3,818	20.5	2.31	140
	24-Aug-2023	7.36	3,815	21.2	1.08	90
	18-May-2023	7.25	4,242	18.2	2.17	160
	24-Feb-2023	7.35	4,388	18.5	2.01	67
	22-Nov-2022	7.27	4,238	20.7	2.18	215
	19-Aug-2022	7.30	4,270	21.1	1.31	133
	19-May-2022	7.50	4,233	19.8	2.18	150
	28-Feb-2022	7.62	3,607	18.3	2.72	147
	18-Nov-2021	7.80	5,215	20.4	1.73	123
	20-Aug-2021	7.83	3,610	21.1	2.79	184
	19-May-2021	7.63	4,545	23.6	2.90	182
	26-Feb-2021	7.65	4,422	17.7	2.55	126
	20-Nov-2020	7.58	4,431	21.9	2.18	187
	26-Aug-2020	7.58	4,473	21.5	1.51	173
	26-May-2020	7.28	4,560	20.2	2.96	177
	18-Feb-2020	7.43	3,981	19.5	2.94	150
	21-Nov-2019	6.86	3,928	20.8	4.14	246
	6-Aug-2019	7.16	4,009	21.2	NM	198
	21-May-2019	6.49	3,844	17.7	1.19	294
	1-Mar-2019	6.99	3,707	19.0	2.11	169
	27-Nov-2018	7.37	4,017	20.3	2.46	155
	23-Aug-2018	7.29	3,996	21.3	2.46	123
	23-May-2018	6.99	3,969	18.8	2.91	122
	20-Feb-2018	7.48	3,943	18.8	4.23	155
	16-Nov-2017	7.20	3,991	20.9	3.29	117
	18-Aug-2017	7.36	4,326	20.9	4.86	150
	31-May-2017	6.65	3,585	19.37	1.87	151.5
	2-Mar-2017	7.72	3,828	18.45	1.67	231.1
	16-Nov-2016	7.74	4,378	21.28	4.37	85.1
	25-Aug-2016	6.94	3,244	21.03	5.64	42.9
26-May-2016	7.24	3,183	18.32	3.78	84.3	
22-Feb-2016	7.75	2,582	20.01	3.44	142.7	
19-Nov-2015	7.41	4,064	21.09	3.38	204.7	
28-Aug-2015	7.27	3,912	21.30	NM	243.8	
257-03	27-Nov-2023	Unknown Blockage in Well -Parameters Not Collected				
	24-Aug-2023	7.22	2981	21.4	2.35	123
	17-May-2023	Dry				
	23-Feb-2023	Dry				
	22-Nov-2022	7.22	3,940	19.6	2.03	230
	22-Aug-2022	7.19	3,887	24.0	2.03	145
	19-May-2022	Unknown Blockage in Well -Parameters Not Collected				
	28-Feb-2022	Unknown Blockage in Well -Parameters Not Collected				
	18-Nov-2021	Unknown Blockage in Well -Parameters Not Collected				
	20-Aug-2021	7.26	4,124	23.0	2.99	102
	20-May-2021	Insufficient Water-Parameters Not Collected				
	26-Feb-2021	7.48	4,189	17.1	2.87	144
	20-Nov-2020	7.20	4,196	21.4	2.93	190
	26-Aug-2020	7.23	4,444	22.4	1.30	165
	26-May-2020	Dry				
	18-Feb-2020	7.22	4,041	17.8	2.38	121
	21-Nov-2019	6.51	3,901	19.6	3.30	244
	6-Aug-2019	6.80	4,514	23.8	NM	272
	21-May-2019	Dry				
	1-Mar-2019	7.17	4,021	18.9	2.28	153
	27-Nov-2018	7.13	3,954	19.7	2.08	160
	23-Aug-2018	7.14	4,200	22.2	1.89	158
	23-May-2018	7.72	3,323	20.1	2.08	64
	20-Feb-2018	7.18	3,755	17.0	1.89	131
	16-Nov-2017	7.14	3,182	20.2	3.11	141
	18-Aug-2017	7.09	3,943	20.6	2.61	247
	31-May-2017	6.48	3,569	20.51	1.68	130
	2-Mar-2017	7.28	3,164	16.57	1.98	251.7
	16-Nov-2016	7.42	2,952	21.12	3.66	90.8
	25-Aug-2016	6.81	2,786	22.39	1.03	27.2
26-May-2016	Dry					
22-Feb-2016	Insufficient Water-Parameters Not Collected					
19-Nov-2015	Dry					
28-Aug-2015	7.34	3,520	24.08	NM	241.6	

**TABLE 2. SUMMARY OF MONITORING WELL GROUNDWATER FIELD PARAMETERS
DONA ANA DAIRIES, DONA ANA COUNTY, NEW MEXICO**

Monitoring Well	Date Measured	pH	SpC (uS/cm)	Temp (°C)	DO (mg/L)	ORP (mV)
257/260-01	20-Feb-2018	Plugged and Abandoned				
	16-Nov-2017	Could Not Access				
	18-Aug-2017	7.55	4,786	20.60	3.03	-217.0
	31-May-2017	10.01	3,974	20.41	3.65	-194.9
	2-Mar-2017	7.97	3,961	18.11	-0.10	-282.3
	16-Nov-2016	8.95	3,111	20.01	4.10	-172.7
	9-Sep-2016	7.36	2,580	23.10	1.78	NM
	26-May-2016	7.70	3,141	17.96	0.81	-180.0
	22-Feb-2016	7.61	3,755	18.22	0.00	-312.4
	19-Nov-2015	7.90	3,217	19.97	0.98	-97.6
28-Aug-2015	7.66	1,840	21.64	NM	194.4	
Las Cruces Community Farms (Former McAnally Enterprises)						
MW-4	28-Nov-2023	7.27	6,542	21.4	2.55	188
	24-Aug-2023	7.27	5,931	22.9	1.66	107
	18-May-2023	7.28	7,182	22.1	1.66	129
	24-Feb-2023	7.43	6,680	21.2	1.88	109
	22-Nov-2022	7.37	7,172	21.2	2.79	164
	22-Aug-2022	7.38	7,741	22.3	2.66	114
	20-May-2022	7.18	6,393	22.0	2.05	196
	28-Feb-2022	7.38	6,399	21.6	2.30	162
	18-Nov-2021	7.57	5,852	21.1	2.87	121
	20-Aug-2021	7.71	6,360	22.8	2.55	87
	20-May-2021	7.68	6,189	22.2	2.93	106
	26-Feb-2021	7.20	6,790	21.4	2.95	104
	20-Nov-2020	7.58	6,914	22.3	2.83	159
	26-Aug-2020	7.24	7,221	22.4	1.93	144
	26-May-2020	7.33	6,976	22.4	2.91	172
	6-Mar-2020	7.52	7,037	21.7	1.45	179
26-Nov-2019	6.61	7,084	21.1	3.87	71	
SOUTHERN AREA						
Del Oro Dairy						
692-01	24-Feb-2016	Plugged and Abandoned				
	2-Dec-2015	6.95	3,550	20.70	1.43	157.5
	31-Aug-2015	Pump Not Operational-Parameters Not Collected				
692-02	29-Nov-2023	7.25	2,703	22.4	2.02	207
	25-Aug-2023	7.25	2,903	24.3	2.17	129
	18-May-2023	7.29	2,618	23.8	1.90	123
	27-Feb-2023	7.21	2,410	21.1	1.69	161
	22-Aug-2022	7.47	2,061	24.5	1.62	99
	20-May-2022	7.66	1,785	23.7	1.31	186
	1-Mar-2022	7.20	1,782	22.0	1.32	215
	19-Nov-2021	7.10	1,589	22.7	1.20	256
	23-Aug-2021	7.22	1,566	24.6	1.15	99
	20-May-2021	7.79	1,536	25.0	1.97	137
	9-Mar-2021	7.89	1,498	23.1	1.08	214
	23-Nov-2020	7.31	1,499	24.1	1.09	237
	26-Aug-2020	7.51	1,539	25.4	1.10	200
	26-May-2020	7.56	1,561	25.8	1.18	150
	19-Feb-2020	7.70	1,463	23.6	2.71	161
	2-Dec-2019	7.64	1,444	24.4	2.28	207
	15-Aug-2019	7.20	2,001	27.2	2.28	96
	29-May-2019	7.05	1,588	23.4	3.02	231
	7-Mar-2019	6.72	2,692	21.8	2.70	141
	27-Nov-2018	6.60	3,697	21.8	3.11	173
	23-Aug-2018	6.70	3,937	22.8	3.76	125
	30-May-2018	6.29	4,040	21.8	4.28	134
	23-Feb-2018	7.06	4,371	21.7	5.17	160
	30-Nov-2017	6.84	3,882	20.4	6.88	169
	23-Aug-2017	6.83	3,617	22.9	3.10	154
	5-Jun-2017	6.70	2,612	22.06	3.72	179.9
	2-Mar-2017	7.00	3,418	21.09	2.04	233.5
	30-Nov-2016	6.43	4,957	22.45	0.50	151.1
	6-Sep-2016	6.99	4,980	22.50	2.97	NM
	31-May-2016	6.79	4,861	21.60	1.77	53.2
24-Feb-2016	6.49	4,818	20.64	1.46	335.4	
2-Dec-2015	6.90	4,801	20.76	1.61	163.4	
31-Aug-2015	6.72	5,119	22.51	NM	198.1	

**TABLE 2. SUMMARY OF MONITORING WELL GROUNDWATER FIELD PARAMETERS
DONA ANA DAIRIES, DONA ANA COUNTY, NEW MEXICO**

Monitoring Well	Date Measured	pH	SpC (uS/cm)	Temp (°C)	DO (mg/L)	ORP (mV)
692-04	29-Nov-2023	Dry				
	25-Aug-2023					
	18-May-2023					
	27-Feb-2023					
	23-Aug-2022	Insufficient Water-Parameters Not Collected				
	20-May-2022	7.30	4,133	23.2	2.00	198
	1-Mar-2022	7.18	3,530	21.0	2.67	221
	19-Nov-2021	7.12	3,390	20.0	2.59	195
	20-Aug-2021	7.81	3,483	24.5	2.61	74
	20-May-2021	Insufficient Water-Parameters Not Collected				
	9-Mar-2021	7.41	3,104	22.0	2.36	154
	23-Nov-2020	7.52	3,442	21.7	2.49	175
	26-Aug-2020	7.66	3,580	25.2	2.66	193
	26-May-2020	7.63	4,815	24.2	2.91	177
	19-Feb-2020	7.15	3,736	20.1	2.50	202
	2-Dec-2019	6.30	3,423	20.0	1.76	248
	15-Aug-2019	6.78	3,564	22.7	2.03	108
	29-May-2019	Dry				
	7-Mar-2019	Dry				
	27-Nov-2018	Dry				
	23-Aug-2018	Dry				
	30-May-2018	Dry				
	23-Feb-2018	Dry				
	30-Nov-2017	Dry				
	23-Aug-2017	Dry				
	5-Jun-2017	Dry				
	2-Mar-2017	Dry				
	30-Nov-2016	Dry				
	2-Sep-2016	Dry				
	31-May-2016	Dry				
	24-Feb-2016	Dry				
2-Dec-2015	Dry					
31-Aug-2015	Dry					
692-05*	1-Dec-2023	7.20	2,546	20.9	1.94	192
	28-Aug-2023	7.17	2,501	25.2	1.79	159
	23-May-2023	7.26	2,470	22.2	1.80	122
	28-Feb-2023	7.22	2,462	21.3	1.87	180
	23-Aug-2022	7.28	2,510	26.8	1.82	157
	20-May-2022	7.38	2,453	24.6	1.82	237
	2-Mar-2022	7.19	2,444	20.3	1.88	214
	19-Nov-2021	7.30	2,531	22.0	1.90	185
	23-Aug-2021	7.13	2,473	24.4	1.79	136
	21-May-2021	7.66	2,467	23.0	1.85	116
	9-Mar-2021	7.43	2,429	21.9	1.80	132
	23-Nov-2020	7.30	2,382	22.4	1.81	221
	27-Aug-2020	7.36	2,491	23.0	1.88	203
	27-May-2020	7.18	2,488	23.1	1.80	187
	19-Feb-2020	7.68	2,349	19.8	2.33	181
	2-Dec-2019	6.55	2,350	20.2	0.79	205
	16-Aug-2019	7.03	2,442	23.7	1.04	90
	29-May-2019	6.80	2,429	23.9	4.24	254
	14-Mar-2019	6.96	1,787	21.6	4.11	191
	4-Dec-2018	Pump Not Operational-Parameters Not Collected				
	23-Aug-2018	6.97	2,430	24.3	4.11	166
	30-May-2018	Pump Not Operational-Parameters Not Collected				
	23-Feb-2018	Pump Not Operational-Parameters Not Collected				
	30-Nov-2017	7.64	2,457	21.1	5.99	164
	22-Aug-2017	7.40	2,429	23.8	6.00	88
	5-Jun-2017	7.19	2,341	22.41	5.29	187.3
	3-Mar-2017	7.67	2,309	20.53	2.48	202.4
	29-Nov-2016	7.53	2,265	20.70	7.88	104.4
	2-Sep-2016	7.22	2,510	23.20	7.09	NM
	31-May-2016	7.54	2,216	21.44	5.74	63.6
	24-Feb-2016	7.01	2,199	20.55	6.20	196.9
2-Dec-2015	7.58	2,127	18.67	13.45	242.9	
31-Aug-2015	7.92	2,713	31.25	NM	124.7	

**TABLE 2. SUMMARY OF MONITORING WELL GROUNDWATER FIELD PARAMETERS
DONA ANA DAIRIES, DONA ANA COUNTY, NEW MEXICO**

Monitoring Well	Date Measured	pH	SpC (uS/cm)	Temp (°C)	DO (mg/L)	ORP (mV)
692-06	1-Dec-2023	7.28	2,303	20.3	1.76	182
	28-Aug-2023	7.20	2,334	25.5	1.73	178
	23-May-2023	7.29	2,272	24.1	1.73	141
	28-Feb-2023	7.29	2,342	21.1	1.77	238
	23-Aug-2022	7.30	2,312	23.3	1.72	207
	23-May-2022	7.22	2,276	22.4	1.71	185
	2-Mar-2022	7.21	2,288	21.5	1.74	213
	22-Nov-2021	7.30	2,326	21.2	1.76	247
	24-Aug-2021	7.73	2,305	25.3	1.73	52
	21-May-2021	7.65	2,322	21.9	1.71	177
	11-Mar-2021	7.84	2,199	22.1	1.69	171
	24-Nov-2020	7.67	2,276	21.2	1.71	104
	27-Aug-2020	7.50	2,350	23.8	1.73	244
	27-May-2020	7.42	2,431	26.4	1.72	126
	18-Feb-2020	7.60	2,186	23.0	2.60	123
	26-Nov-2019	6.91	2,230	19.7	9.98	184
	15-Aug-2019	7.15	2,311	23.7	2.27	166
	29-May-2019	6.71	2,230	23.6	4.37	293
	7-Mar-2019	6.90	2,260	22.0	4.10	115
	4-Dec-2018	7.07	1,734	18.1	3.81	130
	23-Aug-2018	6.74	2,294	22.4	4.61	202
	30-May-2018	6.64	2,305	23.2	5.11	69
	27-Feb-2018	7.60	2,297	22.6	3.62	113
	30-Nov-2017	7.30	2,319	20.7	4.01	185
	23-Aug-2017	7.17	2,351	22.6	4.27	139
	5-Jun-2017	7.09	2,258	22.45	3.74	123.8
	2-Mar-2017	7.30	2,295	21.69	2.82	251.2
	30-Nov-2016	6.86	2,297	22.49	6.12	242.1
	6-Sep-2016	7.72	2,410	22.00	5.24	NM
	31-May-2016	7.29	2,085	21.69	4.84	79.0
24-Feb-2016	7.16	2,147	20.61	3.78	167.3	
1-Dec-2015	7.31	2,147	20.76	2.17	95.2	
31-Aug-2015	7.44	2,420	25.12	NM	119.7	
692-07*	1-Dec-2023	7.33	2,507	21.1	1.86	153
	29-Aug-2023	7.22	2,493	22.5	1.87	150
	24-May-2023	7.32	2,490	22.5	1.86	141
	28-Feb-2023	7.43	2,537	21.2	1.88	152
	24-Aug-2022	7.26	2,499	22.5	1.86	181
	23-May-2022	7.26	2,505	22.1	1.88	169
	2-Mar-2022	7.30	2,492	20.9	1.88	198
	22-Nov-2021	7.36	2,529	22.1	1.88	110
	24-Aug-2021	7.60	2,571	24.6	1.87	80
	21-May-2021	7.73	2,575	23.5	1.92	170
	11-Mar-2021	7.33	2,450	21.4	1.87	244
	24-Nov-2020	7.52	4,503	21.6	1.44	226
	27-Aug-2020	7.10	2,632	22.5	1.92	194
	27-May-2020	7.33	2,644	24.0	1.95	46
	19-Feb-2020	7.89	2,504	17.1	3.45	156
	26-Nov-2019	7.16	2,597	19.5	4.35	227
	16-Aug-2019	7.51	2,625	24.1	3.75	-51
	29-May-2019	6.99	2,553	22.3	4.61	287
	7-Mar-2019	7.00	2,553	20.6	4.39	111
	4-Dec-2018	7.13	2,585	20.0	4.68	115
	23-Aug-2018	7.38	2,563	24.3	6.23	90
	30-May-2018	7.33	2,602	23.2	7.04	35
	23-Feb-2018	7.67	2,623	20.8	7.26	79
	30-Nov-2017	7.56	2,594	20.3	7.11	116
	22-Aug-2017	7.22	2,586	25.3	5.23	89.0
	5-Jun-2017	7.16	2,549	23.27	5.40	226.4
	3-Mar-2017	7.63	2,496	20.38	3.78	259.5
	29-Nov-2016	7.11	2,504	20.48	8.19	87.6
	2-Sep-2016	7.40	2,680	24.80	7.04	NM
	31-May-2016	7.53	2,440	22.55	3.71	42.5
24-Feb-2016	7.18	2,390	20.66	7.90	165.7	
2-Dec-2015	7.68	2,189	17.55	7.20	245.8	
31-Aug-2015	7.37	2,667	25.70	NM	132.9	

**TABLE 2. SUMMARY OF MONITORING WELL GROUNDWATER FIELD PARAMETERS
DONA ANA DAIRIES, DONA ANA COUNTY, NEW MEXICO**

Monitoring Well	Date Measured	pH	SpC (uS/cm)	Temp (°C)	DO (mg/L)	ORP (mV)
692-08*	4-Dec-2023	7.26	2,251	27.5	1.56	68
	29-Aug-2023	7.23	2,212	28.5	1.57	177
	24-May-2023	7.31	2,177	30.1	1.62	52
	1-Mar-2023	7.29	2,201	25.0	1.63	150
	24-Aug-2022	7.28	2,182	27.8	1.63	-95
	23-May-2022	7.27	2,242	31.1	1.60	277
	2-Mar-2022	7.51	2,222	26.1	1.63	26
	22-Nov-2021	7.81	2,251	27.9	1.62	12
	24-Aug-2021	7.65	2,220	30.1	1.60	59
	21-May-2021	7.77	2,189	23.3	1.64	147
	11-Mar-2021	7.43	2,153	24.2	1.60	152
	24-Nov-2020	7.34	2,111	22.0	1.60	231
	27-Aug-2020	7.25	2,195	24.7	1.60	178
	27-May-2020	7.11	2,205	23.8	1.59	248
	18-Feb-2020	7.52	2,196	22.8	1.20	133
	25-Nov-2019	7.14	2,610	19.1	4.10	224
	16-Aug-2019	6.98	2,188	23.5	2.94	184
	29-May-2019	6.69	2,160	21.8	5.38	264
	7-Mar-2019	6.83	2,194	20.4	5.61	159
	4-Dec-2018	6.67	2,217	19.6	5.94	179
	23-Aug-2018	7.31	2,172	23.2	6.74	159
	30-May-2018	6.97	2,200	23.9	6.92	82
	23-Feb-2018	7.54	2,215	21.0	7.13	143
	30-Nov-2017	7.51	2,160	20.6	6.57	198
	22-Aug-2017	7.55	2,191	24.3	5.09	98
	5-Jun-2017	6.62	2,133	22.68	4.78	110.2
	3-Mar-2017	6.88	2,164	21.09	3.56	249.1
	30-Nov-2016	6.90	2,148	21.44	3.63	368.2
	2-Sep-2016	6.92	2,270	22.80	6.89	NM
	31-May-2016	7.12	2,074	22.73	5.11	48.0
24-Feb-2016	7.27	2,072	21.71	7.27	312.5	
1-Dec-2015	7.30	2,009	20.67	8.14	234.2	
31-Aug-2015	7.25	2,385	23.15	NM	134.7	

**TABLE 2. SUMMARY OF MONITORING WELL GROUNDWATER FIELD PARAMETERS
DONA ANA DAIRIES, DONA ANA COUNTY, NEW MEXICO**

Monitoring Well	Date Measured	pH	SpC (uS/cm)	Temp (°C)	DO (mg/L)	ORP (mV)
692-09*	4-Dec-2023	7.19	2,283	23.1	1.62	189
	28-Aug-2023	7.24	2,258	24.8	1.62	93
	23-May-2023	7.30	2,300	24.0	1.66	147
	28-Feb-2023	7.20	2,281	23.5	1.69	154
	23-Aug-2022	7.23	2,258	24.7	1.56	161
	20-May-2022	7.51	2,264	26.5	1.78	180
	1-Mar-2022	7.59	2,281	22.9	1.89	199
	19-Nov-2021	7.40	2,257	23.4	1.60	146
	23-Aug-2021	7.21	2,245	24.3	1.65	111
	20-May-2021	7.44	2,232	23.8	1.59	184
	9-Mar-2021	7.73	2,200	23.4	1.65	124
	23-Nov-2020	7.40	2,156	23.0	1.64	190
	26-Aug-2020	7.26	2,267	24.0	1.62	237
	27-May-2020	7.30	2,240	23.1	1.67	265
	19-Feb-2020	7.75	2,234	17.6	2.84	191
	2-Dec-2019	7.02	2,151	20.1	1.10	182
	16-Aug-2019	7.14	2,241	23.2	2.32	91
	29-May-2019	6.96	2,149	22.9	5.80	232
	7-Mar-2019	7.04	2,211	22.2	5.89	136
	4-Dec-2018	7.52	2,229	20.1	6.11	132
	23-Aug-2018	7.40	2,172	23.1	5.44	111
	30-May-2018	6.91	2,211	23.0	5.21	127
	23-Feb-2018	7.58	2,211	22.1	4.38	143
	30-Nov-2017	7.32	2,196	22.3	5.75	228
	22-Aug-2017	7.25	2,231	24.0	4.28	104
	5-Jun-2017	7.22	2,163	23.19	5.07	156.4
	3-Mar-2017	7.30	2,240	22.24	3.26	257.8
	30-Nov-2016	7.13	2,221	22.09	6.02	103.1
	2-Sep-2016	7.14	2,310	23.50	6.03	NM
	31-May-2016	7.35	2,106	22.81	4.68	62.3
24-Feb-2016	7.06	2,111	22.18	5.54	208.6	
2-Dec-2015	7.65	2,015	18.78	8.02	155.9	
31-Aug-2015	7.57	2,420	27.64	NM	168.5	
692-10	1-Dec-2023	7.37	2,756	22.1	2.08	224
	29-Aug-2023	7.17	2,773	24.5	2.06	152
	24-May-2023	7.25	2,764	24.2	2.07	123
	1-Mar-2023	7.26	2,797	21.4	2.20	115
Anthony Waste Water Treatment Plant						
MW-1	Aug-2015	Parameters Not Collected Since August 2015				
MW-2	Aug-2015	Parameters Not Collected Since August 2015				
MW-3	Aug-2015	Parameters Not Collected Since August 2015				

**TABLE 2. SUMMARY OF MONITORING WELL GROUNDWATER FIELD PARAMETERS
DONA ANA DAIRIES, DONA ANA COUNTY, NEW MEXICO**

Monitoring Well	Date Measured	pH	SpC (uS/cm)	Temp (°C)	DO (mg/L)	ORP (mV)
ABATEMENT PLAN MONITOR WELLS						
DAD-01	5-Dec-2023	7.20	2,278	23.2	1.81	205
	30-Aug-2023	7.22	2,236	24.8	1.71	130
	25-May-2023	7.25	2,467	24.7	1.71	155
	2-Mar-2023	7.20	3,215	20.9	1.85	132
	1-Dec-2022	7.34	2,431	24.0	1.85	148
	24-Aug-2022	7.43	2,240	25.5	1.76	112
	24-May-2022	7.24	2,507	24.3	1.71	203
	3-Mar-2022	7.19	2,696	24.0	1.85	200
	23-Nov-2021	7.54	2,516	23.9	1.82	118
	25-Aug-2021	7.11	2,330	24.9	1.76	146
	1-Jun-2021	7.19	2,250	24.5	1.71	219
	26-Feb-2021	7.59	2,706	23.5	1.79	132
	30-Nov-2020	7.31	2,401	24.0	1.69	308
	27-Aug-2020	7.43	2,290	25.8	1.56	140
	29-May-2020	7.51	2,149	25.5	1.50	132
	21-Feb-2020	7.08	2,347	23.5	0.21	170
	3-Dec-2019	6.57	2,280	22.5	1.35	193
	19-Aug-2019	7.11	2,146	25.3	2.94	96
	22-May-2019	7.03	2,099	24.8	1.11	288
	5-Mar-2019	7.28	2,352	23.9	1.13	127
	28-Nov-2018	7.11	2,221	23.5	1.31	147
	24-Aug-2018	6.79	2,101	25.3	1.14	222
	31-May-2018	7.20	2,084	24.1	1.36	115
	26-Feb-2018	7.44	2,458	22.8	3.17	129
	20-Nov-2017	7.39	2,414	24.6	5.07	131
	24-Aug-2017	7.30	2,436	25.0	5.57	167
	8-Jun-2017	6.93	2,383	25.27	3.40	206.7
	7-Mar-2017	7.23	2,688	23.27	2.40	217.1
	30-Nov-2016	7.09	2,728	24.10	5.82	239.2
	6-Sep-2016	7.24	2,740	25.30	6.16	NM
2-Jun-2016	7.02	2,521	24.87	6.19	98.6	
25-Feb-2016	6.78	2,785	24.29	3.75	198.6	
23-Nov-2015	7.21	2,636	22.29	4.60	-7.4	
1-Sep-2015	7.28	2,406	24.74	NM	255.7	

**TABLE 2. SUMMARY OF MONITORING WELL GROUNDWATER FIELD PARAMETERS
DONA ANA DAIRIES, DONA ANA COUNTY, NEW MEXICO**

Monitoring Well	Date Measured	pH	SpC (uS/cm)	Temp (°C)	DO (mg/L)	ORP (mV)
DAD-02	6-Dec-2023	7.20	3,313	23.2	2.56	204
	5-Sep-2023	7.19	3,160	24.6	2.45	127
	26-May-2023	7.28	2,750	25.1	1.99	101
	3-Mar-2023	7.31	2,413	23.3	1.84	141
	5-Dec-2022	7.35	2,440	23.1	1.88	173
	26-Aug-2022	7.50	2,348	24.7	1.73	80
	25-May-2022	7.60	2,040	24.5	1.57	146
	16-Mar-2022	7.22	1,856	23.3	1.33	179
	30-Nov-2021	7.83	1,821	23.5	1.30	121
	26-Aug-2021	7.71	1,802	25.3	1.36	153
	3-Jun-2021	7.81	1,807	25.1	1.35	182
	2-Mar-2021	7.86	1,678	23.2	1.22	134
	1-Dec-2020	7.47	1,803	17.3	0.94	167
	28-Aug-2020	7.78	1,896	26.0	1.36	132
	29-May-2020	7.41	1,837	25.1	1.35	107
	21-Feb-2020	7.64	1,770	22.3	0.30	135
	4-Dec-2019	6.83	1,711	22.6	2.15	167
	19-Aug-2019	7.38	1,895	24.3	3.17	97
	22-May-2019	7.14	1,862	24.5	1.23	296
	4-Mar-2019	7.32	2,015	23.2	1.31	136
	28-Nov-2018	7.18	2,258	23.2	1.44	156
	24-Aug-2018	7.10	2,325	24.4	1.63	218
	31-May-2018	7.38	2,412	24.1	2.06	111
	26-Feb-2018	7.51	2,652	23.2	2.47	142
	20-Nov-2017	7.30	2,632	23.3	5.75	166
	24-Aug-2017	7.40	2,510	25.1	5.35	73
	8-Jun-2017	6.91	2,606	24.78	4.78	171.8
	7-Mar-2017	7.42	2,727	23.27	2.96	208.2
	30-Nov-2016	7.20	2,535	22.82	6.93	134.3
	6-Sep-2016	7.83	2,570	24.40	6.78	NM
	2-Jun-2016	7.20	2,454	24.80	5.21	79.4
25-Feb-2016	7.22	2,480	22.99	6.08	203.6	
23-Nov-2015	7.31	2,454	22.81	5.28	95.5	
31-Aug-2015	7.48	2,633	25.05	NM	220.6	
DAD-03	7-Dec-2023	7.23	2,658	21.3	1.93	58
	5-Sep-2023	7.22	2,569	22.5	1.88	35
	26-May-2023	7.31	2,600	21.6	1.28	93
	6-Mar-2023	7.34	2,693	21.3	1.99	134
	5-Dec-2022	7.31	2,656	22.0	1.93	98
	26-Aug-2022	7.42	2,633	22.9	1.95	61
	26-May-2022	7.24	2,658	20.2	1.96	194
	16-Mar-2022	7.15	2,780	20.1	2.09	198
	1-Dec-2021	7.54	2,618	22.0	1.98	85
	26-Aug-2021	7.77	2,961	23.6	2.28	-122
	3-Jun-2021	7.58	2,720	20.9	1.97	192
	1-Dec-2020	7.62	2,404	21.7	1.73	-73
	31-Aug-2020	7.70	2,622	22.9	2.22	140
	1-Jun-2020	7.47	2,557	20.7	1.89	157
	21-Feb-2020	7.63	2,461	20.0	0.29	123
	4-Dec-2019	7.13	2,613	21.5	3.49	-40
	19-Aug-2019	7.30	2,731	22.4	1.49	-28
	22-May-2019	7.16	2,839	20.3	2.53	287
	5-Mar-2019	7.34	2,651	19.8	2.60	149
	28-Nov-2018	7.65	2,700	22.1	3.10	152
	24-Aug-2018	7.39	2,953	22.4	2.56	58
	31-May-2018	6.97	3,152	20.3	2.30	83
	26-Feb-2018	7.63	2,952	20.5	2.11	145
	20-Nov-2017	7.25	3,238	22.8	1.48	121
	24-Aug-2017	7.23	3,259	22.4	1.67	-96
	8-Jun-2017	6.79	3,035	21.24	5.23	-13.6
	7-Mar-2017	7.52	3,727	20.11	1.88	216.7
	30-Nov-2016	7.41	3,983	21.72	5.03	-20.9
	6-Sep-2016	7.36	3,750	23.10	2.32	NM
	2-Jun-2016	7.11	3,397	23.72	2.01	61.9
	25-Feb-2016	7.26	3,160	19.80	0.62	-97.8
23-Nov-2015	7.33	3,365	21.04	1.30	-47.3	
1-Sep-2015	7.37	4,085	23.27	NM	225.8	

**TABLE 2. SUMMARY OF MONITORING WELL GROUNDWATER FIELD PARAMETERS
DONA ANA DAIRIES, DONA ANA COUNTY, NEW MEXICO**

Monitoring Well	Date Measured	pH	SpC (uS/cm)	Temp (°C)	DO (mg/L)	ORP (mV)
DAD-04	7-Dec-2023	7.27	3,260	20.5	2.46	114
	6-Sep-2023	7.18	3,386	21.1	2.60	157
	30-May-2023	Dry				
	6-Mar-2023					
	6-Dec-2022	7.21	3,136	19.0	2.44	182
	31-Aug-2022	7.25	1,334	21.6	1.01	102
	26-May-2022	7.36	1,935	19.4	1.42	187
	16-Mar-2022	7.26	3,629	18.9	2.80	175
	1-Dec-2021	7.78	3,550	20.6	2.72	111
	31-Aug-2021	7.50	3,580	22.1	2.69	140
	3-Jun-2021	7.80	3,555	19.3	2.65	150
	2-Mar-2021	7.92	3,240	18.4	2.48	102
	2-Dec-2020	7.82	3,071	19.4	2.36	146
	31-Aug-2020	7.10	3,180	22.5	2.32	119
	1-Jun-2020	7.35	3,002	20.1	2.16	130
	21-Feb-2020	7.81	2,752	18.1	0.27	46
	4-Dec-2019	7.08	3,000	19.3	2.45	-39
	19-Aug-2019	7.68	2,692	22.8	1.74	-47
	23-May-2019	6.69	2,739	19.0	1.33	213
	5-Mar-2019	7.66	2,701	18.1	1.58	142
	28-Nov-2018	7.53	2,748	19.7	1.86	121
	24-Aug-2018	7.77	2,583	21.0	1.59	25
	31-May-2018	7.43	2,667	20.7	1.20	60
	26-Feb-2018	7.66	2,270	18.4	1.84	83
	20-Nov-2017	8.45	1,429	20.9	3.79	29
	24-Aug-2017	7.45	2,986	21.2	NM	78
	8-Jun-2017	6.84	2,696	21.48	2.64	209.2
	7-Mar-2017	7.80	2,486	19.56	1.80	214.6
	2-Dec-2016	7.60	2,843	20.58	5.46	216.8
	6-Sep-2016	7.75	3,040	22.10	3.57	NM
2-Jun-2016	7.16	3,129	20.67	3.12	39.4	
25-Feb-2016	7.52	2,191	18.39	3.45	84.7	
23-Nov-2015	7.68	2,587	19.50	1.92	-29.6	
1-Sep-2015	7.76	3,591	22.82	NM	164.8	

**TABLE 2. SUMMARY OF MONITORING WELL GROUNDWATER FIELD PARAMETERS
DONA ANA DAIRIES, DONA ANA COUNTY, NEW MEXICO**

Monitoring Well	Date Measured	pH	SpC (uS/cm)	Temp (°C)	DO (mg/L)	ORP (mV)
DAD-05	12-Dec-2023	7.26	1,592	20.1	1.09	102
	11-Sep-2023	7.28	1,266	22.8	1.15	91
	1-Jun-2023	7.27	1,350	19.3	1.05	97
	8-Mar-2023	7.29	1,351	18.4	1.05	100
	8-Dec-2022	7.33	1,305	20.0	0.93	60
	12-Sep-2022	7.25	1,231	21.8	1.04	80
	31-May-2022	7.22	2,294	18.2	1.62	31
	17-Mar-2022	7.40	2,377	17.5	1.75	81
	6-Dec-2021	7.20	2,564	19.0	1.84	-79
	2-Sep-2021	7.58	3,147	21.9	2.32	157
	7-Jun-2021	7.64	2,640	19.2	1.32	92
	4-Mar-2021	7.84	2,231	17.1	1.53	156
	2-Dec-2020	7.65	2,210	19.3	1.93	168
	31-Aug-2020	7.68	1,590	23.0	1.15	91
	1-Jun-2020	7.49	2,381	19.9	1.51	106
	21-Feb-2020	7.66	2,603	17.3	0.25	87
	5-Dec-2019	7.31	2,334	19.6	2.50	137
	22-Aug-2019	7.53	2,838	20.2	2.88	85
	23-May-2019	6.84	3,379	17.1	2.06	286
	5-Mar-2019	7.57	2,898	16.8	2.51	147
	29-Nov-2018	7.51	3,911	19.9	1.28	172
	24-Aug-2018	7.45	4,335	20.0	2.91	90
	31-May-2018	7.00	4,244	15.8	3.45	60
	26-Feb-2018	7.23	4,209	16.7	4.67	112
	27-Nov-2017	7.28	4,252	20.1	1.62	138
	25-Aug-2017	7.53	2,517	20.6	3.72	187
	8-Jun-2017	6.53	3,839	17.82	2.77	38.3
	7-Mar-2017	7.41	2,997	17.25	2.27	231.3
	2-Dec-2016	7.09	3,954	19.60	1.81	153.6
	6-Sep-2016	7.20	4,040	19.50	2.53	NM
2-Jun-2016	7.09	3,542	17.60	2.87	66.2	
25-Feb-2016	7.12	3,494	17.20	1.47	167.5	
23-Nov-2015	7.29	3,106	19.79	1.71	29.8	
1-Sep-2015	7.52	2,935	22.60	NM	101.4	

**TABLE 2. SUMMARY OF MONITORING WELL GROUNDWATER FIELD PARAMETERS
DONA ANA DAIRIES, DONA ANA COUNTY, NEW MEXICO**

Monitoring Well	Date Measured	pH	SpC (uS/cm)	Temp (°C)	DO (mg/L)	ORP (mV)
DAD-06	4-Nov-2022	Plugged and Abandoned				
	13-Sep-2022	Dry Since Septemeber 2022				
	27-May-2022	Dry				
	22-Mar-2022	Dry				
	1-Dec-2021	Dry				
	31-Aug-2021	Dry				
	4-Jun-2021	Dry				
	3-Mar-2021	Dry				
	1-Dec-2020	Dry				
	31-Aug-2020	Dry				
	1-Jun-2020	Dry				
	9-Mar-2020	Dry				
	4-Dec-2019	Dry				
	22-Aug-2019	Dry				
	28-May-2019	Dry				
	14-Mar-2019	Dry				
	4-Dec-2018	Dry				
	31-Aug-2018	Dry				
	4-Jun-2018	Dry				
	28-Feb-2018	Dry				
	28-Nov-2017	Dry				
	29-Aug-2017	Dry				
	12-Jun-2017	Dry				
	13-Mar-2017	Dry				
	6-Dec-2016	Dry				
	8-Sep-2016	Dry				
	6-Jun-2016	Dry				
	25-Feb-2016	Dry				
	23-Nov-2015	Dry				
	1-Sep-2015	Dry				

**TABLE 2. SUMMARY OF MONITORING WELL GROUNDWATER FIELD PARAMETERS
DONA ANA DAIRIES, DONA ANA COUNTY, NEW MEXICO**

Monitoring Well	Date Measured	pH	SpC (uS/cm)	Temp (°C)	DO (mg/L)	ORP (mV)
DAD-06R	8-Dec-2023	7.38	2,091	23.3	1.22	103
	6-Sep-2023	7.24	1,123	26.1	1.20	131
	30-May-2023	7.23	1,315	27.0	1.25	79
	7-Mar-2023	7.26	1,052	23.2	1.10	131
	6-Dec-2022	7.46	1,108	23.8	0.75	140
DAD-07	13-Dec-2023	7.18	4,560	22.3	2.34	187
	6-Sep-2023	7.24	4,036	27.2	2.28	133
	5-Jun-2023	7.28	3,698	25.6	2.61	124
	7-Mar-2023	7.27	3,312	24.2	2.19	123
	7-Dec-2022	7.22	3,138	24.1	2.14	168
	13-Sep-2022	7.20	2,906	25.0	2.02	126
	1-Jun-2022	7.22	2,976	24.5	2.05	184
	22-Mar-2022	7.26	3,086	22.0	2.16	163
	7-Dec-2021	7.28	3,213	24.0	2.25	115
	1-Sep-2021	7.20	5,616	25.2	2.44	120
	4-Jun-2021	7.28	3,539	24.9	2.56	172
	3-Mar-2021	7.31	3,596	24.1	2.76	123
	4-Dec-2020	7.18	3,634	22.8	2.88	203
	3-Sep-2020	7.31	3,773	24.8	2.82	171
	3-Jun-2020	7.50	3,471	25.6	2.63	140
	25-Feb-2020	6.93	3,220	23.0	0.50	181
	5-Dec-2019	6.41	3,142	23.2	1.91	136
	21-Aug-2019	6.84	3,261	25.6	3.19	224
	24-May-2019	6.51	3,153	24.4	2.44	308
	8-Mar-2019	6.71	2,534	24.1	1.34	162
	29-Nov-2018	6.86	3,070	23.9	1.64	148
	27-Aug-2018	6.93	3,138	24.9	2.20	236
	1-Jun-2018	6.75	3,341	25.3	3.11	151
	27-Feb-2018	6.64	3,823	24.2	3.61	156
	28-Nov-2017	7.02	3,636	24.4	4.16	149
	28-Aug-2017	6.86	3,270	24.7	NM	190
	6-Jun-2017	6.73	3,048	24.96	2.80	196.7
	10-Mar-2017	6.92	2,948	24.40	3.24	196.4
	5-Dec-2016	6.93	2,847	23.78	5.11	215.0
	7-Sep-2016	7.12	3,160	24.80	5.78	NM
8-Jun-2016	6.79	2,985	24.84	4.60	239.2	
1-Mar-2016	7.00	3,037	24.36	4.23	208.7	
30-Nov-2015	7.09	3,088	21.59	4.65	257.1	
1-Sep-2015	7.37	3,569	26.31	NM	148.2	

**TABLE 2. SUMMARY OF MONITORING WELL GROUNDWATER FIELD PARAMETERS
DONA ANA DAIRIES, DONA ANA COUNTY, NEW MEXICO**

Monitoring Well	Date Measured	pH	SpC (uS/cm)	Temp (°C)	DO (mg/L)	ORP (mV)
DAD-08	13-Dec-2023	7.27	6,356	20.6	2.41	115
	12-Sep-2023	7.23	6,618	21.3	2.35	142
	5-Jun-2023	7.24	6,590	22.4	2.22	140
	8-Mar-2023	7.38	6,558	21.7	2.92	86
	8-Dec-2022	7.37	6,354	21.5	2.95	135
	12-Sep-2022	7.30	6,947	22.7	2.85	62
	31-May-2022	7.41	7,122	22.5	2.97	116
	18-Mar-2022	7.20	6,936	20.6	2.51	189
	6-Dec-2021	7.49	6,815	21.2	2.75	68
	2-Sep-2021	7.46	6,947	22.8	2.94	208
	7-Jun-2021	7.67	7,471	22.4	2.71	104
	3-Mar-2021	7.68	7,165	21.3	2.00	103
	3-Dec-2020	7.25	6,949	20.8	2.90	182
	2-Sep-2020	7.43	7,396	22.8	2.51	131
	2-Jun-2020	7.18	7,059	23.9	2.48	184
	21-Feb-2020	7.36	7,094	20.4	0.44	81
	4-Dec-2019	6.57	7,007	20.3	6.32	167
	19-Aug-2019	6.98	7,181	22.1	2.93	72
	23-May-2019	6.38	7,905	21.9	2.21	288
	5-Mar-2019	7.25	3,765	20.6	1.84	158
	29-Nov-2018	7.50	6,136	20.8	2.11	159
	24-Aug-2018	6.99	7,829	22.1	3.11	128
	31-May-2018	6.73	7,682	21.1	3.52	109
	26-Feb-2018	6.97	7,135	21.1	3.24	126
	27-Nov-2017	7.27	6,587	21.2	2.87	149
	25-Aug-2017	7.07	6,396	21.9	3.05	243
	8-Jun-2017	6.50	7,029	21.64	3.83	59.4
	7-Mar-2017	7.34	7,737	20.57	2.34	237.7
	2-Dec-2016	7.02	8,153	20.74	4.32	138.9
	6-Sep-2016	7.28	8,410	21.80	4.98	NM
2-Jun-2016	7.06	7,862	21.51	4.97	78.8	
25-Feb-2016	7.07	7,896	20.38	4.79	177.3	
23-Nov-2015	7.20	8,036	26.21	3.73	95.1	
1-Sep-2015	7.54	8,449	23.03	NM	181.8	

**TABLE 2. SUMMARY OF MONITORING WELL GROUNDWATER FIELD PARAMETERS
DONA ANA DAIRIES, DONA ANA COUNTY, NEW MEXICO**

Monitoring Well	Date Measured	pH	SpC (uS/cm)	Temp (°C)	DO (mg/L)	ORP (mV)
DAD-09	14-Dec-2023	7.23	2,817	22.5	1.70	162
	13-Sep-2023	7.24	2,735	23.7	1.50	135
	6-Jun-2023	7.23	2,964	23.9	2.06	150
	9-Mar-2023	7.39	3,083	22.5	2.19	126
	9-Dec-2022	7.29	3,043	22.6	2.23	147
	13-Sep-2022	7.22	3,020	24.0	2.28	116
	1-Jun-2022	7.20	3,058	24.1	2.30	211
	22-Mar-2022	7.63	2,881	22.0	1.81	159
	7-Dec-2021	7.66	1,938	22.4	887.2	108
	3-Sep-2021	7.58	1,143	24.6	1.81	220
	28-May-2021	7.50	2,988	24.0	2.43	165
	8-Mar-2021	7.38	2,954	21.9	2.33	148
	7-Dec-2020	7.49	2,834	21.8	2.51	181
	3-Sep-2020	7.52	2,205	26.3	1.06	157
	3-Jun-2020	7.41	3,651	24.4	2.53	170
	19-Feb-2020	7.13	2,836	22.1	2.03	171
	6-Dec-2019	6.82	1,262	22.4	1.69	255
	21-Aug-2019	6.84	4,602	23.8	3.43	122
	24-May-2019	6.15	4,669	23.5	1.71	282
	7-Mar-2019	6.91	2,609	23.0	1.56	137
	30-Nov-2018	6.80	3,429	22.0	1.34	151
	27-Aug-2018	6.06	4,046	24.1	1.59	217
	4-Jun-2018	6.23	4,601	22.7	1.34	160
	28-Feb-2018	6.61	3,836	22.2	1.67	183
	28-Nov-2017	6.98	3,372	23.0	2.77	193
	23-Aug-2017	6.92	3,070	23.8	4.98	129
	9-Jun-2017	6.57	3,975	23.74	2.73	65.9
	10-Mar-2017	6.72	3,865	22.49	1.01	197.9
	6-Dec-2016	7.20	3,618	21.40	3.70	326.0
	7-Sep-2016	6.93	3,430	24.40	2.41	NM
6-Jun-2016	6.64	3,142	23.46	2.49	271.9	
29-Feb-2016	6.90	2,888	22.47	2.55	216.2	
23-Nov-2015	7.01	2,837	21.88	2.08	127.2	
2-Sep-2015	7.19	3,006	24.32	NM	243.3	

**TABLE 2. SUMMARY OF MONITORING WELL GROUNDWATER FIELD PARAMETERS
DONA ANA DAIRIES, DONA ANA COUNTY, NEW MEXICO**

Monitoring Well	Date Measured	pH	SpC (uS/cm)	Temp (°C)	DO (mg/L)	ORP (mV)
DAD-10	14-Dec-2023	7.17	2,163	19.4	1.62	185
	13-Sep-2023	7.17	2,138	20.8	1.59	125
	9-Jun-2023	7.22	2,151	21.8	1.60	136
	10-Mar-2023	7.37	2,165	21.0	1.61	234
	9-Dec-2022	7.29	2,193	18.5	1.63	179
	14-Sep-2022	7.23	2,143	22.6	1.59	113
	2-Jun-2022	7.43	2,154	21.9	1.59	198
	23-Mar-2022	7.50	2,162	18.7	1.66	191
	8-Dec-2021	7.43	2,174	20.6	1.63	169
	24-Aug-2021	7.80	2,153	23.3	1.57	99
	28-May-2021	7.15	2,167	21.2	1.73	153
	8-Mar-2021	7.73	2,117	21.2	1.59	164
	24-Nov-2020	7.87	2,127	20.5	1.59	149
	3-Sep-2020	7.58	2,192	22.9	1.57	197
	4-Jun-2020	7.29	2,197	22.0	1.63	254
	19-Feb-2020	7.52	2,444	19.0	2.13	175
	2-Dec-2019	6.79	2,077	19.8	1.85	151
	22-Aug-2019	7.18	2,209	21.3	1.86	196
	24-May-2019	6.71	2,160	21.6	2.36	302
	11-Mar-2019	7.34	2,180	20.8	1.09	154
	30-Nov-2018	6.87	2,318	19.8	1.61	175
	27-Aug-2018	7.24	2,206	22.1	1.31	229
	4-Jun-2018	6.72	2,294	20.8	3.39	138
	28-Feb-2018	7.03	2,415	20.7	3.88	167
	28-Nov-2017	7.35	2,497	21.9	2.77	166
	25-Aug-2017	7.08	2,544	22.5	3.14	197
	9-Jun-2017	6.59	2,411	21.96	4.55	222.6
	8-Mar-2017	7.28	2,414	21.94	2.21	213.2
	6-Dec-2016	7.52	2,404	19.76	2.85	260.7
	7-Sep-2016	7.47	2,620	22.70	2.81	NM
6-Jun-2016	7.07	2,301	22.38	2.17	269.5	
29-Feb-2016	7.28	2,364	21.64	3.63	229.0	
24-Nov-2015	7.37	2,259	21.32	2.13	81.6	
3-Sep-2015	7.27	2,421	22.08	NM	241.2	

**TABLE 2. SUMMARY OF MONITORING WELL GROUNDWATER FIELD PARAMETERS
DONA ANA DAIRIES, DONA ANA COUNTY, NEW MEXICO**

Monitoring Well	Date Measured	pH	SpC (uS/cm)	Temp (°C)	DO (mg/L)	ORP (mV)
DAD-11 Vertical Delineation	6-Dec-2023	7.20	5,370	20.7	2.83	194
	31-Aug-2023	7.27	5,073	22.0	2.68	142
	25-May-2023	7.22	4,778	22.1	1.63	131
	3-Mar-2023	7.22	4,619	19.6	2.72	134
	2-Dec-2022	7.25	4,388	21.3	2.43	157
	25-Aug-2022	7.30	4,339	22.6	1.34	120
	25-May-2022	7.20	4,306	21.1	2.87	208
	15-Mar-2022	7.19	4,333	20.7	2.90	153
	30-Nov-2021	7.60	4,320	22.9	2.88	159
	25-Aug-2021	7.74	4,263	25.2	2.60	201
	1-Jun-2021	7.78	4,292	22.5	2.59	148
	1-Mar-2021	7.68	4,058	21.0	2.93	129
	1-Dec-2020	7.18	4,015	20.2	1.52	168
	28-Aug-2020	7.78	4,212	22.5	1.88	-113
	29-May-2020	7.45	4,231	21.8	2.93	148
	26-Feb-2020	7.67	3,989	20.0	0.47	131
	12-Dec-2019	6.59	3,885	21.0	3.05	255
	20-Aug-2019	7.00	4,409	22.4	2.10	129
	28-May-2019	6.69	4,318	21.5	1.44	291
	11-Mar-2019	7.22	3,059	21.4	1.80	171
	3-Dec-2018	6.76	4,309	21.6	1.80	164
	29-Aug-2018	7.07	4,476	23.1	1.75	265
	31-May-2018	6.59	4,493	23.6	3.41	128
	28-Feb-2018	7.59	3,902	23.0	3.28	151
	29-Nov-2017	7.50	2,972	22.5	3.77	180
	29-Aug-2017	7.04	3,868	21.6	1.68	245
	6-Jun-2017	6.62	4,544	22.51	1.94	197.6
	8-Mar-2017	7.11	5,351	22.03	2.60	227.8
	2-Dec-2016	7.26	4,183	22.13	1.53	126.7
	8-Sep-2016	7.18	6,250	22.40	2.26	NM
	8-Jun-2016	6.60	5,892	22.05	1.24	248.7
29-Feb-2016	7.19	4,518	20.64	5.13	367.9	
24-Nov-2015	7.22	6,105	22.14	1.25	151.2	
1-Sep-2015	6.94	4,712	23.60	NM	246.7	
DAD-12 Vertical Delineation	5-Dec-2023	7.18	4,690	20.4	1.36	207
	30-Aug-2023	7.25	4,669	23.1	2.29	123
	25-May-2023	7.24	4,656	22.6	2.33	148
	2-Mar-2023	7.24	4,711	19.5	2.90	179
	1-Dec-2022	7.28	4,869	21.3	2.33	155
	25-Aug-2022	7.25	4,861	22.8	1.88	178
	24-May-2022	7.25	4,961	22.0	2.48	252
	3-Mar-2022	7.30	4,962	22.0	2.91	198
	23-Nov-2021	7.20	5,149	21.3	2.47	143
	25-Aug-2021	7.32	5,436	22.4	2.26	171
	1-Jun-2021	7.28	5,446	22.1	2.85	179
	26-Feb-2021	7.74	5,256	20.8	2.15	140
	30-Nov-2020	7.28	5,275	21.0	2.05	150
	27-Aug-2020	7.77	5,466	25.5	2.31	197
	29-May-2020	7.43	5,572	23.3	2.63	165
	26-Feb-2020	7.35	5,306	21.0	0.22	156
	3-Dec-2019	6.55	5,258	20.4	2.80	163
	20-Aug-2019	6.80	5,755	22.8	1.30	198
	28-May-2019	6.24	5,551	22.7	3.20	256
	11-Mar-2019	7.02	3,117	21.5	2.21	168
	3-Dec-2018	6.58	4,898	22.0	2.35	163
	28-Aug-2018	6.93	5,561	22.8	2.03	211
	1-Jun-2018	6.70	5,726	22.9	4.62	148
	27-Feb-2018	7.07	5,851	23.0	5.17	131
	29-Nov-2017	7.07	5,856	22.3	3.03	172
	28-Aug-2017	6.92	5,429	22.6	3.67	191
	12-Jun-2017	7.17	4,221	22.69	3.62	192.5
	8-Mar-2017	6.90	5,893	22.19	1.77	207.6
	5-Dec-2016	6.94	5,930	23.21	0.75	182.5
	8-Sep-2016	7.20	4,610	22.10	1.69	NM
	8-Jun-2016	6.79	4,216	22.18	1.64	249.1
29-Feb-2016	6.97	4,222	21.11	1.84	257.0	
24-Nov-2015	7.20	4,205	22.34	1.67	106.3	

**TABLE 2. SUMMARY OF MONITORING WELL GROUNDWATER FIELD PARAMETERS
DONA ANA DAIRIES, DONA ANA COUNTY, NEW MEXICO**

Monitoring Well	Date Measured	pH	SpC (uS/cm)	Temp (°C)	DO (mg/L)	ORP (mV)
DAD-13	5-Dec-2023	7.20	4,175	23.3	2.07	170
	30-Aug-2023	7.26	3,371	24.9	2.94	113
	25-May-2023	7.42	3,550	25.4	2.81	127
	2-Mar-2023	7.22	3,684	21.8	2.72	131
	2-Dec-2022	7.18	3,747	22.3	2.82	187
	25-Aug-2022	7.21	3,756	24.0	2.82	137
	24-May-2022	7.31	3,656	23.7	2.75	168
	3-Mar-2022	7.25	3,880	23.6	2.93	146
	23-Nov-2021	7.36	3,524	23.1	2.65	149
	25-Aug-2021	7.45	3,333	24.5	2.47	173
	1-Sep-2015	6.99	4,285	22.76	NM	261.4
	1-Jun-2021	7.29	3,303	24.6	2.46	151
	1-Mar-2021	7.20	3,200	22.2	2.46	222
	30-Nov-2020	7.05	2,978	21.7	2.32	167
	28-Aug-2020	7.48	3,538	24.4	2.73	219
	29-May-2020	7.50	3,540	25.0	2.61	125
	26-Feb-2020	7.55	3,100	22.7	0.50	128
	3-Dec-2019	6.48	2,966	20.8	4.82	183
	20-Aug-2019	6.86	3,547	24.5	1.91	148
	23-May-2019	6.54	3,281	23.8	1.28	302
	8-Mar-2019	6.73	2,580	22.2	1.68	168
	28-Nov-2018	7.22	3,061	22.8	2.29	149
	27-Aug-2018	6.89	2,838	23.7	2.06	278
	31-May-2018	6.50	4,023	22.7	1.77	132
	27-Feb-2018	6.99	2,522	22.2	3.11	121
	27-Nov-2017	7.00	2,726	23.0	2.24	197
	24-Aug-2017	6.77	3,593	23.4	3.06	236
	12-Jun-2017	7.37	3,773	23.87	4.76	120.9
	8-Mar-2017	6.86	3,350	23.15	1.95	209.7
	5-Dec-2016	7.09	3,429	20.09	5.61	421.1
	8-Sep-2016	6.88	3,620	24.20	2.80	NM
	2-Jun-2016	6.77	3,443	23.46	2.60	88.0
25-Feb-2016	6.91	3,407	22.77	1.49	210.9	
DAD-14	5-Dec-2023	7.30	6,476	22.4	2.42	199
	31-Aug-2023	7.30	6,333	22.2	2.77	118
	26-May-2023	7.28	5,906	21.8	2.94	149
	2-Mar-2023	7.29	5,574	19.7	2.72	207
	2-Dec-2022	7.32	5,226	21.4	2.04	161
	26-Aug-2022	7.24	4,378	22.2	1.88	134
	24-May-2022	7.33	4,185	21.6	2.33	168
	15-Mar-2022	7.60	4,159	21.2	NM	NM
	23-Nov-2021	7.68	4,185	21.4	2.79	149
	26-Aug-2021	7.58	4,295	22.7	2.60	142
	24-Nov-2015	7.01	3,306	22.97	1.54	126.5
	1-Sep-2015	7.31	3,595	24.61	NM	226.0
	3-Jun-2021	7.23	4,231	21.2	2.78	223
	2-Mar-2021	7.79	4,158	20.6	2.33	100
	1-Dec-2020	7.43	4,184	20.7	1.33	155
	28-Aug-2020	7.40	4,530	23.8	2.08	62
	29-May-2020	7.32	4,565	22.9	2.43	127
	26-Feb-2020	7.55	4,463	20.5	0.42	109
	3-Dec-2019	6.86	4,601	20.6	2.60	176
	20-Aug-2019	7.24	4,907	22.3	1.24	159
	24-May-2019	6.76	4,954	21.1	2.88	304
	8-Mar-2019	7.14	3,439	21.1	1.70	162
	28-Nov-2018	7.35	5,061	20.7	2.58	165
	29-Aug-2018	7.36	5,042	21.3	2.27	173
	31-May-2018	7.05	5,198	20.6	2.12	136
	26-Feb-2018	7.59	5,296	20.8	4.07	153
	27-Nov-2017	7.49	5,366	21.4	2.19	183
	28-Aug-2017	7.31	5,459	21.8	4.52	215
	6-Jun-2017	6.61	5,433	21.54	2.11	117.6
	8-Mar-2017	7.45	5,547	20.79	2.59	199.2
	2-Dec-2016	7.34	5,493	20.33	1.77	137.5
	8-Sep-2016	7.45	5,850	21.60	2.81	NM
2-Jun-2016	7.20	5,487	20.75	4.09	85.4	
29-Feb-2016	7.47	5,231	20.00	2.60	265.3	

**TABLE 2. SUMMARY OF MONITORING WELL GROUNDWATER FIELD PARAMETERS
DONA ANA DAIRIES, DONA ANA COUNTY, NEW MEXICO**

Monitoring Well	Date Measured	pH	SpC (uS/cm)	Temp (°C)	DO (mg/L)	ORP (mV)
DAD-15	8-Dec-2023	7.26	3,821	23.4	2.71	173
	5-Sep-2023	7.20	3,977	24.9	2.82	86
	30-May-2023	7.31	3,488	25.3	2.68	140
	6-Mar-2023	7.22	3,838	24.1	2.86	128
	5-Dec-2022	7.27	3,808	23.8	2.70	140
	31-Aug-2022	7.23	3,756	24.1	2.91	76
	26-May-2022	7.28	3,920	24.6	2.49	194
	23-Mar-2022	7.27	3,779	23.4	2.78	187
	2-Dec-2021	7.60	3,712	22.8	2.71	49
	31-Aug-2021	7.23	3,565	26.2	2.49	182
	24-Nov-2015	7.56	5,242	21.02	2.60	139.1
	1-Sep-2015	7.42	5,006	21.43	NM	247.2
	4-Jun-2021	7.68	3,274	23.7	2.34	80
	4-Mar-2021	7.62	3,360	23.3	2.34	198
	4-Dec-2020	7.34	3,354	23.2	2.53	261
	3-Sep-2020	7.30	3,294	24.7	2.60	186
	1-Jun-2020	7.34	3,226	24.8	2.45	117
	26-Feb-2020	7.44	3,030	23.9	0.93	115
	5-Dec-2019	6.72	3,019	22.0	1.36	187
	21-Aug-2019	6.80	3,390	25.0	4.24	214
	24-May-2019	6.60	3,291	23.4	2.28	275
	8-Mar-2019	7.09	2,723	23.4	1.04	149
	30-Nov-2018	7.07	2,820	22.0	2.21	176
	27-Aug-2018	6.94	3,139	25.5	2.44	245
	1-Jun-2018	6.85	3,070	24.1	2.25	148
	27-Feb-2018	7.32	3,015	22.1	2.81	113
	20-Nov-2017	7.11	2,906	23.9	3.36	129
	28-Aug-2017	7.03	2,890	24.3	2.72	167
	9-Jun-2017	6.85	2,869	24.42	3.63	23.7
	13-Mar-2017	6.99	2,829	22.47	3.01	236.5
5-Dec-2016	7.06	2,831	22.56	5.56	186.2	
7-Sep-2016	7.64	2,830	24.10	4.73	NM	
8-Jun-2016	6.96	2,762	25.21	2.12	223.8	
29-Feb-2016	7.07	2,738	22.66	4.68	251.2	

**TABLE 2. SUMMARY OF MONITORING WELL GROUNDWATER FIELD PARAMETERS
DONA ANA DAIRIES, DONA ANA COUNTY, NEW MEXICO**

Monitoring Well	Date Measured	pH	SpC (uS/cm)	Temp (°C)	DO (mg/L)	ORP (mV)
DAD-16	7-Dec-2023	7.34	2,488	19.6	1.92	114
	6-Sep-2023	7.28	2,596	19.2	1.94	136
	30-May-2023	7.21	2,806	20.7	2.09	149
	6-Mar-2023	7.34	2,970	19.2	2.22	208
	6-Dec-2022	7.36	2,833	19.3	2.16	172
	31-Aug-2022	7.29	3,235	19.9	2.41	90
	26-May-2022	7.33	3,466	19.5	2.59	175
	16-Mar-2022	7.47	3,326	18.5	2.55	157
	1-Dec-2021	7.84	3,338	18.5	2.55	106
	31-Aug-2021	7.58	3,454	20.1	2.63	126
	24-Nov-2015	7.22	2,630	22.17	3.36	171.1
	3-Sep-2015	7.14	2,702	23.39	NM	240.8
	4-Jun-2021	7.70	3,508	18.1	2.67	163
	3-Mar-2021	7.40	3,139	18.9	2.42	133
	2-Dec-2020	7.70	3,310	17.4	2.59	146
	31-Aug-2020	7.40	3,494	20.1	2.61	97
	1-Jun-2020	7.18	3,313	20.5	2.35	115
	25-Feb-2020	7.34	2,946	17.5	0.19	99
	5-Dec-2019	7.04	3,197	18.7	2.36	150
	20-Aug-2019	7.28	3,297	19.6	0.92	164
	23-May-2019	6.70	3,048	18.3	1.88	255
	8-Mar-2019	7.23	2,760	18.5	1.59	155
	29-Nov-2018	7.28	3,446	18.6	1.30	173
	27-Aug-2018	7.21	3,611	19.8	3.17	237
	1-Jun-2018	7.06	3,721	18.4	2.30	156
	27-Feb-2018	7.36	2,897	20.0	1.96	134
	28-Nov-2017	7.70	3,501	19.3	3.21	88
	28-Aug-2017	7.20	4,416	20.0	3.82	184
	6-Jun-2017	6.67	3,672	18.94	2.86	187.6
	8-Mar-2017	7.43	3,679	19.15	2.27	218.1
2-Dec-2016	7.42	2,551	19.22	2.29	145.9	
7-Sep-2016	7.36	4,590	19.70	2.40	NM	
6-Jun-2016	6.99	2,448	18.73	2.45	229.3	
29-Feb-2016	7.33	3,106	18.49	2.60	204.9	

**TABLE 2. SUMMARY OF MONITORING WELL GROUNDWATER FIELD PARAMETERS
DONA ANA DAIRIES, DONA ANA COUNTY, NEW MEXICO**

Monitoring Well	Date Measured	pH	SpC (uS/cm)	Temp (°C)	DO (mg/L)	ORP (mV)
DAD-17	12-Dec-2023	7.25	1,162	21.7	1.20	169
	11-Sep-2023	7.26	1,244	21.7	1.02	119
	1-Jun-2023	7.25	1,528	20.7	1.10	105
	8-Mar-2023	7.19	1,513	19.8	1.06	137
	8-Dec-2022	7.25	1,474	20.0	1.05	190
	1-Sep-2022	7.32	1,346	20.8	0.98	71
	31-May-2022	7.25	1,450	20.5	1.05	172
	17-Mar-2022	7.41	1,345	20.1	1.16	154
	6-Dec-2021	7.18	1,232	19.7	1.05	168
	2-Sep-2021	7.20	1,941	22.2	1.06	102
	30-Nov-2015	7.34	3,424	18.55	2.81	229.8
	2-Sep-2015	7.35	2,861	20.26	NM	251.4
	7-Jun-2021	7.77	1,510	20.9	1.07	93
	4-Mar-2021	7.75	988.7	19.7	1.05	128
	2-Dec-2020	7.74	919.0	20.1	1.12	156
	2-Sep-2020	7.29	1,711	22.2	1.09	238
	2-Jun-2020	7.30	1,207	20.3	1.11	200
	25-Feb-2020	7.55	1,121	17.8	0.73	145
	5-Dec-2019	7.09	856.9	21.5	5.21	162
	21-Aug-2019	7.40	1,196	20.5	2.29	180
	23-May-2019	7.01	971.4	19.9	2.38	264
	8-Mar-2019	7.37	1,031	19.4	1.17	138
	29-Nov-2018	6.88	918.1	20.6	1.06	127
	24-Aug-2018	7.40	880.4	21.6	3.70	98
	31-May-2018	7.39	935.7	19.7	2.66	56
	27-Feb-2018	7.48	863.4	20.3	2.04	113
	28-Nov-2017	7.71	992.4	21.8	3.51	105
	25-Aug-2017	7.58	1,146	21.0	2.58	185
	7-Jun-2007	7.15	1,051	20.05	2.27	82.6
	13-Mar-2017	7.41	1,145	15.36	2.18	226.5
5-Dec-2016	7.42	1,225	20.94	1.09	173.9	
8-Sep-2016	7.40	1,640	20.80	1.68	NM	
6-Jun-2016	6.90	1,729	19.60	1.72	270.2	
1-Mar-2016	7.56	1,550	19.74	1.54	216.9	

**TABLE 2. SUMMARY OF MONITORING WELL GROUNDWATER FIELD PARAMETERS
DONA ANA DAIRIES, DONA ANA COUNTY, NEW MEXICO**

Monitoring Well	Date Measured	pH	SpC (uS/cm)	Temp (°C)	DO (mg/L)	ORP (mV)
DAD-18 Vertical Delineation	13-Dec-2023	7.19	4,051	17.8	2.23	113
	12-Sep-2023	7.20	4,012	18.1	1.41	141
	5-Jun-2023	7.27	4,110	18.5	2.46	146
	8-Mar-2023	7.27	4,197	18.4	2.30	93
	8-Dec-2022	7.29	4,171	18.0	2.48	100
	12-Sep-2022	7.20	4,051	18.2	1.11	94
	31-May-2022	7.28	3,973	18.5	2.39	84
	18-Mar-2022	7.23	3,896	17.1	2.99	185
	6-Dec-2021	7.72	3,919	17.6	2.84	63
	2-Sep-2021	7.41	4,016	19.4	2.37	140
	30-Nov-2015	7.46	1,621	19.06	2.78	226.0
	2-Sep-2015	7.35	2,099	20.55	NM	252.1
	7-Jun-2021	7.32	4,121	20.0	1.93	232
	4-Mar-2021	7.86	4,111	17.7	2.21	151
	3-Dec-2020	7.21	4,082	18.0	2.41	181
	2-Sep-2020	7.41	4,258	19.6	1.74	182
	2-Jun-2020	7.44	4,289	20.4	2.96	187
	25-Feb-2020	7.68	4,070	17.3	1.01	189
	5-Dec-2019	6.74	3,955	18.2	3.58	173
	20-Aug-2019	6.95	4,150	18.8	1.53	157
	28-May-2019	6.61	3,984	18.8	2.08	293
	11-Mar-2019	6.74	2,771	18.0	1.66	177
	29-Nov-2018	7.78	4,066	18.5	1.59	152
	28-Aug-2018	6.91	4,090	19.2	2.46	213
	4-Jun-2018	6.44	4,253	19.0	2.49	150
	28-Feb-2018	6.94	4,289	18.2	2.64	170
	29-Nov-2017	7.31	4,233	17.9	3.03	202
	29-Aug-2017	6.91	4,326	19.2	2.21	260
	12-Jun-2017	7.20	3,957	19.58	4.32	72.8
	8-Mar-2017	7.19	4,011	18.81	1.41	232.4
5-Dec-2016	7.14	3,914	18.32	2.52	191.4	
9-Sep-2016	7.17	4,290	20.70	1.62	NM	
6-Jun-2016	6.95	3,722	19.15	4.73	273.2	
1-Mar-2016	7.40	3,852	18.76	4.26	329.2	

**TABLE 2. SUMMARY OF MONITORING WELL GROUNDWATER FIELD PARAMETERS
DONA ANA DAIRIES, DONA ANA COUNTY, NEW MEXICO**

Monitoring Well	Date Measured	pH	SpC (uS/cm)	Temp (°C)	DO (mg/L)	ORP (mV)
DAD-19 Vertical Delineation	12-Dec-2023	7.17	4,719	20.4	1.61	195
	11-Sep-2023	7.22	4,671	25.2	2.52	160
	1-Jun-2023	7.20	4,744	22.3	1.84	156
	7-Mar-2023	7.26	4,752	22.0	2.65	151
	7-Dec-2022	7.28	4,708	20.8	2.80	174
	1-Sep-2022	7.21	4,708	22.5	2.66	116
	27-May-2022	7.24	4,655	23.1	1.55	203
	17-Mar-2022	7.20	4,570	21.7	2.66	188
	2-Dec-2021	7.53	4,603	23.8	2.67	170
	1-Sep-2021	7.68	4,673	24.1	2.59	167
	30-Nov-2015	7.23	3,781	18.11	2.89	239.5
	2-Sep-2015	7.24	4,009	19.26	NM	252.9
	4-Jun-2021	7.51	4,389	22.1	2.94	200
	3-Mar-2021	7.53	4,229	24.3	2.40	129
	4-Dec-2020	7.17	4,463	22.1	2.19	271
	3-Sep-2020	7.62	4,546	22.8	1.33	256
	2-Jun-2020	7.62	4,591	23.6	4.42	187
	25-Feb-2020	7.36	4,395	18.6	0.60	108
	4-Dec-2019	6.98	4,506	20.1	3.98	112
	20-Aug-2019	6.77	4,907	23.0	1.64	129
	28-May-2019	6.23	4,731	23.3	1.33	274
	11-Mar-2019	6.78	2,565	21.1	1.28	179
	30-Nov-2018	6.71	4,376	21.8	1.88	191
	28-Aug-2018	7.00	4,489	22.5	1.94	186
	4-Jun-2018	6.36	4,800	23.0	2.06	112
	28-Feb-2018	6.71	4,742	21.5	2.85	155
	29-Nov-2017	6.90	4,728	21.7	3.08	192
	29-Aug-2017	6.83	4,634	22.4	2.02	225
	12-Jun-2017	7.19	4,383	22.64	4.21	-29.7
	13-Mar-2017	6.92	4,644	21.94	1.82	320.8
6-Dec-2016	7.34	4,573	22.75	1.80	213.7	
9-Sep-2016	7.08	4,610	23.60	1.84	NM	
8-Jun-2016	6.75	4,410	22.74	1.85	247.1	
1-Mar-2016	7.10	4,729	21.91	1.98	290.9	

**TABLE 2. SUMMARY OF MONITORING WELL GROUNDWATER FIELD PARAMETERS
DONA ANA DAIRIES, DONA ANA COUNTY, NEW MEXICO**

Monitoring Well	Date Measured	pH	SpC (uS/cm)	Temp (°C)	DO (mg/L)	ORP (mV)
DAD-20	15-Dec-2023	Well damaged; Could not be sampled.				
	14-Sep-2023	7.19	3,721	23.5	2.00	132
	9-Jun-2023	7.23	4,076	22.7	1.22	131
	10-Mar-2023	7.25	3,620	22.3	1.39	146
	12-Dec-2022	7.31	3,478	21.7	2.71	207
	14-Sep-2022	7.20	3,555	23.1	2.95	115
	2-Jun-2022	7.28	4,104	23.3	1.55	207
	23-Mar-2022	7.29	4,107	21.7	2.78	195
	8-Dec-2021	7.28	3,960	22.0	2.30	169
	7-Sep-2021	7.47	3,863	22.8	2.34	142
	30-Nov-2015	7.13	4,730	21.08	3.07	248.2
	2-Sep-2015	7.09	4,900	24.03	NM	238.0
	28-May-2021	7.58	3,954	24.1	2.90	101
	8-Mar-2021	7.87	3,808	22.7	2.82	107
	7-Dec-2020	7.53	3,895	21.5	2.90	208
	8-Sep-2020	7.40	4,452	24.2	1.79	229
	4-Jun-2020	7.11	4,211	24.6	2.39	295
	19-Feb-2020	7.39	3,626	21.8	1.95	151
	2-Dec-2019	6.78	3,752	22.0	2.02	141
	21-Aug-2019	7.03	3,721	23.3	5.51	113
	28-May-2019	6.60	3,838	22.5	1.24	285
	7-Mar-2019	7.11	2,571	22.1	1.20	143
	30-Nov-2018	7.11	3,569	20.2	1.04	174
	28-Aug-2018	7.08	3,829	23.4	1.28	235
	1-Jun-2018	6.79	3,904	23.2	1.62	145
	28-Feb-2018	7.05	3,888	21.7	1.36	186
	28-Nov-2017	7.33	3,726	22.5	5.04	198
	24-Aug-2017	7.14	3,711	23.3	4.53	63
	7-Jun-2017	6.92	3,446	22.41	2.76	175.9
	10-Mar-2017	7.24	3,557	22.46	2.75	235.1
5-Dec-2016	7.19	3,719	22.19	6.05	176.2	
7-Sep-2016	7.46	3,880	23.40	6.29	NM	
6-Jun-2016	7.02	3,499	22.51	5.70	271.7	
1-Mar-2016	7.42	3,517	21.55	5.29	308.0	

**TABLE 2. SUMMARY OF MONITORING WELL GROUNDWATER FIELD PARAMETERS
DONA ANA DAIRIES, DONA ANA COUNTY, NEW MEXICO**

Monitoring Well	Date Measured	pH	SpC (uS/cm)	Temp (°C)	DO (mg/L)	ORP (mV)
DAD-21	14-Dec-2023	7.22	3,983	21.8	2.88	192
	13-Sep-2023	7.20	4,126	22.8	2.49	141
	6-Jun-2023	7.19	4,305	22.8	2.79	141
	9-Mar-2023	7.30	3,787	22.2	2.48	105
	9-Dec-2022	7.20	3,501	21.1	2.58	175
	13-Sep-2022	7.22	3,851	22.6	2.83	132
	1-Jun-2022	7.18	4,350	23.3	2.35	170
	22-Mar-2022	7.40	4,255	21.1	2.33	180
	7-Dec-2021	7.30	4,303	22.1	2.43	111
	3-Sep-2021	7.18	4,587	23.1	2.85	160
	28-May-2021	7.31	5,019	22.3	2.98	120
	8-Mar-2021	7.15	4,798	21.6	2.90	251
	7-Dec-2020	7.19	4,736	20.8	2.94	218
	3-Sep-2020	7.40	5,055	24.3	1.77	185
	3-Jun-2020	7.38	5,089	23.4	2.36	179
	19-Feb-2020	7.12	4,493	20.3	2.64	162
	6-Dec-2019	6.42	4,622	21.5	2.43	188
	21-Aug-2019	6.92	4,608	23.4	2.80	141
	24-May-2019	6.34	4,382	22.4	1.30	284
	7-Mar-2019	6.84	2,700	21.4	1.20	144
	30-Nov-2018	7.07	3,601	20.4	1.53	148
	27-Aug-2018	6.77	4,447	23.3	1.74	216
	4-Jun-2018	6.45	4,615	21.8	2.42	164
	28-Feb-2018	7.04	4,649	19.9	2.21	191
	28-Nov-2017	7.09	4,340	21.8	2.68	192
	23-Aug-2017	6.87	3,914	23.4	3.37	150
	9-Jun-2017	6.65	3,822	22.21	2.96	133.2
	10-Mar-2017	6.97	4,354	20.41	2.52	191.6
	6-Dec-2016	7.33	3,969	19.88	6.24	489.8
7-Sep-2016	6.94	4,920	22.90	2.70	NM	
6-Jun-2016	6.66	3,931	22.03	3.98	271.5	
29-Feb-2016	7.00	3,327	21.97	3.68	227.5	
DAD-22	14-Dec-2023	7.28	3,694	22.4	2.79	152
	13-Sep-2023	7.25	3,676	23.8	2.79	130
	6-Jun-2023	7.24	3,700	23.9	2.60	133
	9-Mar-2023	7.62	3,690	23.3	2.80	168
	9-Dec-2022	7.35	3,697	22.2	2.84	143
	14-Sep-2022	7.19	3,694	23.0	2.86	144
	2-Jun-2022	7.17	3,692	23.2	2.84	193
	23-Mar-2022	7.14	3,708	22.4	2.83	196
	8-Dec-2021	7.17	3,712	22.0	2.86	165
	3-Sep-2021	7.54	3,673	25.5	2.11	155
	23-Nov-2015	7.17	3,174	21.19	4.52	122.1
	2-Sep-2015	7.17	3,349	23.03	NM	225.0
	28-May-2021	7.51	3,694	24.2	2.80	142
	8-Mar-2021	7.49	3,621	23.6	2.75	153
	7-Dec-2020	7.52	3,608	21.9	2.80	214
	8-Sep-2020	7.30	5,963	23.1	1.58	204
	3-Jun-2020	7.34	3,810	24.6	2.83	184
	19-Feb-2020	7.54	3,581	22.6	2.14	137
	6-Dec-2019	7.11	3,432	22.1	4.25	137
	21-Aug-2019	7.27	3,752	25.2	2.98	179
	24-May-2019	6.54	3,012	24.1	1.87	274
	7-Mar-2019	7.18	2,879	23.4	2.20	137
	30-Nov-2018	7.64	2,839	21.1	1.98	149
	24-Aug-2018	7.43	3,692	24.7	2.84	133
	1-Jun-2018	7.37	3,831	25.9	1.88	137
	27-Feb-2018	7.31	3,856	22.9	1.70	150
	28-Nov-2017	7.91	3,847	23.6	3.84	191
	23-Aug-2017	7.26	3,812	25.5	3.24	141
	7-Jun-2017	7.12	4,114	27.32	4.63	91.5
	7-Mar-2017	7.70	3,915	22.36	2.29	202.1
	5-Dec-2016	7.36	3,808	22.17	4.75	170.5
6-Sep-2016	7.68	4,060	2.39	3.72	NM	
8-Jun-2016	6.98	3,907	24.86	4.36	230.3	
25-Feb-2016	7.12	3,802	22.15	3.71	192.0	

**TABLE 2. SUMMARY OF MONITORING WELL GROUNDWATER FIELD PARAMETERS
DONA ANA DAIRIES, DONA ANA COUNTY, NEW MEXICO**

Monitoring Well	Date Measured	pH	SpC (uS/cm)	Temp (°C)	DO (mg/L)	ORP (mV)
DAD-23	6-Dec-2023	7.29	2,486	22.7	2.27	156
	31-Aug-2023	7.37	3,881	24.5	2.22	103
	26-May-2023	7.22	3,760	23.3	2.53	148
	3-Mar-2023	7.24	3,105	21.0	1.74	151
	5-Dec-2022	7.23	3,425	22.7	2.26	177
	26-Aug-2022	7.28	2,607	23.4	1.83	77
	25-May-2022	7.30	3,473	23.2	1.79	188
	15-Mar-2022	7.52	3,691	22.2	1.98	138
	1-Dec-2021	7.20	3,175	21.9	1.80	172
	26-Aug-2021	7.88	3,510	23.6	1.71	106
	23-Nov-2015	7.28	2,913	22.16	3.95	126.0
	2-Sep-2015	7.65	4,065	25.17	NM	207.8
	3-Jun-2021	7.37	3,377	23.0	1.58	141
	2-Mar-2021	7.90	3,336	22.4	1.67	122
	1-Dec-2020	7.68	2,113	22.2	1.60	144
	28-Aug-2020	7.57	2,081	24.8	1.54	62
	1-Jun-2020	7.34	2,386	22.6	1.75	161
	26-Feb-2020	7.62	2,043	21.4	0.61	119
	6-Dec-2019	7.34	2,911	21.4	3.70	165
	19-Aug-2019	7.45	2,614	24.2	2.91	103
	24-May-2019	7.03	2,511	22.9	2.71	293
	8-Mar-2019	7.42	2,973	22.5	1.23	164
	28-Nov-2018	7.93	3,168	21.9	1.79	146
	27-Aug-2018	7.54	2,388	23.8	1.23	248
	31-May-2018	7.04	3,050	23.4	3.04	118
	26-Feb-2018	7.82	3,046	22.0	2.21	144
	29-Nov-2017	7.66	3,178	22.6	2.88	179
	24-Aug-2017	7.37	3,565	23.4	2.59	209
	7-Jun-2017	7.29	3,380	23.87	4.96	64.9
	7-Mar-2017	7.55	3,433	21.99	2.54	181.5
	5-Dec-2016	7.65	2,354	22.16	2.64	197.4
7-Sep-2016	7.40	3,580	23.10	2.52	NM	
DAD-24 Vertical Delineation	8-Dec-2023	7.25	4,402	22.3	1.33	126
	11-Sep-2023	7.19	4,377	25.3	2.33	142
	1-Jun-2023	7.21	4,327	24.4	2.30	156
	7-Mar-2023	7.25	4,255	22.9	2.87	130
	7-Dec-2022	7.29	4,233	21.7	2.80	195
	1-Sep-2022	7.23	4,180	23.8	1.93	134
	27-May-2022	7.29	4,135	24.5	1.36	167
	17-Mar-2022	7.24	4,044	22.1	2.63	194
	2-Dec-2021	7.25	4,054	21.8	1.27	116
	1-Sep-2021	7.23	4,050	23.1	2.93	142
	2-Jun-2016	7.54	2,308	23.32	1.64	62.0
	29-Feb-2016	7.60	2,402	22.54	1.10	126.8
	4-Jun-2021	7.12	4,060	22.4	1.29	178
	3-Mar-2021	7.40	4,011	22.3	2.54	116
	4-Dec-2020	7.09	3,944	22.2	1.01	217
	2-Sep-2020	7.74	4,135	24.8	2.09	188
	2-Jun-2020	7.63	4,205	24.3	2.89	191
	25-Feb-2020	7.00	3,770	20.3	0.39	114
	4-Dec-2019	6.47	3,881	21.5	4.21	96
	20-Aug-2019	6.58	4,077	23.4	1.89	114
	28-May-2019	6.42	3,978	22.7	1.71	275
	11-Mar-2019	6.80	2,533	21.2	1.44	153
	30-Nov-2018	6.70	3,797	21.4	1.30	175
	31-Aug-2018	6.60	3,978	22.5	1.29	118
	4-Jun-2018	6.32	4,011	24.3	3.56	106
	28-Feb-2018	6.66	4,091	21.6	3.31	179
	29-Nov-2017	6.64	4,114	21.5	3.11	175
	29-Aug-2007	6.61	4,199	22.7	1.60	224
	12-Jun-2017	6.92	4,221	24.28	2.78	226.3
	13-Mar-2017	6.70	4,248	22.44	1.35	220.8
6-Dec-2016	7.00	4,221	23.71	0.30	-261.3	
9-Sep-2016	7.13	2,860	23.20	1.28	NM	

**TABLE 2. SUMMARY OF MONITORING WELL GROUNDWATER FIELD PARAMETERS
DONA ANA DAIRIES, DONA ANA COUNTY, NEW MEXICO**

Monitoring Well	Date Measured	pH	SpC (uS/cm)	Temp (°C)	DO (mg/L)	ORP (mV)
DAD-25	13-Dec-2023	7.30	3,347	21.5	2.63	169
	12-Sep-2023	7.21	3,341	22.7	2.57	141
	5-Jun-2023	7.25	3,328	23.5	2.83	130
	9-Mar-2023	7.23	3,051	22.2	2.21	133
	8-Dec-2022	7.41	3,012	22.6	2.23	110
	12-Sep-2022	7.31	2,889	23.8	2.09	72
	1-Jun-2022	7.25	2,251	22.4	1.72	190
	18-Mar-2022	7.61	1,297	22.4	1.02	163
	7-Dec-2021	7.76	1,467	21.2	1.13	101
	3-Sep-2021	7.45	1,221	24.1	1.00	94
	8-Jun-2016	6.97	2,634	22.98	1.86	244.7
	1-Mar-2016	7.20	2,507	22.26	1.89	237.4
	7-Jun-2021	7.19	3,460	23.9	2.84	204
	4-Mar-2021	7.66	3,289	22.1	2.52	132
	3-Dec-2020	7.57	3,204	20.8	2.54	208
	2-Sep-2020	7.33	3,150	25.0	2.32	208
	2-Jun-2020	7.10	3,119	24.8	2.42	165
	26-Feb-2020	7.55	2,840	21.4	0.87	105
	6-Dec-2019	6.67	2,755	20.9	1.84	231
	22-Aug-2019	7.15	2,712	25.0	3.42	262
	28-May-2019	6.79	2,547	22.3	2.47	296
	11-Mar-2019	7.09	2,207	21.3	2.17	142
	29-Nov-2018	7.34	2,521	21.7	1.93	127
	28-Aug-2018	7.53	2,425	22.9	2.41	189
	4-Jun-2018	6.87	2,393	22.5	3.17	125
	27-Feb-2018	7.09	2,300	22.9	3.28	146
	27-Nov-2017	7.51	2,256	22.3	3.29	157
	25-Aug-2017	7.12	2,706	23.0	3.64	232
	8-Jun-2017	6.73	2,663	23.04	4.82	54.7
	10-Mar-2017	7.12	4,093	22.57	3.34	247.5
2-Dec-2016	6.98	4,949	21.57	3.02	131.3	
8-Sep-2016	7.17	5,560	23.10	3.32	NM	

**TABLE 2. SUMMARY OF MONITORING WELL GROUNDWATER FIELD PARAMETERS
DONA ANA DAIRIES, DONA ANA COUNTY, NEW MEXICO**

Monitoring Well	Date Measured	pH	SpC (uS/cm)	Temp (°C)	DO (mg/L)	ORP (mV)
DAD-26	15-Dec-2023	7.20	4,395	21.9	1.41	201
	14-Sep-2023	7.18	4,382	23.6	1.35	126
	6-Jun-2023	7.19	3,286	23.7	2.53	133
	10-Mar-2023	7.25	3,440	22.6	2.70	140
	12-Dec-2022	7.27	2,982	22.0	2.21	174
	14-Sep-2022	7.24	3,067	23.4	2.34	124
	2-Jun-2022	7.24	3,000	23.3	2.24	205
	23-Mar-2022	7.25	2,906	22.3	2.19	193
	8-Dec-2021	7.11	2,587	22.3	1.95	156
	7-Sep-2021	7.18	2,918	23.7	2.14	115
	6-Jun-2016	6.79	3,918	22.59	3.04	268.3
	1-Mar-2016	7.11	5,434	22.49	2.12	297.6
	28-May-2021	7.75	3,390	24.3	2.54	132
	8-Mar-2021	7.59	3,733	23.0	2.90	128
	7-Dec-2020	7.23	3,040	21.8	2.32	245
	8-Sep-2020	7.39	3,558	23.8	2.56	197
	3-Jun-2020	7.75	3,725	23.8	2.79	174
	19-Feb-2020	7.49	2,189	23.0	2.00	191
	6-Dec-2019	7.13	1,659	23.7	4.13	158
	21-Aug-2019	6.92	3,715	24.3	1.17	210
	28-May-2019	6.37	3,735	22.7	2.60	285
	7-Mar-2019	6.71	2,631	22.5	1.44	155
	30-Nov-2018	7.02	3,233	18.3	1.17	160
	28-Aug-2018	7.30	4,386	23.4	1.16	224
	4-Jun-2018	6.31	4,516	22.9	2.84	161
	28-Feb-2018	6.72	4,910	22.1	3.37	187
	28-Nov-2017	6.97	5,006	22.7	2.93	200
	28-Aug-2017	6.71	5,160	23.0	3.12	205
	9-Jun-2017	6.59	5,039	23.4	3.02	37.3
	10-Mar-2017	6.81	5,283	22.37	2.65	310.3
	6-Dec-2016	7.25	5,006	21.07	3.01	285.3
8-Sep-2016	7.16	4,880	23.60	2.40	NM	
6-Jun-2016	6.70	4,273	23.39	1.77	270.3	
1-Mar-2016	7.30	3,959	21.09	1.36	245.7	
DAD-27	14-Dec-2023	7.24	2,932	21.7	2.26	163
	14-Sep-2023	7.26	3,118	22.0	2.45	123
	6-Jun-2023	7.22	3,065	22.4	2.23	138
	10-Mar-2023	7.18	2,818	21.4	2.15	141
	12-Dec-2022	7.18	3,013	21.3	2.35	182

Notes:

* = Monitoring well contains a pump; as a result, DO and ORP values are not representative of aquifer conditions.

°C = Degrees Celsius

DO = Dissolved oxygen

mg/L = Milligrams per liter

mV = Millivolts

NM = Not measured

NS = Not sampled

ORP = Oxidation-reduction potential

SpC = Specific conductance

Temp = Temperature

uS/cm = Microsiemens per centimeter

Data from current quarter.

Red text indicates suspect result.

**TABLE 3. SUMMARY OF SAMPLE ANALYTICAL METHODS AND SAMPLING REQUIREMENTS
DONA ANA DAIRIES, DONA ANA COUNTY, NEW MEXICO**

Target Analytes	Analytical Method	Sample Container	Preservative	Holding Time
Nitrate as N	EPA 300.0	500 mL HDPE	Cool to <6°C	48 hours
Nitrate + Nitrite as N	EPA 300.0	500 mL HDPE	H ₂ SO ₄ to pH <2, Cool to <6°C	28 days
Total Kjeldhal Nitrogen	SM 4500 NORG C	500 mL HDPE	H ₂ SO ₄ to pH <2, Cool to <6°C	28 days
Chloride	EPA 300.0	500 mL HDPE	Cool to <6°C	28 days
Total Dissolved Solids	SM 2540 C MOD	500 mL HDPE	Cool to <6°C	7 days

Notes:

°C = Degrees Celsius

EPA = U.S. Environmental Protection Agency

H₂SO₄ = Sulfuric acid

HDPE = High-density polyethylene

mL = milliliter

MOD = Modified

N = Nitrogen

SM = Standard method

**TABLE 4. ABATEMENT PLAN MONITORING WELL GROUNDWATER ANALYTICAL RESULTS
DONA ANA DAIRIES, DONA ANA COUNTY, NEW MEXICO**

Monitoring Well	Date Sampled	Nitrate (mg/l)	TKN (mg/l)	Chloride (mg/l)	TDS (mg/l)	Sulfate (mg/l)
Abatement Plan Monitoring Wells						
Northern Portion						
DAD-01	5-Dec-23	11	<0.50	360	1,450	NA
	30-Aug-23	13	<2.0	390	1,310	NA
	25-May-23	13	<2.0	370	1,460	NA
	2-Mar-23	16	<2.0	470	1,690	NA
	1-Dec-22	12	<2.0	420	1,520	NA
	24-Aug-22	10	<2.0	360	1,520	NA
	24-May-22	16	<2.0	370	1,530	NA
	3-Mar-22	20	<5.0	420	1,750	NA
	23-Nov-21	18	<2.0	380	819	NA
	25-Aug-21	20	<5.0	350	1,520	NA
	1-Jun-21	19	<2.0	340	1,510	NA
	1-Mar-21	18	<2.0	410	1,660	NA
	30-Nov-20	16	<2.0	430	1,640	NA
	27-Aug-20	16	<2.0	310	1,390	NA
	29-May-20	15	<5.0	310	1,420	NA
	21-Feb-20	13	<1.0	420	1,740	NA
	3-Dec-19	12	<2.0	360	1,500	NA
	19-Aug-19	12	<2.0	290	1,520	NA
	22-May-19	13	<2.0	300	1,420	NA
	5-Mar-19	11	<2.0	350	1,690	NA
	28-Nov-18	12	<2.0	320	1,430	NA
	24-Aug-18	15	<2.0	280	1,350	NA
	31-May-18	15	<2.0	250	1,310	NA
	26-Feb-18	9.5	<1.0	350	1,520	NA
	20-Nov-17	9.46	<0.300	400	1,500	NA
	24-Aug-17	10.4	<0.0500	396	1,560	NA
	8-Jun-17	17.0	<0.100	354	1,600	NA
	7-Mar-17	7.90	<0.300	438	1,620	NA
	30-Nov-16	5.19	<0.300	482	1,690	NA
	6-Sep-16	5.35	<0.937	502	1,580	NA
	2-Jun-16	3.27	<2.24	457	1,730	NA
	25-Feb-16	2.70	7.28	512	1,770	NA
	23-Nov-15	4.17	<1.18	491	1,680	NA
	1-Sep-15	8.52	2.10	420	1,600	NA
	27-May-15	10.9	<1.18	418	1,640	NA
	4-Mar-15	4.70	<1.80	459	1,910	NA
	3-Dec-14	6.53	<1.80	468	1,780	NA
	29-Aug-14	8.28	<1.80	425	1,830	NA
	3-Jun-14	6.13	<1.80	491	2,020	NA
	10-Mar-14	5.76	<1.66	496	1,780	NA
	11-Dec-13	7.61	3.50	471	1,760	NA
	10-Sep-13	4.43	2.80	472	1,920	NA
	16-May-13	10.4	<1.66	408	1,930	NA
28-Feb-13	10.0	<1.72	469	1,740	NA	
3-Dec-12	10.7	<1.72	348	1,800	NA	
21-Aug-12	9.98	<1.72	373	1,640	NA	
9-May-12	6.88	2.80	401	1,660	NA	
31-Jan-12	9.90	2.52	439	1,520	NA	
27-Oct-11	9.56	3.50	436	1,840	256	
20-Jul-11	12.0	2.38	426	1,650	NA	
20-Apr-11	10.3	<2.17	460	1,710	NA	
24-Jan-11	19.8	3.50	408	1,820	NA	
16-Sep-10	7.56	<10.0	439	1,800	NA	
29-Jun-10	8.55	<1.0	491	2,120	NA	
21-Mar-10	6.3	<5.0	500	1,780	NA	
9-Dec-09	7.5	1.5	550	2,010	NA	
NMED Split	9-Dec-09	7.3	2.8	468	356	264
	29-Aug-09	7.3	<5.0	540	1,970	NA
	12-May-09	5.6	<1.0	540	1,800	NA

**TABLE 4. ABATEMENT PLAN MONITORING WELL GROUNDWATER ANALYTICAL RESULTS
DONA ANA DAIRIES, DONA ANA COUNTY, NEW MEXICO**

Monitoring Well	Date Sampled	Nitrate (mg/l)	TKN (mg/l)	Chloride (mg/l)	TDS (mg/l)	Sulfate (mg/l)
DAD-02	6-Dec-23	6.5	<2.5	670	2,290	NA
	5-Sep-23	6.9	<2.0	610	2,070	NA
	26-May-23	8.4	<2.0	460	1,610	NA
	3-Mar-23	9.2	<1.0	400	1,480	NA
	5-Dec-22	8.7	<1.0	380	1,560	NA
	26-Aug-22	9.6	<1.0	350	1,540	NA
	25-May-22	9.5	<1.0	310	1,280	NA
	16-Mar-22	8.8	<1.0	300	1,230	NA
	30-Nov-21	9.0	<1.0	270	1,140	NA
	26-Aug-21	8.8	<1.0	250	1,090	NA
	3-Jun-21	8.7	<1.0	230	1,070	NA
	2-Mar-21	9.4	<1.0	240	1,110	NA
	1-Dec-20	9.0	<1.0	250	1,090	NA
	28-Aug-20	8.1	<1.0	250	1,110	NA
	29-May-20	8.5	<2.0	230	1,070	NA
	21-Feb-20	8.9	<1.0	250	1,240	NA
	4-Dec-19	8.9	<2.0	260	1,180	NA
	19-Aug-19	8.3	<1.0	270	1,140	NA
	22-May-19	7.8	<1.0	280	1,220	NA
	5-Mar-19	7.6	<1.0	290	1,350	NA
	28-Nov-18	10	<2.0	350	1,410	NA
	24-Aug-18	11	<2.0	390	1,440	NA
	31-May-18	9.4	<1.0	430	1,570	NA
	26-Feb-18	10	<2.0	490	1,640	NA
	20-Nov-17	11.7	<0.300	534	1,500	NA
	24-Aug-17	11.4	<0.0500	479	1,580	NA
	8-Jun-17	11.3	<0.100	473	1,570	NA
	7-Mar-17	11.5	<0.300	522	1,650	NA
	30-Nov-16	10.1	<0.300	506	1,610	NA
	6-Sep-16	9.10	<0.937	500	1,460	NA
	2-Jun-16	9.45	<2.24	467	1,470	NA
	25-Feb-16	10.7	5.60	520	1,480	NA
	23-Nov-15	10.3	<1.18	493	1,600	NA
	31-Aug-15	10.3	3.50	511	1,760	NA
	27-May-15	10.6	<1.18	465	1,540	NA
	4-Mar-15	9.15	<1.80	440	1,560	NA
	3-Dec-14	8.47	<1.80	542	1,710	NA
	29-Aug-14	7.05	<1.80	451	1,690	NA
	3-Jun-14	5.18	<1.80	506	1,640	NA
	10-Mar-14	7.75	<1.66	463	1,620	NA
	11-Dec-13	7.91	2.80	443	1,540	NA
	9-Sep-13	7.14	<1.66	337	1,900	NA
	16-May-13	9.19	<1.66	393	1,750	NA
	1-Mar-13	8.52	<1.72	357	1,520	NA
3-Dec-12	8.51	<1.72	345	1,800	NA	
21-Aug-12	4.39	2.10	301	1,570	NA	
9-May-12	7.71	<1.72	373	1,830	NA	
31-Jan-12	7.66	<2.17	335	1,720	NA	
27-Oct-11	8.30	2.52	380	1,360	475	
20-Jul-11	7.66	<2.17	374	1,750	NA	
21-Apr-11	7.97	<2.17	434	1,760	NA	
24-Jan-11	6.38	2.80	443	2,240	NA	
16-Sep-10	3.44	<10.0	385	1,790	NA	
29-Jun-10	8.11	< 0.5	364	1,870	NA	
21-Mar-10	8.1	<1.0	420	1,970	NA	
9-Dec-09	9.0	<1.0	440	1,920	NA	
NMED Split	9-Dec-09	9	0.39	388	1,970	586
	29-Aug-09	9.9	<2.0	490	1,890	NA
	14-May-09	7.4	<5.0	350	1,700	NA

**TABLE 4. ABATEMENT PLAN MONITORING WELL GROUNDWATER ANALYTICAL RESULTS
DONA ANA DAIRIES, DONA ANA COUNTY, NEW MEXICO**

Monitoring Well	Date Sampled	Nitrate (mg/l)	TKN (mg/l)	Chloride (mg/l)	TDS (mg/l)	Sulfate (mg/l)
DAD-11 Vertical Delineation (formerly 177-03)	6-Dec-23	31	<0.50	1,000	3,490	NA
	31-Aug-23	24	<5.0	860	3,280	NA
	25-May-23	17	<2.0	730	3,100	NA
	3-Mar-23	13	<1.0	770	2,970	NA
	2-Dec-22	11	<2.0	590	2,860	NA
	25-Aug-22	12	<2.0	640	2,820	NA
	25-May-22	12	<2.0	680	2,830	NA
	15-Mar-22	11	<2.0	640	2,850	NA
	30-Nov-21	12	<2.0	640	2,780	NA
	25-Aug-21	12	<2.0	650	2,790	NA
	1-Jun-21	12	2.5	640	2,810	NA
	1-Mar-21	13	<2.0	620	2,730	NA
	1-Dec-20	13	<2.0	630	2,700	NA
	28-Aug-20	11	<2.0	610	2,670	NA
	26-Feb-20	12	<2.0	670	2,690	NA
	12-Dec-19	13	<2.0	610	2,670	NA
	20-Aug-19	13	<2.0	690	2,820	NA
	28-May-19	13	<2.0	690	2,840	NA
	11-Mar-19	13	<2.0	670	2,740	NA
	3-Dec-18	13	<2.0	710	2,840	NA
	29-Aug-18	16	<2.0	730	2,960	NA
	31-May-18	14	<2.0	690	2,930	NA
	26-Feb-18	10	<2.0	590	2,450	NA
	29-Nov-17	3.80	<0.0500	447	1,660	NA
	29-Aug-17	11.5	<0.0500	550	2,350	NA
	6-Jun-17	12.3	0.564	821	3,030	NA
	8-Mar-17	14.0	0.627	983	3,420	NA
	5-Dec-16	7.40	<0.300	691	2,680	NA
	8-Sep-16	15.4	<0.937	1,200	3,960	NA
	8-Jun-16	14.3	<2.24	1,060	4,040	NA
	29-Feb-16	13.5	<1.18	1,060	3,040	NA
	24-Nov-15	17.1	8.40	1,320	4,030	NA
	1-Sep-15	12.4	<1.18	981	3,120	NA
	29-May-15	13.9	<1.18	990	3,070	NA
	5-Mar-15	19.7	<1.80	1,220	3,960	NA
	5-Dec-14	19.9	<1.80	1,230	3,870	NA
	3-Sep-14	11.1	<1.80	717	2,950	NA
	6-Jun-14	1.31	4.90	477	1,860	NA
	17-Mar-14	12.0	<1.66	890	3,230	NA
	16-Dec-13	15.0	2.10	1,170	3,790	NA
	9-Sep-13	13.6	2.80	1,080	3,560	NA
29-May-13	15.7	<1.66	1,110	3,600	NA	
1-Mar-13	14.6	<1.72	1,190	3,600	NA	
3-Dec-12	13.4	<1.72	1,210	3,870	NA	
21-Aug-12	8.71	<1.72	818	3,020	NA	
14-May-12	0.791	<1.72	359	1,550	NA	
1-Feb-12	2.38	<2.17	456	1,700	NA	
27-Oct-11	<0.500	<2.17	434	1,290	215	
2-Aug-11	<0.500	<2.17	427	1,490	NA	
5-May-11	<0.500	<2.17	398	1,360	NA	
25-Jan-11	4.60	<2.05	386	1,500	NA	
21-Sep-10	3.21	<10.0	369	1,520	NA	
29-Jun-10	1.6	<1.0	430	1,610	NA	
28-Apr-10	1.5	<1.0	450	1,600	NA	
20-Jan-10	1.4	<1.0	460	1,600	NA	
21-Oct-09	1.0	<1.0	430	1,600	NA	
7-Jul-09	0.80	<1.0	470	1,500	NA	
6-May-09	0.97	3.5	450	1,600	NA	
22-Jan-09	1.00	<1.0	370	1,600	NA	

**TABLE 4. ABATEMENT PLAN MONITORING WELL GROUNDWATER ANALYTICAL RESULTS
DONA ANA DAIRIES, DONA ANA COUNTY, NEW MEXICO**

Monitoring Well	Date Sampled	Nitrate (mg/l)	TKN (mg/l)	Chloride (mg/l)	TDS (mg/l)	Sulfate (mg/l)
DAD-12 Vertical Delineation	5-Dec-23	10	0.53	810	3,070	NA
	30-Aug-23	11	<2.0	800	3,040	NA
	25-May-23	10	<2.0	720	2,980	NA
	2-Mar-23	11	<2.0	810	3,120	NA
	1-Dec-22	11	<2.0	930	3,210	NA
	25-Aug-22	11	<2.0	800	3,200	NA
	24-May-22	11	<2.0	900	3,230	NA
	3-Mar-22	12	<2.0	950	3,240	NA
	23-Nov-21	12	<2.0	870	3,420	NA
	25-Aug-21	13	<2.0	1,100	3,550	NA
	1-Jun-21	12	<2.0	1,100	3,550	NA
	1-Mar-21	13	<2.0	1,100	3,520	NA
	30-Nov-20	14	<2.0	1,200	3,590	NA
	27-Aug-20	13	2.5	1,100	3,510	NA
	29-May-20	15	1.1	1,100	3,590	NA
	26-Feb-20	15	<2.0	1,200	3,660	NA
	3-Dec-19	20	<5.0	480	1,960	NA
	20-Aug-19	15	<2.0	1,200	3,700	NA
	28-May-19	15	<2.0	1,200	3,690	NA
	11-Mar-19	18	<2.0	1,100	3,630	NA
	3-Dec-18	17	<2.0	1,100	3,650	NA
	28-Aug-18	20	<2.0	1,100	3,710	NA
	1-Jun-18	21	<5.0	1,200	3,740	NA
	27-Feb-18	21	<5.0	1,200	3,820	NA
	29-Nov-17	19.3	<0.0500	1,200	3,430	NA
	28-Aug-17	25.6	<0.0500	1,070	3,580	NA
	12-Jun-17	21.0	<0.100	975	3,330	NA
	8-Mar-17	25.7	<0.0501	1,200	3,690	NA
	5-Dec-16	20.7	<0.300	1,180	3,760	NA
	8-Sep-16	19.2	<0.937	805	2,960	NA
	8-Jun-16	18.2	<2.24	889	2,900	NA
	29-Feb-16	20.7	<1.18	809	2,980	NA
	24-Nov-15	19.8	<1.18	735	2,860	NA
	1-Sep-15	19.8	<1.18	759	2,950	NA
	29-May-15	14.6	<1.18	705	2,860	NA
	6-Mar-15	19.0	<1.80	625	2,860	NA
	4-Dec-14	19.0	<1.80	620	2,760	NA
	3-Sep-14	18.6	<1.80	588	2,700	NA
	9-Jun-14	19.3	<1.80	603	2,750	NA
	17-Mar-14	20.5	<1.66	621	2,890	NA
13-Dec-13	18.5	2.10	638	2,840	NA	
10-Sep-13	18.1	2.80	557	2,950	NA	
29-May-13	18.2	<1.66	686	3,130	NA	
28-Feb-13	22.8	<1.72	688	2,820	NA	
3-Dec-12	16.4	<1.72	689	3,070	NA	
21-Aug-12	17.8	2.10	620	2,990	NA	
14-May-12	23.1	<1.72	561	2,870	NA	
1-Feb-12	20.8	<2.17	614	2,670	NA	
7-Dec-11	18.8	<2.17	597	2,620	616	

**TABLE 4. ABATEMENT PLAN MONITORING WELL GROUNDWATER ANALYTICAL RESULTS
DONA ANA DAIRIES, DONA ANA COUNTY, NEW MEXICO**

Monitoring Well	Date Sampled	Nitrate (mg/l)	TKN (mg/l)	Chloride (mg/l)	TDS (mg/l)	Sulfate (mg/l)
DAD-13	5-Dec-23	26	<0.50	850	2,650	NA
	30-Aug-23	11	<2.0	580	2,000	NA
	25-May-23	11	<2.0	570	2,230	NA
	2-Mar-23	12	<2.0	690	2,330	NA
	2-Dec-22	12	<2.0	630	2,390	NA
	25-Aug-22	6.8	<1.0	660	2,380	NA
	24-May-22	13	<2.0	580	2,250	NA
	3-Mar-22	9.0	<1.0	740	2,500	NA
	23-Nov-21	8.3	<1.0	550	2,240	NA
	25-Aug-21	8.1	<1.0	520	2,180	NA
	1-Jun-21	11	<2.0	500	2,110	NA
	1-Mar-21	15	<2.0	530	2,110	NA
	30-Nov-20	17	<2.0	460	1,920	NA
	28-Aug-20	13	<2.0	600	2,210	NA
	29-May-20	13	<2.0	550	2,130	NA
	26-Feb-20	14	<2.0	580	1,960	NA
	3-Dec-19	16	<2.0	1,100	3,640	NA
	20-Aug-19	11	<2.0	640	2,170	NA
	24-May-19	12	<2.0	590	2,130	NA
	8-Mar-19	10	<1.0	570	2,000	NA
	28-Nov-18	6.6	<1.0	470	1,910	NA
	27-Aug-18	12	<2.0	450	1,800	NA
	31-May-18	16	<2.0	710	2,550	NA
	27-Feb-18	27	<5.0	360	1,740	NA
	27-Nov-17	21.5	<0.0500	418	1,850	NA
	24-Aug-17	16.0	<0.0500	619	2,280	NA
	12-Jun-17	16.0	<0.100	701	2,520	NA
	8-Mar-17	14.0	<0.0501	523	2,020	NA
	5-Dec-16	9.54	<0.300	622	2,240	NA
	8-Sep-16	10.9	<0.937	673	2,300	NA
	2-Jun-16	10.5	<2.24	676	2,310	NA
	25-Feb-16	11.0	<1.18	702	2,200	NA
	24-Nov-15	9.98	<1.18	642	2,280	NA
	1-Sep-15	9.82	<1.18	611	2,300	NA
	29-May-15	11.8	<1.18	666	2,280	NA
	6-Mar-15	6.72	<1.80	553	2,120	NA
	4-Dec-14	9.14	<1.80	581	2,160	NA
	2-Sep-14	6.51	<1.80	386	1,960	NA
	9-Jun-14	5.82	<1.80	507	2,000	NA
	17-Mar-14	6.59	<3.32	528	1,960	NA
13-Dec-13	5.83	<1.66	546	1,940	NA	
9-Sep-13	3.42	2.80	524	1,800	NA	
29-May-13	5.00	<1.66	550	2,020	NA	
28-Feb-13	5.63	<1.72	582	1,970	NA	
3-Dec-12	5.04	<1.72	504	1,810	NA	
21-Aug-12	3.51	<1.72	420	1,900	NA	
10-May-12	8.66	<1.72	514	2,010	NA	
1-Feb-12	7.59	<2.17	537	1,960	NA	
27-Oct-11	7.51	2.52	536	3,700	321	

**TABLE 4. ABATEMENT PLAN MONITORING WELL GROUNDWATER ANALYTICAL RESULTS
DONA ANA DAIRIES, DONA ANA COUNTY, NEW MEXICO**

Monitoring Well	Date Sampled	Nitrate (mg/l)	TKN (mg/l)	Chloride (mg/l)	TDS (mg/l)	Sulfate (mg/l)
DAD-14	5-Dec-23	84	<0.50	1,400	4,050	NA
	31-Aug-23	70	<5.0	1,400	3,930	NA
	26-May-23	60	<5.0	1,200	3,830	NA
	2-Mar-23	45	<5.0	1,100	3,490	NA
	2-Dec-22	36	<5.0	930	2,310	NA
	26-Aug-22	22	<5.0	690	2,850	NA
	24-May-22	18	<2.0	610	2,750	NA
	15-Mar-22	17	<2.0	620	2,670	NA
	23-Nov-21	17	<2.0	590	2,830	NA
	26-Aug-21	16	2.8	630	2,600	NA
	3-Jun-21	15	<2.0	640	2,720	NA
	2-Mar-21	17	<2.0	660	2,640	NA
	1-Dec-20	17	<2.0	660	2,770	NA
	28-Aug-20	18	<2.0	690	2,880	NA
	29-May-20	19	<2.0	720	2,980	NA
	26-Feb-20	20	<2.0	820	3,020	NA
	3-Dec-19	20	<5.0	730	3,060	NA
	20-Aug-19	21	<5.0	820	3,140	NA
	24-May-19	22	<5.0	860	3,260	NA
	8-Mar-19	22	<5.0	830	3,310	NA
	28-Nov-18	21	<5.0	840	3,240	NA
	29-Aug-18	22	<5.0	890	3,180	NA
	31-May-18	21	<5.0	860	3,350	NA
	26-Feb-18	24	<5.0	910	3,210	NA
	27-Nov-17	25.5	0.494	1,010	3,270	NA
	28-Aug-17	28.5	<0.0500	1,010	3,170	NA
	6-Jun-17	32.7	<0.0500	1,060	3,750	NA
	8-Mar-17	39.1	0.0694	1,090	3,780	NA
	2-Dec-16	39.0	<0.300	1,140	3,750	NA
	8-Sep-16	44.5	<0.937	1,170	3,700	NA
	2-Jun-16	40.9	<2.24	1,280	3,700	NA
	29-Feb-16	40.2	<1.18	1,280	3,540	NA
	24-Nov-15	33.9	<1.18	1,220	3,550	NA
	1-Sep-15	32.1	<1.18	1,110	3,260	NA
	29-May-15	32.7	<1.18	1,030	3,320	NA
	5-Mar-15	30.2	<1.80	949	3,280	NA
	4-Dec-14	30.3	<1.80	933	3,200	NA
	2-Sep-14	26.7	2.10	878	3,240	NA
	6-Jun-14	29.6	<1.80	943	3,340	NA
	17-Mar-14	41.3	<1.66	1,040	3,620	NA
13-Dec-13	31.9	<1.66	929	3,160	NA	
9-Sep-13	29.2	3.50	1,010	3,590	NA	
29-May-13	34.6	<1.66	1,030	3,520	NA	
1-Mar-13	42.0	16.8	1,130	3,730	NA	
3-Dec-12	40.3	<1.72	1,150	4,010	NA	
21-Aug-12	33.2	<1.72	919	3,340	NA	
14-May-12	28.8	<1.72	881	3,280	NA	
1-Feb-12	20.3	<2.17	861	2,880	NA	
27-Oct-11	17.2	2.80	835	1,780	447	

**TABLE 4. ABATEMENT PLAN MONITORING WELL GROUNDWATER ANALYTICAL RESULTS
DONA ANA DAIRIES, DONA ANA COUNTY, NEW MEXICO**

Monitoring Well	Date Sampled	Nitrate (mg/l)	TKN (mg/l)	Chloride (mg/l)	TDS (mg/l)	Sulfate (mg/l)
DAD-23	6-Dec-23	17	<0.50	270	1,490	NA
	31-Aug-23	18	<2.0	570	2,360	NA
	26-May-23	18	<2.0	370	1,730	NA
	3-Mar-23	20	1.40	550	2,070	NA
	5-Dec-22	18	<2.0	420	2,030	NA
	26-Aug-22	19	<2.0	320	1,620	NA
	25-May-22	19	<2.0	400	1,700	NA
	15-Mar-22	15	<2.0	620	2,550	NA
	1-Dec-21	16	<2.0	640	2,670	NA
	26-Aug-21	15	<2.0	300	1,420	NA
	3-Jun-21	15	<2.0	540	2,320	NA
	2-Mar-21	15	<2.0	460	2,310	NA
	1-Dec-20	20	<2.0	480	1,890	NA
	28-Aug-20	19	<2.0	280	1,440	NA
	1-Jun-20	21	150	520	1,960	NA
	26-Feb-20	22	<5.0	350	1,570	NA
	6-Dec-19	18	<2.0	540	2,410	NA
	19-Aug-19	17	<2.0	540	2,220	NA
	24-May-19	19	<2.0	390	1,960	NA
	8-Mar-19	17	<2.0	540	2,260	NA
	28-Nov-18	18	<2.0	500	2,090	NA
	27-Aug-18	21	<2.0	580	2,350	NA
	31-May-18	19	<2.0	670	2,500	NA
	26-Feb-18	16	<2.0	490	1,890	NA
	29-Nov-17	18.2	<0.0500	763	2,050	NA
	24-Aug-17	19.5	<0.0500	676	2,500	NA
	7-Jun-17	14.9	<0.100	580	2,300	NA
	7-Mar-17	12.0	<0.300	577	2,230	NA
5-Dec-16	5.57	<0.300	566	1,940	NA	
7-Sep-16	1.86	<0.937	462	1,720	NA	
2-Jun-16	1.10	<2.24	636	2,260	NA	
29-Feb-16	<0.305	<1.18	421	1,680	NA	
21-Dec-15	6.11	<1.18	450	1,860	NA	
NMWQCC Standard		10	NA	250	1,000	600
Existing Conditions - August 2020		NA	NA	1,800	1,598	NA
Existing Conditions - Pre-August 2020*		NA	NA	1,015	3,178	NA

**TABLE 4. ABATEMENT PLAN MONITORING WELL GROUNDWATER ANALYTICAL RESULTS
DONA ANA DAIRIES, DONA ANA COUNTY, NEW MEXICO**

Monitoring Well	Date Sampled	Nitrate (mg/l)	TKN (mg/l)	Chloride (mg/l)	TDS (mg/l)	Sulfate (mg/l)	
Central Portion							
DAD-03	7-Dec-23	<1.0	1.3	310	1,580	NA	
	5-Sep-23	<1.0	2.2	290	2,070	NA	
	26-May-23	<1.0	<1.0	310	1,770	NA	
	6-Mar-23	<1.0	<1.0	360	1,780	NA	
	5-Dec-22	<1.0	<1.0	290	1,610	NA	
	26-Aug-22	<1.0	<1.0	350	1,700	NA	
	26-May-22	<1.0	<2.0	330	2,330	NA	
	16-Mar-22	<1.0	<1.0	330	2,070	NA	
	1-Dec-21	<1.0	<1.0	340	2,070	NA	
	26-Aug-21	<1.0	2.8	410	1,980	NA	
	3-Jun-21	<1.0	<1.0	310	1,660	NA	
	2-Mar-21	<1.0	<2.0	290	1,560	NA	
	1-Dec-20	<1.0	<1.0	270	1,530	NA	
	31-Aug-20	<1.0	<1.0	300	1,620	NA	
	1-Jun-20	<1.0	4.5	300	1,530	NA	
	21-Feb-20	<1.0	<5.0	300	2,090	NA	
	4-Dec-19	<1.0	<2.0	320	1,880	NA	
	19-Aug-19	<1.0	2.5	330	2,140	NA	
	22-May-19	<1.0	3.6	390	2,050	NA	
	5-Mar-19	<1.0	3.1	330	2,180	NA	
	28-Nov-18	<1.0	2.5	320	2,110	NA	
	24-Aug-18	<1.0	<2.0	350	2,520	NA	
	31-May-18	<1.0	<5.0	370	1,930	NA	
	26-Feb-18	<1.0	<2.0	360	2,220	NA	
	20-Nov-17	0.2220	0.498	446	2,060	NA	
	24-Aug-17	0.0823	<0.0500	440	2,240	NA	
	8-Jun-17	0.150	2.67	454	2,110	NA	
	7-Mar-17	0.251	3.09	589	2,570	NA	
	30-Nov-16	0.874	4.29	647	2,820	NA	
	6-Sep-16	<0.305	<0.937	289	2,520	NA	
	2-Jun-16	<0.305	<2.24	540	2,410	NA	
	25-Feb-16	<0.305	3.92	558	2,340	NA	
	23-Nov-15	<0.194	<1.18	603	2,440	NA	
	1-Sep-15	<0.194	1.40	702	2,720	NA	
	27-May-15	<0.0470	<1.18	738	2,620	NA	
	4-Mar-15	<0.0470	<1.80	609	2,630	NA	
	3-Dec-14	<0.126	<1.80	569	2,560	NA	
	29-Aug-14	<0.126	<1.80	686	2,890	NA	
	9-Jun-14	<0.187	<1.80	838	3,410	NA	
	10-Mar-14	0.906	<1.66	917	3,480	NA	
	11-Dec-13	<0.213	<1.66	932	3,180	NA	
	10-Sep-13	Not Sampled - insufficient water to sample					
	16-May-13	1.07	<1.66	1,400	4,420	NA	
	1-Mar-13	0.721	<1.72	1,220	3,720	NA	
	3-Dec-12	1.1	<1.72	1,150	4,760	NA	
	21-Aug-12	<0.0290	2.80	1,090	3,920	NA	
9-May-12	<0.114	2.66	1,200	4,160	NA		
31-Jan-12	<0.500	4.34	1,340	4,350	NA		
26-Oct-11	<0.500	3.22	1,790	5,420	1,100		
20-Jul-11	<1.00	3.22	1,630	4,720	NA		
21-Apr-11	<0.500	<2.17	1,870	5,600	NA		
24-Jan-11	<0.00955	4.20	1,590	4,660	NA		
16-Sep-10	0.217	<10.0	1,370	4,320	NA		
29-Jun-10	<0.5	6.18	1,570	5,150	NA		
21-Mar-10	<10	<1.0	2,200	5,620	NA		
9-Dec-09	<10	<5.0	2,100	5,590	NA		
NMED Split	9-Dec-09	<0.1	0.88	1,570	5,300	1,160	
	29-Aug-09	<0.10	<5.0	1,400	4,420	NA	
	12-May-09	<10	<5.0	1,200	5,000	NA	

**TABLE 4. ABATEMENT PLAN MONITORING WELL GROUNDWATER ANALYTICAL RESULTS
DONA ANA DAIRIES, DONA ANA COUNTY, NEW MEXICO**

Monitoring Well	Date Sampled	Nitrate (mg/l)	TKN (mg/l)	Chloride (mg/l)	TDS (mg/l)	Sulfate (mg/l)
DAD-04	7-Dec-23	<1.0	0.75	410	2,130	NA
	6-Sep-23	<1.0	1.4	390	2,240	NA
	30-May-23	Dry				
	6-Mar-23	Dry				
	6-Dec-22	<1.0	<1.0	400	2,020	NA
	31-Aug-22	<1.0	1.3	80	826	NA
	26-May-22	1.1	1.3	150	1,340	NA
	16-Mar-22	2.3	1.3	500	2,510	NA
	1-Dec-21	2.1	1.1	470	2,190	NA
	31-Aug-21	7.5	1.4	450	2,390	NA
	3-Jun-21	5.0	1.4	380	2,300	NA
	2-Mar-21	1.4	1.1	340	2,270	NA
	2-Dec-20	4.4	1.3	310	2,120	NA
	31-Aug-20	<1.0	1.3	330	2,000	NA
	1-Jun-20	<1.0	8.8	320	1,940	NA
	21-Feb-20	<1.0	<1.0	320	1,950	NA
	4-Dec-19	<1.0	<1.0	330	2,020	NA
	19-Aug-19	<1.0	<1.0	320	1,770	NA
	23-May-19	<1.0	<2.0	330	1,720	NA
	5-Mar-19	<1.0	<1.0	340	1,820	NA
	28-Nov-18	<1.0	<1.0	350	1,770	NA
	24-Aug-18	<1.0	<1.0	300	1,700	NA
	31-May-18	<1.0	<1.0	280	1,710	NA
	26-Feb-18	<1.0	<1.0	230	1,520	NA
	20-Nov-17	0.314	0.734	32.3	900	NA
	24-Aug-17	0.109	<0.0500	380	1,920	NA
	8-Jun-17	0.133	0.956	349	1,800	NA
	7-Mar-17	0.257	0.632	317	1,760	NA
	2-Dec-16	1.46	1.41	343	2,040	NA
	6-Sep-16	<0.305	<0.937	497	1,830	NA
	2-Jun-16	0.633	<2.24	547	2,060	NA
	25-Feb-16	<0.305	<1.18	434	1,730	NA
	23-Nov-15	0.0853	6.16	443	1,690	NA
	1-Sep-15	<0.194	2.10	561	2,320	NA
	27-May-15	0.176	<1.18	475	1,820	NA
	4-Mar-15	0.819	<1.80	195	1,280	NA
	3-Dec-14	1.65	<1.80	185	1,260	NA
	29-Aug-14	<0.126	<1.80	483	2,060	NA
	3-Jun-14	0.988	3.50	740	2,810	NA
	10-Mar-14	1.01	<1.66	694	2,600	NA
	11-Dec-13	1.69	<1.66	604	2,400	NA
	5-Sep-13	0.827	9.10	544	2,710	NA
	16-May-13	<0.0420	<1.66	613	2,320	NA
	1-Mar-13	2.12	<1.72	510	2,090	NA
	5-Dec-12	2.740	<1.72	545	2,430	NA
	21-Aug-12	<0.0290	<1.72	496	2,620	NA
	9-May-12	0.305	<1.72	502	1,970	NA
	31-Jan-12	2.05	<2.17	493	2,320	NA
26-Oct-11	<0.500	2.80	590	2,950	380	
20-Jul-11	<0.500	<2.17	670	2,540	NA	
20-Apr-11	<0.500	<2.17	584	2,570	NA	
24-Jan-11	<0.00955	2.66	608	2,400	NA	
16-Sep-10	<0.100	<10.0	683	2,560	NA	
29-Jun-10	<0.5	1.4	570	2,330	NA	
21-Mar-10	<2.0	<2.0	620	2,460	NA	
9-Dec-09	<2.0	1.7	810	2,720	NA	
NMED Split	9-Dec-09	<0.1	1.2	659	2,630	373
	29-Aug-09	<2.0	<5.0	690	2,690	NA
	13-May-09	<2.0	<5.0	690	2,700	NA

**TABLE 4. ABATEMENT PLAN MONITORING WELL GROUNDWATER ANALYTICAL RESULTS
DONA ANA DAIRIES, DONA ANA COUNTY, NEW MEXICO**

Monitoring Well	Date Sampled	Nitrate (mg/l)	TKN (mg/l)	Chloride (mg/l)	TDS (mg/l)	Sulfate (mg/l)
DAD-05	12-Dec-23	<1.0	3.8	180	1,180	NA
	11-Sep-23	<1.0	3.8	97	872	NA
	1-Jun-23	<1.0	5.6	120	785	NA
	8-Mar-23	<1.0	4.8	110	830	NA
	8-Dec-22	<1.0	3.4	100	900	NA
	12-Sep-22	<1.0	2.8	82	785	NA
	31-May-22	<1.0	15	300	1,610	NA
	17-Mar-22	<1.0	18	310	1,840	NA
	6-Dec-21	<1.0	22	400	1,950	NA
	2-Sep-21	14	14	410	2,370	NA
	7-Jun-21	<1.0	<1.0	370	1,890	NA
	4-Mar-21	<1.0	<1.0	310	1,630	NA
	2-Dec-20	<1.0	<1.0	290	1,660	NA
	31-Aug-20	1.6	<1.0	220	1,370	NA
	1-Jun-20	<1.0	18	290	1,550	NA
	21-Feb-20	<1.0	<1.0	390	2,030	NA
	5-Dec-19	<1.0	<1.0	260	1,550	NA
	22-Aug-19	<1.0	1.3	400	1,930	NA
	23-May-19	1.9	1.3	460	2,190	NA
	5-Mar-19	2.0	1.3	370	2,260	NA
	29-Nov-18	2.2	<2.0	570	2,570	NA
	24-Aug-18	<1.0	1.5	650	2,820	NA
	31-May-18	<1.0	1.1	720	2,750	NA
	26-Feb-18	<1.0	1.30	660	2,720	NA
	27-Nov-17	2.31	1.51	721	2,720	NA
	25-Aug-17	8.77	<0.0500	459	1,970	NA
	8-Jun-17	1.56	1.13	722	2,850	NA
	7-Mar-17	8.37	1.04	434	2,150	NA
	2-Dec-16	2.70	2.02	653	2,840	NA
	6-Sep-16	5.00	<0.937	614	2,480	NA
	2-Jun-16	5.26	<2.24	611	2,710	NA
	25-Feb-16	9.43	<1.18	654	2,660	NA
	23-Nov-15	<0.194	2.80	493	2,100	NA
	1-Sep-15	2.15	1.40	388	2,100	NA
	27-May-15	4.48	<1.18	436	2,180	NA
	4-Mar-15	10.5	<1.80	564	2,400	NA
	3-Dec-14	2.55	<1.80	273	1,300	NA
	29-Aug-14	1.87	<1.80	230	1,200	NA
	3-Jun-14	2.20	<1.80	497	2,000	NA
	10-Mar-14	4.81	<1.66	312	1,510	NA
	12-Dec-13	0.898	2.80	72.9	695	NA
	5-Sep-13	2.16	4.90	120	870	NA
	29-May-13	2.44	<1.66	582	2,580	NA
	5-Mar-13	<0.246	<1.72	519	2,100	NA
	5-Dec-12	3.350	<1.72	690	2,930	NA
	22-Aug-12	<0.0290	<1.72	544	2,260	NA
	9-May-12	0.908	2.10	566	2,380	NA
1-Feb-12	<0.500	<2.17	558	2,020	NA	
26-Oct-11	<0.500	2.66	647	900	377	
20-Jul-11	<0.500	5.04	599	2,460	NA	
20-Apr-11	<0.500	<2.17	430	1,810	NA	
20-Jan-11	0.128	2.10	477	1,870	NA	
16-Sep-10	<2.50	<10.0	536	2,220	NA	
29-Jun-10	< 0.5	1.1	627	2,550	NA	
21-Mar-10	<2.0	<1.0	630	2,340	NA	
9-Dec-09	<2.0	1.3	710	2,420	NA	
NMED Split	9-Dec-09	<0.1	0.95	563	2,290	362
	29-Aug-09	<2.0	<2.0	630	2,310	NA
	13-May-09	<2.0	<5.0	640	2,700	NA
Duplicate	13-May-09	<10	1.6	618	2,260	NA

**TABLE 4. ABATEMENT PLAN MONITORING WELL GROUNDWATER ANALYTICAL RESULTS
DONA ANA DAIRIES, DONA ANA COUNTY, NEW MEXICO**

Monitoring Well	Date Sampled	Nitrate (mg/l)	TKN (mg/l)	Chloride (mg/l)	TDS (mg/l)	Sulfate (mg/l)
DAD-06	4-Nov-22	Plugged and Abandoned				
	13-Sep-22	Dry				
	27-May-22	Dry				
	9-Feb-22	Dry				
	1-Dec-21	Dry				
	31-Aug-21	Dry				
	4-Jun-21	Dry				
	3-Mar-21	Dry				
	1-Dec-20	Dry				
	31-Aug-20	Dry				
	1-Jun-20	Dry				
	9-Mar-20	Dry				
	4-Dec-19	Dry				
	12-Aug-19	Dry				
	28-May-19	Dry				
	14-Mar-19	Dry				
	4-Dec-18	Dry				
	31-Aug-18	Dry				
	4-Jun-18	Dry				
	28-Feb-18	Dry				
	28-Nov-17	Dry				
	28-Aug-17	Dry				
	12-Jun-17	Dry				
	13-Mar-17	Dry				
	6-Dec-16	Dry				
	8-Sep-16	Dry				
	6-Jun-16	Dry				
	25-Feb-16	Dry				
	23-Nov-15	Dry				
	1-Sep-15	Dry				
	28-May-15	Dry				
	4-Mar-15	Dry				
	4-Dec-14	Dry				
	12-Aug-14	Dry				
	13-May-14	Dry				
	10-Mar-14	Dry				
	11-Dec-13	Dry				
	5-Sep-13	Dry				
	30-May-13	6.07	<1.66	508	1,690	NA
	4-Mar-13	7.66	<1.72	496	1,510	NA
	5-Dec-12	8.25	<1.72	439	1,610	NA
	21-Aug-12	9.11	2.10	347	1,530	NA
	9-May-12	11.0	<1.72	375	1,570	NA
	31-Jan-12	13.6	<2.17	382	1,510	NA
	27-Oct-11	9.20	<2.17	322	1,060	228
	20-Jul-11	18.0	3.64	358	1,370	NA
	21-Apr-11	18.0	<2.17	349	1,330	NA
24-Jan-11	12.2	2.10	360	1,270	NA	
16-Sep-10	9.20	<10.0	359	1,370	NA	
29-Jun-10	11.6	<2.0	365	1,460	NA	
21-Mar-10	10	<2.0	390	1,390	NA	
9-Dec-09	10	<1.0	380	1,380	NA	
NMED Split	9-Dec-09	8.6	0.36	354	1,440	262
	29-Aug-09	8.2	<5.0	390	1,260	NA
	14-May-09	11	<5.0	350	1,300	NA
Duplicate	14-May-09	8.17	0.4	338	1,250	NA
DAD-06R	8-Dec-23	9.6	<0.50	98	347	NA
	6-Sep-23	6.3	<1.0	110	726	NA
	30-May-23	6.4	5.6	84	580	NA
	7-Mar-23	4.5	<1.0	88	610	NA
	6-Dec-22	3.9	1.7	100	696	NA

**TABLE 4. ABATEMENT PLAN MONITORING WELL GROUNDWATER ANALYTICAL RESULTS
DONA ANA DAIRIES, DONA ANA COUNTY, NEW MEXICO**

Monitoring Well	Date Sampled	Nitrate (mg/l)	TKN (mg/l)	Chloride (mg/l)	TDS (mg/l)	Sulfate (mg/l)
DAD-07	13-Dec-23	43	<0.50	720	3,220	NA
	6-Sep-23	34	<5.0	560	2,800	NA
	5-Jun-23	25	<5.0	530	2,400	NA
	9-Mar-23	19	<2.0	450	2,120	NA
	7-Dec-22	20	<5.0	410	2,060	NA
	13-Sep-22	17	<2.0	370	1,890	NA
	1-Jun-22	17	<2.0	410	2,000	NA
	22-Mar-22	18	<2.0	480	2,160	NA
	7-Dec-21	18	<2.0	500	2,200	NA
	1-Sep-21	18	<1.0	600	2,310	NA
	4-Jun-21	18	<2.0	630	2,340	NA
	3-Mar-21	17	<2.0	630	2,420	NA
	4-Dec-20	17	<2.0	650	2,550	NA
	3-Sep-20	16	<2.0	740	2,520	NA
	3-Jun-20	15	<2.0	570	2,310	NA
	25-Feb-20	14	<2.0	570	2,190	NA
	5-Dec-19	13	<2.0	520	2,140	NA
	21-Aug-19	13	<2.0	560	2,190	NA
	24-May-19	12	<2.0	540	2,140	NA
	8-Mar-19	12	<2.0	530	2,050	NA
	29-Nov-18	11	<2.0	500	1,980	NA
	27-Aug-18	12	<2.0	500	2,060	NA
	1-Jun-18	12	<2.0	540	2,260	NA
	27-Feb-18	12	<2.0	740	2,530	NA
	28-Nov-17	12.3	<0.0500	701	2,160	NA
	28-Aug-17	11.2	<0.0500	576	2,040	NA
	6-Jun-17	7.69	<0.0500	529	2,030	NA
	10-Mar-17	6.07	<0.0501	480	1,800	NA
	5-Dec-16	4.97	<0.300	467	1,820	NA
	7-Sep-16	5.50	<0.937	583	1,940	NA
	8-Jun-16	4.87	<2.24	526	1,820	NA
	1-Mar-16	5.27	<1.18	609	2,020	NA
	30-Nov-15	6.82	<1.18	638	2,020	NA
	1-Sep-15	7.45	<1.18	649	2,060	NA
	28-May-15	5.83	<1.18	619	1,960	NA
	5-Mar-15	5.34	<1.80	554	2,060	NA
	3-Dec-14	6.85	<1.80	607	2,180	NA
	2-Sep-14	7.48	<1.80	589	2,150	NA
	12-Jun-14	5.44	<1.80	540	2,020	NA
	11-Mar-14	4.84	2.10	512	1,980	NA
	11-Dec-13	7.94	<1.66	700	2,270	NA
	5-Sep-13	7.01	3.50	650	2,380	NA
24-May-13	8.42	<1.66	720	2,570	NA	
5-Mar-13	8.15	<1.72	724	2,740	NA	
5-Dec-12	8.03	<1.72	718	2,610	NA	
22-Aug-12	6.88	<1.72	671	2,540	NA	
9-May-12	3.81	<1.72	588	2,150	NA	
31-Jan-12	5.40	<2.17	610	1,640	NA	
26-Oct-11	5.22	2.24	591	750	426	
20-Jul-11	4.67	2.80	554	1,880	NA	
20-Apr-11	4.14	<2.17	525	1,780	NA	
19-Jan-11	0.410	<2.05	518	1,740	NA	
16-Sep-10	<2.50	<10.0	637	1,990	NA	
29-Jun-10	5.17	<0.5	569	2,060	NA	
21-Mar-10	5.1	<1.0	640	1,970	NA	
9-Dec-09	5.4	<1.0	620	1,900	NA	
NMED Split	9-Dec-09	5.2	<0.1	536	1,870	403
	29-Aug-09	4.4	<5.0	610	1,780	NA
	14-May-09	4.6	<1.0	530	1,800	NA

**TABLE 4. ABATEMENT PLAN MONITORING WELL GROUNDWATER ANALYTICAL RESULTS
DONA ANA DAIRIES, DONA ANA COUNTY, NEW MEXICO**

Monitoring Well	Date Sampled	Nitrate (mg/l)	TKN (mg/l)	Chloride (mg/l)	TDS (mg/l)	Sulfate (mg/l)
DAD-08	13-Dec-23	42	<2.5	1,400	4,100	NA
	12-Sep-23	42	<5.0	1,500	4,150	NA
	5-Jun-23	44	<5.0	1,600	4,240	NA
	8-Mar-23	45	<5.0	1,600	4,260	NA
	8-Dec-22	45	14	1,500	3,960	NA
	12-Sep-22	46	11	1,600	4,780	NA
	31-May-22	47	<5.0	1,800	4,700	NA
	18-Mar-22	44	<5.0	1,600	4,520	NA
	6-Dec-21	46	<5.0	1,700	4,490	NA
	2-Sep-21	46	<5.0	1,900	4,580	NA
	7-Jun-21	50	<5.0	2,000	5,040	NA
	3-Mar-21	45	<5.0	1,800	4,880	NA
	3-Dec-20	42	<5.0	1,800	4,660	NA
	2-Sep-20	42	<5.0	1,800	4,770	NA
	2-Jun-20	43	<5.0	1,800	5,070	NA
	21-Feb-20	40	<5.0	1,800	4,930	NA
	4-Dec-19	43	<1.0	1,800	4,920	NA
	19-Aug-19	39	<5.0	1,800	5,270	NA
	23-May-19	47	<5.0	1,800	5,540	NA
	5-Mar-19	42	<5.0	1,900	5,460	NA
	29-Nov-18	40	<5.0	1,800	4,760	NA
	24-Aug-18	47	<5.0	2,000	5,680	NA
	31-May-18	43	<5.0	1,900	5,400	NA
	26-Feb-18	51	<5.0	1,700	4,710	NA
	27-Nov-17	32.9	0.717	1,580	4,290	NA
	25-Aug-17	32.8	<0.0500	1,450	6,480	NA
	8-Jun-17	37.9	<0.100	1,670	5,140	NA
	7-Mar-17	44.8	<0.300	1,860	5,420	NA
	2-Dec-16	45.9	<0.300	1,990	5,800	NA
	6-Sep-16	44.4	<0.937	1,950	5,940	NA
	2-Jun-16	52.9	<2.24	1,960	5,840	NA
	25-Feb-16	51.2	5.60	1,990	5,740	NA
	23-Nov-15	66.1	<1.18	2,070	5,980	NA
	1-Sep-15	65.3	<1.18	2,050	6,160	NA
	28-May-15	63.0	<1.18	2,050	5,840	NA
	5-Mar-15	48.6	<1.80	1,670	5,740	NA
	3-Dec-14	48.1	<1.80	1,700	5,930	NA
	2-Sep-14	39.5	<1.80	1,700	5,220	NA
	4-Jun-14	55.8	2.10	2,210	5,840	NA
	11-Mar-14	71.7	<1.66	2,450	6,400	NA
	12-Dec-13	70.7	2.80	2,500	6,780	NA
	5-Sep-13	74.9	2.80	2,440	7,440	NA
	24-May-13	71.5	<1.66	2,140	6,740	NA
	4-Mar-13	90.0	<1.72	2,280	7,060	NA
	5-Dec-12	40.2	<1.72	2,270	5,980	NA
	22-Aug-12	32.2	<1.72	2,430	7,220	NA
	9-May-12	2.39	<1.72	1,150	3,260	NA
31-Jan-12	2.69	<2.17	1,250	2,990	NA	
26-Oct-11	2.80	<2.17	1,260	2,500	471	
20-Jul-11	3.36	3.78	1,320	3,060	NA	
20-Apr-11	4.33	<2.17	1,300	3,280	NA	
19-Jan-11	<0.239	2.10	1,240	2,600	NA	
17-Sep-10	<2.50	<10.0	1,370	3,230	NA	
29-Jun-10	2.53	<1.0	1,290	5,950	NA	
21-Mar-10	<4.0	<1.0	1,300	3,270	NA	
9-Dec-09	<4.0	<1.0	1,400	3,290	NA	
NMED Split	9-Dec-09	3.1	0.26	1,400	3,070	509
	29-Aug-09	<4.0	<2.0	1,500	3,180	NA
	14-May-09	3.0	<5.0	1,300	3,600	NA

**TABLE 4. ABATEMENT PLAN MONITORING WELL GROUNDWATER ANALYTICAL RESULTS
DONA ANA DAIRIES, DONA ANA COUNTY, NEW MEXICO**

Monitoring Well	Date Sampled	Nitrate (mg/l)	TKN (mg/l)	Chloride (mg/l)	TDS (mg/l)	Sulfate (mg/l)
DAD-15	8-Dec-23	18	<0.50	720	5,060	NA
	5-Sep-23	21	<5.0	710	2,660	NA
	30-May-23	15	<2.0	640	2,320	NA
	6-Mar-23	17	<2.0	780	2,470	NA
	5-Dec-22	17	<2.0	650	2,500	NA
	31-Aug-22	22	<5.0	680	2,550	NA
	26-May-22	20	<5.0	770	2,510	NA
	23-Mar-22	22	<5.0	640	2,590	NA
	2-Dec-21	20	<5.0	700	2,470	NA
	31-Aug-21	17	<2.0	640	2,230	NA
	4-Jun-21	12	<2.0	760	2,280	NA
	4-Mar-21	18	<2.0	650	2,310	NA
	4-Dec-20	17	<2.0	590	2,230	NA
	3-Sep-20	14	<2.0	600	2,210	NA
	1-Jun-20	11	<2.0	600	2,060	NA
	26-Feb-20	11	<2.0	610	2,010	NA
	5-Dec-19	9.8	1.4	520	2,010	NA
	21-Aug-19	13	<1.0	610	2,180	NA
	24-May-19	9.9	<2.0	580	2,160	NA
	8-Mar-19	7.5	<1.0	540	1,970	NA
	30-Nov-18	6.2	<1.0	530	1,840	NA
	27-Aug-18	8.9	<1.0	530	2,080	NA
	1-Jun-18	7.1	<1.0	520	1,960	NA
	27-Feb-18	7.4	<1.0	550	1,970	NA
	20-Nov-17	6.98	<0.300	578	1,710	NA
	28-Aug-17	4.60	<0.0500	502	1,670	NA
	9-Jun-17	6.07	<0.100	532	1,870	NA
	13-Mar-17	5.74	<0.0501	526	1,860	NA
	5-Dec-16	5.12	<0.300	496	1,660	NA
	7-Sep-16	4.21	<0.937	506	1,780	NA
	8-Jun-16	4.41	<2.24	466	1,680	NA
	29-Feb-16	4.30	3.36	536	1,720	NA
24-Nov-15	5.06	<1.18	538	1,720	NA	
1-Sep-15	4.20	<1.18	501	1,760	NA	
29-May-15	5.43	<1.18	536	1,940	NA	
6-Mar-15	5.08	<1.80	491	1,780	NA	
4-Dec-14	5.79	<1.80	508	1,730	NA	
2-Sep-14	5.97	<1.80	489	1,620	NA	
6-Jun-14	6.09	<1.80	510	1,750	NA	
2-Jan-14	4.72	2.10	497	1,780	NA	
10-Sep-13	7.56	3.50	356	1,740	NA	
29-May-13	5.29	<1.66	504	1,970	NA	
4-Mar-13	5.10	<1.72	515	1,800	NA	
4-Dec-12	4.710	<1.72	484	1,810	256	
20-Aug-12	2.370	35.00	351	1,330	256	

**TABLE 4. ABATEMENT PLAN MONITORING WELL GROUNDWATER ANALYTICAL RESULTS
DONA ANA DAIRIES, DONA ANA COUNTY, NEW MEXICO**

Monitoring Well	Date Sampled	Nitrate (mg/l)	TKN (mg/l)	Chloride (mg/l)	TDS (mg/l)	Sulfate (mg/l)
DAD-16	7-Dec-23	1.1	0.73	280	1,640	NA
	6-Sep-23	<1.0	<1.0	250	1,670	NA
	30-May-23	<1.0	<1.0	330	1,760	NA
	6-Mar-23	<1.0	<1.0	410	1,910	NA
	6-Dec-22	<1.0	<1.0	330	1,880	NA
	31-Aug-22	<1.0	<1.0	430	2,120	NA
	26-May-22	<1.0	<1.0	530	2,180	NA
	16-Mar-22	<1.0	<1.0	490	2,100	NA
	1-Dec-21	<1.0	<1.0	540	2,160	NA
	31-Aug-21	<1.0	<1.0	530	2,170	NA
	4-Jun-21	<1.0	<1.0	560	2,250	NA
	3-Mar-21	<1.0	<1.0	430	2,030	NA
	2-Dec-20	<1.0	<1.0	500	2,170	NA
	31-Aug-20	<1.0	<1.0	520	2,200	NA
	1-Jun-20	<1.0	3.1	520	2,080	NA
	25-Feb-20	<1.0	<1.0	400	1,950	NA
	5-Dec-19	<1.0	<1.0	470	2,130	NA
	20-Aug-19	<1.0	<2.0	480	2,100	NA
	23-May-19	<1.0	<2.0	420	2,010	NA
	8-Mar-19	<1.0	<1.0	450	1,990	NA
	29-Nov-18	<1.0	<1.0	520	2,200	NA
	27-Aug-18	<1.0	<1.0	550	2,410	NA
	1-Jun-18	<1.0	<1.0	620	2,440	NA
	27-Feb-18	0.51	<1.0	390	1,780	NA
	28-Nov-17	0.246	0.963	583	2,120	NA
	28-Aug-17	1.18	0.304	723	2,450	NA
	6-Jun-17	0.656	1.11	666	2,710	NA
	8-Mar-17	0.993	0.804	649	2,690	NA
	2-Dec-16	1.76	3.14	342	1,900	NA
	7-Sep-16	1.56	<0.937	821	3,000	NA
	6-Jun-16	1.02	<2.24	423	2,070	NA
	29-Feb-16	0.327	6.72	629	2,440	NA
	30-Nov-15	1.25	<1.18	611	2,520	NA
	2-Sep-15	2.72	1.40	424	1,970	NA
	29-May-15	3.30	1.40	431	2,060	NA
	5-Mar-15	1.04	<1.80	683	2,650	NA
	4-Dec-14	2.79	<1.80	679	2,220	NA
	2-Sep-14	2.44	<1.80	579	2,300	NA
	3-Jun-14	1.49	2.10	569	2,260	NA
	10-Mar-14	1.65	<1.66	573	2,100	NA
12-Dec-13	1.28	2.10	561	2,210	NA	
9-Sep-13	0.832	4.20	538	2,260	NA	
29-May-13	1.68	<1.66	501	2,200	NA	
5-Mar-13	2.55	<1.72	674	2,670	NA	
5-Dec-12	2.420	<1.72	529	2,280	NA	
22-Aug-12	<0.0290	<1.72	472	2,000	NA	
14-May-12	0.147	<1.72	378	2,080	NA	
1-Feb-12	<0.500	<2.17	438	1,960	NA	
27-Oct-11	<0.500	3.36	410	1,520	408	

**TABLE 4. ABATEMENT PLAN MONITORING WELL GROUNDWATER ANALYTICAL RESULTS
DONA ANA DAIRIES, DONA ANA COUNTY, NEW MEXICO**

Monitoring Well	Date Sampled	Nitrate (mg/l)	TKN (mg/l)	Chloride (mg/l)	TDS (mg/l)	Sulfate (mg/l)
DAD-17	12-Dec-23	<1.0	<0.50	100		NA
	11-Sep-23	<1.0	<1.0	66	613	NA
	1-Jun-23	<1.0	<1.0	190	968	NA
	8-Mar-23	<1.0	<1.0	170	938	NA
	8-Dec-22	<1.0	<1.0	170	878	NA
	1-Sep-22	<1.0	<1.0	140	853	NA
	31-May-22	<1.0	<1.0	190	936	NA
	17-Mar-22	2.7	<1.0	170	985	NA
	6-Dec-21	1.2	<1.0	190	985	NA
	2-Sep-21	2.6	<1.0	130	742	NA
	7-Jun-21	4.0	<1.0	180	972	NA
	4-Mar-21	1.3	<1.0	96	634	NA
	2-Dec-20	<1.0	<1.0	92	604	NA
	2-Sep-20	1.8	<1.0	73	586	NA
	2-Jun-20	1.7	<1.0	86	698	NA
	25-Feb-20	<1.0	<1.0	71	554	NA
	5-Dec-19	1.5	<1.0	65	582	NA
	21-Aug-19	4.9	<1.0	120	785	NA
	23-May-19	1.3	<2.0	74	650	NA
	8-Mar-19	2.4	<1.0	89	638	NA
	29-Nov-18	<1.0	<1.0	70	624	NA
	24-Aug-18	2.0	<1.0	56	580	NA
	31-May-18	1.2	<1.0	60	620	NA
	27-Feb-18	0.62	<1.0	54	572	NA
	28-Nov-17	3.17	0.169	65.4	690	NA
	25-Aug-17	10.3	<0.0500	454	1,740	NA
	7-Jun-17	0.939	0.234	84.2	970	NA
	13-Mar-17	0.509	0.352	103	885	NA
	5-Dec-16	1.46	0.370	126	755	NA
	8-Sep-16	1.89	<0.937	169	1,100	NA
	6-Jun-16	0.626	<2.24	240	1,440	NA
	1-Mar-16	<0.0610	<1.18	183	1,260	NA
	30-Nov-15	<0.0387	<1.18	373	1,550	NA
	2-Sep-15	<0.0387	<1.18	270	1,460	NA
	28-May-15	0.486	<1.18	199	1,560	NA
	5-Mar-15	0.797	<1.80	348	1,660	NA
	5-Dec-14	6.87	<1.80	451	1,820	NA
	3-Sep-14	2.48	<1.80	442	1,920	NA
3-Jun-14	1.03	<1.80	525	2,600	NA	
11-Mar-14	3.27	<3.32	440	1,820	NA	
12-Dec-13	2.45	2.80	412	1,640	NA	
9-Sep-13	0.370	2.10	451	2,340	NA	
24-May-13	0.827	<1.66	317	1,400	NA	
5-Mar-13	2.06	<1.72	351	1,550	NA	
5-Dec-12	2.28	<1.72	230	1,260	NA	
22-Aug-12	<0.0290	<1.72	189	930	NA	
10-May-12	<0.114	<1.72	353	1,580	NA	
1-Feb-12	<0.500	3.36	113	714	NA	
26-Oct-11	<0.500	3.50	175	724	186	

**TABLE 4. ABATEMENT PLAN MONITORING WELL GROUNDWATER ANALYTICAL RESULTS
DONA ANA DAIRIES, DONA ANA COUNTY, NEW MEXICO**

Monitoring Well	Date Sampled	Nitrate (mg/l)	TKN (mg/l)	Chloride (mg/l)	TDS (mg/l)	Sulfate (mg/l)
DAD-18 Vertical Delineation	13-Dec-23	10	0.84	640	2,650	NA
	12-Sep-23	7.7	<1.0	630	2,600	NA
	5-Jun-23	7.4	<1.0	680	2,660	NA
	8-Mar-23	6.9	<1.0	690	2,700	NA
	8-Dec-22	6.8	1.1	720	2,670	NA
	12-Sep-22	7.6	16	600	2,590	NA
	31-May-22	7.7	<1.0	690	2,580	NA
	18-Mar-22	6.3	1.1	590	2,530	NA
	6-Dec-21	7.0	<1.0	640	2,510	NA
	2-Sep-21	7.4	<1.0	640	2,580	NA
	7-Jun-21	7.4	<1.0	670	2,700	NA
	4-Mar-21	7.9	<1.0	690	2,660	NA
	3-Dec-20	8.5	<1.0	720	2,730	NA
	2-Sep-20	8.0	<1.0	690	2,740	NA
	2-Jun-20	8.1	<1.0	670	2,760	NA
	25-Feb-20	9.3	<1.0	660	2,690	NA
	5-Dec-19	8.7	<1.0	570	2,620	NA
	20-Aug-19	10	<2.0	650	2,640	NA
	28-May-19	9.5	<2.0	650	2,620	NA
	11-Mar-19	9.4	<2.0	620	2,600	NA
	29-Nov-18	10	<2.0	680	2,650	NA
	28-Aug-18	12	<2.0	630	2,720	NA
	4-Jun-18	12	<2.0	720	2,740	NA
	28-Feb-18	15	<2.0	560	2,750	NA
	29-Nov-17	10.6	0.840	684	2,520	NA
	29-Aug-17	13.6	0.475	620	2,570	NA
	12-Jun-17	10.4	0.652	710	2,760	NA
	8-Mar-17	9.07	0.242	684	2,750	NA
	5-Dec-16	7.88	0.713	684	2,730	NA
	9-Sep-16	6.85	<0.937	688	2,650	NA
	6-Jun-16	8.04	<2.24	671	2,830	NA
	1-Mar-16	8.55	<1.18	918	2,860	NA
	30-Nov-15	8.19	1.68	923	2,760	NA
	2-Sep-15	8.47	3.50	741	2,960	NA
	28-May-15	9.86	1.40	825	2,940	NA
	5-Mar-15	10.0	<1.80	736	2,930	NA
	5-Dec-14	19.3	<1.80	623	2,780	NA
	3-Sep-14	12.1	<1.80	713	2,960	NA
	3-Jun-14	13.2	<1.80	749	2,760	NA
	11-Mar-14	12.8	<1.66	739	2,880	NA
12-Dec-13	11.8	2.10	719	2,840	NA	
9-Sep-13	10.9	2.80	697	3,040	NA	
29-May-13	11.9	<1.66	734	3,020	NA	
5-Mar-13	11.2	<1.72	712	2,700	NA	
5-Dec-12	10.10	<1.72	643	2,690	NA	
22-Aug-12	9.03	4.62	642	2,790	NA	
10-May-12	9.11	<1.72	558	2,700	NA	
1-Feb-12	9.62	<2.17	629	2,470	NA	
7-Dec-11	9.21	<2.17	639	2,670	495	

**TABLE 4. ABATEMENT PLAN MONITORING WELL GROUNDWATER ANALYTICAL RESULTS
DONA ANA DAIRIES, DONA ANA COUNTY, NEW MEXICO**

Monitoring Well	Date Sampled	Nitrate (mg/l)	TKN (mg/l)	Chloride (mg/l)	TDS (mg/l)	Sulfate (mg/l)
DAD-19 Vertical Delineation	12-Dec-23	30	<2.5	1,000	3,070	NA
	11-Sep-23	31	<5.0	950	2,970	NA
	1-Jun-23	33	<5.0	980	3,060	NA
	7-Mar-23	31	<5.0	970	3,060	NA
	7-Dec-22	30	<5.0	960	3,050	NA
	1-Sep-22	32	<5.0	970	3,040	NA
	27-May-22	34	<5.0	1,000	2,960	NA
	17-Mar-22	27	<5.0	980	2,960	NA
	2-Dec-21	36	<5.0	970	3,050	NA
	1-Sep-21	36	<5.0	1,000	3,060	NA
	4-Jun-21	35	<5.0	1,000	2,960	NA
	3-Mar-21	29	<5.0	940	2,810	NA
	4-Dec-20	33	<2.0	920	2,970	NA
	3-Sep-20	30	<5.0	970	2,920	NA
	2-Jun-20	28	<5.0	930	2,890	NA
	25-Feb-20	33	<5.0	940	3,020	NA
	4-Dec-19	35	<1.0	1,000	3,110	NA
	20-Aug-19	46	<5.0	1,000	3,170	NA
	28-May-19	41	<5.0	1,000	3,090	NA
	11-Mar-19	34	<5.0	970	2,920	NA
	30-Nov-18	35	<5.0	990	2,960	NA
	28-Aug-18	24	<5.0	960	2,950	NA
	4-Jun-18	39	<5.0	980	3,070	NA
	28-Feb-18	33	<5.0	890	3,040	NA
	29-Nov-17	25.3	<0.0500	1,040	2,750	NA
	29-Aug-17	30.7	<0.0500	864	2,770	NA
	12-Jun-17	20.7	<0.100	928	2,790	NA
	13-Mar-17	30.7	<0.0501	970	2,870	NA
	6-Dec-16	22.5	<0.300	944	3,420	NA
	9-Sep-16	25.2	<0.937	418	2,910	NA
	8-Jun-16	24.5	<2.24	1,830	2,920	NA
	1-Mar-16	36.3	<1.18	1,060	3,200	NA
	30-Nov-15	41.2	<1.18	1,050	3,260	NA
	2-Sep-15	36.9	<1.18	1,000	3,260	NA
	28-May-15	43.6	<1.18	994	3,240	NA
	6-Mar-15	46.2	<1.80	966	3,160	NA
5-Dec-14	10.7	<1.80	782	2,670	NA	
3-Sep-14	41.0	<1.80	899	3,240	NA	
4-Jun-14	54.3	<1.80	914	3,220	NA	
18-Mar-14	50.3	<1.66	861	3,130	NA	
12-Dec-13	48.9	2.10	930	3,240	NA	
9-Sep-13	54.6	<1.66	1,260	3,270	NA	
30-May-13	71.3	<1.66	951	3,560	NA	
4-Mar-13	69.1	<1.72	986	3,430	NA	
5-Dec-12	54.2	<1.72	851	3,230	NA	
21-Aug-12	59.2	<1.72	843	3,470	NA	
10-May-12	54.8	<1.72	835	3,460	NA	
1-Feb-12	59.8	<2.17	913	2,950	NA	
7-Dec-11	47.4	<2.17	789	3,070	544	

**TABLE 4. ABATEMENT PLAN MONITORING WELL GROUNDWATER ANALYTICAL RESULTS
DONA ANA DAIRIES, DONA ANA COUNTY, NEW MEXICO**

Monitoring Well	Date Sampled	Nitrate (mg/l)	TKN (mg/l)	Chloride (mg/l)	TDS (mg/l)	Sulfate (mg/l)
DAD-24 Vertical Delineation	8-Dec-23	6.2	<0.50	1,100	2,850	NA
	11-Sep-23	6.0	<1.0	980	2,890	NA
	1-Jun-23	6.0	<1.0	990	2,790	NA
	7-Mar-23	5.9	<1.0	970	2,790	NA
	7-Dec-22	5.7	<1.0	940	2,780	NA
	1-Sep-22	5.4	<1.0	1,000	2,710	NA
	27-May-22	5.9	<1.0	1,000	2,610	NA
	17-Mar-22	5.5	<1.0	890	2,620	NA
	2-Dec-21	5.4	<1.0	980	2,610	NA
	1-Sep-21	6.5	<1.0	960	2,690	NA
	4-Jun-21	5.6	<1.0	1,000	2,560	NA
	3-Mar-21	5.5	<1.0	970	2,540	NA
	4-Dec-20	5.4	<1.0	920	2,600	NA
	2-Sep-20	5.6	<1.0	940	2,630	NA
	2-Jun-20	5.5	<1.0	910	2,650	NA
	25-Feb-20	5.5	<1.0	920	2,510	NA
	4-Dec-19	6.2	<1.0	950	2,550	NA
	20-Aug-19	5.8	<1.0	950	2,630	NA
	28-May-19	6.1	<1.0	980	2,590	NA
	11-Mar-19	6.0	<1.0	940	2,490	NA
	30-Nov-18	6.5	<1.0	940	2,560	NA
	31-Aug-18	6.1	<1.0	930	2,600	NA
	4-Jun-18	6.5	<1.0	960	2,570	NA
	28-Feb-18	5.8	<1.0	810	2,480	NA
	29-Nov-17	6.25	<0.0500	994	2,220	NA
	29-Aug-17	4.10	<0.0500	910	2,420	NA
	12-Jun-17	6.94	<0.100	969	2,630	NA
	13-Mar-17	6.84	<0.0501	947	2,530	NA
28-Dec-16	NA	NA	NA	2,600	NA	
6-Dec-16	6.19	<0.300	938	2,630 R	NA	
9-Sep-16	1.84	<0.937	425	1,620	NA	
8-Jun-16	2.55	<2.24	482	1,620	NA	
1-Mar-16	2.22	<1.18	511	1,670	NA	
DAD-25	13-Dec-23	8.4	<2.5	840	2,180	NA
	12-Sep-23	7.6	<1.0	800	2,380	NA
	5-Jun-23	7.9	<1.0	780	2,160	NA
	9-Mar-23	7.7	<1.0	740	1,740	NA
	8-Dec-22	5.8	<1.0	590	1,940	NA
	12-Sep-22	4.8	<1.0	550	1,820	NA
	1-Jun-22	4.4	<1.0	420	1,780	NA
	18-Mar-22	3.4	<2.0	120	840	NA
	7-Dec-21	2.8	2.2	170	1,220	NA
	3-Sep-21	9.5	<2.0	140	880	NA
	7-Jun-21	9.0	<2.0	940	2,440	NA
	4-Mar-21	8.2	<2.0	880	2,030	NA
	3-Dec-20	7.7	<2.0	850	2,080	NA
	2-Sep-20	7.4	<2.0	760	2,180	NA
	2-Jun-20	7.5	<1.0	700	2,500	NA
	26-Feb-20	7.6	<2.0	760	2,100	NA
	6-Dec-19	7.0	<2.0	640	1,800	NA
	22-Aug-19	5.6	<2.0	600	1,830	NA
	28-May-19	5.5	<5.0	600	1,790	NA
	11-Mar-19	4.8	<1.0	560	1,570	NA
	29-Nov-18	5.0	<1.0	550	1,580	NA
	28-Aug-18	5.0	<2.0	510	1,800	NA
	4-Jun-18	5.6	<2.0	550	1,540	NA
	27-Feb-18	6.3	<1.0	490	1,480	NA
	27-Nov-17	6.78	0.411	456	1,310	NA
	25-Aug-17	20.1	0.768	414	1,660	NA
	8-Jun-17	10.1	<0.100	678	1,940	NA
	10-Mar-17	22.5	<0.0501	954	2,920	NA
	2-Dec-16	31.9	<0.300	1,350	3,750	NA
8-Sep-16	32.6	<0.937	1,420	4,010	NA	
6-Jun-16	24.8	<2.24	1,390	3,400	NA	
1-Mar-16	52.5	<1.18	1,380	4,020	NA	
22-Dec-15	57.9	<1.18	1,580	4,640	NA	
NMWQCC Standard		10	NA	250	1,000	600
Existing Conditions - August 2020		NA	NA	367	1,758	NA
Existing Conditions - Pre-August 2020*		NA	NA	1,781	5,328	NA

**TABLE 4. ABATEMENT PLAN MONITORING WELL GROUNDWATER ANALYTICAL RESULTS
DONA ANA DAIRIES, DONA ANA COUNTY, NEW MEXICO**

Monitoring Well	Date Sampled	Nitrate (mg/l)	TKN (mg/l)	Chloride (mg/l)	TDS (mg/l)	Sulfate (mg/l)
Southern Portion						
DAD-09 Perched Aquifer	14-Dec-23	33	<0.50	430	1,860	NA
	13-Sep-23	30	<5.0	410	1,640	NA
	6-Jun-23	33	<5.0	520	1,890	NA
	9-Mar-23	35	<5.0	520	1,880	NA
	9-Dec-22	36	<5.0	570	1,920	NA
	13-Sep-22	32	<5.0	480	1,960	NA
	1-Jun-22	33	<5.0	510	1,960	NA
	22-Mar-22	32	<5.0	510	1,860	NA
	7-Dec-21	35	<5.0	380	1,540	NA
	3-Sep-21	42	<5.0	93	785	NA
	28-May-21	24	<5.0	450	1,800	NA
	8-Mar-21	29	<5.0	510	1,900	NA
	7-Dec-20	24	<5.0	490	1,840	NA
	3-Sep-20	22	<5.0	450	1,720	NA
	3-Jun-20	46	<5.0	550	2,350	NA
	19-Feb-20	72	<5.0	610	2,230	NA
	6-Dec-19	40	<5.0	250	1,340	NA
	21-Aug-19	120	<2.0	890	3,380	NA
	24-May-19	120	<5.0	900	3,410	NA
	7-Mar-19	100	<5.0	950	3,290	NA
	30-Nov-18	74	<5.0	910	3,080	NA
	27-Aug-18	76	<5.0	780	2,910	NA
	4-Jun-18	66	<5.0	870	2,690	NA
	28-Feb-18	60	<5.0	680	2,560	NA
	28-Nov-17	49.0	<0.0500	816	2,290	NA
	23-Aug-17	43.9	<0.0500	665	2,050	NA
	9-Jun-17	66.8	<0.100	773	3,300	NA
	10-Mar-17	55.4	<0.0501	667	2,530	NA
	6-Dec-16	50.2	<0.300	676	2,470	NA
	7-Sep-16	36.0	<0.937	619	2,280	NA
	6-Jun-16	34.9	<2.24	583	2,240	NA
	29-Feb-16	16.2	<1.18	574	2,050	NA
	23-Nov-15	4.95	<1.18	563	1,940	NA
	2-Sep-15	7.22	<1.18	536	1,920	NA
	27-May-15	5.25	<1.18	508	1,920	NA
	4-Mar-15	4.01	<1.80	474	1,800	NA
	5-Dec-14	4.27	<1.80	495	1,800	NA
	28-Aug-14	5.25	<1.80	466	1,720	NA
	4-Jun-14	3.14	<1.80	440	1,580	NA
	18-Mar-14	3.44	<1.66	418	1,480	NA
	16-Dec-13	17.4	<1.66	294	1,200	NA
	30-Aug-13	12.3	2.10	454	1,800	NA
	30-May-13	9.69	<1.66	435	1,740	NA
6-Mar-13	17.1	<1.72	494	1,840	NA	
4-Dec-12	33.1	<1.72	588	2,200	NA	
20-Aug-12	48.4	<1.72	656	2,540	NA	
10-May-12	50.9	<1.72	561	2,270	NA	
31-Jan-12	59.8	<2.17	622	2,220	NA	
26-Oct-11	77.7	<2.17	728	1,600	433	
20-Jul-11	70.2	<2.17	727	2,500	NA	
20-Apr-11	47.5	<2.17	483	1,910	NA	
19-Jan-11	42.8	2.38	745	2,600	NA	
17-Sep-10	22.6	<10.0	204	47	NA	
29-Jun-10	59.2	<5.0	667	2,240	NA	
21-Mar-10	29	<5.0	290	1,190	NA	
9-Dec-09	26	<5.0	300	1,190	NA	
NMED Split	9-Dec-09	22	1.6	228	1,170	152
	29-Aug-09	46	<5.0	640	2,320	NA
	13-May-09	44	<5.0	740	2,400	NA

**TABLE 4. ABATEMENT PLAN MONITORING WELL GROUNDWATER ANALYTICAL RESULTS
DONA ANA DAIRIES, DONA ANA COUNTY, NEW MEXICO**

Monitoring Well	Date Sampled	Nitrate (mg/l)	TKN (mg/l)	Chloride (mg/l)	TDS (mg/l)	Sulfate (mg/l)
DAD-10 Regional Aquifer	14-Dec-23	1.1	<2.5	380	1,450	NA
	13-Sep-23	1.0	<1.0	360	1,340	NA
	9-Jun-23	1.1	<1.0	400	1,330	NA
	10-Mar-23	1.3	<2.0	440	1,530	NA
	9-Dec-22	1.2	<1.0	420	1,280	NA
	14-Sep-22	<1.0	<1.0	360	1,250	NA
	2-Jun-22	1.2	<1.0	390	1,400	200
	23-Mar-22	1.4	<1.0	390	1,660	NA
	8-Dec-21	1.4	<2.0	460	1,750	NA
	24-Aug-21	1.0	<1.0	400	1,490	NA
	28-May-21	<1.0	<2.0	390	1,330	NA
	8-Mar-21	1.5	<2.0	410	1,550	NA
	24-Nov-20	1.5	1.4	420	1,330	NA
	3-Sep-20	1.3	<2.0	400	1,380	NA
	4-Jun-20	1.3	<2.0	390	1,460	NA
	19-Feb-20	1.5	<1.0	380	1,480	NA
	2-Dec-19	1.7	<2.0	390	1,380	NA
	22-Aug-19	1.7	<2.0	390	1,330	NA
	24-May-19	1.7	<5.0	390	1,670	NA
	11-Mar-19	2.5	<1.0	380	1,280	NA
	30-Nov-18	4.9	<1.0	420	1,510	NA
	27-Aug-18	4.1	<1.0	380	1,410	NA
	4-Jun-18	5.5	<2.0	410	1,430	NA
	28-Feb-18	9.1	<1.0	360	1,440	NA
	28-Nov-17	14.5	<0.0500	457	1,540	NA
	25-Aug-17	1.14	<0.0500	100	790	NA
	9-Jun-17	15.5	<0.100	446	1,790	NA
	8-Mar-17	8.40	<0.0501	435	1,610	NA
	6-Dec-16	15.6	<0.300	443	1,710	NA
	7-Sep-16	14.8	<0.937	451	1,620	NA
	6-Jun-16	16.9	<2.24	426	1,720	NA
	29-Feb-16	10.5	<1.18	457	1,610	NA
	24-Nov-15	0.723	<1.18	146	1,560	NA
	3-Sep-15	6.53	<1.18	455	1,680	NA
	27-May-15	13.1	<1.18	490	1,550	NA
	4-Mar-15	13.9	<1.80	453	1,720	NA
	5-Dec-14	12.8	<1.80	461	1,720	NA
	3-Oct-14	12.5	<1.80	419	1,720	NA
	28-Aug-14	17.0	<1.80	445	1,740	NA
	9-Jun-14	6.86	<1.80	454	1,560	NA
	18-Mar-14	7.79	<1.66	475	1,620	NA
	16-Dec-13	8.34	4.90	475	1,600	NA
	5-Sep-13	6.01	3.50	451	1,480	NA
	23-May-13	5.42	<1.66	453	1,450	NA
	6-Mar-13	4.83	<1.72	468	1,620	NA
	4-Dec-12	4.33	<1.72	434	1,510	NA
	20-Aug-12	2.86	<1.72	389	2,520	NA
10-May-12	1.52	<1.72	361	1,400	NA	
31-Jan-12	<0.500	<2.17	433	800	NA	
26-Oct-11	3.33	2.80	384	1,150	206	
20-Jul-11	2.29	<2.17	383	1,290	NA	
20-Apr-11	1.30	<2.17	411	1,340	NA	
19-Jan-11	12.7	2.10	429	1,140	NA	
17-Sep-10	2.73	<10.0	404	1,320	NA	
29-Jun-10	1.28	<1.0	390	1,360	NA	
21-Mar-10	<2.0	<1.0	420	1,380	NA	
9-Dec-09	1.4	<1.0	460	1,360	NA	
NMED Split	9-Dec-09	1.5	<0.1	378	1,340	196
	29-Aug-09	1.2	<1.0	420	1,340	NA
	14-May-09	<2.0	<1.0	410	1,300	NA

**TABLE 4. ABATEMENT PLAN MONITORING WELL GROUNDWATER ANALYTICAL RESULTS
DONA ANA DAIRIES, DONA ANA COUNTY, NEW MEXICO**

Monitoring Well	Date Sampled	Nitrate (mg/l)	TKN (mg/l)	Chloride (mg/l)	TDS (mg/l)	Sulfate (mg/l)
DAD-20 Perched Aquifer	15-Dec-23	Well damaged; Could not be sampled.				
	14-Sep-23	33	<5.0	690	2,340	NA
	9-Jun-23	29	<5.0	940	2,520	NA
	10-Mar-23	30	<5.0	840	2,220	NA
	12-Dec-22	25	<5.0	630	2,050	NA
	14-Sep-22	21	<5.0	790	2,620	NA
	2-Jun-22	23	<5.0	1,000	2,730	450
	23-Mar-22	21	<5.0	730	2,300	NA
	8-Dec-21	28	<5.0	910	2,540	NA
	7-Sep-21	26	<5.0	860	2,480	NA
	28-May-21	24	<5.0	870	2,340	NA
	8-Mar-21	28	<5.0	860	2,490	NA
	7-Dec-20	26	<5.0	880	2,740	NA
	8-Sep-20	30	<5.0	960	2,730	NA
	4-Jun-20	31	<5.0	890	2,840	NA
	19-Feb-20	34	<5.0	820	2,470	NA
	2-Dec-19	36	<5.0	790	2,430	NA
	21-Aug-19	40	<2.0	780	2,500	NA
	28-May-19	37	<5.0	850	2,600	NA
	7-Mar-19	35	<5.0	900	2,530	NA
	30-Nov-18	36	<5.0	870	2,530	NA
	28-Aug-18	36	<5.0	850	2,510	NA
	1-Jun-18	35	<5.0	850	2,530	NA
	28-Feb-18	32	<5.0	710	2,390	NA
	28-Nov-17	36.6	<0.0500	891	2,350	NA
	24-Aug-17	31.4	<0.0500	760	2,310	NA
	7-Jun-17	30.6	<0.100	727	2,300	NA
	10-Mar-17	29.0	<0.0501	797	2,410	NA
	5-Dec-16	22.7	<0.300	798	2,360	NA
	7-Sep-16	22.7	<0.937	864	2,460	NA
	6-Jun-16	23.8	<2.24	784	2,420	NA
	1-Mar-16	22.5	<1.18	867	2,390	NA
	24-Nov-15	21.8	<1.18	810	2,350	NA
2-Sep-15	21.0	<1.18	817	2,400	NA	
27-May-15	20.2	<1.18	905	2,460	NA	
4-Mar-15	20.4	<1.80	784	2,340	NA	
4-Dec-14	20.8	<1.80	806	2,240	NA	
28-Aug-14	19.3	<1.80	603	2,400	NA	
9-Jun-14	20.4	<1.80	773	2,470	NA	
18-Mar-14	20.6	<1.66	665	2,120	NA	
16-Dec-13	20.2	2.10	732	2,140	NA	
5-Sep-13	19.2	5.60	808	2,870	NA	
23-May-13	25.2	<1.66	707	2,320	NA	
6-Mar-13	29.5	<1.72	710	2,280	NA	
4-Dec-12	17.0	<1.72	704	2,350	NA	
10-May-12	Obstruction in Well					
31-Jan-12	21.2	<2.17	568	1,000	NA	
7-Dec-11	16.1	<2.17	611	2,020	383	

**TABLE 4. ABATEMENT PLAN MONITORING WELL GROUNDWATER ANALYTICAL RESULTS
DONA ANA DAIRIES, DONA ANA COUNTY, NEW MEXICO**

Monitoring Well	Date Sampled	Nitrate (mg/l)	TKN (mg/l)	Chloride (mg/l)	TDS (mg/l)	Sulfate (mg/l)
DAD-21 Perched Aquifer	14-Dec-23	28	<0.50	660	2,430	NA
	13-Sep-23	35	<5.0	710	2,590	NA
	6-Jun-23	46	<5.0	780	2,620	NA
	9-Mar-23	24	<5.0	640	2,380	NA
	9-Dec-22	24	<5.0	640	2,300	NA
	13-Sep-22	26	<5.0	690	2,590	NA
	1-Jun-22	41	<5.0	870	2,980	NA
	22-Mar-22	41	<5.0	900	2,840	NA
	7-Dec-21	54	<5.0	1,200	2,740	NA
	3-Sep-21	64	<5.0	920	3,030	NA
	28-May-21	120	<5.0	950	3,330	NA
	8-Mar-21	110	<5.0	980	3,440	NA
	7-Dec-20	120	<5.0	990	3,610	NA
	3-Sep-20	120	<5.0	970	3,580	NA
	3-Jun-20	100	<5.0	860	3,370	NA
	19-Feb-20	110	<5.0	950	3,430	NA
	6-Dec-19	110	<5.0	770	3,200	NA
	21-Aug-19	86	<1.0	880	3,040	NA
	24-May-19	87	<5.0	860	2,920	NA
	7-Mar-19	80	<5.0	860	3,030	NA
	30-Nov-18	110	<5.0	910	3,180	NA
	27-Aug-18	90	<5.0	830	3,010	NA
	4-Jun-18	81	<5.0	750	2,900	NA
	28-Feb-18	76	<5.0	700	2,820	NA
	28-Nov-17	70.7	<0.0500	928	2,860	NA
	23-Aug-17	51.1	<0.0500	826	2,910	NA
	9-Jun-17	71.3	<0.100	977	3,360	NA
	10-Mar-17	69.2	<0.0501	939	3,190	NA
	28-Dec-16	NA	NA	NA	2,920	NA
	6-Dec-16	59.9	<0.300	936	3,020 R	NA
	7-Sep-16	58.9	<0.937	1,020	3,180	NA
	6-Jun-16	55.2	<2.24	1,350	2,920	NA
	29-Feb-16	35.6	3.92	815	2,360	NA
	23-Nov-15	6.28	<1.18	708	2,090	NA
	2-Sep-15	4.27	1.40	720	2,100	NA
	27-May-15	6.44	<1.18	609	1,910	NA
	4-Mar-15	5.95	<1.80	487	1,850	NA
	4-Dec-14	5.03	<1.80	465	1,760	NA
	28-Aug-14	13.0	<1.80	520	2,080	NA
	4-Jun-14	15.0	<1.80	532	2,180	NA
18-Mar-14	18.1	<1.66	592	2,140	NA	
16-Dec-13	16.9	<1.66	568	1,890	NA	
5-Sep-13	12.0	4.20	583	1,990	NA	
24-May-13	6.73	<1.66	509	1,960	NA	
6-Mar-13	5.76	<1.72	516	1,910	NA	
4-Dec-12	3.47	<1.72	445	1,720	NA	
20-Aug-12	3.45	<1.72	409	1,660	NA	
10-May-12	1.16	<1.72	364	2,840	NA	
31-Jan-12	6.79	2.94	475	1,620	NA	
7-Dec-11	2.14	<2.17	396	1,600	219	

**TABLE 4. ABATEMENT PLAN MONITORING WELL GROUNDWATER ANALYTICAL RESULTS
DONA ANA DAIRIES, DONA ANA COUNTY, NEW MEXICO**

Monitoring Well	Date Sampled	Nitrate (mg/l)	TKN (mg/l)	Chloride (mg/l)	TDS (mg/l)	Sulfate (mg/l)
DAD-22 Perched Aquifer	14-Dec-23	15	<0.50	820	2,370	NA
	13-Sep-23	14	<2.0	740	2,410	NA
	6-Jun-23	15	<2.0	870	2,360	NA
	9-Mar-23	15	<2.0	870	2,320	NA
	9-Dec-22	16	<2.0	880	2,340	NA
	14-Sep-22	15	<2.0	780	2,420	NA
	2-Jun-22	16	<2.0	880	2,440	440
	23-Mar-22	16	<2.0	780	2,440	NA
	8-Dec-21	14	<2.0	880	2,350	NA
	3-Sep-21	14	<2.0	860	2,430	NA
	28-May-21	11	<2.0	840	2,390	NA
	8-Mar-21	13	<2.0	890	2,360	NA
	7-Dec-20	12	<2.0	870	2,490	NA
	8-Sep-20	12	<2.0	850	2,410	NA
	3-Jun-20	11	<2.0	840	2,460	NA
	19-Feb-20	11	<2.0	870	2,340	NA
	6-Dec-19	6.7	<5.0	780	2,360	NA
	21-Aug-19	17	<1.0	840	2,390	NA
	24-May-19	20	<2.0	770	2,320	NA
	7-Mar-19	26	<5.0	670	2,200	NA
	30-Nov-18	18	<5.0	670	2,120	NA
	24-Aug-18	29	<5.0	700	2,380	NA
	1-Jun-18	20	<2.0	810	2,390	NA
	27-Feb-18	12	<2.0	860	2,420	NA
	28-Nov-17	16.2	<0.0500	4.03	2,250	NA
	23-Aug-17	19.0	<0.0500	803	2,410	NA
	7-Jun-17	22.2	<0.100	846	2,500	NA
	7-Mar-17	27.3	<0.300	817	2,360	NA
	5-Dec-16	25.4	<0.300	808	2,480	NA
	6-Sep-16	23.6	<0.937	863	2,380	NA
	8-Jun-16	21.8	<2.24	815	2,420	NA
	25-Feb-16	18.5	4.48	932	2,380	NA
	23-Nov-15	6.52	<1.18	964	2,340	NA
	2-Sep-15	6.35	<1.18	948	2,500	NA
	27-May-15	6.56	<1.18	920	2,520	NA
	3-Mar-15	6.22	<1.80	884	2,400	NA
	3-Dec-14	6.52	<1.80	915	2,480	NA
	28-Aug-14	6.60	<1.80	810	2,420	NA
	6-Jun-14	6.80	<1.80	906	2,480	NA
	18-Mar-14	6.38	<1.66	846	2,420	NA
13-Dec-13	6.35	<1.66	909	2,440	NA	
5-Sep-13	Did Not Contain Enough Water to Sample					
24-May-13	9.29	<1.66	920	2,580	NA	
6-Mar-13	8.25	<1.72	909	2,610	NA	
4-Dec-12	12.0	<1.72	886	2,740	NA	
20-Aug-12	15.3	2.10	878	2,280	NA	
10-May-12	18.3	<1.72	818	1,580	NA	
1-Feb-12	23.6	<2.17	908	3,000	NA	
26-Oct-11	29.5	2.52	781	3,860	494	

**TABLE 4. ABATEMENT PLAN MONITORING WELL GROUNDWATER ANALYTICAL RESULTS
DONA ANA DAIRIES, DONA ANA COUNTY, NEW MEXICO**

Monitoring Well	Date Sampled	Nitrate (mg/l)	TKN (mg/l)	Chloride (mg/l)	TDS (mg/l)	Sulfate (mg/l)
DAD-26 Perched Aquifer	15-Dec-23	14	<1.2	1,000	3,070	NA
	14-Sep-23	16	<2.0	930	3,030	NA
	6-Jun-23	22	<5.0	610	2,010	NA
	10-Mar-23	23	<5.0	720	2,070	NA
	12-Dec-22	24	<5.0	500	1,740	NA
	14-Sep-22	26	<5.0	490	1,940	NA
	2-Jun-22	26	<5.0	520	1,860	360
	23-Mar-22	22	<5.0	560	1,790	NA
	8-Dec-21	15	<2.0	470	1,610	NA
	7-Sep-21	3.8	<1.0	560	1,820	NA
	28-May-21	10	<2.0	640	2,060	NA
	8-Mar-21	6.8	<1.0	810	2,460	NA
	7-Dec-20	25	<5.0	580	2,010	NA
	8-Sep-20	38	<5.0	640	2,270	NA
	3-Jun-20	35	<5.0	640	2,320	NA
	19-Feb-20	16	<2.0	480	1,680	NA
	6-Dec-19	1.8	<5.0	300	1,060	NA
	21-Aug-19	43	<1.0	700	2,410	NA
	28-May-19	41	<5.0	730	2,360	NA
	7-Mar-19	50	<5.0	800	2,670	NA
	30-Nov-18	48	<5.0	860	2,770	NA
	28-Aug-18	110	<5.0	870	3,020	NA
	4-Jun-18	47	<5.0	920	3,240	NA
	28-Feb-18	59	<5.0	940	3,000	NA
	28-Nov-17	65.1	<0.0500	1,160	3,110	NA
	28-Aug-17	59.8	<0.0500	1,090	3,110	NA
	9-Jun-17	60.5	<0.100	1,090	3,270	NA
	10-Mar-17	66.3	<0.0501	1,110	3,280	NA
28-Dec-16	NA	NA	NA	3,420	NA	
6-Dec-16	69.6	<0.300	1,090	3,160 R	NA	
8-Sep-16	63.2	<0.937	1,030	3,210	NA	
6-Jun-16	67.0	<2.24	858	2,900	NA	
1-Mar-16	61.1	<1.18	837	2,760	NA	
22-Dec-15	59.6	<1.18	749	2,540	NA	
DAD-27 Perched Aquifer	14-Dec-23	6.4	<2.5	450	2,000	NA
	14-Sep-23	6.8	<1.0	450	2,100	NA
	6-Jun-23	7.0	<1.0	490	1,490	NA
	10-Mar-23	5.9	<2.0	460	1,900	NA
	12-Dec-22	6.1	<1.0	470	1,870	NA
NMWQCC Standard		10	NA	250	1,000	600
Existing Conditions - August 2020		NA	NA	455	1,424	NA
Existing Conditions - Pre-August 2020*		NA	NA	503	2,552	NA

Notes:

Data suspect

* = Pre-August 2020 existing conditions were in place prior to August 2020. This condition is no longer applicable.

NA = Not analyzed

ND = Non detect

NMWQCC = New Mexico Water Quality Control Commission

TDS = Total dissolved solids

R = Rejected. Analyzed out of hold time.

TKN = Total Kjeldahl Nitrogen

DAD-03 (6-29-10) Roots in sample may have resulted in a measured TKN result.

Data from current quarter.

Highlight is at or above NMWQCC Standard.

Highlight is at or above relevant existing conditions value. Applicable to samples collected in or after August 2020.

**TABLE 5. DISCHARGE PLAN MONITORING WELL GROUNDWATER ANALYTICAL RESULTS
DONA ANA DAIRIES, DONA ANA COUNTY, NEW MEXICO**

Monitoring Well	Date Sampled	Nitrate as N (mg/l)	TKN (mg/l)	Chloride (mg/l)	TDS (mg/l)
Northern Area					
Northern Land Application Area					
70-03	9-Nov-23	38	1.1	1,700	4,520
	9-Aug-23	38	<5.0	1,600	4,400
	8-May-23	39	<5.0	1,500	4,640
	9-Feb-23	39	<5.0	1,800	4,140
	8-Nov-22	41	<5.0	1,900	4,690
	9-Aug-22	39	<5.0	1,600	4,750
	9-May-22	37	<5.0	1,500	4,430
	15-Feb-22	38	<5.0	1,600	4,240
	5-Nov-21	39	<5.0	1,800	4,600
	10-Aug-21	41	<5.0	1,800	4,770
	10-May-21	40	<5.0	1,800	4,760
	16-Feb-21	41	<5.0	1,700	4,600
	11-Nov-20	43	<5.0	1,900	5,050
	14-Aug-20	47	<5.0	2,100	5,590
	13-May-20	50	<5.0	2,200	5,810
	7-Feb-20	50	<1.0	2,400	6,080
	15-Nov-19	48	<5.0	2,200	6,350
	6-Aug-19	53	<2.0	2,800	6,810
	16-May-19	50	<5.0	3,100	6,850
	26-Feb-19	51	<5.0	3,000	7,320
	15-Nov-18	52	<5.0	3,300	7,530
	15-Aug-18	50	<5.0	3,100	7,900
	21-May-18	50	<5.0	3,200	8,080
	13-Feb-18	46	<5.0	3,400	8,490
	9-Nov-17	44.7	1.26	3,320	7,940
	14-Aug-17	45.4	1.89	3,380	8,370
	19-May-17	43.5	0.539	3,330	8,370
	20-Feb-17	43.6	<0.0501	3,200	8,270
	22-Nov-16	43.4	<0.300	3,250	8,430
	18-Aug-16	45.2	<0.937	6,010	9,340
	24-May-16	47.4	<2.24	3,220	8,330
	16-Feb-16	49.1	<1.18	3,340	8,380
	12-Nov-15	46.9	4.48	2,850	7,040
	19-Aug-15	47.4	<1.18	2,510	6,760
	12-May-15	47.0	1.40	3,060	7,900
	10-Feb-15	34.8	<1.80	744	6,140
	14-Nov-14	49.1	<1.80	2,530	6,360
	20-Aug-14	49.8	<1.80	2,590	7,000
	15-May-14	48.6	<1.80	2,580	6,880
	19-Feb-14	57.1	<1.66	3,400	8,380
14-Nov-13	45.4	3.50	2,680	6,800	
9-Aug-13	48.7	3.50	2,740	6,890	
9-May-13	58.4	<1.66	3,290	9,200	
13-Feb-13	59.1	<1.72	3,400	8,440	
7-Nov-12	49.5	<1.72	2,850	7,950	
7-Aug-12	45.3	2.94	2,440	6,700	
25-Apr-12	53.1	5.60	2,540	6,550	
2-Feb-12	67.6	<2.17	2,840	7,480	
7-Nov-11	61.6	<2.17	3,270	7,910	
3-Aug-11	63.1	2.80	3,140	8,040	
21-Apr-11	58.9	<2.17	3,130	8,040	
27-Jan-11	71.2	3.36	3,140	7,580	
22-Sep-10	62.8	<10.0	2,940	7,840	
30-Jun-10	57	<1.0	2,200	5,720	
26-Mar-10	29.6	ND	2,160	5,180	
15-Dec-09	27.1	ND	2,199	5,462	
2-Sep-09	25.4	ND	2,149	5,570	
4-Jun-09	18.6	ND	1,999	5,518	
4-Mar-09	35.5	ND	2,074	5,418	

**TABLE 5. DISCHARGE PLAN MONITORING WELL GROUNDWATER ANALYTICAL RESULTS
DONA ANA DAIRIES, DONA ANA COUNTY, NEW MEXICO**

Monitoring Well	Date Sampled	Nitrate as N (mg/l)	TKN (mg/l)	Chloride (mg/l)	TDS (mg/l)
70/86/340-01	8-Nov-23	33	0.54	1,900	6,290
	8-Aug-23	69	<5.0	2,400	7,090
	5-May-23	24	<5.0	1,900	6,060
	8-Feb-23	29	<5.0	2,000	6,560
	7-Nov-22	27	<5.0	1,800	6,570
	8-Aug-22	20	<5.0	1,900	6,250
	5-May-22	20	<5.0	1,900	6,120
	14-Feb-22	20	<5.0	1,700	5,440
	4-Nov-21	20	<5.0	1,500	4,260
	9-Aug-21	3.9	<1.0	1,000	3,060
	6-May-21	7.9	<1.0	1,300	3,550
	15-Feb-21	9.8	<1.0	1,500	3,790
	11-Nov-20	12	<2.0	1,700	4,320
	13-Aug-20	18	<1.0	1,600	4,500
	18-May-20	18	<2.0	1,800	4,520
	7-Feb-20	22	<5.0	1,700	4,590
	15-Nov-19	22	<1.0	1,500	4,660
	7-Aug-19	23	<5.0	1,700	4,720
	16-May-19	23	<5.0	1,800	4,720
	25-Feb-19	21	<5.0	1,700	4,750
	16-Nov-18	23	<5.0	1,700	4,560
	14-Aug-18	19	<2.0	1,700	4,680
	21-May-18	18	<2.0	1,600	4,600
	12-Feb-18	19	<2.0	1,500	4,580
	9-Nov-17	19.6	0.750	1,510	4,190
	11-Aug-17	20.6	0.868	1,790	5,170
	18-May-17	20.3	0.665	1,730	5,410
	16-Feb-17	30.1	<0.0501	1,350	4,430
	10-Nov-16	22.6	1.14	817	5,080
	23-Aug-16	24.1	<0.937	3,450	5,170
	19-May-16	17.3	6.92	1,630	4,680
	15-Feb-16	12.1	<1.18	1,750	4,730
	10-Nov-15	16.0	<1.18	1,740	4,940
	20-Aug-15	8.66	2.80	1,790	4,860
	11-May-15	8.19	<1.18	1,780	4,780
	9-Feb-15	8.79	<1.80	1,620	4,840
	12-Nov-14	15.6	<1.80	2,090	6,320
	15-Aug-14	15.3	<1.80	1,730	5,780
	11-Nov-13	6.65	4.90	1,760	4,780
	8-Aug-13	15.1	3.50	2,190	6,920
9-May-13	15.1	<1.66	1,930	6,650	
13-Feb-13	16.6	<1.72	2,170	6,660	
5-Nov-12	12.7	<1.72	2,120	4,940	
6-Aug-12	17.1	<1.72	1,870	6,400	
25-Apr-12	11.8	<1.72	1,620	4,280	
2-Feb-12	20.0	8.12	1,750	5,440	
7-Nov-11	25.5	4.76	1,970	5,920	
25-Jul-11	31.0	2.24	1,800	5,500	
21-Apr-11	35.0	<2.17	1,780	5,420	
27-Jan-11	53.5	<2.17	1,370	4,420	
22-Sep-10	39.8	<10.0	1,130	4,000	
30-Jun-10	52	<1.0	1,300	4,090	
26-Mar-10	53	ND	1,200	3,616	
15-Dec-09	64	ND	1,080	3,408	
2-Sep-09	50	ND	1,100	3,610	
4-Jun-09	28	ND	1,410	4,340	
4-Mar-09	39.3	ND	1,150	3,820	

**TABLE 5. DISCHARGE PLAN MONITORING WELL GROUNDWATER ANALYTICAL RESULTS
DONA ANA DAIRIES, DONA ANA COUNTY, NEW MEXICO**

Monitoring Well	Date Sampled	Nitrate as N (mg/l)	TKN (mg/l)	Chloride (mg/l)	TDS (mg/l)
86/340-01	8-Nov-23	2.3	<0.50	260	2,250
	8-Aug-23	2.5	<1.0	260	2,280
	5-May-23	2.9	<1.0	270	2,220
	8-Feb-23	3.2	<1.0	260	2,210
	7-Nov-22	2.9	<1.0	230	2,190
	8-Aug-22	3.4	<1.0	240	2,190
	5-May-22	3.1	<1.0	220	2,150
	14-Feb-22	3.2	<1.0	230	2,170
	4-Nov-21	3.1	<1.0	260	2,190
	9-Aug-21	2.8	<1.0	240	2,190
	6-May-21	3.2	<1.0	230	1,890
	15-Feb-21	2.9	<5.0	240	2,120
	11-Nov-20	3.4	<1.0	200	2,080
	13-Aug-20	3.6	<2.0	220	2,030
	18-May-20	5.1	<1.0	250	2,010
	7-Feb-20	4.7	<1.0	230	1,990
	15-Nov-19	5.0	<1.0	210	2,010
	7-Aug-19	5.9	<1.0	240	1,940
	16-May-19	7.5	<1.0	260	1,930
	25-Feb-19	7.0	<1.0	250	1,910
	16-Nov-18	7.0	<1.0	240	1,900
	14-Aug-18	7.4	<1.0	230	1,890
	21-May-18	8.3	<1.0	240	1,890
	12-Feb-18	9.6	<1.0	300	1,920
	9-Nov-17	10.5	<0.0500	293	1,670
	11-Aug-17	11.9	<0.0500	338	2,030
	18-May-17	13.4	<0.0501	445	2,410
	16-Feb-17	13.1	<0.0501	387	2,240
	10-Nov-16	11.6	<0.937	384	2,200
	23-Aug-16	12.1	<0.937	408	2,210
	19-May-16	11.2	<2.24	421	2,220
	15-Feb-16	12.9	<1.18	422	2,300
	10-Nov-15	11.7	2.24	421	2,260
	20-Aug-15	11.7	<1.18	416	2,150
	11-May-15	12.4	<1.18	450	2,240
	9-Feb-15	10.8	<1.80	410	2,120
	11-Nov-14	11.3	<1.80	398	2,180
	15-Aug-14	11.6	<1.80	400	2,300
	14-May-14	15.4	<1.80	500	2,380
	18-Feb-14	12.4	<1.66	460	2,370
	11-Nov-13	12.2	7.00	641	2,940
	8-Aug-13	12.1	2.10	720	3,230
	9-May-13	12.3	<1.66	603	3,020
	13-Feb-13	12.2	<1.72	571	2,780
	5-Nov-12	12.1	<1.72	638	2,860
	6-Aug-12	11.6	<1.72	708	3,410
	25-Apr-12	12.1	<1.72	641	2,480
	2-Feb-12	12.3	<2.17	655	2,960
	7-Nov-11	11.6	3.08	593	2,910
	25-Jul-11	10.2	<2.17	582	2,500
	21-Apr-11	10.4	<2.17	512	2,660
	27-Jan-11	7.99	<2.17	419	2,040
	22-Sep-10	11.8	<10.0	331	2,060
	30-Jun-10	13	<1.0	410	2,190
	26-Mar-10	9.2	0.7	690	2,656
	29-Jan-10	8.6	ND	530	2,258
	2-Sep-09	8.8	ND	510	2,232
	4-Jun-09	5.2	1.12	640	2,582
	4-Mar-09	11.9	ND	675	2,674

**TABLE 5. DISCHARGE PLAN MONITORING WELL GROUNDWATER ANALYTICAL RESULTS
DONA ANA DAIRIES, DONA ANA COUNTY, NEW MEXICO**

Monitoring Well	Date Sampled	Nitrate as N (mg/l)	TKN (mg/l)	Chloride (mg/l)	TDS (mg/l)
Organ Dairy (Formerly known as Del Norte Dairy and Daybreak Dairy)					
126-04	20-Nov-23	Not Sampled - insufficient water to sample			
	27-Aug-23	Not Sampled - insufficient water to sample			
	24-May-23	Not Sampled - insufficient water to sample			
	11-Jan-23	Not Sampled - insufficient water to sample			
	8-Nov-22	Not Sampled - insufficient water to sample			
	17-Aug-22	Not Sampled - insufficient water to sample			
	5-May-22	25	<5.0	750	3,130
	24-Feb-22	23	<5.0	770	3,110
	9-Nov-21	25	<5.0	810	1,530
	11-Aug-21	28	<5.0	800	2,930
	4-May-21	26	<5.0	790	3,170
	9-Feb-21	27	<5.0	760	3,200
	10-Nov-20	28	<5.0	780	3,120
	12-Aug-20	29	<5.0	790	2,980
	13-May-20	25	<5.0	680	2,620
	10-Feb-20	25	<5.0	680	2,580
	12-Nov-19	26	<5.0	670	2,600
	5-Aug-19	23	<5.0	620	2,420
	14-May-19	22	<5.0	630	2,400
	22-Feb-19	24	<5.0	650	2,370
	14-Nov-18	23	<5.0	610	2,530
	15-Aug-18	19	<2.0	580	2,400
	18-May-18	21	<5.0	570	2,360
	9-Feb-18	22	<2.0	620	2,530
	8-Nov-17	22.1	<0.0500	661	2,510
	10-Aug-17	19.4	0.871	614	2,550
	17-May-17	19.7	0.356	606	2,600
	17-Feb-17	20.7	<0.0501	639	2,680
	9-Nov-16	18.5	<0.937	621	2,580
	17-Aug-16	16.1	1.12	516	2,560
	18-May-16	16.7	<2.24	580	2,460
	15-Feb-16	20.2	4.48	623	2,510
	9-Nov-15	19.2	<1.18	612	2,460
	17-Aug-15	18.4	<1.18	573	2,490
	13-May-15	17.9	4.20	575	2,560
	11-Feb-15	17.1	<1.80	572	2,450
	12-Nov-14	16.4	7.70	556	2,400
	18-Aug-14	15.1	<1.80	536	2,590
	15-May-14	17.4	16.1	514	2,200
	20-Feb-14	17.1	<1.66	564	2,410
13-Nov-13	16.7	9.10	567	2,240	
12-Aug-13	15.3	18.2	511	2,170	
10-May-13	15.1	<1.66	499	2,310	
12-Feb-13	18.5	<1.72	614	2,640	
7-Nov-12	16.0	3.50	572	2,500	
7-Aug-12	15.9	2.10	568	2,370	
30-Apr-12	15.7	<1.72	539	2,310	
26-Jan-12	17.4	<2.17	560	1,700	
7-Nov-11	18.2	3.92	581	2,470	
3-Aug-11	18.2	6.44	559	2,460	
22-Apr-11	18.0	5.74	594	2,500	
26-Jan-11	11.1	<2.17	570	2,380	
21-Sep-10	20.5	<10.0	542	2,460	
30-Jun-10	21	<5.0	490	2,160	
25-Mar-10	14.9	0.56	530	1,964	
15-Dec-09	11.5	ND	550	1,974	
2-Sep-09	9	ND	530	2,028	
4-Jun-09	5.81	ND	550	2,084	
5-Mar-09	14.1	ND	525	2,122	

**TABLE 5. DISCHARGE PLAN MONITORING WELL GROUNDWATER ANALYTICAL RESULTS
DONA ANA DAIRIES, DONA ANA COUNTY, NEW MEXICO**

Monitoring Well	Date Sampled	Nitrate as N (mg/l)	TKN (mg/l)	Chloride (mg/l)	TDS (mg/l)
126-05	20-Nov-23	Not Sampled - insufficient water to sample			
	27-Aug-23	Not Sampled - insufficient water to sample			
	24-May-23	Not Sampled - insufficient water to sample			
	11-Jan-23	Not Sampled - insufficient water to sample			
	8-Nov-22	Not Sampled - insufficient water to sample			
	17-Aug-22	Not Sampled - insufficient water to sample			
	5-May-22	9.0	1.3	660	3,220
	24-Feb-22	10	<2.0	710	3,270
	9-Nov-21	11	<2.0	750	3,380
	11-Aug-21	11	<2.0	790	3,480
	4-May-21	11	<2.0	730	3,380
	9-Feb-21	13	<2.0	780	3,710
	10-Nov-20	14	<2.0	1,000	3,670
	12-Aug-20	15	<2.0	740	3,220
	13-May-20	10	2.20	820	3,590
	10-Feb-20	13	<2.0	900	3,800
	12-Nov-19	15	<2.0	930	3,860
	5-Aug-19	16	<2.0	750	3,490
	14-May-19	17	<2.0	800	3,520
	22-Feb-19	18	<2.0	950	3,810
	14-Nov-18	20	<5.0	890	3,840
	15-Aug-18	23	<5.0	860	3,590
	18-May-18	23	<5.0	840	3,790
	9-Feb-18	26	<2.0	960	3,800
	8-Nov-17	26.6	0.196	860	3,510
	10-Aug-17	25.4	2.17	814	3,460
	17-May-17	28.1	1.20	856	3,600
	17-Feb-17	28.5	4.95	852	3,580
	9-Nov-16	41.9	<0.937	769	3,510
	18-Aug-16	20.5	<0.937	572	3,120
	18-May-16	24.2	<2.24	728	3,130
	15-Feb-16	27.7	1.68	792	3,190
	9-Nov-15	20.2	<1.18	643	2,980
	17-Aug-15	18.8	<1.18	627	2,860
	12-May-15	17.6	2.10	670	3,000
	11-Feb-15	28.8	<1.80	713	3,470
	12-Nov-14	19.2	5.60	746	3,500
	18-Aug-14	16.4	<1.80	575	3,080
	15-May-14	23.0	4.90	637	2,960
	20-Feb-14	27.1	<1.66	643	3,140
	13-Nov-13	30.3	4.20	648	3,100
12-Aug-13	33.9	4.20	594	2,920	
10-May-13	39.0	<1.66	635	3,060	
12-Feb-13	34.2	<1.72	618	3,180	
7-Nov-12	29.2	<1.72	548	2,890	
7-Aug-12	30.8	2.10	548	2,860	
30-Apr-12	28.6	2.38	530	2,840	
26-Jan-12	30.1	<2.17	546	2,520	
4-Nov-11	31.2	<2.17	543	3,510	
4-Aug-11	29.5	4.20	525	2,540	
22-Apr-11	28.0	2.80	615	2,800	
26-Jan-11	25.2	3.64	553	2,870	
21-Sep-10	22.3	<10.0	504	2,240	
30-Jun-10	24	<5.0	540	2,750	
25-Mar-10	13.5	ND	640	2,736	
15-Dec-09	16.6	ND	630	2,554	
2-Sep-09	12.8	1.4	580	2,566	
4-Jun-09	10.1	ND	600	2,640	
5-Mar-09	19.9	1.03	610	2,828	

**TABLE 5. DISCHARGE PLAN MONITORING WELL GROUNDWATER ANALYTICAL RESULTS
DONA ANA DAIRIES, DONA ANA COUNTY, NEW MEXICO**

Monitoring Well	Date Sampled	Nitrate as N (mg/l)	TKN (mg/l)	Chloride (mg/l)	TDS (mg/l)
126-07	20-Nov-23	Not Sampled - insufficient water to sample			
	27-Aug-23	Not Sampled - insufficient water to sample			
	24-May-23	Not Sampled - insufficient water to sample			
	11-Jan-23	Not Sampled - insufficient water to sample			
	8-Nov-22	Not Sampled - insufficient water to sample			
	17-Aug-22	Not Sampled - insufficient water to sample			
	5-May-22	21	<5.0	790	3,470
	24-Feb-22	22	<5.0	870	3,550
	9-Nov-21	22	<5.0	910	3,480
	11-Aug-21	23	<5.0	890	3,430
	4-May-21	22	<5.0	790	3,390
	9-Feb-21	25	<5.0	770	3,400
	10-Nov-20	26	<5.0	860	3,340
	12-Aug-20	28	<5.0	830	3,310
	13-May-20	25	<5.0	780	3,290
	7-Feb-20	28	<5.0	780	3,230
	12-Nov-19	28	<5.0	770	3,150
	5-Aug-19	29	<5.0	800	3,150
	14-May-19	28	<5.0	790	3,110
	22-Feb-19	30	<5.0	790	3,030
	14-Nov-18	27	<5.0	790	2,990
	15-Aug-18	22	<1.0	720	2,900
	18-May-18	22	<5.0	660	2,740
	9-Feb-18	21	<2.0	690	2,760
	8-Nov-17	22.4	<0.0500	701	2,630
	10-Aug-17	21.6	<0.0500	723	2,540
	17-May-17	22.3	<0.0501	702	2,510
	17-Feb-17	23.9	<0.0501	663	2,590
	9-Nov-16	27.2	<0.937	526	2,540
	18-Aug-16	28.2	<0.937	523	2,510
	18-May-16	28.5	<2.24	607	2,380
	15-Feb-16	27.0	<1.18	579	2,460
	9-Nov-15	26.5	6.16	571	2,380
	17-Aug-15	23.0	<1.18	559	2,610
	13-May-15	17.9	4.20	575	2,560
	11-Feb-15	24.0	<1.80	546	2,590
	12-Nov-14	23.4	<1.80	586	2,710
	18-Aug-14	21.8	<1.80	565	2,510
	16-May-14	24.8	4.90	583	2,170
	20-Feb-14	25.6	<1.66	615	2,490
	13-Nov-13	24.1	4.20	615	2,330
	12-Aug-13	23.5	5.60	586	2,410
10-May-13	20.2	<1.66	573	2,620	
12-Feb-13	21.2	<1.72	648	2,740	
7-Nov-12	19.8	<1.72	629	2,870	
7-Aug-12	19.5	2.10	650	2,610	
30-Apr-12	18.8	<1.72	605	2,710	
26-Jan-12	18.8	2.24	666	2,790	
4-Nov-11	19.8	<2.17	668	2,270	
4-Aug-11	19.1	2.24	666	1,410	
22-Apr-11	21.2	<2.17	704	3,110	
27-Jan-11	22.4	<2.17	662	2,670	
21-Sep-10	24.9	<10.0	700	2,800	
30-Jun-10	26	<5.0	760	2,780	
25-Mar-10	12.1	ND	610	2,238	
15-Dec-09	13.8	ND	720	2,412	
2-Sep-09	10.9	ND	820	2,716	
4-Jun-09	19.0	ND	810	2,468	
5-Mar-09	16.8	ND	605	2,230	

**TABLE 5. DISCHARGE PLAN MONITORING WELL GROUNDWATER ANALYTICAL RESULTS
DONA ANA DAIRIES, DONA ANA COUNTY, NEW MEXICO**

Monitoring Well	Date Sampled	Nitrate as N (mg/l)	TKN (mg/l)	Chloride (mg/l)	TDS (mg/l)
126-09	20-Nov-23	Not Sampled - insufficient water to sample			
	27-Aug-23	Not Sampled - insufficient water to sample			
	24-May-23	Not Sampled - insufficient water to sample			
	11-Jan-23	Not Sampled - insufficient water to sample			
	8-Nov-22	Not Sampled - insufficient water to sample			
	17-Aug-22	Not Sampled - insufficient water to sample			
	5-May-22	1.4	<1.0	190	924
	24-Feb-22	1.0	<1.0	150	856
	9-Nov-21	Not Sampled - insufficient water to sample			
	11-Aug-21	Not Sampled - insufficient water to sample			
	4-May-21	Not Sampled - insufficient water to sample			
	9-Feb-21	Not Sampled - insufficient water to sample			
	10-Nov-20	1.2	<1.0	200	865
	12-Aug-20	Not Sampled - insufficient water to sample			
	14-May-20	Not Sampled - insufficient water to sample			
	7-Feb-20	Not Sampled - insufficient water to sample			
	12-Nov-19	<1.0	<1.0	150	824
	5-Aug-19	1.1	<2.0	200	898
	14-May-19	<1.0	<2.0	160	815
	22-Feb-19	<1.0	<1.0	200	888
	14-Nov-18	<1.0	<1.0	140	764
	15-Aug-18	<1.0	<1.0	110	722
	18-May-18	<1.0	<1.0	150	742
	9-Feb-18	<1.0	<1.0	120	732
	8-Nov-17	1.65	0.538	66.7	555
	10-Aug-17	0.218	0.452	70.0	740
	17-May-17	0.230	<0.0501	67.1	640
	20-Feb-17	0.269	1.80	89.5	775
	9-Nov-16	2.39	<0.937	824	2,440
	18-Aug-16	1.41	2.25	714	2,500
	18-May-16	6.35	<2.24	794	2,440
	15-Feb-16	1.73	<1.18	879	2,660
	9-Nov-15	1.47	6.16	879	2,860
	17-Aug-15	1.40	<1.18	880	2,850
	13-May-15	2.34	<1.18	873	2,500
	11-Feb-15	2.18	<1.80	798	2,740
	13-Nov-14	2.42	<1.80	842	2,500
	18-Aug-14	2.25	<1.80	832	2,840
	15-May-14	2.52	<1.80	893	2,690
	20-Feb-14	2.12	<1.66	911	2,720
13-Nov-13	2.25	4.20	919	2,710	
12-Aug-13	2.13	5.60	937	2,710	
10-May-13	2.25	<1.66	898	3,300	
12-Feb-13	2.50	<1.72	991	3,090	
7-Nov-12	2.53	<1.72	984	2,980	
7-Aug-12	2.69	2.10	962	3,050	
30-Apr-12	2.28	5.04	978	2,900	
26-Jan-12	3.93	7.00	1,100	3,180	
7-Nov-11	3.30	5.6	1,130	3,470	
4-Aug-11	3.19	<2.17	1,100	3,180	
22-Apr-11	3.31	<2.17	1,120	2,730	
22-Sep-10	2.50	<10.0	1,110	3,320	
30-Jun-10	Not Sampled				
25-Mar-10	Not Sampled				
15-Dec-09	Not Sampled				
2-Sep-09	Not Sampled				
4-Jun-09	Not Sampled				
5-Mar-09	Not Sampled				

**TABLE 5. DISCHARGE PLAN MONITORING WELL GROUNDWATER ANALYTICAL RESULTS
DONA ANA DAIRIES, DONA ANA COUNTY, NEW MEXICO**

Monitoring Well	Date Sampled	Nitrate as N (mg/l)	TKN (mg/l)	Chloride (mg/l)	TDS (mg/l)
126-12	19-Nov-23	3.8	0.64	430	2,140
	27-Aug-23	4.3	<1.0	450	1,120
	24-May-23	3.2	1.4	400	2,110
	11-Jan-23	4.3	<1.0	420	2,210
	8-Nov-22	3.4	<1.0	430	2,160
	17-Aug-22	3.8	<1.0	410	2,200
	5-May-22	3.8	<1.0	360	2,120
	24-Feb-22	4.6	<1.0	420	2,180
	9-Nov-21	4.6	<1.0	390	2,120
	11-Aug-21	6.7	<1.0	430	2,170
	4-May-21	6.9	<1.0	370	2,220
	9-Feb-21	6.0	<1.0	350	2,220
	10-Nov-20	8.9	<1.0	400	2,240
	12-Aug-20	11	<2.0	420	2,350
	12-Aug-20	11	<2.0	420	2,260
	14-May-20	6.4	<1.0	350	2,190
	10-Feb-20	2.8	<1.0	310	2,100
	12-Nov-19	8.3	<1.0	350	2,200
	5-Aug-19	13	<2.0	370	2,270
	14-May-19	8.1	<2.0	350	2,180
	22-Feb-19	8.2	1.3	370	2,270
	14-Nov-18	13	<2.0	390	2,300
	15-Aug-18	17	2.5	430	2,500
	7-Jun-18	11	2.2	420	2,550
	9-Feb-18	3.9	4.5	420	2,430
	8-Nov-17	3.26	16.6	24.5	2,440
	10-Aug-17	7.40	4.90	520	2,780
	17-May-17	17.6	0.476	455	2,480
	20-Feb-17	13.0	1.09	420	2,430
	9-Nov-16	17.1	<0.937	430	2,520
	18-Aug-16	19.4	<0.937	363	2,580
	18-May-16	17.6	<2.24	391	2,310
	15-Feb-16	13.9	<1.18	416	2,450
	9-Nov-15	10.8	8.96	428	2,460
	17-Aug-15	3.49	10.5	407	2,240
	12-May-15	2.43	11.2	393	2,120
	10-Feb-15	<0.0137	29.4	632	2,190
	13-Nov-14	2.57	2.80	409	2,160
	18-Aug-14	16.5	<1.80	384	2,220
	15-May-14	15.4	2.10	404	2,250
	20-Feb-14	13.6	2.10	404	2,370
	13-Nov-13	15.7	3.50	401	2,360
12-Aug-13	17.0	4.20	434	2,400	
10-May-13	16.2	2.10	398	2,380	
12-Feb-13	18.8	<1.72	421	2,480	
7-Nov-12	19.2	<1.72	407	2,490	
7-Aug-12	17.5	<1.72	410	2,460	
30-Apr-12	12.9	1.96	401	2,270	
14-Feb-12	12.5	4.20	418	2,340	
4-Nov-11	13.3	<2.17	430	2,600	
4-Aug-11	13.6	<2.17	449	2,580	
22-Apr-11	13.2	<2.17	461	2,530	
27-Jan-11	12.2	<2.17	453	2,280	
22-Sep-10	12.6	<10.0	446	2,430	
30-Jun-10	15	<2.0	500	2,610	
25-Mar-10	8.9	ND	550	2,260	
15-Dec-09	8.7	ND	540	2,296	
2-Sep-09	12.8	0.56	530	2,336	
4-Jun-09	4.08	0.84	530	2,322	
5-Mar-09	11	ND	475	2,320	

**TABLE 5. DISCHARGE PLAN MONITORING WELL GROUNDWATER ANALYTICAL RESULTS
DONA ANA DAIRIES, DONA ANA COUNTY, NEW MEXICO**

Monitoring Well	Date Sampled	Nitrate as N (mg/l)	TKN (mg/l)	Chloride (mg/l)	TDS (mg/l)
126-13	19-Nov-23	14	0.76	710	3,110
	27-Aug-23	14	<2.0	710	645
	24-May-23	14	<2.0	710	3,160
	11-Jan-23	14	<2.0	700	1,600
	8-Nov-22	14	<2.0	720	3,210
	17-Aug-22	14	<2.0	690	3,210
	5-May-22	14	<2.0	700	3,330
	24-Feb-22	15	<2.0	760	3,380
	9-Nov-21	16	<2.0	780	3,320
	11-Aug-21	18	<2.0	830	3,360
	4-May-21	17	<2.0	780	3,420
	9-Feb-21	19	<2.0	740	3,440
	10-Nov-20	20	<2.0	780	3,390
	12-Aug-20	23	<5.0	860	3,520
	13-May-20	26	<5.0	860	3,860
	7-Feb-20	34	<5.0	880	3,640
	12-Nov-19	32	<5.0	830	3,730
	5-Aug-19	32	<5.0	900	3,790
	14-May-19	36	<5.0	970	3,570
	22-Feb-19	39	<5.0	990	3,620
	14-Nov-18	42	<5.0	950	3,420
	15-Aug-18	40	<5.0	890	3,670
	18-May-18	37	<5.0	890	3,250
	9-Feb-18	31	<2.0	820	3,330
	8-Nov-17	28.6	0.580	771	2,810
	10-Aug-17	24.4	0.153	784	3,080
	17-May-17	23.2	<0.0501	796	3,180
	17-Feb-17	23.8	<0.0501	869	3,920
	9-Nov-16	23.2	<0.937	594	3,090
	18-Aug-16	23.4	<0.937	703	3,090
	18-May-16	26.1	<2.24	799	3,000
	15-Feb-16	36.9	<1.18	891	2,960
	9-Nov-15	29.6	<1.18	760	2,850
	17-Aug-15	33.3	<1.18	876	3,100
	12-May-15	40.8	1.40	877	3,210
	10-Feb-15	34.7	2.80	776	2,770
	12-Nov-14	33.9	<1.80	801	2,940
	18-Aug-14	38.2	<1.80	809	3,160
	15-May-14	49.5	<1.80	841	3,010
	20-Feb-14	29.9	<1.66	769	2,780
13-Nov-13	28.0	2.80	655	2,980	
12-Aug-13	26.8	3.50	780	2,800	
10-May-13	34.1	<1.66	385	3,160	
12-Feb-13	33.7	<1.72	735	2,840	
7-Nov-12	23.8	2.10	751	3,090	
7-Aug-12	26.1	2.10	779	2,860	
30-Apr-12	43.8	<1.72	784	3,120	
26-Jan-12	27.5	<2.17	735	2,800	
7-Nov-11	21.9	<2.17	735	3,060	
4-Aug-11	21.4	<2.17	735	2,840	
22-Apr-11	21.7	<2.17	754	2,640	
26-Jan-11	22.8	<2.17	768	3,130	
22-Sep-10	23.1	<10.0	750	2,850	
30-Jun-10	26	<5.0	810	3,000	
25-Mar-10	10.3	ND	940	2,740	
15-Dec-09	14.3	ND	910	2,832	
2-Sep-09	12.8	ND	840	2,746	
4-Jun-09	16.3	ND	970	2,768	
5-Mar-09	19.4	ND	845	2,800	

**TABLE 5. DISCHARGE PLAN MONITORING WELL GROUNDWATER ANALYTICAL RESULTS
DONA ANA DAIRIES, DONA ANA COUNTY, NEW MEXICO**

Monitoring Well	Date Sampled	Nitrate as N (mg/l)	TKN (mg/l)	Chloride (mg/l)	TDS (mg/l)
Mountain View Dairy					
70-01	9-Nov-23	14	0.71	680	3,180
	9-Aug-23	13	<2.0	640	3,180
	8-May-23	13	<2.0	770	3,100
	9-Feb-23	17	<2.0	720	3,160
	8-Nov-22	17	2.2	700	3,180
	9-Aug-22	16	<2.0	690	3,350
	9-May-22	15	<2.0	700	3,330
	15-Feb-22	20	<5.0	690	3,170
	5-Nov-21	20	<5.0	850	3,320
	10-Aug-21	23	<5.0	750	3,130
	10-May-21	22	<5.0	750	3,180
	16-Feb-21	23	<5.0	800	3,140
	12-Nov-20	26	<5.0	720	3,030
	14-Aug-20	27	<5.0	770	3,150
	13-May-20	27	<5.0	710	3,000
	10-Feb-20	28	<5.0	770	3,210
	15-Nov-19	29	<5.0	770	3,460
	7-Aug-19	31	<5.0	850	3,450
	16-May-19	34	<5.0	850	3,370
	26-Feb-19	33	<5.0	840	3,390
	15-Nov-18	32	<5.0	770	3,080
	15-Aug-18	37	<5.0	900	3,530
	21-May-18	39	<5.0	860	3,410
	13-Feb-18	30	<5.0	810	3,010
	9-Nov-17	25.6	0.113	687	2,620
	14-Aug-17	24.3	0.290	723	2,740
	19-May-17	22.4	<0.0501	660	2,540
	20-Feb-17	21.8	<0.0501	643	2,530
	22-Nov-16	20.8	<0.300	696	2,790
	19-Aug-16	23.5	<0.937	532	2,740
	24-May-16	22.8	<2.24	629	2,720
	16-Feb-16	25.6	1.68	673	2,650
	12-Nov-15	26.0	5.04	630	2,560
	19-Aug-15	34.5	5.60	812	2,660
	12-May-15	23.2	9.10	597	2,520
	10-Feb-15	22.5	10.5	594	2,560
	17-Nov-14	22.0	<1.80	621	2,620
	20-Aug-14	22.5	<1.80	596	2,610
	15-May-14	23.3	2.10	632	2,540
	19-Feb-14	22.6	<1.66	616	2,620
14-Nov-13	22.3	3.50	510	2,620	
8-Aug-13	22.8	2.80	638	2,670	
9-May-13	22.4	<1.66	616	2,740	
13-Feb-13	24.7	<1.72	655	2,680	
7-Nov-12	21.2	<1.72	636	2,700	
7-Aug-12	21.4	2.10	637	2,700	
25-Apr-12	21.7	<1.72	659	2,490	
2-Feb-12	21.5	2.94	633	2,530	
7-Nov-11	21.1	5.18	622	1,860	
3-Aug-11	20.7	2.8	641	2,630	
22-Apr-11	22.7	22.4	646	2,760	
27-Jan-11	22.5	2.94	650	2,500	
22-Sep-10	19.3	12.3	617	2,610	
30-Jun-10	27	<1.0	600	2,400	
25-Mar-10	14.5	ND	670	2,096	
15-Dec-09	17.1	ND	640	2,218	
1-Sep-09	8.4	ND	630	2,244	
2-Jun-09	9.35	ND	640	2,112	
4-Mar-09	20.8	ND	610	2,254	

**TABLE 5. DISCHARGE PLAN MONITORING WELL GROUNDWATER ANALYTICAL RESULTS
DONA ANA DAIRIES, DONA ANA COUNTY, NEW MEXICO**

Monitoring Well	Date Sampled	Nitrate as N (mg/l)	TKN (mg/l)	Chloride (mg/l)	TDS (mg/l)
70-02	9-Nov-23	Not Sampled - insufficient water to sample			
	9-Aug-23	24	<5.0	580	2,910
	8-May-23	29	<5.0	740	2,890
	9-Feb-23	32	<5.0	920	2,920
	8-Nov-22	31	<5.0	830	2,840
	9-Aug-22	33	<5.0	740	2,980
	9-May-22	33	<5.0	760	3,020
	15-Feb-22	34	<5.0	860	2,980
	5-Nov-21	35	<5.0	780	2,990
	10-Aug-21	34	<5.0	810	2,990
	10-May-21	33	<5.0	770	2,980
	16-Feb-21	34	<5.0	790	3,020
	12-Nov-20	35	<5.0	770	2,870
	14-Aug-20	34	<5.0	800	3,040
	13-May-20	34	<5.0	810	3,070
	10-Feb-20	33	<5.0	810	2,980
	12-Nov-19	33	<5.0	780	2,930
	6-Aug-19	35	<2.0	830	2,980
	16-May-19	36	<5.0	840	2,960
	26-Feb-19	32	<5.0	780	3,030
	14-Nov-18	31	<5.0	880	2,950
	15-Aug-18	34	<5.0	800	3,140
	21-May-18	33	<5.0	790	2,960
	13-Feb-18	29	<5.0	850	3,060
	9-Nov-17	30.7	<0.0500	770	2,680
	14-Aug-17	33.4	0.675	824	3,220
	19-May-17	31.3	<0.0501	791	3,070
	20-Feb-17	31.0	<0.0501	808	3,120
	22-Nov-16	31.3	1.82	831	3,150
	18-Aug-16	35.0	<0.937	849	3,270
	23-May-16	35.9	<2.24	801	3,250
	16-Feb-16	37.7	<1.18	837	3,180
	12-Nov-15	36.1	8.40	811	3,210
	19-Aug-15	35.7	<1.18	761	3,320
	12-May-15	36.3	3.50	791	3,810
	10-Feb-15	37.6	<1.80	770	3,200
	17-Nov-14	37.4	<1.80	793	3,180
	20-Aug-14	35.8	<1.80	766	3,160
	14-May-14	37.0	<1.80	781	3,220
	19-Feb-14	36.9	<1.66	793	3,160
	14-Nov-13	36.1	4.90	837	3,200
	9-Aug-13	20.9	29.4	815	2,890
	9-May-13	37.4	<1.66	790	3,260
	13-Feb-13	38.1	<1.72	841	3,160
	7-Nov-12	36.2	<1.72	820	3,300
	7-Aug-12	36.3	3.78	826	3,260
	25-Apr-12	37.9	<1.72	749	2,260
2-Feb-12	37.5	<2.17	829	3,160	
7-Nov-11	37.7	<2.17	828	2,790	
4-Aug-11	36.8	5.04	798	3,160	
22-Apr-11	38.1	8.40	836	3,220	
27-Jan-11	44.2	6.02	863	3,390	
22-Sep-10	32.2	<10.0	829	3,070	
30-Jun-10	46	< 1.0	860	3,170	
25-Mar-10	19.6	ND	930	3,076	
15-Dec-09	18.3	ND	960	3,012	
1-Sep-09	21.4	ND	970	3,148	
2-Jun-09	17.8	ND	920	3,084	
4-Mar-09	35.8	ND	940	3,104	

**TABLE 5. DISCHARGE PLAN MONITORING WELL GROUNDWATER ANALYTICAL RESULTS
DONA ANA DAIRIES, DONA ANA COUNTY, NEW MEXICO**

Monitoring Well	Date Sampled	Nitrate as N (mg/l)	TKN (mg/l)	Chloride (mg/l)	TDS (mg/l)
70-04	9-Nov-23	17	<0.50	690	3,080
	9-Aug-23	19	<2.0	580	3,040
	8-May-23	22	<5.0	700	3,020
	9-Feb-23	33	<5.0	730	3,090
	8-Nov-22	35	<5.0	660	3,000
	9-Aug-22	25	<5.0	540	3,020
	9-May-22	24	<5.0	550	3,220
	15-Feb-22	17	<2.0	600	3,000
	5-Nov-21	19	<2.0	600	3,030
	10-Aug-21	14	<2.0	610	2,990
	10-May-21	12	<2.0	560	3,010
	16-Feb-21	22	<5.0	600	2,940
	12-Nov-20	35	<5.0	630	2,940
	14-Aug-20	21	<5.0	600	2,900
	13-May-20	20	<2.0	610	2,750
	10-Feb-20	37	<5.0	670	3,190
	12-Nov-19	42	<5.0	640	3,020
	6-Aug-19	38	<2.0	640	2,940
	16-May-19	27	<5.0	680	3,020
	26-Feb-19	25	<5.0	720	3,020
	14-Nov-18	29	<5.0	780	2,980
	15-Aug-18	27	<5.0	680	3,070
	21-May-18	27	<5.0	720	3,150
	13-Feb-18	27	<5.0	710	2,860
	9-Nov-17	26.5	<0.0500	651	2,740
	14-Aug-17	24.6	0.380	655	2,820
	19-May-17	23.9	<0.0501	618	2,680
	20-Feb-17	26.1	<0.0501	644	2,970
	22-Nov-16	26.5	<0.300	625	2,900
	18-Aug-16	27.8	<0.937	739	2,920
	23-May-16	27.3	<2.24	423	2,780
	16-Feb-16	31.4	<1.18	626	2,670
12-Nov-15	28.9	5.60	604	2,700	
19-Aug-15	29.4	<1.18	561	2,820	
12-May-15	27.5	1.40	579	2,860	
10-Feb-15	27.0	<1.80	561	2,580	
17-Nov-14	20.2	<1.80	375	2,720	
20-Aug-14	24.4	<1.80	577	2,950	
15-May-14	24.6	<1.80	610	2,630	
19-Feb-14	22.3	<1.66	607	2,580	
14-Nov-13	21.0	2.80	649	2,630	
9-Aug-13	21.7	4.20	636	2,780	
9-May-13	23.0	<1.66	630	3,510	
11-Jan-13	19.5	<1.72	613	6,200	
Buena Vista Dairy I					
86-01	26-Jan-11	95.4	16.0	2,300	6,240
	20-Sep-10	86.9	<10.0	2,330	6,500
	29-Jun-10	67	<1.0	1,800	5,010
	25-Mar-10	27.0	0.28	1,770	4,814
	15-Dec-09	29.8	ND	1,750	4,670
	1-Sep-09	26.1	ND	1,510	4,474
	2-Jun-09	46.5	4.76	1,590	4,464
	4-Mar-09	42	ND	1,659	4,850
86-02	26-Jan-11	23.4	2.24	641	3,110
	20-Sep-10	24.1	<10.0	613	2,980
	29-Jun-10	21	1.1	660	3,020
	25-Mar-10	16.2	0.7	740	2,740
	15-Dec-09	10.7	0.28	730	2,818
	1-Sep-09	7.2	ND	710	2,824
	2-Jun-09	2.95	ND	700	2,802
	4-Mar-09	16.4	ND	625	2,666

**TABLE 5. DISCHARGE PLAN MONITORING WELL GROUNDWATER ANALYTICAL RESULTS
DONA ANA DAIRIES, DONA ANA COUNTY, NEW MEXICO**

Monitoring Well	Date Sampled	Nitrate as N (mg/l)	TKN (mg/l)	Chloride (mg/l)	TDS (mg/l)
Bright Star Dairy					
340-01	8-Nov-23	67	<2.5	630	2,740
	8-Aug-23	65	<5.0	610	2,870
	5-May-23	62	<1.0	610	2,870
	8-Feb-23	61	<5.0	600	2,840
	8-Nov-22	60	<5.0	680	2,940
	27-Oct-22	58	<5.0	560	2,970
	5-May-22	47	<5.0	610	2,990
	14-Feb-22	48	<5.0	630	2,950
	4-Nov-21	46	<5.0	610	2,980
	9-Aug-21	46	<5.0	580	2,940
	6-May-21	41	<5.0	580	2,900
	15-Feb-21	42	<5.0	570	2,930
	11-Nov-20	41	<5.0	560	2,940
	13-Aug-20	42	<2.0	550	2,950
	14-May-20	42	<5.0	590	2,950
	7-Feb-20	46	<5.0	560	2,850
	12-Nov-19	46	<5.0	560	2,920
	6-Aug-19	48	<2.0	590	2,830
	14-May-19	49	<5.0	610	2,990
	25-Feb-19	50	<5.0	630	3,020
	15-Nov-18	49	<5.0	540	2,880
	14-Aug-18	45	<5.0	560	2,830
	21-May-18	44	<5.0	560	2,700
	12-Feb-18	44	<5.0	640	2,870
	8-Nov-17	46.5	<0.300	576	2,920
	11-Aug-17	46.5	<0.0500	417	2,830
	18-May-17	40.7	<0.0501	579	2,890
	16-Feb-17	40.3	6.48	591	2,820
	10-Nov-16	38.2	1.14	584	2,820
	23-Aug-16	35.3	<0.937	618	3,050
	18-May-16	32.6	<2.24	594	2,980
	11-Feb-16	34.0	<1.18	621	3,080
	9-Nov-15	29.8	<1.18	578	2,820
	20-Aug-15	34.9	<1.18	486	3,080
	11-May-15	41.8	<1.18	437	3,680
	19-Feb-15	50.0	<1.80	339	2,780
	12-Nov-14	49.9	<1.80	337	2,630
	15-Aug-14	37.9	<1.80	383	2,800
	14-May-14	27.4	<1.80	608	2,770
	20-Feb-14	29.1	2.80	564	2,800
11-Nov-13	29.2	3.50	600	2,800	
8-Aug-13	28.6	4.90	694	2,000	
9-May-13	31.1	<1.66	577	3,700	
13-Feb-13	27.0	<1.72	711	3,340	
5-Nov-12	23.8	<1.72	855	3,180	
6-Aug-12	22.7	<1.72	694	3,380	
25-Apr-12	26.3	61.0	681	2,540	
2-Feb-12	27.4	<2.17	661	2,780	
4-Nov-11	26.6	4.34	691	2,910	
25-Jul-11	28.3	4.20	747	2,830	
27-Jan-11	31.1	3.50	578	2,840	
21-Sep-10	24.8	<10.0	513	3,070	
29-Jun-10	29	<0.10	610	2,810	
24-Mar-10	18.8	ND	580	2,508	
15-Dec-09	13.1	ND	650	2,608	
1-Sep-09	12.20	ND	530	2,522	
2-Jun-09	8.67	ND	590	2,434	
4-Mar-09	28.3	ND	530	2,516	

**TABLE 5. DISCHARGE PLAN MONITORING WELL GROUNDWATER ANALYTICAL RESULTS
DONA ANA DAIRIES, DONA ANA COUNTY, NEW MEXICO**

Monitoring Well	Date Sampled	Nitrate as N (mg/l)	TKN (mg/l)	Chloride (mg/l)	TDS (mg/l)	
340-02	8-Nov-23	Dry				
	8-Aug-23	Dry				
	5-May-23	Dry				
	8-Feb-23	Dry				
	8-Nov-22	Dry				
	9-Aug-22	58	<5.0	670	3,090	
	5-May-22	48	<5.0	630	3,040	
	14-Feb-22	55	<5.0	850	3,200	
	4-Nov-21	63	<5.0	810	3,170	
	9-Aug-21	66	<5.0	760	3,240	
	6-May-21	65	<5.0	760	3,440	
	15-Feb-21	75	<5.0	820	3,290	
	11-Nov-20	70	<5.0	810	3,190	
	14-Aug-20	72	<5.0	790	3,240	
	14-May-20	66	<5.0	780	3,170	
	7-Feb-20	75	<5.0	760	3,280	
	12-Nov-19	68	<5.0	750	3,230	
	6-Aug-19	68	<1.0	720	2,990	
	14-May-19	66	<5.0	770	3,050	
	25-Feb-19	67	<5.0	770	3,080	
	15-Nov-18	69	<5.0	750	3,060	
	14-Sep-18	78	<5.0	730	3,200	
	21-May-18	74	<5.0	710	3,220	
	12-Feb-18	84	<5.0	770	3,220	
	8-Nov-17	89.7	<0.300	820	3,010	
	11-Aug-17	92.4	<0.0500	858	3,260	
	18-May-17	101	<0.0501	896	3,260	
	16-Feb-17	101	<0.0501	875	3,350	
	10-Nov-16	93.8	<0.937	878	3,280	
	23-Aug-16	114	<0.937	1,140	3,270	
	18-May-16	Insufficient Water to Sample				
	11-Feb-16	99.1	<1.18	899	3,240	
	9-Nov-15	89.2	<1.18	870	3,200	
	20-Aug-15	83.0	<1.18	782	3,210	
	11-May-15	83.6	<1.18	802	3,100	
	9-Feb-15	91.2	<1.80	809	3,340	
	12-Nov-14	90.1	<1.80	807	3,320	
	15-Aug-14	84.4	<1.80	772	3,420	
	14-May-14	84.6	<1.80	793	3,130	
	20-Feb-14	86.8	<1.66	806	3,080	
	11-Nov-13	87.0	3.50	807	3,160	
8-Aug-13	80.2	4.90	794	3,180		
9-May-13	74.6	<1.66	744	3,180		
13-Feb-13	81.6	<1.72	805	3,550		
5-Nov-12	73.8	4.90	923	3,220		
6-Aug-12	74.0	<1.72	749	3,380		
25-Apr-12	69.8	6.16	727	2,890		
4-Nov-11	75.0	5.74	755	3,620		
22-Jul-11	84.8	7.98	777	2,970		
27-Jan-11	94.1	2.24	760	3,500		
21-Sep-10	92.2	<10.0	778	3,260		
29-Jun-10	87	<0.10	850	3,180		
24-Mar-10	95	ND	930	3,070		
15-Dec-09	82	ND	910	3,072		
1-Sep-09	94	ND	890	3,072		
2-Jun-09	43.2	ND	880	2,954		
4-Mar-09	41.5	ND	885	3,098		

**TABLE 5. DISCHARGE PLAN MONITORING WELL GROUNDWATER ANALYTICAL RESULTS
DONA ANA DAIRIES, DONA ANA COUNTY, NEW MEXICO**

Monitoring Well	Date Sampled	Nitrate as N (mg/l)	TKN (mg/l)	Chloride (mg/l)	TDS (mg/l)
Former D&J Dairy (Dominguez 2)					
42-02	16-Nov-23	7.4	0.71	500	2,570
	14-Aug-23	8.1	<1.0	490	2,450
	10-May-23	8.8	<1.0	610	2,710
	13-Feb-23	9.2	<1.0	550	2,830
	10-Nov-22	9.1	1.3	490	2,660
	11-Aug-22	9.4	<1.0	470	2,620
	11-May-22	10	<2.0	530	2,740
	16-Feb-22	7.3	<1.0	520	2,850
	9-Nov-21	6.6	<1.0	560	2,710
	11-Aug-21	11	<2.0	520	2,660
	11-May-21	7.3	<1.0	490	2,720
	18-Feb-21	7.1	<1.0	540	2,860
	16-Nov-20	7.5	1.1	550	2,800
	18-Aug-20	8.5	<1.0	410	2,400
	22-May-20	10	<2.0	460	2,570
	11-Feb-20	10	<2.0	490	2,680
	22-Nov-19	9.1	<1.0	430	2,620
	16-Aug-19	9.3	<1.0	420	2,440
	29-May-19	7.4	<1.0	470	2,750
	6-Mar-19	7.0	<1.0	460	2,750
	4-Dec-18	7.8	<1.0	580	3,090
	22-Aug-18	7.3	1.1	450	2,600
	29-May-18	7.6	<1.0	610	3,050
	21-Feb-18	8.1	1.1	610	2,960
	1-Dec-17	10.2	0.332	590	2,510
	22-Aug-17	14.8	<0.300	514	2,630
	2-Jun-17	11.0	0.939	542	2,730
	6-Mar-17	12.3	<0.300	501	2,650
	28-Nov-16	11.1	<0.300	506	2,760
	31-Aug-16	12.8	<0.937	539	2,700
	1-Jun-16	8.79	<2.24	469	2,580
	23-Feb-16	9.10	4.48	535	2,560
	1-Dec-15	7.55	<1.18	510	2,420
	26-Aug-15	6.38	5.60	492	2,540
	18-May-15	6.92	5.60	482	2,360
	26-Feb-15	7.61	6.30	483	2,580
	18-Nov-14	8.21	<1.80	461	2,400
	26-Aug-14	7.62	<1.80	477	2,350
	21-May-14	10.2	2.10	498	2,460
	26-Feb-14	9.28	<1.66	469	2,180
26-Nov-13	9.62	2.10	490	2,260	
20-Aug-13	14.5	4.90	459	2,360	
14-May-13	12.0	<1.66	432	2,220	
15-Feb-13	17.6	<1.72	457	2,360	
9-Nov-12	8.99	<1.72	412	2,180	
8-Aug-12	7.73	<1.72	400	1,830	
1-May-12	22.5	<1.72	431	2,210	
16-Feb-12	24.5	<2.17	465	2,770	
9-Nov-11	21.2	3.08	449	2,170	
2-Aug-11	20.5	2.38	424	2,360	
25-Apr-11	29.1	<2.17	365	2,140	
28-Jan-11	22.7	6.72	408	2,150	
1-Oct-10	21.0	<10.0	355	2,010	
27-Jun-10	27	<5.0	360	2,220	
6-Mar-10	31.3	<0.3	380	2,145	
16-Jan-10	25.7	0.3	350	2,090	
15-Sep-09	24.6	0.9	350	2,075	
3-Jun-09	30.6	0.6	320	2,045	
14-Mar-09	29.6	0.7	370	2,115	

**TABLE 5. DISCHARGE PLAN MONITORING WELL GROUNDWATER ANALYTICAL RESULTS
DONA ANA DAIRIES, DONA ANA COUNTY, NEW MEXICO**

Monitoring Well	Date Sampled	Nitrate as N (mg/l)	TKN (mg/l)	Chloride (mg/l)	TDS (mg/l)
42-03	16-Nov-23	38	<0.50	980	3,170
	11-Aug-23	36	<5.0	1,000	3,160
	9-May-23	34	<5.0	1,200	3,160
	10-Feb-23	31	<5.0	1,000	3,230
	9-Nov-22	33	<5.0	980	3,230
	10-Aug-22	34	<5.0	1,000	3,290
	10-May-22	33	<5.0	970	3,280
	16-Feb-22	31	<5.0	1,000	3,240
	8-Nov-21	31	<5.0	1,100	3,240
	10-Aug-21	28	<5.0	1,100	3,220
	11-May-21	28	<5.0	1,000	3,230
	17-Feb-21	29	<5.0	1,100	3,210
	16-Nov-20	30	<5.0	1,100	3,340
	18-Aug-20	30	<1.0	1,100	3,340
	20-May-20	28	<5.0	1,100	3,300
	11-Feb-20	26	<5.0	1,200	3,370
	22-Nov-19	29	<1.0	1,000	3,380
	16-Aug-19	34	<1.0	1,200	3,420
	30-May-19	30	<5.0	1,200	3,380
	6-Mar-19	32	<5.0	1,100	3,390
	4-Dec-18	41	<5.0	1,200	3,550
	22-Aug-18	40	<5.0	1,100	3,530
	29-May-18	43	<5.0	1,200	3,590
	21-Feb-18	36	<5.0	1,200	3,570
	1-Dec-17	43.6	<0.300	1,350	3,350
	23-Aug-17	54.5	<0.300	1,010	3,540
	2-Jun-17	57.1	<0.100	1,120	3,630
	6-Mar-17	49.2	<0.300	1,170	3,690
	28-Nov-16	50.2	<0.300	1,180	3,730
	31-Aug-16	93.5	<0.937	983	3,400
	1-Jun-16	90.0	<2.24	956	3,680
	23-Feb-16	68.0	<1.18	1,190	3,740
	1-Dec-15	97.9	<1.18	933	3,380
	26-Aug-15	74.7	<1.18	1,040	3,820
	18-May-15	86.9	2.1	1,010	3,470
	27-Feb-15	68.6	<1.80	1,020	3,630
	18-Nov-14	73.2	16.1	1,040	3,560
	26-Aug-14	78.0	<1.80	891	3,360
	21-May-14	62.6	<1.80	1,100	3,720
	26-Feb-14	62.8	<1.66	1,070	3,160
	26-Nov-13	62.9	2.80	1,090	3,660
	15-Aug-13	67.5	17.5	1,090	3,560
14-May-13	59.6	<1.66	1,150	3,800	
15-Feb-13	60.3	<1.72	1,140	3,800	
9-Nov-12	56.2	<1.72	1,120	3,800	
8-Aug-12	71.1	<1.72	1,370	3,520	
1-May-12	51.5	<1.72	1,030	3,620	
16-Feb-12	51.3	<2.17	1,130	3,760	
9-Nov-11	58.9	2.80	1,000	3,660	
1-Aug-11	59.2	<2.17	1,030	3,720	
25-Apr-11	58.8	<2.17	1,080	3,620	
28-Jan-11	69.5	3.78	1,160	3,690	
1-Oct-10	63.0	<10.0	1,090	3,640	
27-Jun-10	49	<5.0	1,100	3,780	
6-Mar-10	39.6	<0.3	1,180	3,935	
16-Jan-10	43.3	<0.3	1,200	3,800	
15-Sep-09	52.3	0.3	1,130	3,765	
3-Jun-09	48.2	0.3	1,240	3,860	
14-Mar-09	32.2	<0.2	1,240	3,800	

**TABLE 5. DISCHARGE PLAN MONITORING WELL GROUNDWATER ANALYTICAL RESULTS
DONA ANA DAIRIES, DONA ANA COUNTY, NEW MEXICO**

Monitoring Well	Date Sampled	Nitrate as N (mg/l)	TKN (mg/l)	Chloride (mg/l)	TDS (mg/l)
42-06	16-Nov-23	66	<0.50	330	2,090
	11-Aug-23	60	<5.0	330	2,170
	9-May-23	91	<5.0	370	2,530
	10-Feb-23	120	<5.0	390	2,530
	9-Nov-22	82	<5.0	360	2,400
	10-Aug-22	91	<5.0	360	2,520
	10-May-22	170	<1.0	520	3,420
	17-Feb-22	170	<5.0	570	3,510
	8-Nov-21	200	<5.0	650	3,620
	11-Aug-21	200	<5.0	590	3,500
	11-May-21	210	<5.0	630	3,710
	18-Feb-21	230	<5.0	720	3,800
	16-Nov-20	190	<5.0	560	3,260
	18-Aug-20	150	<1.0	480	3,030
	22-May-20	200	<5.0	620	3,480
	12-Feb-20	150	<5.0	470	2,850
	22-Nov-19	180	<1.0	360	2,760
	16-Aug-19	150	<1.0	440	2,740
	30-May-19	140	<5.0	350	2,540
	6-Mar-19	130	<5.0	470	2,810
	4-Dec-18	97	<5.0	560	2,690
	22-Aug-18	140	<5.0	420	2,850
	29-May-18	160	<5.0	610	3,060
	21-Feb-18	140	<5.0	590	2,920
	1-Dec-17	129	<0.300	522	2,350
	22-Aug-17	123	<0.300	295	2,250
	2-Jun-17	98.1	0.615	424	2,340
	6-Mar-17	102	<0.300	280	2,180
	28-Nov-16	66.9	<0.300	291	2,100
	31-Aug-16	67.9	<0.937	275	1,970
	1-Jun-16	87.7	<2.24	300	2,250
	23-Feb-16	60.0	<1.18	308	2,050
	1-Dec-15	84.5	<1.18	358	2,220
	26-Aug-15	80.7	<1.18	391	2,680
	18-May-15	90.6	2.80	373	2,160
	26-Feb-15	78.0	2.80	323	2,100
	18-Nov-14	94.6	<1.80	302	2,160
	13-Aug-14	83.6	<1.80	302	2,220
	21-May-14	87.9	2.80	395	2,440
	26-Feb-14	59.3	<1.66	417	2,380
26-Nov-13	76.3	2.10	397	2,270	
20-Aug-13	95.1	4.90	432	2,580	
14-May-13	86.5	<1.66	413	2,390	
15-Feb-13	82.9	<1.72	457	2,430	
9-Nov-12	75.9	<1.72	478	2,570	
8-Aug-12	81.5	1.82	484	2,475	
1-May-12	87.0	1.96	720	2,920	
16-Feb-12	92.4	<2.17	630	3,100	
9-Nov-11	101	<2.17	617	3,000	
2-Aug-11	88.6	3.22	525	2,980	
25-Apr-11	72.2	<2.17	454	2,500	
28-Jan-11	69.8	4.20	421	2,780	
1-Oct-10	113	<10.0	497	2,660	
27-Jun-10	46	<5.0	400	2,550	
6-Mar-10	43.1	<0.3	480	2,510	
16-Jan-10	44.2	0.3	1,150	2,600	
14-Sep-09	54.8	0.4	450	2,600	
3-Jun-09	0.02	<0.2	1,240	3,780	
14-Mar-09	49.7	0.2	480	2,540	

**TABLE 5. DISCHARGE PLAN MONITORING WELL GROUNDWATER ANALYTICAL RESULTS
DONA ANA DAIRIES, DONA ANA COUNTY, NEW MEXICO**

Monitoring Well	Date Sampled	Nitrate as N (mg/l)	TKN (mg/l)	Chloride (mg/l)	TDS (mg/l)
42-07	10-Nov-20	Plugged and Abandoned			
	18-Aug-20	Dry			
	11-Feb-20	Dry			
	22-Nov-19	Dry			
	16-Aug-19	Dry			
	29-May-19	Dry			
	6-Mar-19	Dry			
	4-Dec-18	Dry			
	23-Aug-18	Dry			
	29-May-18	Dry			
	21-Feb-18	Dry			
	22-Aug-17	Dry			
	2-Jun-17	Dry			
	6-Mar-17	Dry			
	28-Nov-16	Dry			
	31-Aug-16	Dry			
	1-Jun-16	Dry			
	23-Feb-16	Dry			
	1-Dec-15	Dry			
	26-Aug-15	Dry			
	18-May-15	Dry			
	26-Feb-15	Dry			
	18-Nov-14	Dry			
	26-Aug-14	Dry			
	22-May-14	Dry			
	26-Feb-14	Dry			
	26-Nov-13	Dry			
	15-Aug-13	Dry			
	14-May-13	Dry			
	15-Feb-13	Dry			
	9-Nov-12	Dry			
	8-Aug-12	Dry			
	1-May-12	Dry			
16-Feb-12	Dry				
9-Nov-11	57.9	<2.17	1,090	3,450	
2-Aug-11	Dry				
25-Apr-11	68.5	<2.17	1,230	4,080	
28-Jan-11	88.3	4.48	1,130	4,180	
1-Oct-10	92.0	<40.0	1,390	4,260	
27-Jun-10	63	<5.0	1,400	4,330	
6-Mar-10	63.1	<0.3	1,490	4,345	
16-Jan-10	59.6	<0.3	1,480	4,275	
15-Sep-09	66.6	<0.3	1,290	4,195	
3-Jun-09	57.4	<0.2	1,550	4,225	
14-Mar-09	43.7	<0.2	1,500	4,110	

**TABLE 5. DISCHARGE PLAN MONITORING WELL GROUNDWATER ANALYTICAL RESULTS
DONA ANA DAIRIES, DONA ANA COUNTY, NEW MEXICO**

Monitoring Well	Date Sampled	Nitrate as N (mg/l)	TKN (mg/l)	Chloride (mg/l)	TDS (mg/l)	
42-08	16-Nov-23	7.3	0.81	500	2,540	
	14-Aug-23	21	<5.0	270	1,860	
	10-May-23	11	<2.0	530	2,600	
	13-Feb-23	22	<5.0	280	1,860	
	9-Nov-22	16	<2.0	370	2,160	
	10-Aug-22	19	<2.0	310	2,090	
	11-May-22	24	<5.0	260	1,800	
	17-Feb-22	25	<5.0	270	1,830	
	9-Nov-21	32	<5.0	230	1,640	
	11-Aug-21	36	<5.0	220	1,700	
	11-May-21	40	<5.0	180	1,460	
	18-Feb-21	35	<5.0	250	1,730	
	16-Nov-20	42	<5.0	170	1,680	
	18-Aug-20	17	<1.0	370	2,290	
	22-May-20	42	<5.0	240	1,780	
	12-Feb-20	40	<5.0	240	1,830	
	22-Nov-19	35	<1.0	290	2,000	
	16-Aug-19	42	<1.0	290	1,920	
	29-May-19	60	<5.0	130	1,410	
	6-Mar-19	49	<5.0	96	1,310	
	4-Dec-18	36	<5.0	54	1,280	
	22-Aug-18	29	<5.0	200	1,700	
	29-May-18	27	<5.0	93	1,200	
	21-Feb-18	20	<5.0	130	1,290	
	2-Dec-17	24.0	<0.300	135	1,160	
	22-Aug-17	30.6	<0.300	203	1,580	
	2-Jun-17	32.3	1.03	43	1,030	
	6-Mar-17	36.8	<0.300	41	1,200	
	28-Nov-16	37.0	<0.300	43	1,160	
	31-Aug-16	40.6	<0.937	53	1,300	
	1-Jun-16	Dry				
	23-Feb-16	Dry				
	1-Dec-15	Dry				
	26-Aug-15	37.4	<1.18	89.6	1,640	
	18-May-15	Not Sampled - insufficient water to sample				
	26-Feb-15	44.9	<1.80	85.7	1,400	
	18-Nov-14	47.3	<1.80	117	1,440	
	26-Aug-14	36.1	<1.80	159	1,500	
	21-May-14	33.1	<1.80	149	1,470	
	26-Feb-14	32.6	<1.66	251	1,790	
	26-Nov-13	30.8	2.10	275	1,780	
	20-Aug-13	30.3	6.30	292	2,000	
	14-May-13	29.9	<1.66	259	1,880	
	15-Feb-13	31.8	<1.72	284	1,860	
9-Nov-12	30.4	<1.72	283	1,930		
8-Aug-12	36.4	<1.72	307	1,938		
1-May-12	36.0	<1.72	246	1,700		
16-Feb-12	37.0	<2.17	254	1,850		
9-Nov-11	40.0	<2.17	269	1,770		
2-Aug-11	41.3	2.38	253	2,030		
25-Apr-11	51.4	2.66	201	1,970		
28-Jan-11	46.2	5.46	219	2,020		
1-Oct-10	49.0	<10.0	288	2,160		
27-Jun-10	75	<5.0	300	2,220		
6-Mar-10	76.8	<0.3	365	2,290		
16-Jan-10	82.8	<0.3	350	2,315		
15-Sep-09	87.1	0.7	410	2,340		
3-Jun-09	65.8	0.8	380	2,175		
14-Mar-09	43.2	0.4	400	2,220		

**TABLE 5. DISCHARGE PLAN MONITORING WELL GROUNDWATER ANALYTICAL RESULTS
DONA ANA DAIRIES, DONA ANA COUNTY, NEW MEXICO**

Monitoring Well	Date Sampled	Nitrate as N (mg/l)	TKN (mg/l)	Chloride (mg/l)	TDS (mg/l)
42-09	10-Nov-20	Plugged and Abandoned			
	1-Dec-15	Not Sampled - Destroyed			
	26-Aug-15	57.1	<1.18	712	3,020
	18-May-15	58.0	<1.18	733	3,050
	26-Feb-15	69.8	<1.80	673	2,960
	18-Nov-14	46.4	<1.80	722	3,000
	26-Aug-14	46.5	<1.80	674	3,000
	22-May-14	59.3	<1.80	699	3,060
	26-Feb-14	53.5	<1.66	715	3,030
	26-Nov-13	51.2	2.80	731	3,030
	15-Aug-13	56.1	37.8	725	3,010
	14-May-13	51.6	<1.66	717	3,200
	15-Feb-13	47.0	<1.72	653	2,870
	9-Nov-12	48.4	<1.72	641	3,030
	8-Aug-12	49.5	<1.72	597	2,475
	1-May-12	50.3	<1.72	542	2,820
	16-Feb-12	50.7	<2.17	627	2,920
	9-Nov-11	47.8	<2.17	591	1,810
	1-Aug-11	55.0	<2.17	579	2,750
	25-Apr-11	65.8	<2.17	664	2,820
	28-Jan-11	44.9	<2.17	537	2,940
	28-Sep-10	38.0	<10.0	591	2,760
	27-Jun-10	68	<5.0	610	3,010
	6-Mar-10	Not Sampled			
	16-Jan-10	52.8	<0.3	690	2,970
	15-Sep-09	68.8	0.7	650	3,000
	3-Jun-09	66.5	0.7	690	3,000
14-Mar-09	59.5	0.4	700	3,050	

**TABLE 5. DISCHARGE PLAN MONITORING WELL GROUNDWATER ANALYTICAL RESULTS
DONA ANA DAIRIES, DONA ANA COUNTY, NEW MEXICO**

Monitoring Well	Date Sampled	Nitrate as N (mg/l)	TKN (mg/l)	Chloride (mg/l)	TDS (mg/l)
42-10	15-Nov-23	Not Sampled - insufficient water to sample			
	16-Aug-23	7.6	<1.0	430	1,510
	11-May-23	7.9	<1.0	410	1,610
	14-Feb-23	6.3	<1.0	420	1,610
	10-Nov-22	7.4	<1.0	410	1,630
	11-Aug-22	6.7	<1.0	400	1,470
	11-May-22	6.4	<1.0	420	1,610
	15-Feb-22	6.1	<1.0	410	1,590
	9-Nov-21	4.5	<1.0	410	1,540
	12-Aug-21	3.8	<1.0	400	1,520
	12-May-21	3.0	<1.0	370	1,490
	17-Feb-21	2.1	<1.0	400	1,470
	13-Nov-20	1.4	<1.0	380	1,460
	19-Aug-20	<1.0	<1.0	380	1,440
	22-May-20	1.3	3.8	390	1,540
	12-Feb-20	1.2	<1.0	370	1,490
	25-Nov-19	0.84	<1.0	370	1,550
	19-Aug-19	<1.0	<1.0	400	1,540
	30-May-19	<1.0	<1.0	390	1,470
	6-Mar-19	<1.0	<1.0	370	1,410
	4-Dec-18	<1.0	<1.0	410	1,410
	22-Aug-18	<1.0	<1.0	370	1,390
	30-May-18	0.21	<1.0	380	1,360
	19-Feb-18	<1.0	<1.0	400	1,390
	4-Dec-17	0.592	<0.300	380	1,300
	23-Aug-17	0.469	<0.300	396	1,350
	2-Jun-17	0.429	1.23	405	1,300
	6-Mar-17	0.542	<0.300	403	1,270
	29-Nov-16	1.45	<0.300	425	1,380
	1-Sep-16	<0.305	<0.937	414	1,370
	1-Jun-16	0.354	<2.24	425	1,520
	23-Feb-16	<0.0610	<1.18	459	1,460
	1-Dec-15	0.165	<1.18	439	1,300
	25-Aug-15	<0.194	<1.18	436	1,440
	18-May-15	1.07	<1.18	471	1,360
	27-Feb-15	0.947	<1.80	439	1,520
	19-Nov-14	1.08	11.9	441	1,340
	26-Aug-14	1.08	<1.80	410	1,340
	22-May-14	1.25	<1.80	457	1,420
	26-Feb-14	0.982	<1.66	416	1,400
	26-Nov-13	1.10	2.10	435	1,420
	20-Aug-13	0.991	9.10	423	1,540
14-May-13	0.976	<1.66	395	1,400	
15-Feb-13	<0.246	<1.72	415	1,380	
9-Nov-12	<0.0290	<1.72	397	1,350	
8-Aug-12	0.186	<1.72	403	1,328	
1-May-12	0.236	<1.72	363	1,260	
16-Feb-12	<0.500	<2.17	419	1,440	
8-Nov-11	<0.500	<2.17	425	1,510	
2-Aug-11	<0.500	<2.17	469	1,540	
25-Apr-11	<0.500	<2.17	453	1,500	
28-Jan-11	2.15	<2.17	345	1,280	
1-Oct-10	0.220	<10.0	360	1,450	
27-Jun-10	<0.50	<1.0	420	1,490	
6-Mar-10	0.23	<0.3	440	1,500	
16-Jan-10	<0.03	<0.3	430	1,435	
15-Sep-09	0.16	<0.3	400	1,425	
3-Jun-09	0.21	<0.2	450	1,535	
14-Mar-09	0.02	<0.2	480	1,480	

**TABLE 5. DISCHARGE PLAN MONITORING WELL GROUNDWATER ANALYTICAL RESULTS
DONA ANA DAIRIES, DONA ANA COUNTY, NEW MEXICO**

Monitoring Well	Date Sampled	Nitrate as N (mg/l)	TKN (mg/l)	Chloride (mg/l)	TDS (mg/l)
42-11	15-Nov-23	<1.0	<0.50	310	1,120
	14-Aug-23	<1.0	<1.0	350	1,310
	10-May-23	<1.0	<1.0	440	1,420
	14-Feb-23	<1.0	<1.0	350	1,370
	10-Nov-22	<1.0	<1.0	360	1,380
	11-Aug-22	<1.0	<1.0	340	1,390
	11-May-22	<1.0	<1.0	350	1,390
	17-Feb-22	<1.0	<1.0	380	1,410
	9-Nov-21	<1.0	<1.0	390	1,400
	12-Aug-21	<1.0	<1.0	360	1,350
	12-May-21	<1.0	<1.0	350	1,390
	17-Feb-21	<1.0	<1.0	360	1,350
	13-Nov-20	<1.0	<1.0	330	1,310
	19-Aug-20	<1.0	<1.0	300	1,250
	22-May-20	1.1	<1.0	310	1,200
	12-Feb-20	1.3	<1.0	290	1,220
	25-Nov-19	1.4	<1.0	310	1,200
	19-Aug-19	1.2	<1.0	280	1,200
	30-May-19	1.3	<1.0	280	1,180
	6-Mar-19	1.3	<1.0	260	1,160
	4-Dec-18	1.3	<1.0	290	1,160
	22-Aug-18	1.4	<1.0	270	1,190
	30-May-18	1.4	<1.0	330	1,160
	19-Feb-18	1.4	<1.0	310	1,200
	4-Dec-17	1.66	<0.300	268	1,040
	23-Aug-17	1.72	<0.300	291	1,100
	2-Jun-17	1.38	0.591	293	1,090
	3-Mar-17	1.66	<0.300	298	1,140
	29-Nov-16	2.39	<0.300	301	1,120
	1-Sep-16	1.23	<0.937	305	1,180
	1-Jun-16	1.34	<2.24	302	1,190
	23-Feb-16	1.23	<1.18	319	1,190
	1-Dec-15	1.16	<1.18	303	1,160
	25-Aug-15	1.00	<1.18	302	1,160
	18-May-15	1.79	<1.18	308	1,100
	27-Feb-15	1.66	<1.80	300	1,160
	19-Nov-14	1.83	2.10	316	1,170
	27-Aug-14	1.78	6.30	295	1,200
	22-May-14	1.87	<1.80	312	1,120
	26-Feb-14	1.44	<1.66	339	1,280
	26-Nov-13	1.43	2.80	344	1,260
	20-Aug-13	1.50	2.80	334	1,280
14-May-13	1.78	<1.66	303	1,220	
15-Feb-13	1.64	<1.72	327	1,210	
9-Nov-12	<0.0290	<1.72	315	1,230	
8-Aug-12	1.21	<1.72	308	1,182	
1-May-12	1.24	<1.72	274	1,160	
16-Feb-12	<0.500	<2.17	337	1,240	
8-Nov-11	1.97	<2.17	334	1,480	
2-Aug-11	3.07	<2.17	308	1,160	
25-Apr-11	3.45	<2.17	304	795	
28-Jan-11	0.47	2.38	285	1,300	
1-Oct-10	0.62	<10.0	300	1,250	
27-Jun-10	3.90	<1.0	290	1,080	
6-Mar-10	0.51	<0.3	370	1,300	
16-Jan-10	0.03	<0.3	370	1,325	
15-Sep-09	0.41	<0.3	320	1,245	
3-Jun-09	3.00	0.70	300	1,080	
14-Mar-09	0.90	<0.2	310	1,225	

**TABLE 5. DISCHARGE PLAN MONITORING WELL GROUNDWATER ANALYTICAL RESULTS
DONA ANA DAIRIES, DONA ANA COUNTY, NEW MEXICO**

Monitoring Well	Date Sampled	Nitrate as N (mg/l)	TKN (mg/l)	Chloride (mg/l)	TDS (mg/l)
42-12	15-Nov-23	Not Sampled - insufficient water to sample			
	16-Aug-23	<1.0	<1.0	270	1,030
	11-May-23	<1.0	<1.0	250	1,010
	14-Feb-23	1.8	<1.0	260	1,080
	10-Nov-22	<1.0	<1.0	270	1,090
	11-Aug-22	1.0	<1.0	260	1,070
	11-May-22	1.6	<1.0	250	1,080
	17-Feb-22	1.9	<1.0	270	1,090
	9-Nov-21	1.8	<1.0	270	1,080
	12-Aug-21	1.6	<1.0	290	1,110
	12-May-21	1.7	<1.0	270	1,120
	17-Feb-21	1.7	<1.0	290	1,090
	13-Nov-20	1.3	<1.0	310	1,100
	19-Aug-20	<1.0	<1.0	310	1,130
	22-May-20	1.1	<1.0	310	1,130
	12-Feb-20	1.3	<1.0	330	1,160
	25-Nov-19	1.1	<1.0	350	1,170
	19-Aug-19	<1.0	<1.0	330	1,170
	30-May-19	1.0	<1.0	320	1,180
	6-Mar-19	<1.0	<1.0	300	1,190
	4-Dec-18	<1.0	<1.0	330	1,190
	22-Aug-18	1.0	<1.0	330	1,190
	30-May-18	0.78	<1.0	370	1,200
	19-Feb-18	<1.0	<1.0	330	1,240
	4-Dec-17	0.825	0.460	321	1,030
	23-Aug-17	0.684	<0.300	325	1,170
	2-Jun-17	0.913	0.236	328	1,170
	6-Mar-17	1.07	<0.300	330	1,210
	29-Nov-16	1.84	<0.300	346	1,200
	1-Sep-16	0.731	<0.937	344	1,210
	1-Jun-16	0.949	<2.24	341	1,250
	23-Feb-16	0.789	<1.18	352	1,140
	1-Dec-15	0.917	<1.18	341	1,140
	25-Aug-15	0.774	<1.18	340	1,110
	18-May-15	1.78	<1.18	350	1,120
	27-Feb-15	1.87	<1.80	327	1,200
	19-Nov-14	2.10	<1.80	333	1,220
	26-Aug-14	1.96	48.3	319	1,290
	22-May-14	2.18	<1.80	337	1,160
	26-Feb-14	1.87	<1.66	336	1,180
	26-Nov-13	1.95	2.10	341	1,160
	20-Aug-13	1.77	3.50	337	1,200
14-May-13	1.73	<1.66	319	1,170	
15-Feb-13	1.72	<1.72	332	1,170	
9-Nov-12	<0.0290	<1.72	315	1,170	
8-Aug-12	1.15	2.66	333	1,134	
1-May-12	0.750	<1.72	282	1,180	
16-Feb-12	<0.500	<2.17	341	1,200	
8-Nov-11	<0.500	<2.17	331	730	
2-Aug-11	<0.100	<2.17	331	1,340	
25-Apr-11	<0.500	<2.17	339	1,280	
28-Jan-11	0.580	<2.17	276	970	
1-Oct-10	4.50	<10.0	312	1,280	
27-Jun-10	0.72	<1.0	320	1,270	
6-Mar-10	0.13	<0.3	350	1,230	
16-Jan-10	0.42	<0.3	340	1,250	
15-Sep-09	0.65	<0.3	310	1,215	
3-Jun-09	0.82	<0.2	330	1,280	
14-Mar-09	0.70	<0.2	340	1,240	

**TABLE 5. DISCHARGE PLAN MONITORING WELL GROUNDWATER ANALYTICAL RESULTS
DONA ANA DAIRIES, DONA ANA COUNTY, NEW MEXICO**

Monitoring Well	Date Sampled	Nitrate as N (mg/l)	TKN (mg/l)	Chloride (mg/l)	TDS (mg/l)	
42-13	16-Nov-23	38	<0.50	990	3,150	
	11-Aug-23	36	<5.0	1,000	3,230	
	9-May-23	11	<2.0	900	3,060	
	10-Feb-23	15	<2.0	1,000	3,250	
	9-Nov-22	16	<2.0	980	3,270	
	10-Aug-22	16	<2.0	950	3,290	
	10-May-22	21	<5.0	940	3,380	
	16-Feb-22	16	<2.0	1,000	3,330	
	8-Nov-21	16	<2.0	1,000	3,310	
	11-Aug-21	20	<5.0	1,000	3,330	
	11-May-21	20	<2.0	1,000	3,340	
	17-Feb-21	39	<5.0	1,100	3,510	
	16-Nov-20	48	<5.0	1,100	3,670	
	18-Aug-20	69	<1.0	1,000	3,710	
	22-May-20	42	<5.0	950	3,390	
	11-Feb-20	41	<5.0	990	3,520	
	22-Nov-19	33	<1.0	1,000	3,570	
	16-Aug-19	Not Sampled - Water level below pump				
	29-May-19	Not Sampled - Water level below pump				
	6-Mar-19	54	<5.0	910	3,510	
	4-Dec-18	Not Sampled - Water level below pump				
	22-Aug-18	43	<5.0	1,000	3,470	
	29-May-18	61	<5.0	970	3,590	
	21-Feb-18	57	<5.0	1,000	3,540	
	1-Dec-17	48.0	<0.300	1,090	3,240	
	23-Aug-17	Pump Not Operational				
	2-Jun-17	Pump Not Operational				
	6-Mar-17	43.6	0.374	838	3,410	
	28-Nov-16	43.5	<0.300	839	3,340	
	31-Aug-16	Not Sampled - Water level below pump				
	1-Jun-16	Not Sampled - Water level below pump				
	23-Feb-16	Not Sampled - Water level below pump				
	1-Dec-15	Not Sampled - Water level below pump				
	26-Aug-15	49.3	<1.18	756	3,480	
	18-May-15	50.6	<1.18	830	3,340	
	26-Feb-15	49.0	<1.80	781	3,420	
	18-Nov-14	54.6	<1.80	855	3,360	
	27-Aug-14	77.9	2.10	927	3,490	
	22-May-14	50.9	<1.80	873	3,560	
	26-Feb-14	50.0	<1.66	871	3,340	
	26-Nov-13	49.8	3.50	895	3,260	
	15-Aug-13	59.9	3.50	891	3,380	
	14-May-13	49.7	<1.66	809	3,320	
	15-Feb-13	54.3	<1.72	855	3,430	
	9-Nov-12	52.2	<1.72	835	3,250	
	8-Aug-12	62.3	<1.72	871	3,110	
	1-May-12	81.5	<1.72	902	3,550	
16-Feb-12	99.1	<2.17	1,020	3,880		
9-Nov-11	61.5	<2.17	901	3,160		
2-Aug-11	106	<2.17	1,900	3,280		
25-Apr-11	55.9	<2.17	1,000	3,600		
28-Jan-11	52.6	<2.17	868	3,720		
29-Sep-10	44.5	<10.0	833	3,360		
27-Jun-10	48	<5.0	1,000	3,810		
6-Mar-10	Not Sampled					
16-Jan-10	46.3	<0.3	1,130	3,810		
15-Sep-09	54.8	0.5	1,100	3,940		
3-Jun-09	51.6	<0.2	1,110	3,775		
14-Mar-09	51.0	0.6	1,040	3,735		

**TABLE 5. DISCHARGE PLAN MONITORING WELL GROUNDWATER ANALYTICAL RESULTS
DONA ANA DAIRIES, DONA ANA COUNTY, NEW MEXICO**

Monitoring Well	Date Sampled	Nitrate as N (mg/l)	TKN (mg/l)	Chloride (mg/l)	TDS (mg/l)
Dominguez					
624-01	10-Nov-23	17	<0.50	920	2,720
	17-Aug-23	18	<2.0	880	2,750
	12-May-23	12	<2.0	850	2,680
	16-Feb-23	13	<2.0	860	2,770
	11-Nov-22	12	<2.0	840	2,880
	12-Aug-22	12	<2.0	920	2,820
	12-May-22	19	<2.0	750	2,550
	18-Feb-22	6.1	<1.0	670	2,340
	10-Nov-21	4.5	<1.0	650	2,220
	27-Aug-21	10	<2.0	700	2,400
	14-May-21	6.7	<1.0	560	1,960
	18-Feb-21	3.1	2.5	540	1,950
	13-Nov-20	4.3	<1.0	540	1,990
	17-Aug-20	3.7	<1.0	500	1,910
	15-May-20	6.6	<1.0	520	1,980
	12-Feb-20	8.7	<1.0	510	2,050
	15-Nov-19	13	<2.0	550	2,190
	13-Aug-19	9.2	<1.0	660	2,390
	20-May-19	12	<2.0	910	2,860
	28-Feb-19	11	<2.0	1,000	3,170
	20-Nov-18	16	<5.0	630	2,180
	29-Aug-18	9.9	<1.0	990	3,700
	22-May-18	13	<2.0	1,000	3,240
	14-Feb-18	13	<2.0	940	3,110
	14-Nov-17	12.7	<0.300	979	2,750
	15-Aug-17	14.8	<0.300	1,050	3,080
	23-May-17	14.6	<0.300	1,060	3,030
	22-Feb-17	15.3	<0.0501	997	3,210
	14-Nov-16	11.3	<0.937	1,040	3,260
	19-Aug-16	7.25	<0.937	926	2,970
	19-May-16	20.6	<2.24	808	2,710
	16-Feb-16	11.0	1.68	744	2,480
	10-Nov-15	7.06	3.36	703	2,440
	7-Aug-15	14.0	<1.18	1,010	3,110
	19-May-15	16.7	1.40	750	3,070
	12-Feb-15	9.54	2.10	798	2,880
	17-Nov-14	11.2	<1.80	790	2,620
	19-Aug-14	11.8	<1.80	794	2,590
	20-May-14	23.2	4.90	1,050	3,320
	25-Feb-14	18.6	<1.66	950	3,080
19-Nov-13	23.6	2.10	1,080	3,250	
14-Aug-13	15.4	3.50	970	2,990	
13-May-13	20.8	<1.66	894	2,720	
14-Feb-13	15.6	<1.72	827	2,980	
12-Nov-12	12.2	<1.72	652	2,590	
9-Aug-12	17.4	2.80	1,080	3,550	
30-Apr-12	8.69	36.4	1,400	4,180	
7-Feb-12	10.0	9.52	1,420	3,180	
4-Nov-11	10.8	5.60	1,430	3,460	
3-Aug-11	10.7	<2.17	1,580	3,970	
27-Apr-11	<0.500	30.8	1,330	4,040	
25-Jan-11	14.0	<2.17	1,280	3,760	
21-Sep-10	8.20	<10.0	1,260	3,780	
27-Jun-10	11	<2.0	1,600	4,520	
6-Mar-10	17.2	<0.3	910	2,610	
16-Jan-10	5.5	0.4	840	2,540	
15-Sep-09	6.5	0.6	760	2,455	
3-Jun-09	16.1	0.7	810	2,790	
14-Mar-09	21.9	0.3	1,190	3,305	

**TABLE 5. DISCHARGE PLAN MONITORING WELL GROUNDWATER ANALYTICAL RESULTS
DONA ANA DAIRIES, DONA ANA COUNTY, NEW MEXICO**

Monitoring Well	Date Sampled	Nitrate as N (mg/l)	TKN (mg/l)	Chloride (mg/l)	TDS (mg/l)
624-02	10-Nov-23	8.2	<0.50	660	2,590
	17-Aug-23	9.8	<1.0	750	3,010
	12-May-23	9.3	<1.0	690	2,680
	16-Feb-23	9.2	<1.0	640	2,720
	11-Nov-22	8.7	<1.0	600	2,740
	12-Aug-22	13	<2.0	850	3,240
	12-May-22	13	<2.0	800	3,430
	18-Feb-22	12	<2.0	830	3,240
	11-Nov-21	7.2	<1.0	680	2,840
	27-Aug-21	4.1	<1.0	480	2,160
	14-May-21	5.6	<1.0	740	2,710
	19-Feb-21	3.6	<1.0	650	2,320
	12-Nov-20	5.2	<1.0	480	2,300
	17-Aug-20	5.4	<1.0	610	2,350
	15-May-20	4.3	<1.0	550	2,300
	12-Feb-20	4.4	<1.0	480	2,210
	15-Nov-19	5.2	<1.0	530	2,470
	13-Aug-19	7.7	<1.0	790	2,860
	20-May-19	7.4	<1.0	770	2,860
	28-Feb-19	8.2	<1.0	950	3,130
	20-Nov-18	9.4	<2.0	850	3,010
	29-Aug-18	8.9	<1.0	710	2,160
	22-May-18	10	<2.0	860	3,290
	14-Feb-18	9.1	<1.0	720	2,920
	14-Nov-17	8.97	0.364	706	2,780
	15-Aug-17	10.9	2.00	796	3,020
	23-May-17	14.2	<0.300	827	3,590
	22-Feb-17	11.7	<0.0501	793	3,060
	14-Nov-16	8.58	<0.937	747	2,850
	19-Aug-16	6.46	<0.937	692	2,590
	19-May-16	18.5	< 2.24	914	3,280
	16-Feb-16	10.2	<1.18	785	2,800
	10-Nov-15	17.2	<1.18	1,050	3,290
	7-Aug-15	15.6	<1.18	801	2,710
	19-May-15	17.3	<1.18	859	3,020
	12-Feb-15	17.0	<1.80	810	3,320
	18-Nov-14	15.6	<1.80	912	3,100
	19-Aug-14	13.9	<1.80	995	3,380
	20-May-14	12.7	2.10	1,010	3,350
	25-Feb-14	12.4	<1.66	965	3,320
	19-Nov-13	12.6	9.10	969	3,200
	14-Aug-13	11.4	4.20	1,030	3,350
13-May-13	9.98	<1.66	950	3,360	
14-Feb-13	9.30	2.10	1,110	3,580	
12-Nov-12	12.7	<1.72	1,170	3,830	
9-Aug-12	9.69	<1.72	1,300	4,010	
30-Apr-12	16.4	4.06	1,160	3,650	
7-Feb-12	14.8	<2.17	1,200	3,720	
4-Nov-11	10.7	3.5	1,300	4,060	
3-Aug-11	12.2	<2.17	1,290	3,600	
27-Apr-11	11.6	7.70	1,340	4,170	
25-Jan-11	19.1	<2.17	1,290	3,700	
20-Sep-10	19.6	<10.0	1,300	4,130	
27-Jun-10	14	<2.0	1,400	4,230	
6-Mar-10	23.7	<0.3	1,400	3,880	
16-Jan-10	22.6	0.4	1,300	3,630	
15-Sep-09	19.9	0.8	1,260	3,625	
3-Jun-09	29.4	0.4	1,340	3,905	
14-Mar-09	26.5	0.4	1,240	3,655	

**TABLE 5. DISCHARGE PLAN MONITORING WELL GROUNDWATER ANALYTICAL RESULTS
DONA ANA DAIRIES, DONA ANA COUNTY, NEW MEXICO**

Monitoring Well	Date Sampled	Nitrate as N (mg/l)	TKN (mg/l)	Chloride (mg/l)	TDS (mg/l)
624-04	28-Jan-20	Plugged and Abandoned			
	15-Nov-19	Dry			
	13-Aug-19	Dry			
	20-May-19	Dry			
	28-Feb-19	Dry			
	20-Nov-18	Dry			
	29-Aug-18	Dry			
	22-May-18	Dry			
	14-Feb-18	Dry			
	14-Nov-17	Dry			
	15-Aug-17	Dry			
	23-May-17	Dry			
	22-Feb-17	Dry			
	14-Nov-16	Dry			
	19-Aug-16	Dry			
	19-May-16	Dry			
	16-Feb-16	Dry			
	10-Nov-15	Dry			
	7-Aug-15	Dry			
	19-May-15	Dry			
	12-Feb-15	Dry			
	18-Nov-14	Dry			
	19-Aug-14	Dry			
	20-May-14	Dry			
	25-Feb-14	Dry			
	19-Nov-13	Dry			
	14-Aug-13	Dry			
	13-May-13	Dry			
	14-Feb-13	Dry			
	12-Nov-12	Dry			
	9-Aug-12	Dry			
	30-Apr-12	Dry			
	7-Feb-12	Dry			
4-Nov-11	Dry				
3-Aug-11	1.84	<2.17	478	2,760	
27-Apr-11	2.60	5.74	566	2,830	
26-Jan-11	3.23	2.52	747	3,480	
21-Sep-10	6.0	<10.0	758	3,750	
27-Jun-10	3.7	1.4	810	3,950	
6-Mar-10	4.3	0.4	890	4,050	
16-Jan-10	4.2	0.7	800	3,845	
15-Sep-09	9.3	0.8	840	3,750	
3-Jun-09	16.0	0.6	520	2,900	
14-Mar-09	18.1	0.6	520	2,820	

**TABLE 5. DISCHARGE PLAN MONITORING WELL GROUNDWATER ANALYTICAL RESULTS
DONA ANA DAIRIES, DONA ANA COUNTY, NEW MEXICO**

Monitoring Well	Date Sampled	Nitrate as N (mg/l)	TKN (mg/l)	Chloride (mg/l)	TDS (mg/l)
624-05	28-Jan-20	Plugged and Abandoned			
	15-Nov-19	11	<2.0	320	1,900
	13-Aug-19	8.1	<1.0	380	1,970
	16-May-19	7.7	<5.0	370	1,850
	28-Feb-19	6.6	<1.0	370	1,920
	20-Nov-18	Dry			
	29-Aug-18	Dry			
	22-May-18	Dry			
	14-Feb-18	Dry			
	14-Nov-17	Dry			
	15-Aug-17	Dry			
	23-May-17	Dry			
	22-Feb-17	Dry			
	14-Nov-16	Dry			
	19-Aug-16	Dry			
	19-May-16	Dry			
	16-Feb-16	Dry			
	10-Nov-15	Dry			
	7-Aug-15	Dry			
	19-May-15	Dry			
	12-Feb-15	Dry			
	18-Nov-14	Dry			
	19-Aug-14	Dry			
	20-May-14	Dry			
	25-Feb-14	Dry			
	19-Nov-13	Dry			
	14-Aug-13	Dry			
	13-May-13	Dry			
	14-Feb-13	6.72	<1.72	508	2,040
	12-Nov-12	4.82	<1.72	440	2,200
	9-Aug-12	4.11	1.82	472	2,050
	30-Apr-12	3.70	2.10	346	1,710
	7-Feb-12	3.38	<2.17	411	2,040
4-Nov-11	2.58	4.20	385	1,980	
3-Aug-11	3.34	<2.17	1,080	1,940	
27-Apr-11	3.34	4.76	424	1,840	
26-Jan-11	3.62	<2.17	392	1,740	
21-Sep-10	11.9	<10.0	449	2,300	
27-Jun-10	27	< 5.0	480	2,450	
6-Mar-10	30.5	0.4	520	2,595	
16-Jan-10	21.4	0.9	520	2,605	
15-Sep-09	34.8	1.0	530	2,620	
3-Jun-09	33.8	1.3	500	2,650	
14-Mar-09	23.9	1.2	490	2,565	

**TABLE 5. DISCHARGE PLAN MONITORING WELL GROUNDWATER ANALYTICAL RESULTS
DONA ANA DAIRIES, DONA ANA COUNTY, NEW MEXICO**

Monitoring Well	Date Sampled	Nitrate as N (mg/l)	TKN (mg/l)	Chloride (mg/l)	TDS (mg/l)
624-06	28-Jan-20	Plugged and Abandoned			
	15-Nov-19	Dry			
	13-Aug-19	Dry			
	20-May-19	Dry			
	28-Feb-19	Dry			
	20-Nov-18	Dry			
	29-Aug-18	Dry			
	22-May-18	Dry			
	14-Feb-18	Dry			
	14-Nov-17	Dry			
	15-Aug-17	Dry			
	23-May-17	Dry			
	22-Feb-17	Dry			
	14-Nov-16	Dry			
	19-Aug-16	Dry			
	19-May-16	Dry			
	16-Feb-16	Dry			
	10-Nov-15	Dry			
	7-Aug-15	Dry			
	19-May-15	Dry			
	12-Feb-15	Dry			
	18-Nov-14	Dry			
	19-Aug-14	Dry			
	20-May-14	Dry			
	25-Feb-14	Dry			
	19-Nov-13	Dry			
	14-Aug-13	Dry			
	13-May-13	Dry			
	14-Feb-13	31.5	<1.72	1,150	3,600
	12-Nov-12	28.3	<1.72	1,060	3,840
	9-Aug-12	30.8	7.56	1,080	3,420
	30-Apr-12	31.1	8.40	1,010	3,300
	7-Feb-12	30.9	6.30	1,080	3,020
4-Nov-11	29.5	8.68	1,040	2,860	
3-Aug-11	29.8	<2.17	1,080	3,240	
27-Apr-11	29.0	3.50	1,050	3,180	
26-Jan-11	29.1	2.94	1,080	2,760	
21-Sep-10	26.7	<10.0	1,060	3,270	
27-Jun-10	30	<5.0	1,100	3,570	
6-Mar-10	28.3	<0.3	1,250	3,550	
16-Jan-10	52.2	0.6	2,100	3,545	
15-Sep-09	27.8	0.7	1,150	3,425	
3-Jun-09	38.3	0.8	70	4,300	
14-Mar-09	36.5	0.3	1,300	3,800	

**TABLE 5. DISCHARGE PLAN MONITORING WELL GROUNDWATER ANALYTICAL RESULTS
DONA ANA DAIRIES, DONA ANA COUNTY, NEW MEXICO**

Monitoring Well	Date Sampled	Nitrate as N (mg/l)	TKN (mg/l)	Chloride (mg/l)	TDS (mg/l)
624-07	28-Jan-20	Plugged and Abandoned			
	15-Nov-19	Dry			
	13-Aug-19	Dry			
	20-May-19	Dry			
	28-Feb-19	Dry			
	20-Nov-18	Dry			
	29-Aug-18	Dry			
	22-May-18	Dry			
	14-Feb-18	Dry			
	14-Nov-17	Dry			
	15-Aug-17	Not Sampled - insufficient water to sample			
	23-May-17	Not Sampled - insufficient water to sample			
	22-Feb-17	Not Sampled - insufficient water to sample			
	14-Nov-16	Not Sampled - insufficient water to sample			
	19-Aug-16	Not Sampled - insufficient water to sample			
	19-May-16	Not Sampled - insufficient water to sample			
	16-Feb-16	Dry			
	10-Nov-15	Not Sampled - insufficient water to sample			
	7-Aug-15	Not Sampled - insufficient water to sample			
	19-May-15	Not Sampled - insufficient water to sample			
	12-Feb-15	Not Sampled - insufficient water to sample			
	17-Nov-14	Dry			
	19-Aug-14	Not Sampled - insufficient water to sample			
	20-May-14	Dry			
	26-Feb-14	Not Sampled - insufficient water to sample			
	19-Nov-13	Dry			
	14-Aug-13	Dry			
	13-May-13	Dry			
	14-Feb-13	Dry			
	12-Nov-12	Dry			
	9-Aug-12	Dry			
	30-Apr-12	Dry			
	7-Feb-12	Not Sampled - insufficient water to sample			
	4-Nov-11	Not Sampled - insufficient water to sample			
	3-Aug-11	8.01	<2.17	473	1,600
	27-Apr-11	19.4	3.50	539	2,290
	26-Jan-11	14.7	5.60	516	1,900
	21-Sep-10	20.5	<10.0	531	2,200
	27-Jun-10	61	<5.0	880	3,550
	6-Mar-10	43.4	<0.3	1,080	3,825
16-Jan-10	49.5	0.5	840	3,275	
15-Sep-09	50.1	0.4	960	3,280	
3-Jun-09	75.2	0.8	1,525	4,980	
14-Mar-09	54.3	0.3	1,160	3,580	

**TABLE 5. DISCHARGE PLAN MONITORING WELL GROUNDWATER ANALYTICAL RESULTS
DONA ANA DAIRIES, DONA ANA COUNTY, NEW MEXICO**

Monitoring Well	Date Sampled	Nitrate as N (mg/l)	TKN (mg/l)	Chloride (mg/l)	TDS (mg/l)
624-08	28-Jan-20	Plugged and Abandoned			
	15-Nov-19	Dry			
	13-Aug-19	Dry			
	16-May-19	Dry			
	28-Feb-19	Dry			
	20-Nov-18	Dry			
	29-Aug-18	Dry			
	22-May-18	Dry			
	14-Feb-18	Dry			
	14-Nov-17	Dry			
	15-Aug-17	Dry			
	23-May-17	Dry			
	22-Feb-17	Dry			
	14-Nov-16	Dry			
	19-Aug-16	Dry			
	19-May-16	Dry			
	16-Feb-16	Dry			
	10-Nov-15	Dry			
	7-Aug-15	Dry			
	19-May-15	Dry			
	12-Feb-15	Dry			
	18-Nov-14	Dry			
	19-Aug-14	Dry			
	20-May-14	Dry			
	26-Feb-14	Dry			
	19-Nov-13	Dry			
	14-Aug-13	Dry			
	13-May-13	Dry			
	14-Feb-13	Dry			
	9-Aug-12	Dry			
	30-Apr-12	Dry			
	7-Feb-12	Dry			
	4-Nov-11	Dry			
3-Aug-11	Dry				
27-Apr-11	2.45	3.50	200	1,400	
26-Jan-11	1.7	8.12	222	2,940	
21-Sep-10	<2.50	<10.0	197	1,200	
27-Jun-10	2.0	<1.0	220	1,310	
6-Mar-10	0.65	<0.3	280	1,330	
16-Jan-10	0.89	<0.3	240	1,215	
15-Sep-09	2.3	0.3	200	1,205	
3-Jun-09	1.7	0.7	210	1,280	
14-Mar-09	1.8	<0.2	205	1,165	

**TABLE 5. DISCHARGE PLAN MONITORING WELL GROUNDWATER ANALYTICAL RESULTS
DONA ANA DAIRIES, DONA ANA COUNTY, NEW MEXICO**

Monitoring Well	Date Sampled	Nitrate as N (mg/l)	TKN (mg/l)	Chloride (mg/l)	TDS (mg/l)
624-09	15-Nov-23	1.8	0.73	330	1,750
	16-Aug-23	<1.0	1.1	240	1,360
	11-May-23	<1.0	<1.0	250	1,470
	16-Feb-23	<1.0	<1.0	180	1,050
	14-Nov-22	<1.0	<1.0	140	1,020
	15-Aug-22	<0.50	<1.0	140	1,180
	13-May-22	2.4	1.7	270	1,700
	18-Feb-22	1.6	1.1	310	1,880
	10-Nov-21	2.8	1.5	370	2,010
	12-Aug-21	2.6	<2.0	380	2,070
	12-May-21	6.8	1.5	440	2,420
	19-Feb-21	13	11	600	2,820
	13-Nov-20	1.3	3.6	260	1,440
	17-Aug-20	3.5	2.5	370	1,970
	14-May-20	<1.0	2.2	320	1,480
13-Feb-20	<1.0	<2.0	320	2,130	
624-10	15-Nov-23	<1.0	0.79	570	2,870
	16-Aug-23	<1.0	<1.0	610	2,990
	11-May-23	<1.0	1.1	690	3,240
	16-Feb-23	<1.0	<1.0	550	2,860
	14-Nov-22	<1.0	1.1	510	2,760
	12-Aug-22	<1.0	<1.0	480	2,690
	12-May-22	5.8	<1.0	410	2,420
	18-Feb-22	14	<2.0	390	2,200
	10-Nov-21	8.9	1.7	440	2,330
	12-Aug-21	19	13	350	2,190
	12-May-21	17	<2.0	420	2,320
	19-Feb-21	2.9	<2.0	540	2,690
	13-Nov-20	2.3	1.4	500	2,710
	17-Aug-20	5.7	<2.0	520	2,700
	14-May-20	2.3	<2.0	490	2,640
13-Feb-20	4.2	8.7	450	2,720	
624-11	10-Nov-23	7.4	<0.50	1,700	4,150
	17-Aug-23	8.2	<1.0	1,600	4,110
	12-May-23	8.9	<1.0	1,300	3,600
	17-Feb-23	10	<1.0	1,200	3,500
	11-Nov-22	8.8	<1.0	1,200	3,500
	12-Aug-22	9.2	<1.0	1,100	3,230
	12-May-22	9.6	<1.0	1,000	3,340
	18-Feb-22	9.7	1.1	1,100	3,220
	11-Nov-21	9.8	<1.0	1,000	3,330
	27-Aug-21	14	<2.0	1,000	3,320
	14-May-21	11	<2.0	1,100	3,330
	19-Feb-21	11	<2.0	1,100	3,300
	12-Nov-20	11	2.2	1,100	3,200
17-Aug-20	11	<2.0	1,200	3,440	
15-May-20	12	<2.0	1,200	3,510	
13-Feb-20	9.2	7.0	910	3,650	

**TABLE 5. DISCHARGE PLAN MONITORING WELL GROUNDWATER ANALYTICAL RESULTS
DONA ANA DAIRIES, DONA ANA COUNTY, NEW MEXICO**

Monitoring Well	Date Sampled	Nitrate as N (mg/l)	TKN (mg/l)	Chloride (mg/l)	TDS (mg/l)
Gonzalez					
177-01	7-Aug-19	16	<2.0	1,500	4,260
	20-May-19	18	<2.0	1,600	4,230
	27-Feb-19	17	<2.0	1,600	4,290
	15-Nov-18	19	<2.0	1,500	4,250
	21-Aug-18	17	<2.0	1,400	4,350
	22-May-18	19	<2.0	1,500	4,260
	14-Feb-18	18	<2.0	1,600	4,310
	10-Nov-17	16.2	0.750	1,400	4,130
	14-Aug-17	20.2	1.21	1,400	4,220
	22-May-17	22.5	<0.0501	1,370	4,200
	22-Feb-17	24.0	<0.0501	1,380	4,330
	10-Nov-16	23.7	<0.937	1,380	4,090
	23-Aug-16	23.4	<0.937	1,420	4,030
	20-May-16	25.6	4.04	1,370	4,400
	11-Feb-16	28.9	1.68	1,400	4,100
	11-Nov-15	30.3	<1.18	1,370	4,260
	21-Aug-15	12.0	1.40	1,410	4,220
	13-May-15	30.4	<1.18	1,370	4,160
	11-Feb-15	33.5	<1.80	1,190	4,160
	13-Nov-14	34.6	<1.80	1,330	3,780
	18-Aug-14	30.5	2.80	1,100	3,780
	16-May-14	33.8	<1.80	1,380	3,840
	21-Feb-14	33.7	<1.66	1,310	3,870
	18-Nov-13	33.2	2.80	1,330	3,740
	13-Aug-13	32.2	4.20	1,370	3,850
	15-May-13	31.6	<1.66	1,300	3,940
	19-Feb-13	28.4	<1.72	1,310	3,930
	13-Nov-12	27.7	<1.72	1,190	3,780
	13-Aug-12	27.3	2.52	1,160	3,790
	26-Apr-12	28.5	<1.72	1,460	3,500
	6-Feb-12	28.1	<2.17	1,180	3,650
	3-Nov-11	27.4	2.66	1,170	3,790
2-Aug-11	26.0	2.24	1,200	4,000	
4-May-11	26.6	<2.17	1,160	4,020	
25-Jan-11	23.3	4.06	1,160	3,540	
20-Sep-10	17.6	12.7	1,120	3,480	
29-Jun-10	34	<1.0	1,200	3,660	
28-Apr-10	31	<5.0	1,200	3,680	
20-Jan-10	32	<5.0	1,200	3,640	
21-Oct-09	35	<5.0	1,100	3,700	
7-Jul-09	35	<5.0	1,400	3,700	
6-May-09	34	<5.0	1,300	3,700	
22-Jan-09	33	<5.0	1,300	3,700	

**TABLE 5. DISCHARGE PLAN MONITORING WELL GROUNDWATER ANALYTICAL RESULTS
DONA ANA DAIRIES, DONA ANA COUNTY, NEW MEXICO**

Monitoring Well	Date Sampled	Nitrate as N (mg/l)	TKN (mg/l)	Chloride (mg/l)	TDS (mg/l)
177-02	7-Aug-19	7.7	<1.0	290	1,590
	20-May-19	9.8	<2.0	380	1,800
	27-Feb-19	15	<2.0	580	2,380
	15-Nov-18	7.3	<1.0	280	1,590
	21-Aug-18	15	2.2	590	2,480
	22-May-18	4.7	<1.0	200	1,460
	14-Feb-18	7.4	<1.0	330	1,940
	10-Nov-17	7.89	0.901	247	1,820
	14-Aug-17	24.5	<0.0500	1,050	3,300
	22-May-17	27.4	<0.0501	1,010	3,090
	22-Feb-17	25.0	0.389	911	2,960
	10-Nov-16	20.4	1.14	894	2,800
	23-Aug-16	21.9	<0.937	967	2,980
	20-May-16	22.1	<2.24	798	3,040
	11-Feb-16	24.4	<1.18	847	2,820
	11-Nov-15	20.3	<1.18	824	2,800
	21-Aug-15	18.2	<1.18	797	2,840
	13-May-15	17.3	1.40	923	2,980
	12-Feb-15	17.5	<1.80	835	3,160
	14-Nov-14	16.3	<1.80	931	2,930
	18-Aug-14	17.1	<1.80	864	2,810
	16-May-14	43.0	<1.80	803	2,980
	21-Feb-14	67.9	<1.66	725	3,180
	18-Nov-13	111	2.80	682	3,150
	13-Aug-13	30.7	4.20	794	3,020
	15-May-13	27.6	<1.66	910	3,000
	19-Feb-13	29.3	<1.72	902	3,100
	13-Nov-12	35.8	<1.72	870	3,320
	13-Aug-12	47.4	7.70	899	3,650
	26-Apr-12	36.0	<1.72	881	2,960
	6-Feb-12	37.0	<2.17	958	3,320
	3-Nov-11	32.7	<2.17	971	3,450
	3-Aug-11	34.4	2.80	997	3,340
4-May-11	38.1	2.52	1,050	3,580	
25-Jan-11	31.6	3.36	1,050	3,640	
20-Sep-10	78.0	<10.0	964	3,630	
29-Jun-10	58	<1.0	1,000	3,830	
28-Apr-10	60	<5.0	1,100	3,860	
20-Jan-10	59	<5.0	1,200	4,020	
21-Oct-09	50	<5.0	1,200	4,000	
7-Jul-09	56	<5.0	1,300	4,000	
6-May-09	52	<5.0	1,200	4,000	
22-Jan-09	72	<5.0	1,300	4,000	

**TABLE 5. DISCHARGE PLAN MONITORING WELL GROUNDWATER ANALYTICAL RESULTS
DONA ANA DAIRIES, DONA ANA COUNTY, NEW MEXICO**

Monitoring Well	Date Sampled	Nitrate as N (mg/l)	TKN (mg/l)	Chloride (mg/l)	TDS (mg/l)
177-03A	13-Aug-19	14	<2.0	670	2,800
	20-May-19	15	<2.0	690	2,670
	27-Feb-19	14	<2.0	680	2,770
	20-Nov-18	12	<2.0	590	2,700
	21-Aug-18	2.9	<1.0	400	1,800
	22-May-18	13	<2.0	700	2,650
	15-Feb-18	3.70	<1.0	510	1,770
	10-Nov-17	2.76	2.29	455	2,010
	15-Aug-17	8.78	1.58	526	2,860
	22-May-17	7.50	0.362	601	2,440
	23-Feb-17	7.69	<0.0501	693	2,670
	11-Nov-16	7.30	<0.937	333	2,540
	24-Aug-16	14.9	<0.937	1,130	3,990
	20-May-16	5.41	<2.24	768	2,620
	12-Feb-16	16.9	<1.18	1,270	4,220
	11-Nov-15	5.67	<1.18	821	2,760
	21-Aug-15	6.35	<1.18	745	2,600
	14-May-15	9.94	<1.18	871	2,900
	11-Feb-15	17.7	<1.80	1,020	3,880
	13-Nov-14	0.993	<1.80	486	1,780
	19-Aug-14	10.9	<1.80	859	2,720
	19-May-14	11.4	<1.80	950	3,220
	24-Feb-14	15.6	2.10	1,160	3,900
	18-Nov-13	14.3	2.10	1,150	3,490
	13-Aug-13	17.1	2.80	1,230	4,120
	15-May-13	16.0	<1.66	1,150	3,530
	18-Feb-13	15.5	<1.72	1,290	3,900
	13-Nov-12	12.2	<1.72	1,150	3,900
	13-Aug-12	7.86	<1.72	835	2,810
	26-Apr-12	1.16	<1.72	378	1,430
6-Feb-12	2.00	<2.17	452	1,580	
4-Nov-11	<0.500	3.50	436	1,850	

**TABLE 5. DISCHARGE PLAN MONITORING WELL GROUNDWATER ANALYTICAL RESULTS
DONA ANA DAIRIES, DONA ANA COUNTY, NEW MEXICO**

Monitoring Well	Date Sampled	Nitrate as N (mg/l)	TKN (mg/l)	Chloride (mg/l)	TDS (mg/l)
177-04	13-Aug-19	14	<2.0	830	3,210
	20-May-19	14	<2.0	840	3,200
	27-Feb-19	16	<2.0	930	3,370
	20-Nov-18	15	<2.0	880	3,400
	21-Aug-18	15	<2.0	810	3,450
	22-May-18	16	<2.0	900	3,590
	15-Feb-18	16	<2.0	1,000	3,640
	10-Nov-17	16.2	2.46	983	3,390
	16-Aug-17	17.0	<0.0500	1,090	3,700
	22-May-17	16.4	0.921	1,130	3,880
	23-Feb-17	18.0	<0.0501	1,140	3,810
	11-Nov-16	14.8	<0.937	1,040	4,020
	24-Aug-16	14.5	<0.937	647	4,220
	23-May-16	0.329	<2.24	378	1,440
	12-Feb-16	49.8	<1.18	1,070	4,080
	11-Nov-15	19.3	7.28	1,360	4,080
	21-Aug-15	7.50	<1.18	1,420	4,040
	14-May-15	19.4	<1.18	1,330	3,910
	12-Feb-15	18.7	<1.80	1,110	3,730
	13-Nov-14	22.5	<1.80	1,190	3,680
	19-Aug-14	18.2	<1.80	1,150	3,830
	19-May-14	17.5	<1.80	1,320	3,970
	24-Feb-14	17.6	<1.66	1,290	4,020
	18-Nov-13	23.0	2.80	1,260	3,850
	13-Aug-13	19.1	2.10	1,270	3,530
	15-May-13	19.4	<1.66	1,110	3,600
	18-Feb-13	20.5	<1.72	1,120	3,450
	13-Nov-12	22.3	<1.72	1,070	3,630
	13-Aug-12	19.7	<1.72	1,000	3,720
	26-Apr-12	21.7	<1.72	1,050	3,480
	2-Feb-12	22.5	<2.17	1,100	3,650
	3-Nov-11	27.5	<2.17	1,100	3,500
	2-Aug-11	21.6	<2.17	1,080	3,670
	4-May-11	21.2	3.64	1,100	3,740
	25-Jan-11	17.5	2.38	1,150	3,760
	20-Sep-10	4.83	<10.0	1,180	4,030
	29-Jun-10	26	<1.0	1,200	4,010
	28-Apr-10	26	<5.0	1,300	4,090
	20-Jan-10	27	<5.0	1,400	4,090
	21-Oct-09	29	<5.0	1,400	4,100
7-Jul-09	32	<5.0	1,400	3,990	
6-May-09	32	<5.0	1,300	3,800	
22-Jan-09	26	<5.0	1,200	1,700	

**TABLE 5. DISCHARGE PLAN MONITORING WELL GROUNDWATER ANALYTICAL RESULTS
DONA ANA DAIRIES, DONA ANA COUNTY, NEW MEXICO**

Monitoring Well	Date Sampled	Nitrate as N (mg/l)	TKN (mg/l)	Chloride (mg/l)	TDS (mg/l)
177-05	13-Aug-19	24	<5.0	1,400	4,180
	20-May-19	30	<5.0	1,400	4,080
	27-Feb-19	24	<5.0	1,400	4,090
	20-Nov-18	27	<5.0	1,300	4,020
	21-Aug-18	28	<5.0	1,300	4,260
	22-May-18	32	<5.0	1,300	4,240
	15-Feb-18	33	<5.0	1,600	4,380
	10-Nov-17	30.8	0.112	1,350	4,100
	15-Aug-17	36.2	0.605	1,450	4,490
	22-May-17	31.2	0.621	1,390	4,250
	23-Feb-17	50.2	<0.0501	1,170	3,550
	11-Nov-16	27.4	<0.937	1,170	3,900
	24-Aug-16	25.4	<0.937	1,340	3,930
	20-May-16	27.4	<2.24	1,290	4,030
	12-Feb-16	17.8	3.36	1,380	3,330
	11-Nov-15	30.8	7.28	1,230	3,840
	21-Aug-15	34.0	<1.18	1,300	3,920
	13-May-15	46.5	<1.18	1,110	3,440
	11-Feb-15	36.8	<1.80	1,250	4,060
	13-Nov-14	56.1	<1.80	1,110	3,260
	19-Aug-14	18.1	<1.80	1,680	4,800
	19-May-14	35.7	<1.80	1,400	4,000
	24-Feb-14	26.6	<1.66	1,600	4,460
	18-Nov-13	33.5	2.10	1,580	4,360
	13-Aug-13	30.5	2.80	1,640	4,420
	15-May-13	29.8	<1.66	1,510	4,160
	18-Feb-13	32.6	<1.72	1,430	3,900
	13-Nov-12	37.1	<1.72	1,240	4,050
	13-Aug-12	37.6	2.66	1,390	4,360
	26-Apr-12	47.1	<1.72	1,090	3,440
	2-Feb-12	42.2	<2.17	1,170	3,590
	3-Nov-11	30.6	<2.17	1,190	3,060
	2-Aug-11	36.3	<2.17	1,120	3,420
	4-May-11	40.6	5.60	1,090	3,500
25-Jan-11	39.2	2.10	1,060	3,240	
20-Sep-10	7.39	<10.0	1,050	3,500	
29-Jun-10	39	<1.0	1,100	3,470	
28-Apr-10	40	<5.0	1,200	3,460	
20-Jan-10	43	<5.0	1,100	3,330	
21-Oct-09	50	<5.0	1,100	3,300	
7-Jul-09	38	<5.0	1,200	3,270	
6-May-09	40	<5.0	1,100	3,100	
22-Jan-09	40	<5.0	1,100	3,000	

**TABLE 5. DISCHARGE PLAN MONITORING WELL GROUNDWATER ANALYTICAL RESULTS
DONA ANA DAIRIES, DONA ANA COUNTY, NEW MEXICO**

Monitoring Well	Date Sampled	Nitrate as N (mg/l)	TKN (mg/l)	Chloride (mg/l)	TDS (mg/l)	
177-06	13-Aug-19				Dry	
	8-May-19				Dry	
	27-Feb-19				Dry	
	20-Nov-18				Dry	
	21-Aug-18				Dry	
	22-May-18				Dry	
	15-Feb-18				Dry	
	10-Nov-17				Dry	
	14-Aug-17				Dry	
	22-May-17				Dry	
	23-Feb-17				Dry	
	11-Nov-16				Dry	
	24-Aug-16				Dry	
	23-May-16				Dry	
	12-Feb-16				Dry	
	11-Nov-15				Dry	
	21-Aug-15				Dry	
	13-May-15				Dry	
	11-Feb-15				Dry	
	13-Nov-14				Dry	
	13-Aug-14				Dry	
	13-Aug-14				Dry	
	19-May-14				Dry	
	24-Feb-14				Dry	
	21-Nov-13	24.1	14.0	1,080	3,110	
	18-Nov-13	Not Sampled - insufficient water to sample				
	13-Aug-13	Not Sampled - insufficient water to sample				
	15-May-13	Not Sampled - insufficient water to sample				
	18-Feb-13	17.4	<1.72	963	3,000	
	13-Nov-12	16.1	<1.72	918	3,020	
	26-Apr-12	Dry				
	2-Feb-12	16.1	4.76	934	2,940	
	7-Dec-11	15.1	<2.17	892	2,760	
	2-Aug-11	16.1	<2.17	910	3,020	
	4-May-11	17.2	4.90	955	2,930	
	25-Jan-11	19.2	<2.05	923	2,740	
	20-Sep-10	<2.50	<10.0	890	2,880	
	29-Jun-10	23	<1.0	940	2,960	
	28-Apr-10	21	<5.0	980	2,960	
	20-Jan-10	26	<5.0	1,000	2,910	
21-Oct-09	25	<5.0	980	2,900		
7-Jul-09	25	<5.0	1,000	2,850		
6-May-09	25	<5.0	1,000	2,800		
22-Jan-09	23	<5.0	960	2,800		

**TABLE 5. DISCHARGE PLAN MONITORING WELL GROUNDWATER ANALYTICAL RESULTS
DONA ANA DAIRIES, DONA ANA COUNTY, NEW MEXICO**

Monitoring Well	Date Sampled	Nitrate as N (mg/l)	TKN (mg/l)	Chloride (mg/l)	TDS (mg/l)
177-07	15-Mar-03	44.4	1.5	1,205	4,007
177-07R	7-Aug-19	22	<5.0	790	3,000
	20-May-19	23	<5.0	850	3,030
	27-Feb-19	25	<5.0	860	3,110
	20-Nov-18	25	<5.0	840	3,170
	21-Aug-18	26	<5.0	920	3,380
	22-May-18	28	<5.0	1,000	3,490
	14-Feb-18	28	<5.0	1,000	3,500
	10-Nov-17	30.2	<0.0500	1,070	3,330
	14-Aug-17	32.6	<0.0500	1,100	3,680
	22-May-17	29.5	<0.0501	1,080	3,680
	23-Feb-17	38.5	<0.0501	1,070	3,550
	11-Nov-16	35.2	<0.937	1,020	3,560
	23-Aug-16	40.0	<0.937	2,250	3,650
	23-May-16	42.1	<2.24	1,040	3,580
	11-Feb-16	39.5	<1.18	1,100	3,600
	11-Nov-15	37.1	12.9	1,110	3,480
	21-Aug-15	35.0	<1.18	1,170	3,600
	14-May-15	45.1	<1.18	1,130	3,580
	12-Feb-15	46.9	<1.80	1,070	3,510
	14-Nov-14	45.3	<1.80	1,070	3,250
	19-Aug-14	28.2	<1.80	980	3,120
	19-May-14	22.7	2.10	895	2,910
	24-Feb-14	22.7	<1.66	903	3,080
	18-Nov-13	21.5	2.10	911	3,060
	13-Aug-13	30.3	2.80	1,010	3,540
	15-May-13	29.2	<1.66	1,000	3,420
	19-Feb-13	31.0	<1.72	976	3,360
13-Nov-12	31.0	<1.72	1,040	3,570	
13-Aug-12	26.5	<1.72	1,040	3,670	
26-Apr-12	22.8	<1.72	1,010	2,690	
6-Feb-12	28.5	5.60	1,060	2,730	
4-Nov-11	29.3	2.66	1,050	2,830	
3-Aug-11	25.2	2.80	1,050	3,250	
7-Apr-11	21.4	2.52	1,070	8,660	
NMWQCC Standard		10	NA	250	1,000
Existing Conditions - August 2020		NA	NA	1,800	1,598
Existing Conditions - Pre-August 2020*		NA	NA	1,015	3,178

**TABLE 5. DISCHARGE PLAN MONITORING WELL GROUNDWATER ANALYTICAL RESULTS
DONA ANA DAIRIES, DONA ANA COUNTY, NEW MEXICO**

Monitoring Well	Date Sampled	Nitrate as N (mg/l)	TKN (mg/l)	Chloride (mg/l)	TDS (mg/l)
Central Area					
Buena Vista Dairy II					
74-01	17-Nov-23	30	<0.50	820	2,830
	18-Aug-23	31	<5.0	790	2,830
	15-May-23	43	<5.0	770	2,950
	17-Feb-23	29	<5.0	770	2,980
	15-Nov-22	27	<5.0	800	2,980
	16-Aug-22	25	<5.0	800	3,000
	13-May-22	15	<2.0	780	3,020
	22-Feb-22	7.2	<1.0	850	2,940
	12-Nov-21	17	<2.0	880	3,130
	7-Sep-21	35	<5.0	900	3,410
	17-May-21	11	<2.0	980	3,590
	22-Feb-21	8.6	3.6	1,100	3,940
	17-Nov-20	5.9	3.9	1,200	9,800
	21-Aug-20	17	<2.0	820	2,790
	18-May-20	66	<5.0	1,100	3,570
	14-Feb-20	72	<5.0	1,200	4,050
	19-Nov-19	68	<5.0	1,100	3,960
	14-Aug-19	24	<5.0	820	2,910
	21-May-19	39	<5.0	850	3,110
	28-Feb-19	52	<5.0	930	3,460
	16-Nov-18	65	<5.0	1,100	3,820
	29-Aug-18	64	<5.0	1,100	3,000
	23-May-18	34	<5.0	790	3,140
	19-Feb-18	49	<5.0	960	3,290
	14-Nov-17	41.5	<0.0500	871	3,100
	16-Aug-17	56.7	<0.0500	1,030	3,590
	26-May-17	26.2	<0.0501	756	2,810
	24-Feb-17	35.2	<0.300	799	3,060
	14-Nov-16	46.8	<0.937	702	3,360
	24-Aug-16	60.2	<0.937	1,000	3,690
	25-May-16	51.1	<2.24	739	3,060
	18-Feb-16	32.1	<1.18	763	2,840
	12-Nov-15	15.9	12.3	725	2,630
	24-Aug-15	67.4	<1.18	902	3,360
	19-May-15	59.2	2.80	784	3,060
	13-Feb-15	59.9	<1.80	812	3,160
	19-Nov-14	23.9	<1.80	891	2,930
	20-Aug-14	76.2	<1.80	866	3,480
	20-May-14	62.6	2.10	816	3,080
	3-Mar-14	57.2	2.10	855	3,200
19-Nov-13	63.6	4.20	898	3,210	
21-Aug-13	63.9	2.80	829	3,180	
16-May-13	72.3	<1.66	816	3,090	
19-Feb-13	59.1	<1.72	840	3,140	
14-Nov-12	94.2	8.40	963	3,510	
10-Aug-12	78.6	3.50	922	2,150	
3-May-12	65.3	<1.72	778	3,265	
8-Feb-12	Not Sampled				
3-Nov-11	64.6	<2.17	811	2,830	
1-Aug-11	73.2	<2.17	770	3,040	
26-Apr-11	67.8	<2.17	730	3,300	
25-Jan-11	41.7	13.0	738	2,960	
17-Sep-10	36.7	<10.0	695	2,760	
29-Jun-10	74	<1.0	850	3,350	
24-Mar-10	70	ND	840	3,070	
14-Dec-09	84	0.14	750	2,480	
1-Sep-09	92	ND	730	2,914	
2-Jun-09	33.2	ND	650	2,632	
3-Mar-09	43.8	ND	735	2,666	

**TABLE 5. DISCHARGE PLAN MONITORING WELL GROUNDWATER ANALYTICAL RESULTS
DONA ANA DAIRIES, DONA ANA COUNTY, NEW MEXICO**

Monitoring Well	Date Sampled	Nitrate as N (mg/l)	TKN (mg/l)	Chloride (mg/l)	TDS (mg/l)
74-02	17-Nov-23	7.8	0.71	850	3,010
	18-Aug-23	<1.0	1.4	650	2,540
	12-May-23	1.3	2.2	650	2,500
	17-Feb-23	4.3	1.3	670	2,440
	14-Nov-22	<1.0	1.8	620	2,460
	15-Aug-22	<0.50	1.8	680	2,480
	13-May-22	<1.0	2.2	630	2,430
	22-Feb-22	<1.0	2.2	650	2,360
	11-Nov-21	<1.0	3.4	600	2,470
	7-Sep-21	<0.50	2.2	690	2,550
	14-May-21	<1.0	7.8	650	3,220
	22-Feb-21	<1.0	4.2	650	9,470
	17-Nov-20	30	13	510	18,900
	21-Aug-20	44	<5.0	600	2,410
	15-May-20	43	<5.0	610	2,430
	14-Feb-20	43	<5.0	640	2,540
	19-Nov-19	37	<5.0	640	2,630
	14-Aug-19	38	<5.0	560	2,310
	21-May-19	37	<5.0	600	2,380
	28-Feb-19	36	<5.0	560	2,400
	15-Nov-18	31	<5.0	550	2,230
	23-Aug-18	27	<5.0	490	2,220
	23-May-18	33	<5.0	560	2,360
	15-Feb-18	26	<5.0	640	2,260
	14-Nov-17	23.5	<0.0500	521	2,110
	15-Aug-17	23.5	<0.0500	539	2,100
	25-May-17	25.6	<0.0501	548	2,470
	24-Feb-17	33.4	<0.300	587	2,240
	14-Nov-16	34.4	7.95	603	2,440
	24-Aug-16	37.6	<0.937	581	2,480
	25-May-16	40.7	<2.24	593	2,480
	18-Feb-16	29.9	<1.18	592	2,420
	11-Nov-15	22.5	14.0	562	2,120
	24-Aug-15	26.1	<1.18	566	2,270
	19-May-15	20.7	1.40	527	2,180
	13-Feb-15	23.5	<1.80	519	2,300
	19-Nov-14	28.6	<1.80	572	2,230
	20-Aug-14	29.8	<1.80	567	2,360
	20-May-14	25.7	2.10	579	2,230
	3-Mar-14	24.7	<1.66	588	2,260
20-Nov-13	28.8	2.10	625	2,340	
21-Aug-13	20.0	2.80	564	2,220	
16-May-13	15.5	<1.66	549	2,120	
19-Feb-13	13.9	<1.72	525	1,900	
14-Nov-12	12.7	2.10	484	2,150	
10-Aug-12	14.0	2.10	532	2,060	
3-May-12	16.4	<1.72	495	1,980	
8-Feb-12	15.2	5.46	519	2,150	
3-Nov-11	26.3	<2.17	558	2,510	
29-Jul-11	52.8	2.24	630	2,710	
26-Apr-11	93.2	<2.17	831	3,610	
25-Jan-11	65.7	2.80	824	3,670	
17-Sep-10	30.6	<10.0	665	2,400	
29-Jun-10	45	<1.0	730	2,780	
24-Mar-10	20.6	ND	810	2,612	
14-Dec-09	14.6	0.14	770	2,452	
1-Sep-09	17.3	0.7	760	2,474	
2-Jun-09	17.6	0.84	820	4,866	
3-Mar-09	45.1	ND	1,265	4,556	

**TABLE 5. DISCHARGE PLAN MONITORING WELL GROUNDWATER ANALYTICAL RESULTS
DONA ANA DAIRIES, DONA ANA COUNTY, NEW MEXICO**

Monitoring Well	Date Sampled	Nitrate as N (mg/l)	TKN (mg/l)	Chloride (mg/l)	TDS (mg/l)
74-03	17-Nov-23	<1.0	<0.50	220	1,650
	18-Aug-23	<1.0	<1.0	210	1,260
	12-May-23	<1.0	<1.0	250	1,670
	17-Feb-23	2.7	<1.0	300	1,690
	14-Nov-22	1.2	<1.0	220	1,490
	15-Aug-22	0.61	<1.0	240	1,360
	13-May-22	<1.0	<1.0	200	1,240
	22-Feb-22	<1.0	<1.0	250	1,340
	11-Nov-21	<1.0	<1.0	230	1,420
	27-Aug-21	<1.0	<1.0	240	1,570
	14-May-21	<1.0	<1.0	250	1,440
	22-Feb-21	<1.0	<1.0	260	1,500
	17-Nov-20	<0.50	<1.0	250	1,460
	19-Aug-20	<1.0	<1.0	240	1,570
	15-May-20	<1.0	<1.0	260	1,570
	14-Feb-20	<1.0	<2.0	260	1,510
	19-Nov-19	<1.0	<2.0	230	1,550
	14-Aug-19	<1.0	<2.0	260	1,520
	21-May-19	<1.0	<1.0	260	1,390
	28-Feb-19	<1.0	<1.0	250	1,550
	15-Nov-18	1.0	<1.0	300	1,760
	23-Aug-18	1.2	<1.0	360	1,900
	23-May-18	1.4	<1.0	430	2,000
	15-Feb-18	1.4	<1.0	530	2,100
	14-Nov-17	1.21	0.0626	548	2,340
	15-Aug-17	0.187	1.35	514	2,150
	25-May-17	0.941	0.187	641	2,640
	24-Feb-17	0.209	<0.300	668	2,520
	14-Nov-16	1.25	<0.937	654	2,500
	24-Aug-16	3.36	2.27	728	2,590
	25-May-16	0.646	<2.24	693	2,780
	18-Feb-16	<0.194	<1.18	804	2,920
	12-Nov-15	<0.194	3.36	1,000	3,480
	24-Aug-15	<0.194	<1.18	1,190	3,960
	19-May-15	1.02	1.40	1,310	4,300
	13-Feb-15	1.07	<1.80	1,260	4,330
	19-Nov-14	2.06	<1.80	1,380	4,390
	20-Aug-14	2.77	<1.80	1,240	4,380
	20-May-14	3.51	2.10	1,230	4,000
	3-Mar-14	5.75	<1.66	1,220	4,140
	20-Nov-13	10.7	2.80	1,200	4,070
	21-Aug-13	5.62	3.50	1,230	4,100
	16-May-13	7.88	<1.66	1,160	3,920
	19-Feb-13	2.81	<1.72	1,250	4,480
	14-Nov-12	1.06	<1.72	1,300	4,440
	10-Aug-12	2.25	<1.72	1,450	4,900
	3-May-12	9.92	<1.72	1,330	3,920
	8-Feb-12	11.0	<2.17	1,420	4,170
	3-Nov-11	27.6	<2.17	1,420	4,730
	1-Aug-11	15.0	<2.17	1,450	4,870
	26-Apr-11	4.17	<2.17	1,480	4,690
	25-Jan-11	2.02	<2.17	1,460	4,960
	20-Sep-10	21.3	<10.0	1,490	4,840
	29-Jun-10	1.5	<1.0	1,400	4,630
	24-Mar-10	6.1	ND	1,530	4,400
	14-Dec-09	14.1	ND	1,550	4,560
	1-Sep-09	18.9	ND	1,630	4,734
	2-Jun-09	2.9	ND	1,590	1,782
	3-Mar-09	2.65	ND	1,510	4,664

**TABLE 5. DISCHARGE PLAN MONITORING WELL GROUNDWATER ANALYTICAL RESULTS
DONA ANA DAIRIES, DONA ANA COUNTY, NEW MEXICO**

Monitoring Well	Date Sampled	Nitrate as N (mg/l)	TKN (mg/l)	Chloride (mg/l)	TDS (mg/l)
74-04	17-Nov-23	10	<0.50	680	2,270
	21-Aug-23	13	<2.0	640	2,160
	15-May-23	12	<2.0	460	1,830
	21-Feb-23	13	<2.0	670	2,280
	15-Nov-22	16	<2.0	580	2,170
	16-Aug-22	12	<2.0	630	2,150
	16-May-22	11	<2.0	590	2,080
	23-Feb-22	12	<2.0	730	2,300
	12-Nov-21	12	<2.0	620	2,280
	7-Sep-21	<0.50	<1.0	610	2,030
	17-May-21	8.1	<1.0	580	2,160
	22-Feb-21	11	<1.0	690	2,140
	17-Nov-20	<0.50	2.2	530	3,840
	21-Aug-20	11	<2.0	640	2,200
	18-May-20	10	<2.0	470	1,670
	14-Feb-20	12	<2.0	600	2,120
	20-Nov-19	12	<2.0	630	2,180
	14-Aug-19	11	<2.0	640	2,250
	21-May-19	15	<2.0	490	1,890
	1-Mar-19	12	<2.0	600	2,140
	16-Nov-18	12	<2.0	620	2,140
	31-Aug-18	12	<2.0	590	2,140
	23-May-18	12	<2.0	580	2,060
	19-Feb-18	9.2	<1.0	500	1,960
	14-Nov-17	10.6	<0.0500	532	1,840
	16-Aug-17	11.6	<0.0500	569	2,020
	26-May-17	18.6	<0.0501	516	1,910
	24-Feb-17	11.5	<0.300	555	1,920
	15-Nov-16	11.3	1.14	551	2,070
	25-Aug-16	13.1	<0.937	596	2,060
	25-May-16	20.0	<2.24	530	2,060
	18-Feb-16	12.9	<1.18	582	2,010
	12-Nov-15	13.5	2.24	584	2,040
	24-Aug-15	21.7	<1.18	576	2,120
	20-May-15	22.4	<1.18	524	1,900
	16-Feb-15	13.4	2.10	491	1,520
	20-Nov-14	14.7	<1.80	538	2,140
	21-Aug-14	16.3	<1.80	556	2,060
	21-May-14	20.1	<1.80	537	1,880
	3-Mar-14	18.1	<1.66	565	2,080
	19-Nov-13	17.3	2.10	570	1,910
	22-Aug-13	16.4	3.50	560	2,160
16-May-13	17.6	<1.66	502	1,890	
20-Feb-13	18.5	<1.72	499	1,960	
14-Nov-12	19.3	<1.72	499	2,140	
10-Aug-12	18.8	<1.72	477	1,920	
3-May-12	33.6	<1.72	436	1,800	
8-Feb-12	31.6	<2.17	473	2,020	
3-Nov-11	13.4	<2.17	439	1,080	
29-Jul-11	15.3	<2.17	438	1,580	
26-Apr-11	12.8	<2.17	451	1,820	
25-Jan-11	6.50	<2.17	434	1,810	
20-Sep-10	10.6	<10.0	441	1,640	
29-Jun-10	15	<1.0	500	1,840	
24-Mar-10	11.4	0.28	570	1,792	
14-Dec-09	11.5	ND	560	1,738	
1-Sep-09	19.3	ND	550	1,792	
2-Jun-09	7.2	ND	570	2,024	
3-Mar-09	20.3	ND	530	1,884	

**TABLE 5. DISCHARGE PLAN MONITORING WELL GROUNDWATER ANALYTICAL RESULTS
DONA ANA DAIRIES, DONA ANA COUNTY, NEW MEXICO**

Monitoring Well	Date Sampled	Nitrate as N (mg/l)	TKN (mg/l)	Chloride (mg/l)	TDS (mg/l)
74-05	17-Nov-23	16	<0.50	630	2,200
	21-Aug-23	16	<2.0	620	2,250
	15-May-23	20	<5.0	600	2,170
	21-Feb-23	15	<2.0	630	2,240
	15-Nov-22	15	<2.0	580	2,230
	16-Aug-22	16	<2.0	660	2,270
	16-May-22	15	<2.0	680	2,210
	23-Feb-22	13	<2.0	660	2,190
	15-Nov-21	13	<2.0	<0.50	2,200
	31-Aug-21	14	<2.0	670	2,160
	17-May-21	11	<2.0	790	2,280
	23-Feb-21	6.3	2.2	690	2,210
	17-Nov-20	<0.50	4.2	610	3,320
	21-Aug-20	14	<2.0	630	2,170
	18-May-20	15	<2.0	650	2,160
	14-Feb-20	14	<2.0	600	2,050
	20-Nov-19	14	<2.0	540	2,080
	13-Aug-19	14	<2.0	580	2,100
	21-May-19	15	<2.0	580	2,160
	1-Mar-19	15	<2.0	590	2,140
	16-Nov-18	14	<2.0	560	2,070
	29-Aug-18	14	<2.0	560	2,890
	23-May-18	14	<2.0	580	2,110
	19-Feb-18	14	<2.0	570	2,100
	14-Nov-17	12.0	<0.0500	539	1,860
	16-Aug-17	12.7	<0.0500	561	1,950
	26-May-17	13.4	<0.0501	590	2,140
	24-Feb-17	12.8	<0.300	568	2,080
	15-Nov-16	12.0	<0.937	560	2,020
	25-Aug-16	14.7	<0.937	455	2,040
	25-May-16	15.6	<2.24	533	2,010
	18-Feb-16	15.3	2.24	569	2,040
	12-Nov-15	15.4	<1.18	561	2,020
	24-Aug-15	22.7	<1.18	505	2,040
	20-May-15	20.0	<1.18	495	1,960
	16-Feb-15	16.9	<1.80	504	1,840
	20-Nov-14	17.3	<1.80	493	1,890
	21-Aug-14	18.8	<1.8	464	1,880
	21-May-14	19.8	<1.80	452	1,860
	25-Feb-14	18.3	<1.66	506	1,960
	19-Nov-13	18.4	<1.66	493	1,840
	22-Aug-13	18.8	4.2	497	1,980
	16-May-13	17.5	<1.66	469	1,860
	20-Feb-13	17.8	<1.72	470	1,870
	14-Nov-12	17.0	<1.72	219	1,900
10-Aug-12	18.0	<1.72	463	1,800	
3-May-12	18.0	<1.72	421	1,900	
8-Feb-12	17.4	<2.17	442	1,960	
3-Nov-11	17.9	<2.17	442	960	
29-Jul-11	23.3	<2.17	449	2,000	
26-Apr-11	21.5	<2.17	446	1,900	
25-Jan-11	16.5	<2.17	446	1,940	
17-Sep-10	17.6	<10.0	439	1,880	
29-Jun-10	32	<1.0	520	2,070	
24-Mar-10	23.2	ND	620	1,960	
14-Dec-09	15.9	ND	600	1,924	
1-Sep-09	25.2	ND	540	1,964	
2-Jun-09	10.8	ND	560	2,068	
3-Mar-09	33.2	ND	535	2,038	

**TABLE 5. DISCHARGE PLAN MONITORING WELL GROUNDWATER ANALYTICAL RESULTS
DONA ANA DAIRIES, DONA ANA COUNTY, NEW MEXICO**

Monitoring Well	Date Sampled	Nitrate as N (mg/l)	TKN (mg/l)	Chloride (mg/l)	TDS (mg/l)
River Valley Dairy					
167-01	13-Aug-14	Not Sampled			
	23-May-14	Not Sampled			
	28-Feb-14	Not Sampled			
	10-Dec-13	Not Sampled			
	27-Aug-13	<0.164	10.5	290	1,260
	17-May-13	Not Sampled			
	20-Feb-13	Not Sampled			
	15-Nov-12	Not Sampled			
	14-Aug-12	Not Sampled			
	2-May-12	Not Sampled			
	30-Jan-12	Not Sampled			
	2-Nov-11	Not Sampled			
	25-Jul-11	Not Sampled			
	28-Apr-11	<0.500	3.92	720	2,960
	20-Jan-11	Not Sampled			
	27-Sep-10	1.55	9.94	731	2,540
	28-Jun-10	Not Sampled			
	5-Mar-10				
	15-Jan-10				
14-Sep-09					
2-Jun-09					
15-Mar-09					
167-01A	15-Nov-17	0.213	0.379	325	1,930
	16-Aug-17	0.510	<0.300	493	2,540
	23-May-17	0.223	0.680	519	2,540
	27-Feb-17	0.168	0.974	553	2,660
	15-Nov-16	1.18	<0.937	540	2,600
	30-Aug-16	0.386	<0.937	596	5,980
	24-May-16	0.933	<2.24	587	2,900
	17-Feb-16	<0.194	<1.18	703	2,960
	16-Nov-15	<0.194	<1.18	669	2,920
	24-Aug-15	0.216	<1.18	698	2,980
	20-May-15	1.18	<1.18	693	3,020
	16-Feb-15	1.18	<1.80	669	3,070
	20-Nov-14	1.65	19.6	539	3,260
	4-Sep-14	2.52	<1.80	652	3,070
	23-May-14	1.59	2.80	666	2,860
	28-Feb-14	2.03	<1.66	656	2,820
	10-Dec-13	2.35	2.80	643	2,720
	26-Aug-13	4.84	10.5	907	3,610
	17-May-13	4.83	<1.66	794	3,420
	20-Feb-13	1.10	<1.72	845	3,360
	15-Nov-12	4.02	<1.72	778	3,440
	14-Aug-12	1.78	4.20	888	3,260
	2-May-12	2.55	1.82	781	3,180
	30-Jan-12	2.54	3.50	755	2,940
	2-Nov-11	11.2	4.62	1,080	3,620
	25-Jul-11	2.13	3.92	943	3,330
	28-Apr-11	4.03	<2.17	1,030	3,710
	20-Jan-11	1.26	2.1	968	5,100
	22-Sep-10	1.40	3.36	1,010	3,470
	28-Jun-10	6.07	1.1	1,050	3,710
5-Mar-10	9.3	0.8	1,040	3,605	
15-Jan-10	5.3	0.5	1,090	3,590	
14-Sep-09	13.4	0.6	1,040	3,530	
2-Jun-09	13.7	0.7	980	3,505	
15-Mar-09	22.2	0.2	740	3,130	

**TABLE 5. DISCHARGE PLAN MONITORING WELL GROUNDWATER ANALYTICAL RESULTS
DONA ANA DAIRIES, DONA ANA COUNTY, NEW MEXICO**

Monitoring Well	Date Sampled	Nitrate as N (mg/l)	TKN (mg/l)	Chloride (mg/l)	TDS (mg/l)	
167-02	15-Nov-17	7.86	<0.300	818	2,460	
	16-Aug-17	7.76	<0.300	800	2,400	
	23-May-17	4.69	<0.0501	707	2,220	
	27-Feb-17	3.63	<0.300	701	2,280	
	15-Nov-16	2.32	<0.937	539	1,990	
	30-Aug-16	<0.305	<0.937	540	1,690	
	24-May-16	0.370	<2.24	521	1,680	
	17-Feb-16	<0.194	<1.18	486	1,560	
	16-Nov-15	Dry				
	24-Aug-15	Dry				
	20-May-15	Dry				
	16-Feb-15	0.878	<1.80	435	1,360	
	20-Nov-14	Dry				
	4-Sep-14	0.928	<1.80	455	1,580	
	18-Jun-14	Dry				
	28-Feb-14	Dry				
	10-Dec-13	Dry				
	23-Aug-13	Dry				
	17-May-13	Not Sampled				
	20-Feb-13	Not Sampled				
	15-Nov-12	Not Sampled				
	14-Aug-12	Not Sampled				
	30-Jan-12	Not Sampled				
	2-Nov-11	<0.500	3.64	432	650	
	25-Jul-11	Dry				
	28-Apr-11	<0.500	2.94	500	1,910	
	20-Jan-11	0.716	< 2.05	546	1,840	
	22-Sep-10	<0.846	<10.0	610	2,100	
	28-Jun-10	Not Sampled				
	5-Mar-10					
	15-Jan-10					
	14-Sep-09					
2-Jun-09						
28-Apr-08	7.0	0.3	780	2,580		

**TABLE 5. DISCHARGE PLAN MONITORING WELL GROUNDWATER ANALYTICAL RESULTS
DONA ANA DAIRIES, DONA ANA COUNTY, NEW MEXICO**

Monitoring Well	Date Sampled	Nitrate as N (mg/l)	TKN (mg/l)	Chloride (mg/l)	TDS (mg/l)
167-03	15-Nov-17	9.61	<0.300	445	1,680
	17-Aug-17	10.4	<0.300	456	1,830
	25-May-17	9.52	<0.300	431	1,820
	27-Feb-17	8.12	<0.300	428	1,880
	15-Nov-16	8.38	6.25	429	1,790
	31-Aug-16	9.94	<0.937	465	1,840
	25-May-16	10.8	<2.24	442	1,940
	17-Feb-16	10.5	<1.18	470	1,830
	16-Nov-15	12.7	1.68	497	2,000
	25-Aug-15	13.3	<1.18	496	2,020
	20-May-15	12.6	<1.18	478	1,940
	18-Feb-15	10.3	<1.80	429	1,940
	24-Nov-14	16.2	<1.80	529	2,080
	4-Sep-14	17.1	<1.80	534	2,220
	23-May-14	16.6	2.80	440	2,200
	28-Feb-14	15.4	<1.66	516	2,140
	10-Dec-13	17.6	<1.66	578	2,310
	26-Aug-13	19.0	2.80	587	2,440
	20-May-13	16.7	<1.66	543	2,140
	21-Feb-13	13.0	<1.72	500	1,950
	15-Nov-12	15.0	<1.72	503	2,150
	14-Aug-12	16.6	<1.72	500	2,350
	2-May-12	17.5	<1.72	499	2,220
	27-Jan-12	21.0	<2.17	572	2,250
	2-Nov-11	22.0	<2.17	564	2,150
	25-Jul-11	18.5	6.16	543	2,250
	28-Apr-11	17.1	<2.17	508	2,210
	20-Jan-11	13.2	2.24	467	1,880
	22-Sep-10	9.19	<10.0	472	2,120
	28-Jun-10	20.4	<5.0	567	2,310
5-Mar-10	18.4	<0.3	610	2,265	
15-Jan-10	13.7	0.6	620	2,015	
14-Sep-09	23.1	0.4	590	2,240	
2-Jun-09	25.0	0.5	680	2,515	
15-Mar-09	30.9	0.2	760	2,615	

**TABLE 5. DISCHARGE PLAN MONITORING WELL GROUNDWATER ANALYTICAL RESULTS
DONA ANA DAIRIES, DONA ANA COUNTY, NEW MEXICO**

Monitoring Well	Date Sampled	Nitrate as N (mg/l)	TKN (mg/l)	Chloride (mg/l)	TDS (mg/l)	
167-04	15-Nov-17	23.7	<0.300	982	3,280	
	17-Aug-17	26.3	<0.300	1,010	3,640	
	25-May-17	23.2	<0.300	956	3,490	
	27-Feb-17	24.0	<0.300	973	3,620	
	15-Nov-16	24.4	6.25	811	3,540	
	30-Aug-16	25.0	<0.937	1,020	3,560	
	24-May-16	25.9	<2.24	949	3,760	
	17-Feb-16	27.4	<1.18	998	3,740	
	16-Nov-15	27.2	1.68	952	3,410	
	25-Aug-15	27.0	<1.18	1,040	3,860	
	21-May-15	25.4	<1.18	1,050	3,740	
	18-Feb-15	27.7	<1.80	823	3,450	
	24-Nov-14	29.0	<1.80	908	3,520	
	4-Sep-14	25.1	<1.80	1,040	4,210	
	22-May-14	26.5	18.2	1,010	3,600	
	3-Mar-14	25.1	2.10	1,180	4,080	
	10-Dec-13	23.8	2.10	1,190	4,070	
	26-Aug-13	25.5	6.30	1,090	3,900	
	17-May-13	4.40	<1.66	796	4,170	
	20-Feb-13	21.9	<1.72	1,320	4,660	
	15-Nov-12	7.77	<1.72	1,150	4,380	
	14-Aug-12	23.2	2.10	1,110	4,540	
	2-May-12	18.6	13.6	1,050	4,020	
	27-Jan-12	15.6	3.50	1,500	4,840	
	2-Nov-11	Not Sampled - insufficient water to sample				
	26-Jul-11	19.3	4.62	1,270	4,560	
	28-Apr-11	7.95	73.1	1,610	4,960	
	20-Jan-11	Not Sampled				
	28-Jun-10					
	5-Mar-10					
	15-Jan-10					
	14-Sep-09	6.7	0.4	1,630	5,240	
	2-Jun-09	8.5	0.4	1,525	5,045	
	15-Mar-09	16.4	0.2	1,570	5,210	
167-05	15-Nov-17	2.56	0.573	852	3,190	
	17-Aug-17	3.61	<0.300	831	3,390	
	25-May-17	3.93	1.01	767	3,100	
	28-Feb-17	3.35	2.88	785	3,220	
	16-Nov-16	3.57	1.70	765	3,340	
	30-Aug-16	2.94	<0.937	806	3,400	
	24-May-16	5.43	<2.24	741	3,220	
	17-Feb-16	4.42	<1.18	732	2,960	
	13-Nov-15	4.28	4.48	763	3,140	
	25-Aug-15	3.40	2.10	756	3,100	
	21-May-15	6.62	1.40	688	2,880	
	19-Feb-15	4.97	<1.80	671	3,080	
	20-Nov-14	2.62	<1.80	747	3,360	
	3-Sep-14	4.16	<1.80	709	3,240	
	23-May-14	3.62	3.50	764	3,010	
	3-Mar-14	2.25	<1.66	818	3,180	
	10-Dec-13	1.58	3.50	886	3,290	
	26-Aug-13	4.54	3.50	767	3,400	
	17-May-13	23.3	<1.66	1,120	3,140	
	21-Feb-13	3.73	<1.72	842	3,360	
	19-Nov-12	2.31	<1.72	805	3,480	
	14-Aug-12	1.48	<1.72	1,630	3,220	
	2-May-12	3.50	2.24	777	3,180	
	30-Jan-12	4.40	<2.17	808	3,140	
	2-Nov-11	3.89	3.64	782	2,560	
	26-Jul-11	4.41	3.22	792	3,070	
	28-Apr-11	12.9	2.80	976	3,630	
	20-Jan-11	3.53	2.52	748	2,980	
	23-Sep-10	2.70	<10.0	758	2,820	
	28-Jun-10	4.07	<1.0	789	2,930	
5-Mar-10	2.9	<0.3	960	2,945		
15-Jan-10	1.8	<0.3	380	715		
14-Sep-09	1.9	0.4	890	2,970		
2-Jun-09	1.8	0.9	850	3,005		
15-Mar-09	4.6	0.2	910	3,230		

**TABLE 5. DISCHARGE PLAN MONITORING WELL GROUNDWATER ANALYTICAL RESULTS
DONA ANA DAIRIES, DONA ANA COUNTY, NEW MEXICO**

Monitoring Well	Date Sampled	Nitrate as N (mg/l)	TKN (mg/l)	Chloride (mg/l)	TDS (mg/l)
167-06	15-Nov-17	15.0	<0.300	565	2,230
	17-Aug-17	15.9	<0.300	589	2,220
	25-May-17	16.9	<0.300	570	2,330
	27-Feb-17	16.3	<0.300	571	2,330
	15-Nov-16	15.3	<0.937	354	2,310
	30-Aug-16	17.0	<0.937	608	2,380
	24-May-16	17.4	<2.24	607	2,440
	17-Feb-16	18.8	<1.18	633	2,400
	13-Nov-15	19.5	<1.18	650	2,550
	24-Aug-15	20.2	<1.18	642	2,620
	20-May-15	19.7	<1.18	649	2,490
	16-Feb-15	19.1	<1.80	591	2,580
	20-Nov-14	21.1	<1.80	702	2,900
	4-Sep-14	22.8	4.20	689	2,820
	22-May-14	22.8	4.20	726	2,660
	28-Feb-14	22.1	<1.66	707	2,620
	10-Dec-13	20.8	6.30	744	2,740
	26-Aug-13	29.0	2.10	757	2,740
	20-May-13	23.9	<1.66	704	2,620
	20-Feb-13	22.8	<1.72	725	2,660
	19-Nov-12	23.7	<1.72	718	2,980
	14-Aug-12	25.1	<1.72	677	2,910
	2-May-12	27.2	<1.72	688	2,480
	30-Jan-12	29.1	<2.17	754	2,880
	2-Nov-11	35.7	<2.17	716	3,390
	25-Jul-11	35.0	5.32	702	2,640
	28-Apr-11	35.4	<2.17	676	2,790
	20-Jan-11	29.6	2.38	634	2,560
	22-Sep-10	19.8	<10.0	655	2,630
	28-Jun-10	34.8	2.35	687	2,700
	5-Mar-10	30.9	<0.3	730	2,730
	15-Jan-10	26.2	0.4	750	2,755
14-Sep-09	40.4	<0.3	700	2,680	
2-Jun-09	31.5	0.4	790	2,715	
15-Mar-09	36.2	0.7	730	2,715	
167-07	15-Nov-17	0.114	<0.300	130	1,340
	17-Aug-17	0.119	<0.300	143	1,460
	23-May-17	0.120	<0.0501	140	1,210
	27-Feb-17	0.107	1.07	118	1,050
	15-Nov-16	1.26	<0.937	107	1,080
	30-Aug-16	<0.305	<0.937	123	1,370
	24-May-16	0.131	<2.24	93.6	1,460
	17-Feb-16	<0.0387	2.80	128	1,480
	13-Nov-15	<0.0387	<1.18	124	1,350
	24-Aug-15	<0.194	<1.18	542	4,990
	20-May-15	<0.0470	<1.18	206	1,540
	19-Feb-15	<0.0137	<1.80	196	1,600
	20-Nov-14	<0.126	<1.80	258	2,300
	4-Sep-14	<0.126	<1.80	609	5,680
	23-May-14	<0.187	<1.80	209	1,490
	28-Feb-14	<0.213	2.10	229	1,540
	10-Dec-13	0.960	6.30	233	1,770
	26-Aug-13	2.00	4.20	681	4,770
	17-May-13	<0.0420	<1.66	319	1,840
	20-Feb-13	<0.246	<1.72	446	3,640
	15-Nov-12	<0.0595	<1.72	498	3,280
	14-Aug-12	<0.114	4.06	1,160	6,090
	2-May-12	0.0285	<1.72	367	1,890
	30-Jan-12	<0.500	<2.17	411	1,850
	2-Nov-11	<0.500	<2.17	366	2,460
	25-Jul-11	<1.00	3.50	446	4,400
	28-Apr-11	<0.500	<2.17	292	1,750
	20-Jan-11	0.448	2.10	239	1,280
	22-Sep-10	0.0400	2.10	268	1,590
	28-Jun-10	<0.5	<2.0	287	1,600
	5-Mar-10	0.16	<0.3	370	1,650
	15-Jan-10	<0.03	<0.3	250	2,065
14-Sep-09	0.19	<0.3	390	1,700	
2-Jun-09	0.11	0.4	740	2,575	
15-Mar-09	0.11	0.2	1,090	3,165	

**TABLE 5. DISCHARGE PLAN MONITORING WELL GROUNDWATER ANALYTICAL RESULTS
DONA ANA DAIRIES, DONA ANA COUNTY, NEW MEXICO**

Monitoring Well	Date Sampled	Nitrate as N (mg/l)	TKN (mg/l)	Chloride (mg/l)	TDS (mg/l)
167-08	15-Nov-17	0.478	0.591	1,190	6,860
	17-Aug-17	1.28	<0.300	1,190	3,650
	25-May-17	0.277	0.587	1,070	3,570
	28-Feb-17	1.06	1.14	1,100	3,670
	16-Nov-16	0.903	<0.937	1,010	3,530
	31-Aug-16	<0.305	<0.937	1,000	3,300
	25-May-16	<0.305	<2.24	761	3,000
	17-Feb-16	<0.194	<1.18	1,050	3,480
	23-Nov-15	<0.194	<1.18	699	2,460
	25-Aug-15	Bailer Down Well -Not Sampled			
	21-May-15	<0.0470	<1.18	733	2,680
	24-Feb-15	<0.0137	2.10	729	2,960
	24-Nov-14	<0.126	<1.80	944	3,020
	4-Sep-14	<0.126	<1.80	726	2,840
	27-May-14	<0.187	2.10	777	2,920
	4-Mar-14	1.02	<1.66	884	3,090
	10-Dec-13	Not Sampled			
	27-Aug-13	Not Sampled			
	21-May-13	1.13	<1.66	723	2,820
	25-Feb-13	0.895	<1.72	827	2,640
	15-Nov-12	Well Damaged - Not Sampled			
	14-Aug-12	0.192	<1.72	788	2,860
	2-May-12	0.399	<1.72	744	2,580
	30-Jan-12	<0.500	<2.17	805	2,440
	2-Nov-11	1.93	<2.17	759	2,520
	26-Jul-11	3.77	4.20	779	3,030
	28-Apr-11	3.74	<2.17	793	2,740
	20-Jan-11	<0.239	2.10	764	2,640
	23-Sep-10	0.250	<10.0	756	2,720
	28-Jun-10	5.51	<0.5	804	2,990
	5-Mar-10	5.5	<0.3	830	2,750
	15-Jan-10	0.84	<0.3	720	2,530
	14-Sep-09	2.9	0.3	640	2,380
	2-Jun-09	2.1	0.6	750	2,785
15-Mar-09	3.2	0.2	740	2,710	
167-09	15-Nov-17	0.289	0.631	1,050	2,510
	17-Aug-17	0.561	<0.300	874	2,940
	25-May-17	0.819	<0.300	748	2,830
	27-Feb-17	0.722	1.00	631	2,540
	15-Nov-16	0.991	<0.937	491	2,620
	30-Aug-16	<0.305	<0.937	670	2,680
	24-May-16	1.54	<2.24	631	2,570
	17-Feb-16	<0.194	<1.18	576	2,500
	13-Nov-15	<0.194	<1.18	627	2,400
	25-Aug-15	2.30	1.40	563	2,480
	21-May-15	4.15	<1.18	602	2,440
	19-Feb-15	5.42	<1.80	719	2,710
	20-Nov-14	6.31	2.80	683	2,830
	3-Sep-14	10.5	<1.80	680	2,980
	23-May-14	10.1	3.50	721	2,800
	3-Mar-14	6.49	<1.66	756	2,840
	10-Dec-13	3.82	4.90	777	2,980
	27-Aug-13	6.24	5.60	772	3,320
	17-May-13	10.7	<1.66	726	3,050
	21-Feb-13	4.51	<1.72	959	3,580
	19-Nov-12	12.8	<1.72	979	3,560
	14-Aug-12	8.47	2.10	916	3,760
	2-May-12	14.5	<1.72	1,070	4,000
	30-Jan-12	13.2	2.80	1,010	3,590
	3-Nov-11	7.53	8.40	988	3,590
	26-Jul-11	<1.00	3.78	736	2,300
	28-Apr-11	<0.500	2.38	467	2,140
	20-Jan-11	0.0147	<2.05	429	2,160
	24-Sep-10	0.0300	<10.0	432	1,500
	28-Jun-10	<0.5	<1.0	491	2,160
	5-Mar-10	0.05	<0.3	580	2,150
	15-Jan-10	<0.03	<0.3	500	2,250
	14-Sep-09	<0.03	<0.3	530	2,055
	2-Jun-09	0.04	0.7	540	2,205
15-Mar-09	0.07	0.2	630	2,400	

**TABLE 5. DISCHARGE PLAN MONITORING WELL GROUNDWATER ANALYTICAL RESULTS
DONA ANA DAIRIES, DONA ANA COUNTY, NEW MEXICO**

Monitoring Well	Date Sampled	Nitrate as N (mg/l)	TKN (mg/l)	Chloride (mg/l)	TDS (mg/l)	
Big Sky Dairy						
833-01	5-Aug-17	Plugged and Abandoned				
	31-May-17	Dry				
	1-Mar-17	Dry				
	17-Nov-16	Dry				
	29-Aug-16	Dry				
	27-May-16	Dry				
	22-Feb-16	Dry				
	18-Nov-15	Dry				
	27-Aug-15	Dry				
	21-May-15	Dry				
	25-Feb-15	Dry				
	25-Nov-14	Dry				
	25-Aug-14	Dry				
	27-May-14	Dry				
	4-Mar-14	Dry				
	6-Nov-13	Dry				
	29-Aug-13	Dry				
	21-May-13	Dry				
	26-Feb-13	Dry				
	19-Nov-12	Dry				
	15-Aug-12	Dry				
	7-May-12	Dry				
	15-Feb-12	Dry				
	1-Nov-11	Dry				
	21-Jul-11	Dry				
	29-Apr-11	Not Sampled - insufficient water to sample				
	24-Jan-11	33.6	4.20	997	3,100	
	23-Sep-10	29.1	<10.0	881	3,300	
	28-Jun-10	1.7	1.8	180	790	
	23-Mar-10	28.3	0.7	1,025	2,640	
14-Dec-09	21.8	ND	975	2,800		
31-Aug-09	15.3	ND	999	2,894		
1-Jun-09	8.6	ND	1,030	2,382		
2-Mar-09	37.1	ND	1,070	3,750		

**TABLE 5. DISCHARGE PLAN MONITORING WELL GROUNDWATER ANALYTICAL RESULTS
DONA ANA DAIRIES, DONA ANA COUNTY, NEW MEXICO**

Monitoring Well	Date Sampled	Nitrate as N (mg/l)	TKN (mg/l)	Chloride (mg/l)	TDS (mg/l)
833-02	20-Nov-23	35	<0.50	1,400	4,080
	22-Aug-23	40	<5.0	1,400	3,990
	16-May-23	37	<5.0	1,300	3,760
	22-Feb-23	33	<5.0	1,400	3,690
	17-Nov-22	72	<5.0	930	3,280
	17-Aug-22	89	<5.0	810	3,030
	18-May-22	36	<5.0	1,400	4,030
	24-Feb-22	53	<5.0	1,200	3,580
	16-Nov-21	41	<5.0	1,300	3,920
	17-Aug-21	80	<5.0	1,300	4,100
	18-May-21	67	<5.0	1,400	4,280
	24-Feb-21	59	<5.0	1,300	3,920
	18-Nov-20	89	<5.0	1,100	3,960
	24-Aug-20	88	<5.0	1,000	3,300
	20-May-20	81	<5.0	950	3,180
	17-Feb-20	63	<5.0	1,200	3,790
	21-Nov-19	100	<5.0	1,000	3,520
	14-Aug-19	65	<5.0	1,400	4,240
	22-May-19	68	<5.0	1,400	4,230
	4-Mar-19	66	<5.0	1,300	4,180
	26-Nov-18	62	<5.0	1,300	4,240
	31-Aug-18	67	<5.0	1,300	4,190
	29-May-18	63	<5.0	1,300	4,210
	21-Feb-18	65	<5.0	1,200	4,240
	16-Nov-17	66.4	<0.0500	1,300	3,730
	1-Sep-17	90.2	<0.0500	977	3,140
	30-May-17	71.2	<0.0501	1,340	4,380
	28-Feb-17	62.3	<0.300	1,240	4,290
	18-Nov-16	68.5	<0.937	1,340	4,210
	29-Aug-16	69.5	<0.937	1,360	4,360
	31-May-16	79.9	<2.24	1,400	4,440
	22-Feb-16	48.0	<1.18	796	2,400
	18-Nov-15	74.5	4.48	1,300	4,240
	27-Aug-15	44.5	2.80	720	2,250
	22-May-15	34.5	<1.18	702	2,140
	25-Feb-15	50.9	<1.80	780	2,820
	25-Nov-14	60.4	<1.80	1,010	3,480
	25-Aug-14	24.8	<1.80	528	2,090
	27-May-14	27.0	2.10	563	2,140
	5-Mar-14	79.8	<1.66	1,120	3,920
	20-Nov-13	65.4	2.10	884	3,060
	5-Sep-13	85.8	69.3	1,080	4,270
	21-May-13	69.2	<1.66	858	3,140
	25-Feb-13	97.0	<1.72	1,110	3,820
	19-Nov-12	84.3	2.10	1,030	4,020
	15-Aug-12	37.5	2.94	535	2,440
	7-May-12	43.3	65.1	635	2,420
	15-Feb-12	87.2	4.34	889	3,660
	1-Nov-11	82.3	2.38	885	4,010
	21-Jul-11	91.6	3.08	880	3,510
	29-Apr-11	81.6	6.02	840	3,500
	24-Jan-11	69.3	2.66	789	3,090
	23-Sep-10	52.9	<10.0	833	3,650
	28-Jun-10	29	<5.0	560	2,200
	23-Mar-10	15.9	ND	660	2,066
	14-Dec-09	11.5	0.28	650	2,018
	31-Aug-09	12.4	ND	660	2,170
	1-Jun-09	<0.5	ND	650	3,358
	2-Mar-09	3.54	13.44	585	1,978

**TABLE 5. DISCHARGE PLAN MONITORING WELL GROUNDWATER ANALYTICAL RESULTS
DONA ANA DAIRIES, DONA ANA COUNTY, NEW MEXICO**

Monitoring Well	Date Sampled	Nitrate as N (mg/l)	TKN (mg/l)	Chloride (mg/l)	TDS (mg/l)
833-03	5-Aug-17	Plugged and Abandoned			
	30-May-17	Dry			
	1-Mar-17	Dry			
	17-Nov-16	Dry			
	29-Aug-16	Dry			
	27-May-16	Dry			
	22-Feb-16	Dry			
	18-Nov-15	Dry			
	27-Aug-15	Dry			
	21-May-15	Dry			
	25-Feb-15	Dry			
	24-Nov-14	Dry			
	25-Aug-14	Dry			
	27-May-14	Dry			
	3-Mar-14	Dry			
	6-Nov-13	Dry			
	29-Aug-13	Dry			
	21-May-13	Dry			
	25-Feb-13	Dry			
	19-Nov-12	Dry			
	15-Aug-12	Dry			
	3-May-12	Dry			
	15-Feb-12	Dry			
	1-Nov-11	Dry			
	21-Jul-11	Dry			
	4-May-11	24.8	4.20	1,660	4,120
	24-Jan-11	30.4	2.66	1,650	4,090
	23-Sep-10	18.1	<10.0	1,410	3,880
	28-Jun-10	5.0	5.5	650	1,870
	23-Mar-10	14.0	ND	1,750	4,044
14-Dec-09	11.8	0.28	1,839	4,280	
31-Aug-09	8.9	ND	1,760	4,216	
1-Jun-09	90.4	ND	1,620	3,060	
2-Mar-09	21.2	ND	1,580	3,970	

**TABLE 5. DISCHARGE PLAN MONITORING WELL GROUNDWATER ANALYTICAL RESULTS
DONA ANA DAIRIES, DONA ANA COUNTY, NEW MEXICO**

Monitoring Well	Date Sampled	Nitrate as N (mg/l)	TKN (mg/l)	Chloride (mg/l)	TDS (mg/l)
833-04	20-Nov-23	35	<0.50	930	3,060
	22-Aug-23	37	<5.0	900	2,970
	16-May-23	29	<5.0	790	2,650
	21-Feb-23	37	<5.0	900	2,960
	17-Nov-22	35	<5.0	820	2,870
	17-Aug-22	21	<5.0	650	2,390
	16-May-22	36	<5.0	950	3,000
	24-Feb-22	29	<5.0	890	2,860
	15-Nov-21	24	<5.0	940	2,830
	17-Aug-21	32	<5.0	830	2,770
	17-May-21	20	<5.0	680	2,410
	23-Feb-21	21	<5.0	740	2,350
	18-Nov-20	22	<5.0	620	2,510
	24-Aug-20	18	<2.0	690	2,240
	20-May-20	18	<2.0	670	2,290
	17-Feb-20	20	<5.0	720	2,450
	20-Nov-19	31	<5.0	840	2,800
	15-Aug-19	40	<1.0	980	3,170
	23-May-19	29	<5.0	800	2,800
	4-Mar-19	31	<5.0	830	2,900
	26-Nov-18	42	<5.0	950	3,230
	4-Sep-18	40	<5.0	960	3,190
	24-May-18	34	<5.0	910	3,010
	20-Feb-18	20	<5.0	680	2,390
	20-Nov-17	32.6	<0.300	902	2,930
	31-Aug-17	37.3	<0.0500	797	2,640
	30-May-17	32.0	<0.0501	880	3,000
	1-Mar-17	31.5	<0.300	866	3,080
	18-Nov-16	39.8	<0.937	586	3,300
	29-Aug-16	40.6	<0.937	977	3,160
	27-May-16	21.6	<2.24	781	2,660
	22-Feb-16	12.7	<1.18	746	2,130
	19-Nov-15	11.8	3.36	762	2,310
	27-Aug-15	26.2	<1.18	835	2,580
	22-May-15	15.6	<1.18	766	2,290
	25-Feb-15	15.5	<1.80	666	2,260
	25-Nov-14	46.6	<1.80	914	3,280
	22-Aug-14	10.4	<1.80	677	2,230
	29-May-14	23.5	5.60	780	2,670
	4-Mar-14	50.0	<1.66	1,010	3,530
20-Nov-13	12.8	2.10	711	2,280	
30-Aug-13	37.9	2.80	868	3,260	
21-May-13	41.9	<1.66	875	3,180	
25-Feb-13	2.45	<1.72	1,050	3,600	
19-Nov-12	50.0	<1.72	1,010	3,770	
15-Aug-12	32.7	2.66	783	2,680	
3-May-12	24.1	<1.72	623	2,920	
15-Feb-12	49.9	<2.17	942	3,320	
1-Nov-11	43.4	<2.17	867	3,040	
21-Jul-11	45.3	2.52	883	3,410	
29-Apr-11	46.2	<2.17	902	3,280	
24-Jan-11	40.9	<2.05	755	3,040	
24-Sep-10	<50.0	<10.0	915	3,480	
28-Jun-10	18	<2.0	500	1,830	
23-Mar-10	11.3	ND	560	1,648	
14-Dec-09	11.2	0.42	570	1,750	
31-Aug-09	16.1	ND	630	1,986	
1-Jun-09	3.03	ND	580	1,968	
2-Mar-09	14.6	ND	600	1,884	

**TABLE 5. DISCHARGE PLAN MONITORING WELL GROUNDWATER ANALYTICAL RESULTS
DONA ANA DAIRIES, DONA ANA COUNTY, NEW MEXICO**

Monitoring Well	Date Sampled	Nitrate as N (mg/l)	TKN (mg/l)	Chloride (mg/l)	TDS (mg/l)
833-05	21-Nov-23	21	<0.50	1,000	3,000
	23-Aug-23	22	<5.0	1,000	2,960
	3-Jul-23	24	<5.0	1,000	3,120
	23-Feb-23	30	<5.0	1,300	3,300
	21-Nov-22	28	<5.0	1,100	3,190
	18-Aug-22	26	<5.0	1,200	3,560
	18-May-22	32	<5.0	1,200	3,500
	10-Mar-22	45	<5.0	1,200	3,490
	16-Nov-21	41	<5.0	1,200	3,510
	17-Aug-21	34	<2.0	1,300	3,490
	19-May-21	32	<5.0	1,100	3,460
	25-Feb-21	45	<5.0	1,300	3,460
	19-Nov-20	46	<5.0	1,200	3,460
	25-Aug-20	44	<5.0	1,300	3,550
	19-May-20	19	<2.0	1,100	3,180
	17-Feb-20	46	<5.0	1,300	3,620
	20-Nov-19	35	<5.0	1,300	3,500
	15-Aug-19	41	<1.0	1,300	3,600
	22-May-19	29	<5.0	1,300	3,430
	5-Mar-19	46	<5.0	1,200	3,520
	26-Nov-18	45	<5.0	1,200	3,530
	31-Aug-18	35	<5.0	1,300	3,530
	24-May-18	46	<5.0	1,100	3,350
	22-Feb-18	42	<5.0	1,200	3,530
	17-Nov-17	51.7	<0.0500	931	3,330
	31-Aug-17	42.5	<0.0500	1,220	3,350
	31-May-17	25.9	<0.0501	1,260	3,540
	1-Mar-17	20.9	<0.300	1,290	3,320
	17-Nov-16	22.4	<0.937	1,330	3,560
	29-Aug-16	21.9	<0.937	1,230	3,560
	26-May-16	20.7	<2.24	1,080	3,120
	19-Feb-16	22.3	<1.18	1,190	3,080
	18-Nov-15	20.9	<1.18	958	2,720
	27-Aug-15	22.1	2.80	833	2,350
	22-May-15	19.7	<1.18	999	2,680
	26-Feb-15	18.7	<1.80	1,050	2,970
	24-Nov-14	19.8	<1.80	992	2,680
	21-Aug-14	21.0	<1.80	752	2,320
	29-May-14	15.6	4.20	1,070	3,130
	4-Mar-14	18.5	<1.66	1,170	3,170
25-Nov-13	17.8	2.80	1,060	2,900	
29-Aug-13	20.9	20.3	911	2,660	
21-May-13	14.7	<1.66	1,070	2,920	
26-Feb-13	16.8	<1.72	1,270	3,140	
20-Nov-12	15.0	2.10	1,070	3,100	
15-Aug-12	13.9	<1.72	1,100	3,250	
3-May-12	12.8	<1.72	1,030	2,790	
15-Feb-12	14.9	<2.17	1,230	3,100	
1-Nov-11	12.2	2.24	1,150	2,580	
21-Jul-11	12.0	2.66	1,210	3,180	
29-Apr-11	17.6	<2.17	1,330	3,300	
24-Jan-11	23.2	2.66	1,340	3,430	
24-Sep-10	28.9	<10.0	1,330	3,800	
28-Jun-10	12	<2.0	1,200	3,090	
23-Mar-10	12.2	ND	1,240	2,942	
14-Dec-09	6.7	0.56	1,280	3,096	
31-Aug-09	9.0	ND	1,220	3,152	
1-Jun-09	3.43	ND	1,230	3,026	
2-Mar-09	11	ND	1,255	3,134	

**TABLE 5. DISCHARGE PLAN MONITORING WELL GROUNDWATER ANALYTICAL RESULTS
DONA ANA DAIRIES, DONA ANA COUNTY, NEW MEXICO**

Monitoring Well	Date Sampled	Nitrate as N (mg/l)	TKN (mg/l)	Chloride (mg/l)	TDS (mg/l)
833-06	20-Nov-23	15	<0.50	770	2,350
	21-Aug-23	14	<2.0	790	2,500
	15-May-23	44	<5.0	820	2,740
	21-Feb-23	14	<2.0	890	2,700
	17-Nov-22	38	<5.0	850	2,610
	17-Aug-22	55	<5.0	770	2,860
	16-May-22	44	<5.0	890	2,840
	23-Feb-22	14	<2.0	880	2,560
	15-Nov-21	50	<5.0	820	2,850
	17-Aug-21	46	<5.0	860	2,680
	18-May-21	46	<5.0	800	2,820
	23-Feb-21	23	<5.0	920	2,630
	18-Nov-20	53	<5.0	760	2,800
	24-Aug-20	70	<5.0	900	2,790
	19-May-20	44	<5.0	820	2,790
	17-Feb-20	19	<2.0	870	2,700
	20-Nov-19	43	<5.0	810	2,660
	15-Aug-19	47	<1.0	880	2,760
	23-May-19	47	<5.0	840	2,740
	5-Mar-19	47	<5.0	780	2,710
	27-Nov-18	24	<5.0	820	2,660
	4-Sep-18	16	<2.0	670	2,260
	29-May-18	11	<2.0	740	2,260
	22-Feb-18	15	<2.0	820	2,500
	16-Nov-17	16.9	<0.0500	786	2,300
	1-Sep-17	18.5	<0.0500	803	2,470
	31-May-17	39.9	<0.0501	800	2,560
	1-Mar-17	40.4	<0.300	792	2,740
	17-Nov-16	43.2	3.41	809	2,680
	26-Aug-16	32.7	<0.937	660	2,640
	27-May-16	28.8	<2.24	711	2,380
	22-Feb-16	22.0	<1.18	706	2,300
	19-Nov-15	51.1	<1.18	752	2,560
	27-Aug-15	32.3	<1.18	708	2,360
	22-May-15	38.6	<1.18	787	2,470
	24-Feb-15	71.9	<1.80	827	3,080
	25-Nov-14	46.5	<1.80	836	2,710
	21-Aug-14	17.4	<1.80	663	2,300
	29-May-14	26.5	3.50	760	2,460
	4-Mar-14	41.9	<1.66	847	2,800
21-Nov-13	27.4	3.50	771	2,490	
30-Aug-13	25.3	2.80	656	2,310	
20-May-13	25.9	<1.66	816	2,640	
25-Feb-13	21.6	<1.72	924	2,750	
19-Nov-12	24.2	<1.72	920	2,840	
15-Aug-12	23.4	<1.72	845	2,670	
3-May-12	20.7	<1.72	702	2,560	
14-Feb-12	26.4	<2.17	727	2,480	
2-Nov-11	28.8	3.08	688	1,900	
21-Jul-11	70.1	7.70	682	2,650	
4-May-11	36.4	7.70	717	2,440	
20-Jan-11	61.0	2.80	738	2,360	
23-Sep-10	64.3	<10.0	761	2,680	
28-Jun-10	23	<5.0	630	2,310	
23-Mar-10	24.8	2.38	700	2,184	
14-Dec-09	22.7	1.68	820	2,344	
31-Aug-09	25.1	1.96	790	2,708	
1-Jun-09	106	ND	680	2,280	
2-Mar-09	66.4	ND	610	2,160	

**TABLE 5. DISCHARGE PLAN MONITORING WELL GROUNDWATER ANALYTICAL RESULTS
DONA ANA DAIRIES, DONA ANA COUNTY, NEW MEXICO**

Monitoring Well	Date Sampled	Nitrate as N (mg/l)	TKN (mg/l)	Chloride (mg/l)	TDS (mg/l)
833-07	21-Nov-23	77	<0.50	1,300	4,020
	23-Aug-23	96	<5.0	1,400	4,620
	16-May-23	92	<5.0	1,300	4,450
	22-Feb-23	70	<5.0	1,200	3,730
	18-Nov-22	63	<5.0	1,200	3,950
	18-Aug-22	91	<5.0	1,200	4,420
	18-May-22	92	<5.0	1,100	4,170
	10-Mar-22	66	<1.0	1,100	3,580
	16-Nov-21	67	<5.0	1,000	3,790
	18-Aug-21	70	<5.0	1,100	3,700
	18-May-21	65	<5.0	1,000	3,680
	24-Feb-21	62	<5.0	1,000	3,430
	19-Nov-20	62	<5.0	970	3,670
	25-Aug-20	68	<5.0	1,100	3,750
	19-May-20	67	<5.0	1,000	3,830
	17-Feb-20	68	<5.0	1,100	3,440
	20-Nov-19	74	<5.0	1,100	3,680
	15-Aug-19	74	<1.0	1,100	3,630
	22-May-19	69	<5.0	1,100	3,760
	4-Mar-19	65	<5.0	1,100	3,680
	26-Nov-18	70	<5.0	1,100	3,630
	31-Aug-18	74	<5.0	1,100	3,800
	24-May-18	74	<5.0	1,000	3,670
	22-Feb-18	63	<5.0	1,000	3,760
	17-Nov-17	68.2	<0.0500	808	3,540
	31-Aug-17	78.7	<0.0500	1,050	3,630
	30-May-17	83.3	<0.0501	1,120	4,080
	1-Mar-17	78.0	<0.300	1,140	3,990
	17-Nov-16	85.3	2.27	1,180	4,180
	29-Aug-16	92.2	<0.937	1,230	5,970
	27-May-16	100	<2.24	1,230	4,620
	18-Feb-16	97.4	<1.18	1,260	4,540
	18-Nov-15	91.0	1.68	1,130	4,150
	27-Aug-15	88.9	2.80	1,350	4,700
	22-May-15	76.7	<1.18	1,320	4,460
	25-Feb-15	86.8	<1.80	1,100	4,320
	24-Nov-14	92.5	<1.80	1,190	4,300
	21-Aug-14	83.6	5.60	1,360	4,920
	29-May-14	87.0	4.90	1,380	4,760
	4-Mar-14	73.0	<1.66	1,390	4,420
	21-Nov-13	78.3	2.80	1,330	4,380
	29-Aug-13	78.4	4.90	1,330	4,420
	21-May-13	88.7	<1.66	1,400	4,730
	26-Feb-13	95.5	<1.72	1,470	4,500
	20-Nov-12	95.1	<1.72	1,130	4,290
15-Aug-12	99.8	2.52	1,540	5,110	
7-May-12	95.6	7.56	1,460	4,880	
15-Feb-12	90.3	<2.17	1,340	4,660	
1-Nov-11	94.2	<2.17	1,090	3,840	
21-Jul-11	105	<2.17	115	4,090	
29-Apr-11	100	<2.17	1,220	4,380	
24-Jan-11	100	2.10	1,140	4,350	
24-Sep-10	129	<10.0	933	3,800	
28-Jun-10	69	<5.0	1,300	4,160	
23-Mar-10	106	ND	1,320	3,884	
14-Dec-09	101	0.42	1,260	3,988	
31-Aug-09	74	8.68	1,180	3,978	
1-Jun-09	12.4	8.68	1,180	3,964	
2-Mar-09	33.2	ND	1,380	3,866	

**TABLE 5. DISCHARGE PLAN MONITORING WELL GROUNDWATER ANALYTICAL RESULTS
DONA ANA DAIRIES, DONA ANA COUNTY, NEW MEXICO**

Monitoring Well	Date Sampled	Nitrate as N (mg/l)	TKN (mg/l)	Chloride (mg/l)	TDS (mg/l)
833-08	21-Nov-23	67	<0.50	1,100	3,460
	22-Aug-23	67	<5.0	1,000	3,300
	16-May-23	49	<5.0	1,100	3,210
	22-Feb-23	30	<5.0	1,300	3,160
	18-Nov-22	25	<5.0	1,100	2,990
	18-Aug-22	47	<5.0	1,200	3,650
	18-May-22	45	<5.0	1,200	3,740
	10-Mar-22	45	<5.0	1,600	4,200
	16-Nov-21	46	<5.0	1,100	3,590
	18-Aug-21	11	<2.0	730	2,360
	18-May-21	35	<5.0	1,200	3,540
	24-Feb-21	36	<5.0	1,300	4,010
	18-Nov-20	32	<5.0	850	3,450
	24-Aug-20	21	<5.0	880	2,650
	19-May-20	38	<5.0	820	2,860
	17-Feb-20	49	<5.0	990	3,110
	20-Nov-19	43	<5.0	850	2,930
	14-Aug-19	46	<1.0	880	3,010
	23-May-19	43	<5.0	900	2,980
	5-Mar-19	48	<5.0	890	3,040
	27-Nov-18	47	<5.0	860	2,950
	4-Sep-18	46	<5.0	830	2,820
	24-May-18	52	<5.0	840	2,980
	22-Feb-18	48	<5.0	890	3,030
	17-Nov-17	54.3	<0.0500	631	2,970
	1-Sep-17	52.3	<0.0500	917	3,250
	31-May-17	67.6	<0.0501	984	3,230
	1-Mar-17	70.3	<0.300	960	3,350
	18-Nov-16	48.3	<0.937	1,020	3,720
	29-Aug-16	25.6	<0.937	1,150	3,310
	27-May-16	46.5	5.19	1,010	3,080
	19-Feb-16	52.9	<1.18	1,140	3,020
	18-Nov-15	56.9	<1.18	533	2,010
	27-Aug-15	55.7	<1.18	569	2,360
	21-May-15	66.4	<1.18	620	2,460
	26-Feb-15	65.1	<1.80	981	3,340
	24-Nov-14	63.7	<1.80	1,130	3,320
	22-Aug-14	90.2	<1.80	672	2,900
	27-May-14	91.5	2.10	772	3,030
	4-Mar-14	100	<1.66	807	3,220
21-Nov-13	86.3	<1.66	827	3,000	
29-Aug-13	79.6	4.90	971	3,300	
21-May-13	80.2	<1.66	953	3,320	
26-Feb-13	83.1	<1.72	877	2,940	
20-Nov-12	60.8	<1.72	1,070	3,580	
15-Aug-12	57.8	2.52	987	3,480	
3-May-12	61.4	<1.72	927	3,040	
15-Feb-12	77.6	<2.17	1,020	3,200	
1-Nov-11	69.8	4.20	966	3,080	
21-Jul-11	68.8	<2.17	963	3,240	
29-Apr-11	75.9	<2.17	950	3,330	
24-Jan-11	93.4	2.10	930	3,190	
23-Sep-10	91.8	<10.0	985	3,600	
28-Jun-10	35	<5.0	630	2,290	
23-Mar-10	33	ND	700	2,108	
14-Dec-09	31	ND	950	2,710	
31-Aug-09	63	ND	1,020	3,576	
1-Jun-09	41.4	ND	1,000	3,492	
2-Mar-09	121	ND	700	2,038	

**TABLE 5. DISCHARGE PLAN MONITORING WELL GROUNDWATER ANALYTICAL RESULTS
DONA ANA DAIRIES, DONA ANA COUNTY, NEW MEXICO**

Monitoring Well	Date Sampled	Nitrate as N (mg/l)	TKN (mg/l)	Chloride (mg/l)	TDS (mg/l)
833-09	27-Nov-23	64	<0.50	830	3,500
	23-Aug-23	64	<5.0	780	3,560
	17-May-23	110	<5.0	850	4,100
	23-Feb-23	100	<5.0	850	4,160
	21-Nov-22	130	<5.0	840	4,260
	18-Aug-22	190	<5.0	980	5,040
	19-May-22	190	<5.0	1,000	4,700
	10-Mar-22	120	<1.0	910	4,160
	17-Nov-21	110	<5.0	800	3,990
	18-Aug-21	150	<5.0	1,100	4,340
	19-May-21	19	<2.0	690	2,760
	25-Feb-21	21	<5.0	750	2,740
	19-Nov-20	21	<2.0	800	2,750
	25-Aug-20	24	<5.0	790	2,970
	19-May-20	23	8.4	760	2,870
	18-Feb-20	36	<5.0	800	3,100
	21-Nov-19	33	<5.0	750	3,110
	14-Aug-19	32	<5.0	790	3,030
	22-May-19	26	<5.0	790	2,930
	4-Mar-19	45	<5.0	760	3,130
	26-Nov-18	42	<5.0	790	3,140
	4-Sep-18	43	<5.0	810	3,140
	24-May-18	43	<5.0	770	3,110
	21-Feb-18	55	<5.0	730	3,200
	16-Nov-17	59.0	<0.0500	1,190	2,740
	31-Aug-17	51.5	<0.0500	701	3,190
	30-May-17	59.2	<0.0501	799	3,410
	28-Feb-17	65.6	<0.300	779	3,440
	17-Nov-16	64.9	2.27	763	3,410
	26-Aug-16	63.3	<0.937	793	3,440
	26-May-16	71.8	<2.24	726	3,510
	19-Feb-16	112	<1.18	942	3,880
	18-Nov-15	109	<1.18	902	3,860
	27-Aug-15	92.6	<1.18	861	3,580
	21-May-15	123	<1.18	957	4,170
	25-Feb-15	136	<1.80	936	4,450
	25-Nov-14	137	<1.80	965	4,260
	22-Aug-14	64.9	<1.80	759	3,240
	27-May-14	85.0	6.30	868	3,790
	5-Mar-14	125	<1.66	998	4,430
20-Nov-13	137	<1.66	1,060	4,640	
29-Aug-13	82.2	3.50	786	3,860	
22-May-13	78.1	<1.66	786	3,630	
28-Feb-13	101	<1.72	876	4,060	
20-Nov-12	89.6	<1.72	731	3,760	
15-Aug-12	99.3	<1.72	875	3,780	
7-May-12	80.4	<1.72	745	3,830	
15-Feb-12	94.8	<2.17	725	3,580	
1-Nov-11	93.0	<2.17	779	3,880	
21-Jul-11	135	<2.17	1,070	4,550	
4-May-11	147	<2.17	1,420	5,540	
25-Jan-11	134	2.80	1,420	4,850	
24-Sep-10	58.2	<10.0	1,050	4,110	
28-Jun-10	50	<5.0	1,200	4,380	
23-Mar-10	16.3	0.56	1,100	3,624	
14-Dec-09	2.7	0.28	960	3,184	
31-Aug-09	6.6	ND	870	3,178	
1-Jun-09	18.1	1.12	880	3,164	
2-Mar-09	7.07	ND	825	3,202	

**TABLE 5. DISCHARGE PLAN MONITORING WELL GROUNDWATER ANALYTICAL RESULTS
DONA ANA DAIRIES, DONA ANA COUNTY, NEW MEXICO**

Monitoring Well	Date Sampled	Nitrate as N (mg/l)	TKN (mg/l)	Chloride (mg/l)	TDS (mg/l)
833-10	27-Nov-23	3.2	0.92	710	2,770
	24-Aug-23	3.4	1.3	680	2,740
	17-May-23	2.2	<1.0	700	2,790
	23-Feb-23	1.5	<1.0	730	2,790
	21-Nov-22	1.6	1.1	680	2,830
	19-Aug-22	1.7	1.3	730	2,830
	19-May-22	1.5	<1.0	740	2,870
	28-Feb-22	1.0	1.1	890	2,830
	17-Nov-21	1.2	<1.0	750	2,800
	18-Aug-21	1.3	<1.0	730	2,750
	19-May-21	<1.0	1.1	700	2,750
	25-Feb-21	<1.0	<1.0	710	2,590
	19-Nov-20	<1.0	<1.0	730	2,650
	25-Aug-20	<1.0	1.1	710	2,710
	20-May-20	<1.0	2.2	700	2,690
	18-Feb-20	<1.0	1.1	680	2,630
	21-Nov-19	1.5	<1.0	630	2,630
	14-Aug-19	2.0	<1.0	660	2,560
	22-May-19	1.8	<1.0	640	2,560
	4-Mar-19	1.8	<1.0	580	2,520
	26-Nov-18	2.6	<1.0	620	2,520
	31-Aug-18	3.3	<1.0	600	2,540
	24-May-18	3.6	<1.0	610	2,510
	22-Feb-18	3.5	<1.0	630	2,480
	16-Nov-17	5.74	0.862	613	2,060
	31-Aug-17	6.75	0.299	606	2,430
	30-May-17	3.83	0.927	650	2,560
	1-Mar-17	3.90	0.396	639	2,670
	17-Nov-16	4.64	<0.937	534	2,620
	26-Aug-16	4.38	<0.937	677	2,660
	26-May-16	4.22	<2.24	637	2,680
	19-Feb-16	2.50	<1.18	691	2,550
	18-Nov-15	2.69	<1.18	660	2,580
	27-Aug-15	3.58	<1.18	678	2,670
	21-May-15	3.81	<1.18	732	2,700
	25-Feb-15	4.52	<1.80	661	2,740
	25-Nov-14	4.96	<1.80	690	2,760
	21-Aug-14	5.66	<1.80	671	2,780
	29-May-14	3.20	2.10	667	2,670
	5-Mar-14	2.47	<1.66	679	2,660
20-Nov-13	2.93	<1.66	695	2,620	
29-Aug-13	3.77	4.20	642	2,800	
22-May-13	3.96	<1.66	648	2,580	
28-Feb-13	4.19	<1.72	689	2,640	
20-Nov-12	4.25	<1.72	608	2,540	
15-Aug-12	4.93	2.52	585	2,530	
7-May-12	3.95	<1.72	581	2,350	
15-Feb-12	3.18	<2.17	582	2,440	
1-Nov-11	3.69	<2.17	573	2,590	
21-Jul-11	4.63	3.78	597	2,480	
4-May-11	5.19	<2.17	714	2,670	
25-Jan-11	8.46	2.10	649	2,730	
24-Sep-10	<10.0	<10.0	654	2,250	
28-Jun-10	3.6	<1.0	750	2,790	
23-Mar-10	6.8	ND	1,220	3,868	
14-Dec-09	3.7	0.14	790	2,576	
31-Aug-09	4.7	ND	750	2,548	
1-Jun-09	7.1	ND	650	2,458	
2-Mar-09	2.43	ND	855	2,954	

**TABLE 5. DISCHARGE PLAN MONITORING WELL GROUNDWATER ANALYTICAL RESULTS
DONA ANA DAIRIES, DONA ANA COUNTY, NEW MEXICO**

Monitoring Well	Date Sampled	Nitrate as N (mg/l)	TKN (mg/l)	Chloride (mg/l)	TDS (mg/l)
Sunset/Desert Land Dairy					
257-01	28-Nov-23	32	<0.50	890	3,590
	24-Aug-23	34	<5.0	890	3,540
	17-May-23	31	<5.0	860	3,610
	24-Feb-23	30	<5.0	890	3,460
	22-Nov-22	30	<5.0	930	3,440
	19-Aug-22	35	<5.0	920	3,570
	19-May-22	33	<5.0	1,100	3,700
	28-Feb-22	35	<5.0	870	3,400
	17-Nov-21	34	<5.0	940	3,500
	8-Sep-21	36	<5.0	910	3,560
	20-May-21	30	<5.0	890	3,640
	25-Feb-21	32	<5.0	870	3,620
	20-Nov-20	35	<5.0	910	3,610
	25-Aug-20	39	<2.0	960	4,110
	26-May-20	36	<5.0	850	3,640
	18-Feb-20	31	<5.0	890	3,640
	21-Nov-19	35	<5.0	800	3,720
	6-Aug-19	43	<5.0	910	3,740
	21-May-19	41	<5.0	890	3,800
	1-Mar-19	42	<5.0	900	3,620
	27-Nov-18	45	<5.0	890	3,780
	23-Aug-18	43	<5.0	770	3,890
	23-May-18	42	<5.0	900	4,020
	20-Feb-18	50	<5.0	920	3,820
	16-Nov-17	51.1	<0.0500	870	3,740
	18-Aug-17	48.5	<0.0500	867	3,620
	31-May-17	49.3	<0.0501	848	3,570
	2-Mar-17	45.5	<0.300	847	3,860
	16-Nov-16	44.4	<0.300	681	3,940
	25-Aug-16	48.7	<0.937	817	3,620
	26-May-16	47.7	<2.24	797	3,700
	22-Feb-16	51.9	<1.18	873	3,650
	19-Nov-15	49.1	<1.18	821	3,680
	28-Aug-15	50.4	<10.0	816	3,490
	26-May-15	49.4	3.50	809	3,460
	19-Feb-15	27.5	<1.80	629	2,880
	1-Dec-14	47.9	<1.80	750	3,370
	25-Aug-14	49.4	<1.80	694	3,570
	30-May-14	47.9	3.50	739	3,320
	6-Mar-14	44.3	<1.66	707	3,130
25-Nov-13	42.4	2.80	726	3,090	
28-Aug-13	44.4	5.60	719	3,160	
22-May-13	33.6	<1.66	660	3,100	
21-Feb-13	28.3	<1.72	665	3,200	
21-Nov-12	24.7	2.80	625	3,130	
16-Aug-12	23.2	<1.72	617	3,060	
26-Apr-12	23.7	22.7	680	2,920	
9-Feb-12	19.4	<2.17	603	2,940	
1-Nov-11	28.4	<2.17	619	2,730	
22-Jul-11	44.8	<2.17	673	3,270	
26-Apr-11	103	3.78	870	4,440	
19-Jan-11	59.3	3.08	743	3,420	
24-Sep-10	58.0	<10.0	685	3,120	
28-Jun-10	100	<1.0	820	3,800	
24-Mar-10	187	ND	1,100	4,342	
14-Dec-09	71	0.14	910	3,860	
31-Aug-09	49	ND	880	3,706	
2-Jun-09	64	ND	910	3,822	
3-Mar-09	89	ND	1,135	4,652	

**TABLE 5. DISCHARGE PLAN MONITORING WELL GROUNDWATER ANALYTICAL RESULTS
DONA ANA DAIRIES, DONA ANA COUNTY, NEW MEXICO**

Monitoring Well	Date Sampled	Nitrate as N (mg/l)	TKN (mg/l)	Chloride (mg/l)	TDS (mg/l)
257-02	28-Nov-23	8.6	<0.50	650	2,530
	24-Aug-23	4.5	<1.0	660	2,470
	18-May-23	4.6	<1.0	710	2,680
	24-Feb-23	6.7	<2.0	780	2,860
	22-Nov-22	11	<2.0	860	2,780
	19-Aug-22	6.4	<1.0	760	1,370
	19-May-22	6.9	<1.0	730	2,760
	28-Feb-22	9.4	<1.0	600	2,440
	18-Nov-21	39	<5.0	1,000	3,600
	8-Sep-21	20	<5.0	560	2,280
	19-May-21	10	<2.0	770	2,950
	1-Mar-21	13	<2.0	780	2,940
	20-Nov-20	12	<2.0	770	2,930
	26-Aug-20	12	<2.0	790	2,930
	26-May-20	11	<2.0	710	2,810
	18-Feb-20	7.1	<1.0	710	2,680
	21-Nov-19	5.3	<1.0	620	2,690
	6-Aug-19	9.3	<2.0	650	2,590
	21-May-19	10	<1.0	620	2,480
	1-Mar-19	8.7	<1.0	690	2,570
	27-Nov-18	9.1	<1.0	650	2,680
	23-Aug-18	14	<2.0	540	2,640
	23-May-18	14	<2.0	690	2,530
	20-Feb-18	14	<2.0	610	2,640
	16-Nov-17	14.0	1.04	679	2,430
	18-Aug-17	10.3	<0.0500	754	2,890
	31-May-17	10.0	0.492	696	2,520
	2-Mar-17	16.2	<0.300	634	2,760
	16-Nov-16	10.2	<0.937	671	3,090
	25-Aug-16	4.62	<0.937	814	2,940
	26-May-16	7.28	<2.24	572	2,480
	22-Feb-16	4.98	<1.18	455	1,920
	19-Nov-15	12.2	<1.18	800	2,890
	28-Aug-15	8.86	<10.0	632	2,700
	26-May-15	9.36	1.40	727	2,660
	19-Feb-15	8.45	<1.80	610	2,440
	1-Dec-14	6.39	<1.80	669	2,760
	25-Aug-14	6.53	<1.80	585	2,550
	30-May-14	11.5	2.10	531	2,100
	6-Mar-14	10.4	<1.66	530	2,120
25-Nov-13	11.1	2.80	529	2,070	
28-Aug-13	7.59	8.40	511	2,200	
22-May-13	3.39	<1.66	469	1,880	
21-Feb-13	10.3	<1.72	470	1,980	
21-Nov-12	10.0	2.80	468	2,060	
16-Aug-12	14.8	<1.72	484	2,170	
26-Apr-12	23.2	8.40	505	1,840	
9-Feb-12	11.1	<2.17	443	1,840	
1-Nov-11	19.3	2.24	442	3,150	
22-Jul-11	28.7	<2.17	501	2,160	
26-Apr-11	24.9	2.80	433	2,000	
19-Jan-11	13.3	2.52	455	1,500	
24-Sep-10	21.0	<10.0	445	1,590	
29-Jun-10	24	<1.0	560	2,180	
24-Mar-10	22.3	ND	570	1,840	
14-Dec-09	19.3	0.14	480	1,916	
31-Aug-09	14.2	ND	410	1,518	
2-Jun-09	1.86	ND	500	1,690	
3-Mar-09	30.4	ND	495	1,632	

**TABLE 5. DISCHARGE PLAN MONITORING WELL GROUNDWATER ANALYTICAL RESULTS
DONA ANA DAIRIES, DONA ANA COUNTY, NEW MEXICO**

Monitoring Well	Date Sampled	Nitrate as N (mg/l)	TKN (mg/l)	Chloride (mg/l)	TDS (mg/l)
257-03	27-Nov-23	Not Sampled - Unknown Blockage in Well			
	24-Aug-23	30	<5.0	370	2,000
	17-May-23	Not Sampled - Unknown Blockage in Well			
	23-Feb-23	Not Sampled - Unknown Blockage in Well			
	22-Nov-22	11	2.0	630	2,630
	22-Aug-22	5.2	2.0	570	2,620
	19-May-22	Not Sampled - Unknown Blockage in Well			
	28-Feb-22	Not Sampled - Unknown Blockage in Well			
	18-Nov-21	Not Sampled - Unknown Blockage in Well			
	8-Sep-21	15	<2.0	780	2,900
	20-May-21	Not Sampled - Insufficient water to sample			
	1-Mar-21	17	2.2	700	2,870
	20-Nov-20	19	2.5	590	2,890
	26-Aug-20	9.9	3.6	720	2,830
	26-May-20	Dry			
	18-Feb-20	16	2.2	660	2,730
	21-Nov-19	4.4	1.8	570	2,640
	6-Aug-19	5.9	2.2	750	2,900
	21-May-19	Dry			
	1-Mar-19	12	<2.0	710	2,670
	27-Nov-18	5.8	2.1	570	2,480
	23-Aug-18	11	<2.0	600	2,760
	23-May-18	11	2.5	430	2,060
	20-Feb-18	12	2.2	530	2,510
	16-Nov-17	13.8	1.99	523	2,150
	18-Aug-17	14.3	0.742	605	2,540
	31-May-17	10.1	1.13	402	2,330
	2-Mar-17	15.4	0.412	346	2,220
	16-Nov-16	12.50	1.70	344	1,860
	25-Aug-16	9.97	<0.937	333	1,860
	26-May-16	Dry			
	22-Feb-16	Not Sampled - insufficient water to sample			
	19-Nov-15	Dry			
	28-Aug-15	5.37	<10.0	477	2,060
	26-May-15	Dry			
	19-Feb-15	Not Sampled - insufficient water to sample			
	1-Dec-14	Dry			
	25-Aug-14	7.64	<1.80	413	1,840
	30-May-14	Dry			
	6-Mar-14	6.06	<1.66	546	2,380
	25-Nov-13	2.03	4.90	494	1,900
	28-Aug-13	4.55	4.90	569	2,360
	22-May-13	7.23	<1.66	658	2,640
	21-Feb-13	2.65	<1.72	520	2,060
	21-Nov-12	3.11	2.80	490	2,250
	16-Aug-12	17.6	2.10	509	2,420
	26-Apr-12	6.60	4.20	601	2,330
14-Feb-12	11.2	<2.17	636	2,620	
1-Nov-11	7.37	2.80	537	2,210	
22-Jul-11	12.9	2.80	576	2,100	
26-Apr-11	12.5	5.88	525	2,400	
19-Jan-11	2.67	2.24	377	1,600	
24-Sep-10	8.00	<10.0	400	1,670	
29-Jun-10	17	1.1	660	2,570	
24-Mar-10	10.1	1.12	640	2,342	
14-Dec-09	5.9	0.56	760	2,638	
31-Aug-09	10.7	0.84	610	2,260	
2-Jun-09	5.99	ND	570	2,284	
3-Mar-09	334*	ND	690	2,538	

**TABLE 5. DISCHARGE PLAN MONITORING WELL GROUNDWATER ANALYTICAL RESULTS
DONA ANA DAIRIES, DONA ANA COUNTY, NEW MEXICO**

Monitoring Well	Date Sampled	Nitrate as N (mg/l)	TKN (mg/l)	Chloride (mg/l)	TDS (mg/l)
257/260-01	2-Feb-18	Plugged and Abandoned			
	16-Nov-17	Not Sampled - Inaccessible Due to Crops			
	18-Aug-17	0.0935	18.6	678	2,730
	31-May-17	0.193	28.3	665	2,460
	2-Mar-17	<2.00	83.7	636	2,720
	16-Nov-16	0.857	29.2	527	2,300
	9-Sep-16	16.7	5.11	254	1,660
	26-May-16	<0.305	12.1	588	2,460
	22-Feb-16	<0.305	37.0	598	2,830
	19-Nov-15	<0.194	15.7	542	2,260
	28-Aug-15	8.81	<10.0	210	1,140
	26-May-15	2.02	18.9	726	2,750
	19-Feb-15	1.09	<1.80	445	2,220
	1-Dec-14	4.92	2.80	375	1,520
	25-Aug-14	3.74	6.30	562	2,440
	30-May-14	4.82	2.10	658	2,640
	6-Mar-14	4.22	<1.66	644	2,780
	25-Nov-13	3.30	6.30	580	2,220
	28-Aug-13	2.81	7.70	624	2,460
	22-May-13	2.39	<1.66	673	2,820
	21-Feb-13	9.35	<1.72	816	2,980
	21-Nov-12	13.0	3.50	722	3,020
	16-Aug-12	3.67	6.30	667	2,620
	26-Apr-12	6.83	2.80	575	2,660
	14-Feb-12	9.68	<2.17	565	2,180
	1-Nov-11	16.7	2.94	658	2,850
	22-Jul-11	4.66	3.64	440	1,860
	26-Apr-11	<0.500	4.34	624	2,580
	19-Jan-11	1.21	4.20	480	1,860
	24-Sep-10	11.0	<10.0	576	2,480
	30-Jun-10	5.4	<5.0	530	1,980
	23-Mar-10	5.0	ND	340	982
14-Dec-09	45	26.32	220	520	
31-Aug-09	0.3	8.7	570	1,704	
2-Jun-09	1.65	7.0	660	1,936	
3-Mar-09	3.98	1.12	555	1,908	

**TABLE 5. DISCHARGE PLAN MONITORING WELL GROUNDWATER ANALYTICAL RESULTS
DONA ANA DAIRIES, DONA ANA COUNTY, NEW MEXICO**

Monitoring Well	Date Sampled	Nitrate as N (mg/l)	TKN (mg/l)	Chloride (mg/l)	TDS (mg/l)
Las Cruces Community Farms (Former McAnally Enterprises)					
MW-4	28-Nov-23	1.1	<0.50	1,400	4,310
	24-Aug-23	1.2	<1.0	1,200	4,010
	18-May-23	<1.0	<1.0	1,500	4,700
	24-Feb-23	1.1	<1.0	1,400	4,290
	22-Nov-22	<1.0	<1.0	1,500	4,640
	22-Aug-22	1.3	<1.0	1,800	5,140
	20-May-22	1.5	<1.0	1,300	4,170
	28-Feb-22	1.3	<1.0	1,300	4,150
	18-Nov-21	2.7	<1.0	1,200	3,860
	8-Sep-21	1.8	<1.0	1,400	4,270
	20-May-21	2.2	<1.0	1,300	3,980
	1-Mar-21	1.5	<1.0	1,600	4,820
	20-Nov-20	1.1	<1.0	1,500	4,550
	26-Aug-20	1.2	<1.0	1,500	4,640
	26-May-20	<1.0	1.1	1,400	4,460
	6-Mar-20	<1.0	<2.0	1,600	4,620
	26-Nov-19	0.39	<1.0	1,400	4,800
	19-Jun-18	4.6	<1.0	1,200	980
	21-Jul-15	1.6	<1	1,900	5,300
9-Jun-15	1.5	<1.0	1,900	5,100	
13-Mar-09	3.5	<0.5	2,110	5,686	
NMWQCC Standard		10	NA	250	1,000
Existing Conditions - August 2020		NA	NA	367	1,758
Existing Conditions - Pre-August 2020*		NA	NA	1,718	5,328
Southern Area					
Del Oro Dairy					
692-01 (Perched)	22-Dec-15	Plugged & Abandoned			
	2-Dec-15	78.4	<1.18	579	2,420
	31-Aug-15	Pump was not operational			
	28-May-15	Pump was not operational			
	3-Mar-15	Pump was not operational			
	2-Dec-14	99.4	4.90	678	2,830
	27-Aug-14	95.6	9.10	643	2,910
	2-Jun-14	98.2	4.20	612	2,660
	13-Mar-14	97.8	<1.66	647	2,820
	4-Dec-13	2.57	7.00	706	2,840
	4-Sep-13	Not Sampled			
	28-May-13	82.4	<1.66	612	2,660
	27-Feb-13	87.9	<1.72	654	2,690
	30-Nov-12	117	<1.72	821	3,490
	20-Aug-12	Pump was not operational			
	8-May-12	163	<1.72	1,060	4,820
	17-Feb-12	166	7.28	1,090	4,000
	8-Nov-11	168	6.44	1,180	4,690
	29-Jul-11	176	<2.17	1,210	4,840
	22-Apr-11	140		998	3,880
	19-Jan-11	213	2.10	1,070	4,320
	1-Oct-10	222	<10.0	1,060	4,640
	30-Jun-10	230	<5.0	1,100	4,080
30-Mar-10	117.5	3	1,080	3,991	
8-Dec-09	107	1	1,060	4,897	
12-Aug-09	127	3	1,120	4,955	
4-May-09	120	3	1,160	4,295	

**TABLE 5. DISCHARGE PLAN MONITORING WELL GROUNDWATER ANALYTICAL RESULTS
DONA ANA DAIRIES, DONA ANA COUNTY, NEW MEXICO**

Monitoring Well	Date Sampled	Nitrate as N (mg/l)	TKN (mg/l)	Chloride (mg/l)	TDS (mg/l)
692-02 (Perched)	29-Nov-23	13	<0.50	450	1,720
	25-Aug-23	31	<5.0	480	1,830
	18-May-23	25	<5.0	440	1,590
	27-Feb-23	21	<5.0	410	1,430
	28-Nov-22	17	<2.0	360	1,410
	22-Aug-22	11	<2.0	350	1,260
	20-May-22	4.4	<1.0	300	1,050
	1-Mar-22	5.0	<1.0	300	1,060
	19-Nov-21	1.1	<1.0	270	953
	23-Aug-21	<1.0	<1.0	290	912
	20-May-21	<1.0	<1.0	280	892
	9-Mar-21	<1.0	<1.0	270	877
	23-Nov-20	<1.0	<1.0	250	879
	26-Aug-20	<1.0	<1.0	280	871
	26-May-20	<1.0	<1.0	280	868
	19-Feb-20	<1.0	<1.0	270	882
	2-Dec-19	<1.0	<1.0	260	890
	15-Aug-19	2.2	<1.0	380	1,210
	29-May-19	2.5	<1.0	290	964
	7-Mar-19	67	<5.0	640	2,560
	27-Nov-18	58	<5.0	620	2,440
	23-Aug-18	66	<5.0	610	2,690
	30-May-18	64	<5.0	690	2,770
	23-Feb-18	82	<5.0	840	2,960
	30-Nov-17	43.4	<0.0500	746	2,300
	23-Aug-17	24.4	<0.0500	660	2,290
	5-Jun-17	2.82	1.01	421	1,640
	2-Mar-17	17.8	<0.300	583	2,250
	30-Nov-16	103	<0.300	803	3,300
	6-Sep-16	111	<0.937	869	3,340
	31-May-16	124	<2.24	879	3,520
	24-Feb-16	140	<1.18	990	3,480
	2-Dec-15	134	2.24	967	3,500
	31-Aug-15	140	4.90	995	3,660
	26-May-15	140	4.20	973	3,430
	3-Mar-15	142	2.10	963	3,640
	2-Dec-14	147	<1.80	974	3,430
	27-Aug-14	132	2.80	909	3,510
	30-May-14	128	4.20	906	3,370
	7-Mar-14	129	<1.66	912	3,420
	3-Dec-13	108	2.80	906	3,520
	4-Sep-13	120	2.80	925	3,600
23-May-13	47.8	<1.66	742	2,720	
27-Feb-13	3.37	<1.72	396	1,520	
30-Nov-12	<0.0290	<1.72	358	1,450	
20-Aug-12	1.72	<1.72	371	1,460	
8-May-12	1.75	<1.72	339	1,350	
17-Feb-12	2.55	<2.17	410	1,490	
31-Oct-11	4.69	<2.17	451	1,720	
29-Jul-11	24.1	<2.17	504	2,280	
27-Apr-11	92.3	<10.0	921	3,080	
26-Jan-11	47.2	3.64	706	2,490	
1-Oct-10	Not Sampled				
30-Jun-10	140	<5.0	1,100	3,520	
30-Mar-10	107.5	1	1,320	3,861	
8-Dec-09	96	1	1,200	4,073	
12-Aug-09	66	3	1,140	4,317	
4-May-09	52	1	1,100	3,337	

**TABLE 5. DISCHARGE PLAN MONITORING WELL GROUNDWATER ANALYTICAL RESULTS
DONA ANA DAIRIES, DONA ANA COUNTY, NEW MEXICO**

Monitoring Well	Date Sampled	Nitrate as N (mg/l)	TKN (mg/l)	Chloride (mg/l)	TDS (mg/l)
692-03	30-Mar-10	Plugged and Abandoned			
	4-May-09				
692-04 (Perched)	29-Nov-23	Dry			
	25-Aug-23				
	18-May-23				
	27-Feb-23				
	28-Nov-22				
	23-Aug-22	Not Sampled - insufficient water to sample			
	20-May-22	57	<5.0	680	2,570
	1-Mar-22	29	<5.0	570	2,460
	19-Nov-21	33	<5.0	520	2,460
	20-Aug-21	Not Sampled - insufficient water to sample			
	20-May-21				
	9-Mar-21	15	4.5	540	1,810
	23-Nov-20	18	9.5	520	2,350
	26-Aug-20	24	15	640	2,370
	26-May-20	69	2.8	910	3,240
	19-Feb-20	49	<5.0	680	2,460
	2-Dec-19	48	<5.0	610	2,450
	15-Aug-19	29	4.80	600	2,230
	29-May-19	Dry			
	7-Mar-19	Dry			
	27-Nov-08	Dry			
	23-Aug-18	Dry			
	30-May-18	Dry			
	23-Feb-18	Dry			
	23-Aug-17	Dry			
	5-Jun-17	Dry			
	2-Mar-17	Dry			
	30-Nov-16	Dry			
	2-Sep-16	Dry			
	31-May-16	Dry			
	24-Feb-16	Dry			
	2-Dec-15	Dry			
	31-Aug-15	Dry			
	26-May-15	Dry			
	3-Mar-15	Not Sampled - insufficient water to sample			
	2-Dec-14	27.1	<1.80	582	2,000
	28-Aug-14	32.5	<1.80	508	2,060
	30-May-14	38.7	4.20	481	2,010
	7-Mar-14	44.4	<1.66	581	2,290
	3-Dec-13	43.5	2.80	646	2,490
	4-Sep-13	Not Sampled - insufficient water to sample			
23-May-13	71.3	<1.66	676	2,740	
27-Feb-13	25.2	<1.72	625	2,390	
30-Nov-12	24.3	<1.72	573	2,540	
20-Aug-12	42.1	<1.72	689	2,850	
8-May-12	39.6	<1.72	652	2,490	
17-Feb-12	30.2	<2.17	557	2,060	
31-Oct-11	22.9	<2.17	477	1,600	
29-Jul-11	25.2	<2.17	503	1,960	
22-Apr-11	98.5	<2.17	893	3,240	
19-Jan-11	148	3.22	1,040	3,740	
28-Sep-10	67.0	<10.0	802	3,060	
30-Jun-10	50	<5.0	590	2,050	
30-Mar-10	28	1	600	2,012	
8-Dec-09	31	1	590	2,069	
12-Aug-09	26	1	680	2,158	
4-May-09	26	1	580	2,081	

**TABLE 5. DISCHARGE PLAN MONITORING WELL GROUNDWATER ANALYTICAL RESULTS
DONA ANA DAIRIES, DONA ANA COUNTY, NEW MEXICO**

Monitoring Well	Date Sampled	Nitrate as N (mg/l)	TKN (mg/l)	Chloride (mg/l)	TDS (mg/l)	
692-05 (Regional)	1-Dec-23	19	<0.50	430	1,610	
	28-Aug-23	16	<2.0	410	1,570	
	23-May-23	14	<2.0	400	1,500	
	28-Feb-23	16	<2.0	430	1,560	
	30-Nov-22	18	<2.0	390	1,610	
	23-Aug-22	17	<2.0	430	1,600	
	20-May-22	15	<1.0	380	1,550	
	2-Mar-22	16	<2.0	400	1,550	
	19-Nov-21	19	<2.0	400	1,600	
	23-Aug-21	18	<2.0	430	1,570	
	21-May-21	14	<2.0	430	1,620	
	9-Mar-21	17	<1.0	410	1,550	
	23-Nov-20	14	<2.0	400	1,580	
	27-Aug-20	14	<2.0	410	1,580	
	27-May-20	12	<2.0	400	1,640	
	19-Feb-20	14	<2.0	420	1,780	
	2-Dec-19	13	<2.0	390	1,510	
	16-Aug-19	12	<2.0	420	1,570	
	29-May-19	13	<2.0	420	1,600	
	14-Mar-19	12	<2.0	410	1,540	
	4-Dec-18	Pump was not operational				
	23-Aug-18	9.1	<1.0	400	1,500	
	30-May-18	Pump was not operational				
	23-Feb-18	Pump was not operational				
	30-Nov-17	11.9	<0.0500	433	1,300	
	22-Aug-17	10.6	<0.0500	450	1,470	
	5-Jun-17	9.24	<0.0500	440	1,430	
	3-Mar-17	8.32	<0.300	425	1,430	
	29-Nov-16	6.85	<0.300	430	1,420	
	2-Sep-16	8.07	<0.937	452	1,420	
	31-May-16	7.29	<2.24	459	1,470	
	24-Feb-16	6.72	<1.18	463	1,540	
	2-Dec-15	5.68	<1.18	457	1,370	
	31-Aug-15	5.03	11.9	496	1,380	
	26-May-15	3.93	<1.18	474	1,440	
	3-Mar-15	3.70	<1.80	430	1,440	
	2-Dec-14	4.80	<1.80	447	1,460	
	27-Aug-14	5.78	<1.80	424	1,340	
	2-Jun-14	6.50	3.50	427	1,460	
	14-Mar-14	1.67	<1.66	452	1,440	
	4-Dec-13	4.05	2.80	437	1,360	
	4-Sep-13	2.12	4.20	446	1,480	
	28-May-13	1.90	<1.66	417	1,280	
	27-Feb-13	2.16	<1.72	410	1,340	
	29-Nov-12	2.28	<1.72	397	1,370	
	16-Aug-12	2.73	17.6	455	1,520	
	7-May-12	1.92	3.08	420	1,570	
17-Feb-12	2.52	<2.17	423	1,310		
8-Nov-11	2.30	2.94	383	1,230		
1-Aug-11	<1.00	3.50	420	1,710		
26-Apr-11	<2.50	<10.0	401	1,710		
19-Jan-11	4.12	2.10	443	1,280		
1-Oct-10	3.10	<10.0	420	1,430		
30-Jun-10	2.1	<1.0	500	1,490		
30-Mar-10	1.5	1	480	1,501		
8-Dec-09	1.4	1	540	1,538		
12-Aug-09	0.8	1	500	1,602		
4-May-09	1.0	1	500	1,477		

**TABLE 5. DISCHARGE PLAN MONITORING WELL GROUNDWATER ANALYTICAL RESULTS
DONA ANA DAIRIES, DONA ANA COUNTY, NEW MEXICO**

Monitoring Well	Date Sampled	Nitrate as N (mg/l)	TKN (mg/l)	Chloride (mg/l)	TDS (mg/l)
692-06 (Regional)	1-Dec-23	4.3	<0.50	430	1,450
	28-Aug-23	4.9	<1.0	410	1,470
	23-May-23	4.8	<1.0	390	1,410
	28-Feb-23	4.6	<1.0	440	1,430
	30-Nov-22	4.6	<1.0	390	1,470
	23-Aug-22	4.9	<1.0	440	1,490
	23-May-22	3.9	<1.0	420	1,420
	2-Mar-22	3.7	<1.0	400	1,380
	22-Nov-21	4.3	<1.0	430	1,500
	24-Aug-21	3.6	<1.0	410	1,490
	21-May-21	3.4	<1.0	420	1,470
	11-Mar-21	3.0	<1.0	390	1,390
	24-Nov-20	4.0	<1.0	420	1,470
	27-Aug-20	3.6	<1.0	400	1,450
	27-May-20	3.1	4.1	370	1,440
	18-Feb-20	3.2	<1.0	420	1,400
	26-Nov-19	4.0	<1.0	420	1,490
	15-Aug-19	3.8	<1.0	420	1,440
	29-May-19	3.3	<1.0	400	1,430
	7-Mar-19	3.1	<1.0	420	1,450
	4-Dec-18	3.7	<1.0	450	1,490
	23-Aug-18	3.5	<1.0	370	1,450
	30-May-18	3.9	<1.0	410	1,420
	23-Feb-18	2.9	<1.0	420	1,430
	30-Nov-17	3.46	<0.0500	420	1,290
	23-Aug-17	3.29	<0.0500	420	1,480
	5-Jun-17	3.20	0.0835	428	1,580
	2-Mar-17	2.84	<0.300	404	1,530
	30-Nov-16	3.12	<0.300	414	1,420
	6-Sep-16	2.86	<0.937	471	1,420
	31-May-16	2.27	<2.24	467	1,420
	24-Feb-16	2.93	<1.18	465	1,410
	2-Dec-15	3.04	<1.18	450	1,420
	31-Aug-15	2.56	<1.18	444	1,400
	26-May-15	4.29	1.40	480	1,410
	3-Mar-15	3.40	<1.80	444	1,440
	2-Dec-14	3.65	<1.80	461	1,440
	27-Aug-14	3.77	<1.80	434	1,420
	2-Jun-14	3.90	3.50	453	1,500
	7-Mar-14	3.03	<1.66	429	1,400
3-Dec-13	3.70	2.10	470	1,470	
4-Sep-13	3.19	2.10	423	1,540	
23-May-13	2.71	<1.66	415	1,370	
27-Feb-13	2.81	<1.72	412	1,390	
4-Dec-12	2.19	<1.72	395	1,380	
16-Aug-12	3.24	3.36	418	1,400	
8-May-12	2.62	<1.72	397	1,620	
17-Feb-12	9.39	<2.17	459	1,200	
8-Nov-11	6.46	<2.17	425	1,450	
1-Aug-11	6.07	2.80	409	1,500	
26-Apr-11	4.50	<10.0	422	1,590	
19-Jan-11	4.95	2.10	431	1,360	
1-Oct-10	11.0	<10.0	373	1,490	
30-Jun-10	7.4	<1.0	440	1,470	
30-Mar-10	3.9	1	460	1,532	
8-Dec-09	2.3	1	540	1,609	
12-Aug-09	2.8	1	440	1,555	
4-May-09	2.9	1	500	1,552	

**TABLE 5. DISCHARGE PLAN MONITORING WELL GROUNDWATER ANALYTICAL RESULTS
DONA ANA DAIRIES, DONA ANA COUNTY, NEW MEXICO**

Monitoring Well	Date Sampled	Nitrate as N (mg/l)	TKN (mg/l)	Chloride (mg/l)	TDS (mg/l)	
692-07 (Regional)	1-Dec-23	2.6	<0.50	550	1,600	
	29-Aug-23	2.8	<1.0	510	1,550	
	24-May-23	3.0	<1.0	510	1,510	
	28-Feb-23	2.7	<1.0	540	1,560	
	1-Dec-22	3.0	<1.0	540	1,650	
	24-Aug-22	3.2	<1.0	480	1,720	
	23-May-22	3.6	<1.0	570	1,670	
	2-Mar-22	2.5	<1.0	510	1,530	
	22-Nov-21	3.1	<1.0	580	1,700	
	24-Aug-21	3.9	<1.0	590	1,760	
	21-May-21	3.6	<1.0	570	1,620	
	11-Mar-21	2.8	<5.0	540	1,640	
	24-Nov-20	3.5	<1.0	590	1,620	
	27-Aug-20	3.2	<1.0	570	1,720	
	19-Jun-20	2.9	<2.0	550	1,790	
	19-Feb-20	Not Sampled - insufficient water to sample				
	26-Nov-19	3.4	<1.0	570	1,650	
	16-Aug-19	3.9	<1.0	540	1,700	
	29-May-19	3.1	<1.0	560	1,690	
	7-Mar-19	3.5	<1.0	580	1,680	
	4-Dec-18	3.5	<1.0	560	1,640	
	23-Aug-18	3.3	<1.0	500	1,650	
	30-May-18	3.3	<1.0	590	1,600	
	23-Feb-18	2.9	<1.0	610	1,630	
	30-Nov-17	3.38	<0.0500	576	1,450	
	23-Aug-17	3.38	<0.0500	576	1,590	
	5-Jun-17	3.18	0.471	570	1,520	
	3-Mar-17	3.14	<0.300	564	1,550	
	29-Nov-16	3.88	<0.300	570	1,660	
	2-Sep-16	3.04	<0.937	591	1,520	
	31-May-16	2.19	<2.24	526	1,660	
	24-Feb-16	3.42	<1.18	618	1,590	
	2-Dec-15	3.13	<1.18	582	1,490	
	31-Aug-15	2.97	<1.18	578	1,570	
	26-May-15	2.93	<1.18	589	1,580	
	3-Mar-15	3.53	<1.80	668	1,580	
	2-Dec-14	Pump was not operational				
	27-Aug-14	Not Sampled - insufficient water to sample				
	2-Jun-14	3.20	2.80	527	1,590	
	14-Mar-14	3.26	<1.66	544	1,580	
	4-Dec-13	4.26	2.10	581	1,600	
	4-Sep-13	4.17	<1.66	550	1,840	
28-May-13	3.68	<1.66	524	1,530		
27-Feb-13	3.82	<1.72	563	1,630		
30-Nov-12	4.05	<1.72	535	1,660		
16-Aug-12	5.36	3.50	549	1,780		
8-May-12	3.55	<1.72	530	1,780		
17-Feb-12	4.76	<2.17	518	1,600		
12-Nov-11	5.22	<2.17	555	780		
1-Aug-11	<1.00	2.66	567	2,000		
26-Apr-11	39.3	<10.0	694	2,520		
19-Jan-11	17.2	2.38	589	1,100		
1-Oct-10	27.0	< 10.0	617	2,300		
30-Jun-10	Not Sampled					
30-Mar-10	42	1	820	2,967		
8-Dec-09	28	1	860	3,131		
12-Aug-09	36	1	780	3,041		
4-May-09	50	1	960	3,480		

**TABLE 5. DISCHARGE PLAN MONITORING WELL GROUNDWATER ANALYTICAL RESULTS
DONA ANA DAIRIES, DONA ANA COUNTY, NEW MEXICO**

Monitoring Well	Date Sampled	Nitrate as N (mg/l)	TKN (mg/l)	Chloride (mg/l)	TDS (mg/l)
692-08 (Regional)	4-Dec-23	3.1	<0.50	400	1,380
	29-Aug-23	2.3	<1.0	370	1,280
	24-May-23	5.2	<1.0	360	1,290
	1-Mar-23	3.0	<1.0	430	1,330
	1-Dec-22	1.6	<1.0	420	1,370
	24-Aug-22	1.9	<1.0	360	1,370
	23-May-22	6.2	<1.0	400	1,380
	2-Mar-22	5.0	<1.0	390	1,370
	22-Nov-21	6.8	<1.0	380	1,400
	24-Aug-21	2.1	<1.0	410	1,390
	21-May-21	1.7	<2.0	410	1,390
	11-Mar-21	2.3	<1.0	400	1,350
	24-Nov-20	2.1	<1.0	390	1,360
	27-Aug-20	1.9	<1.0	430	1,400
	27-May-20	1.4	<1.0	400	1,400
	18-Feb-20	3.9	<1.0	430	1,380
	25-Nov-19	1.8	<1.0	360	1,350
	16-Aug-19	1.2	<1.0	390	1,340
	29-May-19	2.8	<1.0	410	1,380
	7-Mar-19	2.6	<1.0	420	1,400
	4-Dec-18	2.4	<1.0	420	1,370
	23-Aug-18	2.1	<1.0	370	1,380
	30-May-18	2.5	<1.0	420	1,340
	23-Feb-18	3.0	<1.0	410	1,360
	30-Nov-17	4.74	<0.0500	420	1,280
	22-Aug-17	2.29	<0.0500	416	1,370
	5-Jun-17	2.12	1.93	413	1,300
	3-Mar-17	2.84	<0.300	412	1,270
	30-Nov-16	2.26	0.567	422	1,340
	2-Sep-16	0.791	1.14	473	1,320
	31-May-16	1.58	<2.24	437	1,340
	24-Feb-16	3.22	<1.18	448	1,300
	2-Dec-15	1.91	<1.18	434	1,330
	31-Aug-15	<0.194	<1.18	432	1,380
	28-May-15	0.652	<1.18	460	1,430
	2-Mar-15	3.34	<1.80	433	1,360
	2-Dec-14	2.65	<1.80	437	1,370
	27-Aug-14	2.71	<1.80	418	1,300
	2-Jun-14	4.70	4.90	435	1,300
	14-Mar-14	4.27	<1.66	435	1,430
	4-Dec-13	3.22	<1.66	456	1,320
	4-Sep-13	3.58	2.10	430	1,360
28-May-13	3.49	<1.66	434	2,760	
27-Feb-13	6.27	<1.72	424	1,380	
30-Nov-12	11.7	<1.72	393	1,500	
20-Aug-12	2.98	<1.72	410	1,340	
8-May-12	1.84	<1.72	364	1,560	
17-Feb-12	3.94	<2.17	452	1,390	
8-Nov-11	2.60	2.80	436	1,340	
1-Aug-11	<1.00	<2.17	386	2,240	
26-Apr-11	3.49	<10.0	435	1,440	
19-Jan-11	3.26	<2.05	431	1,120	
1-Oct-10	5.70	<10.0	386	1,390	
30-Jun-10	3.5	<1.0	460	1,430	
30-Mar-10	3.0	1	520	1,518	
8-Dec-09	2.5	1	500	1,459	
12-Aug-09	1.8	1	520	1,476	
4-May-09	2.0	1	480	1,476	

**TABLE 5. DISCHARGE PLAN MONITORING WELL GROUNDWATER ANALYTICAL RESULTS
DONA ANA DAIRIES, DONA ANA COUNTY, NEW MEXICO**

Monitoring Well	Date Sampled	Nitrate as N (mg/l)	TKN (mg/l)	Chloride (mg/l)	TDS (mg/l)	
692-09 (Regional)	4-Dec-23	3.4	<0.50	400	1,410	
	28-Aug-23	4.2	<1.0	400	1,390	
	23-May-23	7.0	<1.0	380	1,380	
	28-Feb-23	8.2	<1.0	400	1,400	
	30-Nov-22	8.4	<1.0	370	1,430	
	23-Aug-22	5.4	<1.0	410	1,420	
	20-May-22	7.4	<1.0	370	1,410	
	1-Mar-22	8.5	<1.0	360	1,460	
	19-Nov-21	5.3	<1.0	410	1,420	
	23-Aug-21	3.6	<1.0	410	1,370	
	20-May-21	3.2	<1.0	400	1,420	
	9-Mar-21	8.2	<1.0	390	1,380	
	23-Nov-20	3.4	<1.0	380	1,370	
	26-Aug-20	4.7	<1.0	400	1,410	
	27-May-20	3.9	<1.0	380	1,400	
	19-Feb-20	Not Sampled - insufficient water to sample				
	2-Dec-19	6.4	<1.0	350	1,420	
	16-Aug-19	5.4	<1.0	380	1,410	
	29-May-19	3.9	<1.0	390	1,390	
	7-Mar-19	3.0	<1.0	390	1,400	
	4-Dec-18	3.2	<1.0	400	1,410	
	23-Aug-18	3.1	<1.0	350	1,410	
	30-May-18	4.2	<1.0	410	1,420	
	23-Feb-18	<1.0	<1.0	410	1,380	
	30-Nov-17	0.746	<0.0500	405	970	
	22-Aug-17	3.93	<0.0500	411	1,360	
	5-Jun-17	2.76	1.47	408	1,340	
	3-Mar-17	4.22	<0.300	399	1,320	
	30-Nov-16	4.39	<0.300	420	1,380	
	2-Sep-16	0.794	<0.937	426	1,340	
	31-May-16	2.96	<2.24	438	1,400	
	24-Feb-16	3.38	<1.18	445	1,280	
	2-Dec-15	2.88	<1.18	435	1,320	
	31-Aug-15	3.04	<1.18	434	1,290	
	28-May-15	2.85	<1.18	460	1,380	
	3-Mar-15	2.35	<1.80	428	1,300	
	2-Dec-14	1.94	<1.80	444	1,420	
	28-Aug-14	4.36	<1.80	418	1,450	
	2-Jun-14	6.81	<1.80	459	1,300	
	14-Mar-14	6.08	<1.66	453	1,460	
	4-Dec-13	3.43	2.10	465	1,440	
4-Sep-13	8.52	3.50	452	1,460		
28-May-13	8.92	<1.66	457	1,410		
27-Feb-13	9.50	<1.72	465	1,440		
29-Nov-12	7.91	13.3	425	1,410		
20-Aug-12	7.71	<1.72	400	1,480		
7-May-12	7.80	<1.72	391	1,470		
17-Feb-12	6.89	<2.17	457	1,450		
8-Nov-11	10.6	<2.17	455	1,400		
1-Aug-11	12.6	<2.17	407	1,300		
26-Apr-11	10.8	<10.0	420	1,140		
18-Jan-11	12.0	<2.05	460	1,160		
1-Oct-10	15.0	<10.0	387	1,480		
30-Jun-10	22	<5.0	480	1,500		
30-Mar-10	11	1	520	1,606		
8-Dec-09	10	1	460	1,536		
12-Aug-09	6	1	460	1,675		
4-May-09	6	1	480	1,545		

**TABLE 5. DISCHARGE PLAN MONITORING WELL GROUNDWATER ANALYTICAL RESULTS
DONA ANA DAIRIES, DONA ANA COUNTY, NEW MEXICO**

Monitoring Well	Date Sampled	Nitrate as N (mg/l)	TKN (mg/l)	Chloride (mg/l)	TDS (mg/l)
692-10 (Regional)	1-Dec-23	<1.0	<2.5	660	1,610
	29-Aug-23	<1.0	<1.0	630	1,640
	24-May-23	<1.0	<2.0	630	1,520
	1-Mar-23	<1.0	<1.0	640	1,540
	30-Nov-22	<1.0	1.4	610	1,830
NMWQCC Standard		10	NA	250	1,000
Existing Conditions - August 2020		NA	NA	455	1,424
Existing Conditions - Pre-August 2020*		NA	NA	503	2,552

NOTES:

Data suspect

* = Pre-August 2020 existing conditions were in place prior to August 2020. This condition is no longer applicable.

mg/l = milligrams per liter

ND = Non-detect

NMWQCC = New Mexico Water Quality Control Commission

TDS = Total dissolved solids

TKN = Total Kjeldahl nitrogen

Data from current quarter.

Highlight is at or above NMWQCC Standard.

Highlight is at or above August 2020 existing conditions value. Applicable to samples collected in or after August 2020.

FIGURES

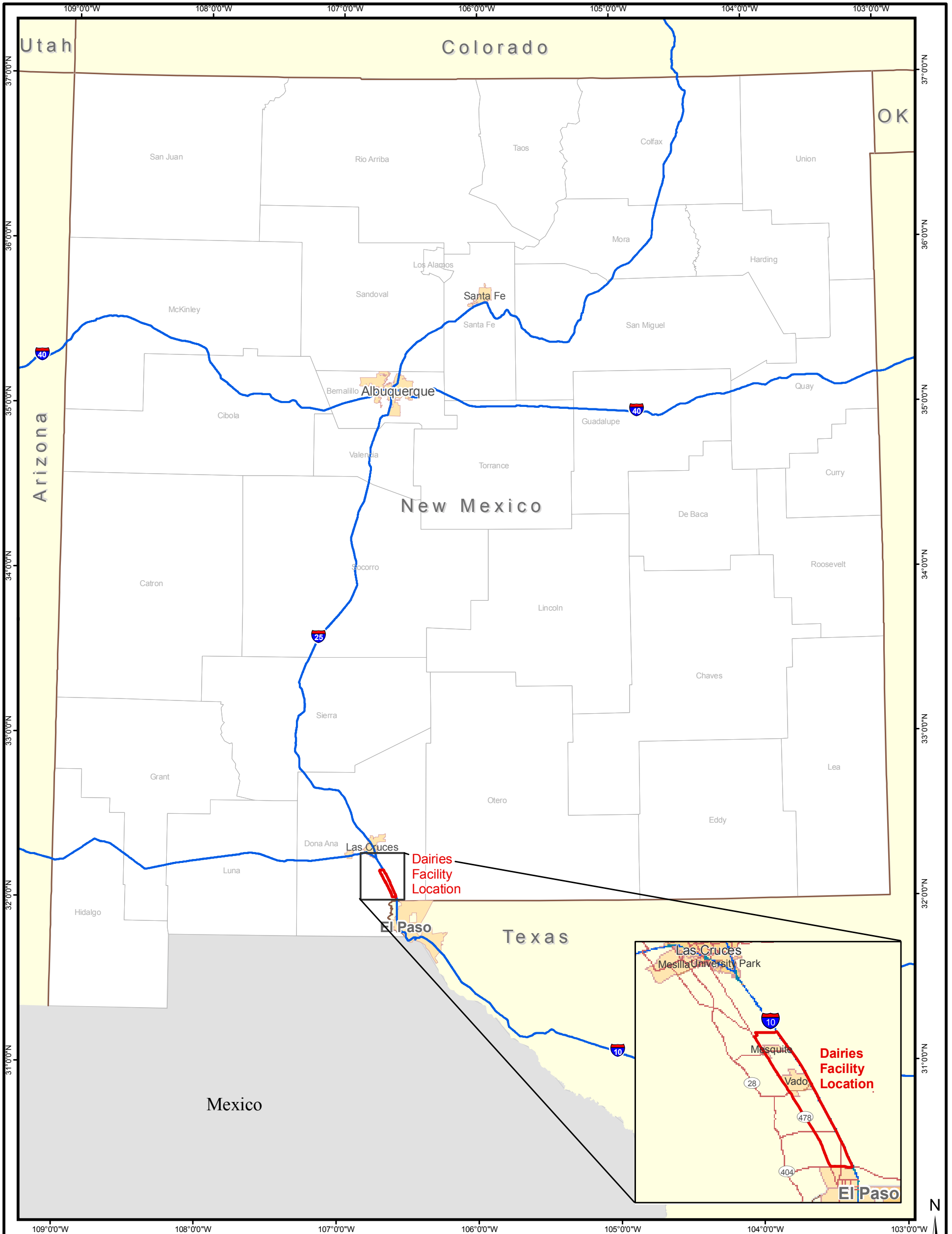

LEGEND:

 Facility Boundary

REFERENCES

Base Data: ESRI, 2008.

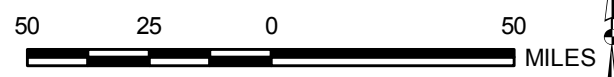

SCALE 1:2,500,000
WHEN PRODUCED AT 11X17IN

PROJECT		DOÑA ANA DAIRIES MESQUITE, NEW MEXICO	
TITLE		SITE LOCATION MAP	
	PROJECT No.	11x17_siteloc.mxd	
	DESIGN		SCALE AS SHOWN
	GIS		REV 0
	CHECK		
REVIEW			
			FIGURE 1

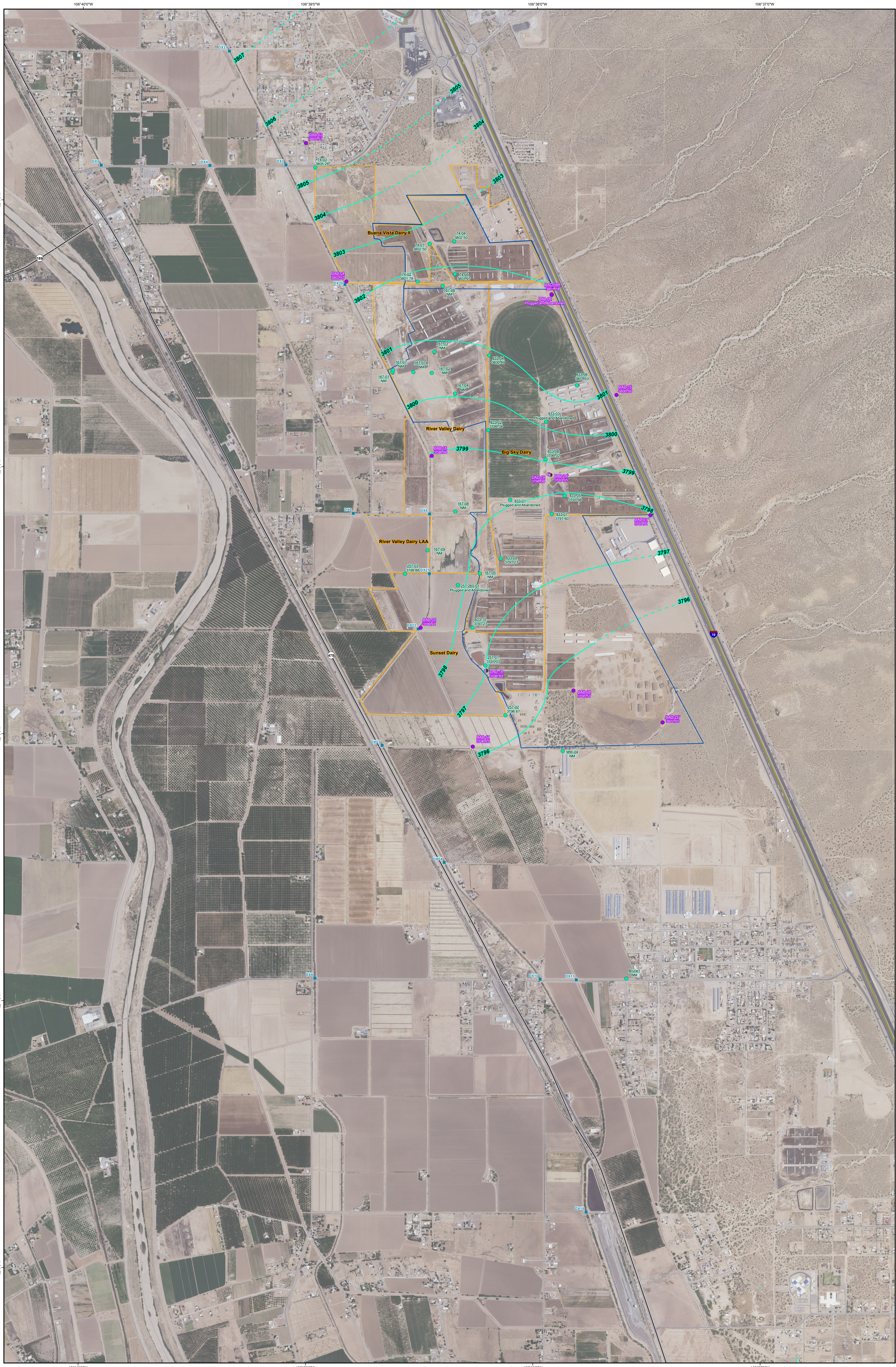

- Discharge Plan Well with Water Elevation (Feet MSL)
- Abatement Plan Well With Water Elevations (Feet MSL)
- Abatement Plan Vertical Delineation Well
- Abatement Plan Well - Plugged and Abandoned
- Discharge Plan Well - Plugged and Abandoned
- Drain Crossing Location
- - - Potentiometric Contour
- Potentiometric Contour - Inferred
- Land Owned by Dairies
- Land Application on Non-Dairy Property
- Stage 2 Abatement Plan Area

Note:
 * Well not used in contouring
 Feet MSL = Feet above mean sea level
 NM = Not measured

REFERENCES
 Roeder, Dona Area County, 2001
 Aerial Photography: NAIP, 2022
 Projection: State Plane NAD 83 New Mexico Central (feet)

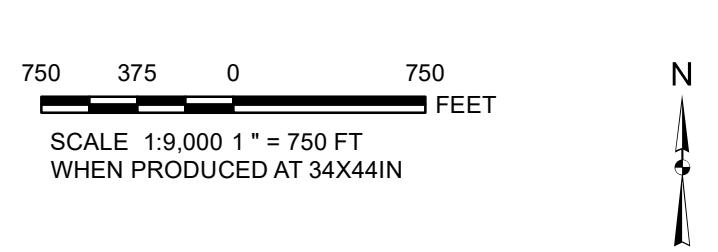

PROJECT	DOÑA ANA DAIRIES MESQUITE, NEW MEXICO								
MAP	POTENTIOMETRIC SURFACE MAP NOVEMBER 2023, CENTRAL PORTION								
	<table border="1" style="font-size: 8px; border-collapse: collapse;"> <tr> <td>PROJECT NO.</td> <td>2023-011</td> </tr> <tr> <td>DATE</td> <td>11/15/2023</td> </tr> <tr> <td>SCALE</td> <td>AS SHOWN</td> </tr> <tr> <td>PROJECT</td> <td>DOÑA ANA DAIRIES</td> </tr> </table>	PROJECT NO.	2023-011	DATE	11/15/2023	SCALE	AS SHOWN	PROJECT	DOÑA ANA DAIRIES
PROJECT NO.	2023-011								
DATE	11/15/2023								
SCALE	AS SHOWN								
PROJECT	DOÑA ANA DAIRIES								
FIGURE 3									

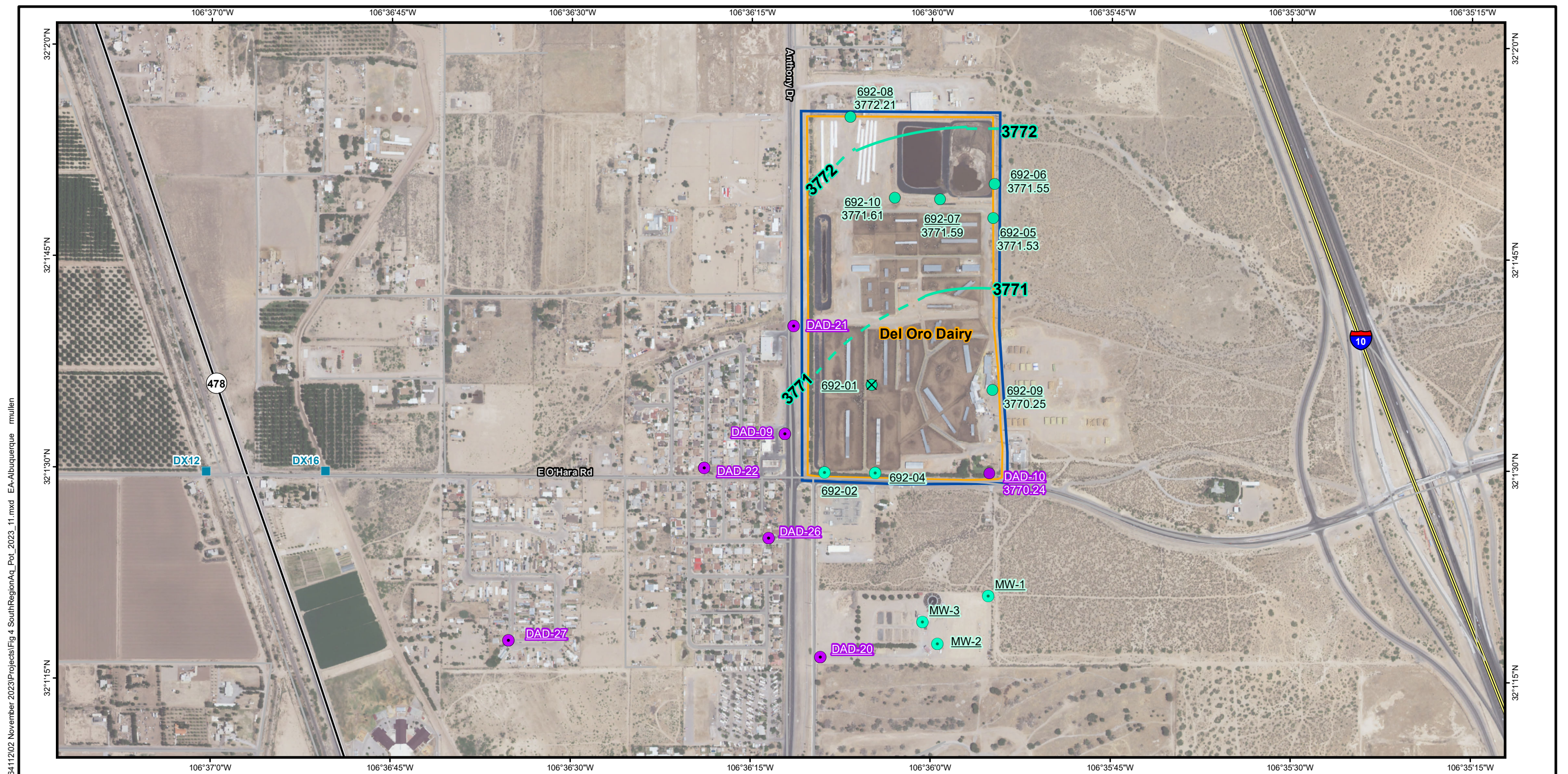

2024-01-02 P:\gis2\Commercial\Dona Ana Dairies - 21464112\02 November 2023\Projects\Fig 4 SouthRegionAq_Pot_2023_11.mxd EA-Albuquerque mullen

LEGEND:

- Drain Crossing Location
- Perched Aquifer Monitoring Well**
- Abatement Plan Well
- Discharge Plan Well
- ⊗ Discharge Plan Well - Plugged and Abandoned
- Regional Aquifer Monitoring Well**
- Abatement Plan Well With Water Elevations (Feet Above Mean Sea Level)
- Discharge Plan Well with Water Elevation (Feet Above Mean Sea Level)
- Potentiometric Contour
- - - Potentiometric Contour - Inferred
- Land Owned by Dairies
- Stage 2 Abatement Plan Area

* Well not used in contouring

REFERENCES
 Aerial Photography: NAIP 2022
 Projection: State Plane NAD 83 New Mexico Central (feet)

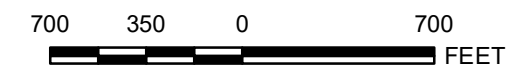

SCALE 1:8,400 1" = 700 FT
 WHEN PRODUCED AT 11X17IN



DOÑA ANA DAIRIES MESQUITE, NEW MEXICO			
POTENTIOMETRIC SURFACE MAP NOVEMBER 2023, SOUTHERN PORTION REGIONAL AQUIFER			
	PROJECT No. 21464112.02		Fig 4 SouthRegionAq_Pot.mxd
	DESIGN	NA	SCALE AS SHOWN
	GIS	RMM	REV 0
	CHECK	TM	
	REVIEW	TM	
			FIGURE 4

2024-02-29 P:\gis2\Commercial\Dona Ana Dairies - 21464112\03 November 2023\Projects\Fig 5 SouthPerchAq_Pot_2023_11.mxd EA-Albuquerque sfinch

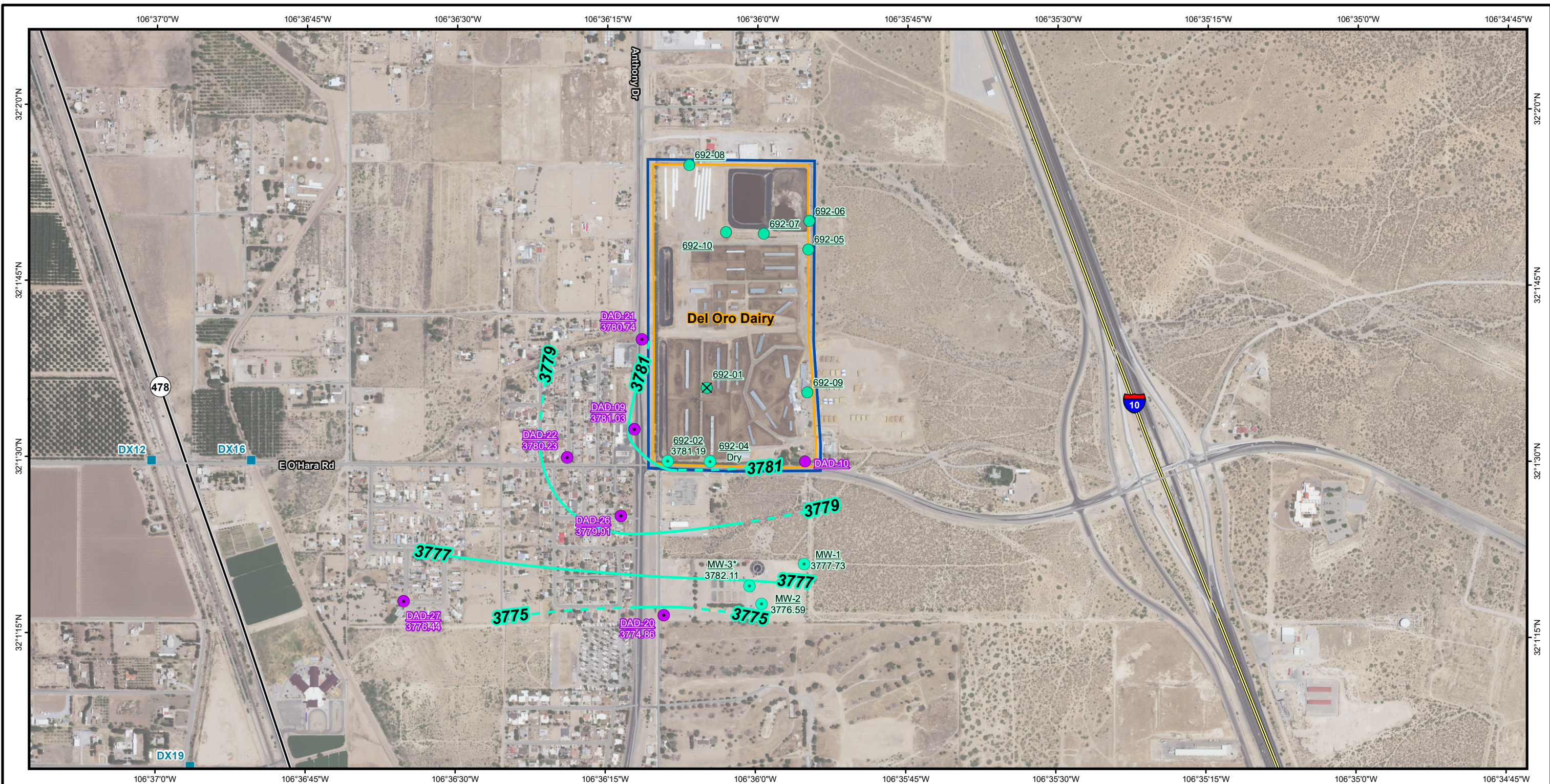

LEGEND:

- Drain Crossing Location
- Perched Aquifer Monitoring Well**
 - Abatement Plan Well With Water Elevations (Feet Above Mean Sea Level)
 - Discharge Plan Well with Water Elevation (Feet Above Mean Sea Level)
 - ✕ Discharge Plan Well - Plugged and Abandoned
- Regional Aquifer Monitoring Well**
 - Abatement Plan Well
 - Discharge Plan Well
- Potentiometric Contour
- - - Potentiometric Contour - Inferred
- Land Owned by Dairies
- Stage 2 Abatement Plan Area

Note:
* = Not used in contouring.

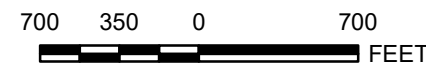

SCALE 1:10,150 1" = 845.795782 FT
WHEN PRODUCED AT 11X17IN



REFERENCES

Aerial Photography: NAIP 2022
Projection: State Plane NAD 83 New Mexico Central (feet)

DOÑA ANA DAIRIES MESQUITE, NEW MEXICO			
POTENTIOMETRIC SURFACE MAP NOVEMBER 2023, SOUTHERN PORTION PERCHED AQUIFER			
	PROJECT No. 21464112.04		SCALE AS SHOWN
	DESIGN	NA	REV 0
	GIS	RMM	
	CHECK	TM	
REVIEW	TM		FIGURE 5

106°41'0"W 106°40'0"W 106°39'0"W

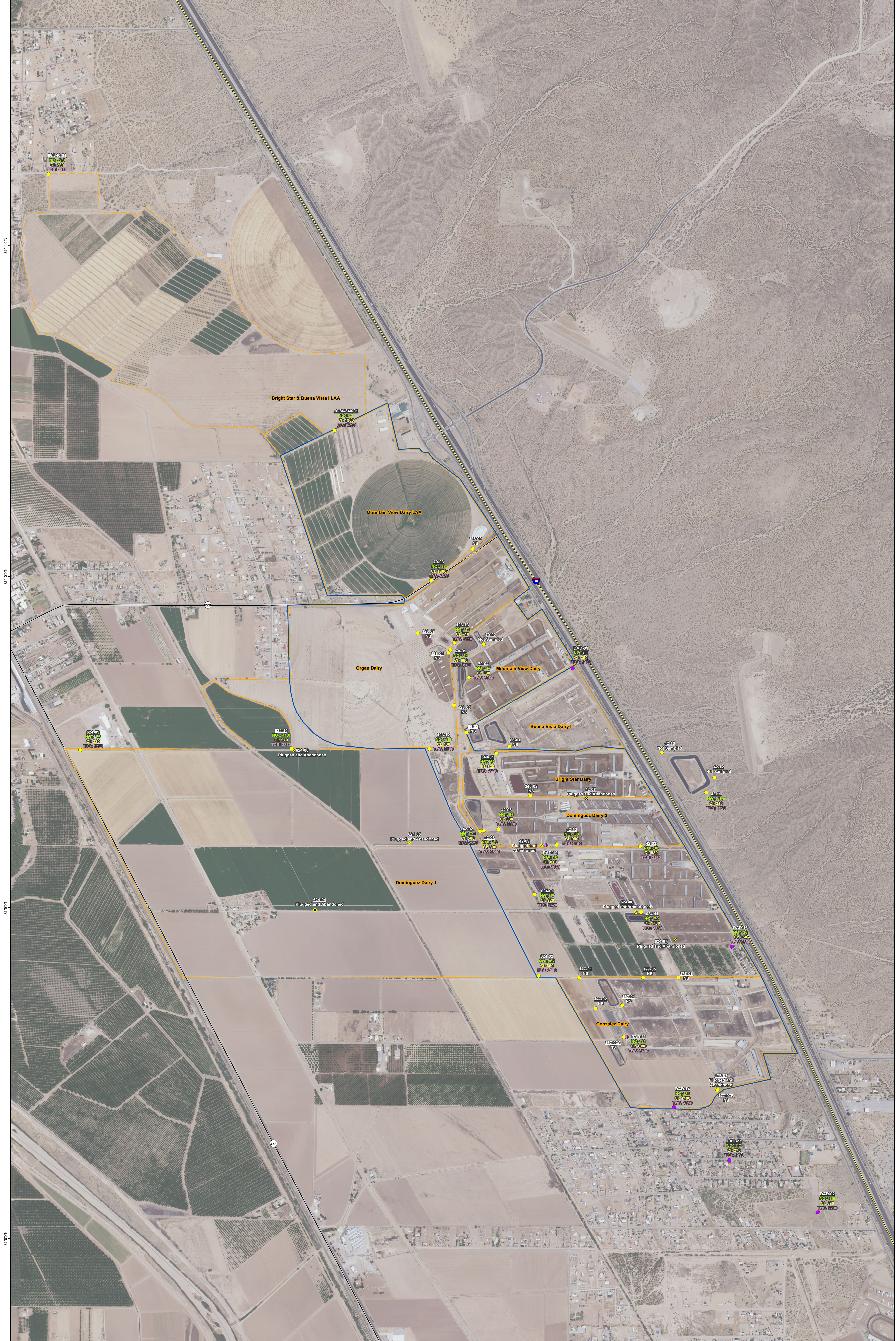

- LEGEND:**
- Abatement Plan Monitoring Well
 - Discharge Plan Monitoring Well
 - Discharge Plan Monitoring Well, Plugged and Abandoned or Destroyed
 - Abatement Plan Vertical Delineation Monitoring Well
 - Interstate Highway
 - State Highway
 - Other Road
 - ▭ Land Owned by Dairies
 - ▭ Land Application on Non-Dairy Property
 - ▭ Stage 2 Abatement Plan Area

Notes:
 Units are in milligrams per liter.
 Cl = Chloride
 LRG = Irrigation well
 NO₃ = Nitrate as N
 NS = Not Sampled
 TDS = Total Dissolved Solids

REFERENCES
 Roads: Dona Ana County, 2001
 Aerial Photography: NAIP, 2022
 Projection: State Plane NAD 83 New Mexico Central (feet)

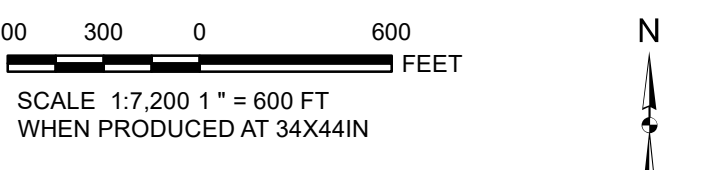

PROJECT: **DOÑA ANA DAIRIES MESQUITE, NEW MEXICO**

TITLE: **GROUNDWATER ANALYTICAL RESULTS NOVEMBER/DECEMBER 2023 NORTHERN PORTION**

DATE	BY	SCALE	REV
NOV 2023	EA	1/17,200	1
DEC 2023	EA	1/17,200	2
FIGURE 6			



- LEGEND:**
- Abatement Plan Monitoring Well
 - Abatement Plan Monitoring Well, Plugged and Abandoned
 - Discharge Plan Monitoring Well, Plugged and Abandoned
 - Abatement Plan Vertical Delineation Monitoring Well
 - Interstate Highway
 - State Highway
 - Other Road
 - ▭ Land Owned by Dairies
 - ▭ Land Application on Non-Dairy Property
 - ▭ Stage 2 Abatement Plan Area

Notes:
 Units are in milligrams per liter.
 Cl = Chloride
 LRG = Irrigation well
 NO₃ = Nitrate as N
 NS = Not Sampled
 TDS = Total Dissolved Solids

REFERENCES
 Roads: Dona Ana County, 2001
 Aerial Photography: NARS, 2022
 Projection: State Plane NAD 83 New Mexico Central (feet)

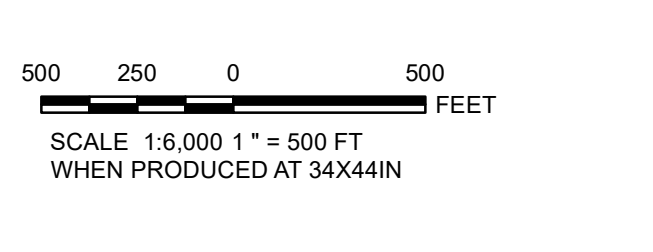

PROJECT: DOÑA ANA DAIRIES
 MESQUITE, NEW MEXICO

THE GROUNDWATER ANALYTICAL RESULTS
 NOVEMBER/DECEMBER 2023
 CENTRAL PORTION

PROJECT NO.	18-0001
DATE	11/2023
SCALE	1:6,000
PROJ. NO.	18-0001
REV.	01

FIGURE 7

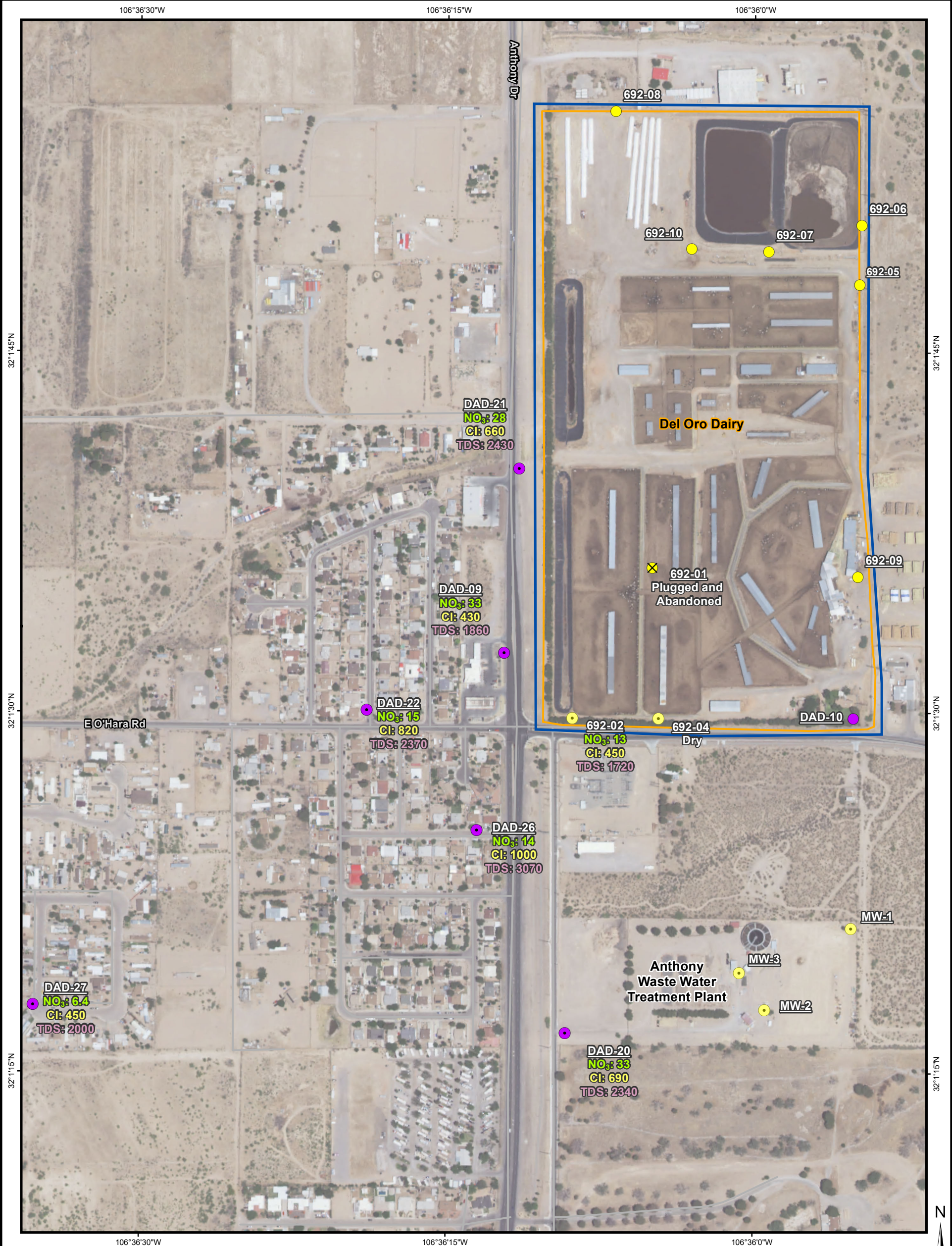

LEGEND:

- Perched Aquifer Monitoring Well**
 - Abatement Plan Monitoring Well
 - Discharge Plan Monitoring Well
 - ⊗ Discharge Plan Monitoring Well - Plugged and Abandoned
- Regional Aquifer Monitoring Well**
 - Abatement Plan Monitoring Well
 - Discharge Plan Monitoring Well
- ▭ Land Owned by Dairies
- ▭ Stage 2 Abatement Plan Area

Notes:
 Units are in milligrams per liter.
 Cl = Chloride
 LRG = irrigation well
 mg/L = Milligram(s) per liter
 NO₃ = Nitrate as N
 NS = Not sampled
 TDS = Total Dissolved Solids

REFERENCES
 Aerial Photography: NAIP, 2022
 Projection: State Plane NAD 83 New Mexico Central (feet)

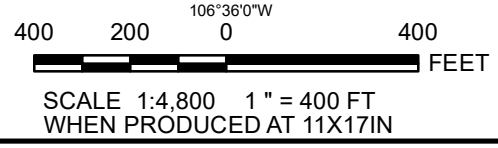

PROJECT			
DOÑA ANA DAIRIES MESQUITE, NEW MEXICO			
TITLE			
GROUNDWATER ANALYTICAL RESULTS NOVEMBER/DECEMBER 2023 SOUTHERN PORTION, PERCHED AQUIFER			
	PROJECT No. 21464112.04		SCALE AS SHOWN
	DESIGN	NA	
	GIS	RM	FIGURE 9
	CHECK		
REVIEW			

APPENDIX A

**DEL ORO DAIRY PUMP AND REUSE SYSTEM PERFORMANCE
ASSESSMENT**

APPENDIX A
PUMP AND REUSE SYSTEM PERFORMANCE ASSESSMENT
DEL ORO DAIRY, ANTHONY, NEW MEXICO
MARCH 2024

This quarterly performance assessment of the Del Oro Pump and Reuse System has been prepared in compliance with the Stage 2 Abatement Plan (S2AP) Modification Performance Plan (EA Engineering, Science, and Technology, Inc., PBC [EA] 2022). Note that references are included in the main document text.

The performance assessment evaluates pumping rates, total volume pumped, mass removed, and plume capture by the five extraction wells installed along the downgradient perimeter of the Del Oro Dairy property. A site background summary is included in the main report.

Pump and Reuse System

The pump and reuse system is shown in plan view on Figure A1. The system consists of:

- Five, 4-inch diameter groundwater extraction wells completed in the perched aquifer (EW-01 through EW-05). The submerged screens in each well were installed at 14 to 15 feet below the water table, representing the perched aquifer thickness (water table to confining clay).
- Five submersible solar groundwater pumps supplied by Rural Pumping Systems, complete with controllers and 4 x 100-Watt (400 Watt total) solar panels installed at each well head.
- Well head completions consisting of valves, flow meters, sample ports, and steel pipe fence and bollards to isolate from cattle.
- Main conveyance line consisting of 1.5-inch diameter high density polyethylene (HDPE) pipe connecting the extraction wells to HDPE storage tanks located at the milking parlor.
- Two 6,000 HDPE storage tanks plumbed in parallel.
- Transfer pump and pressure tank for delivery to the milking parlor.

A process flow diagram of the system is provided as Drawing P-1.

Quarterly Performance Assessment

Startup testing began in late December 2022 following pump and solar panel installation. After several iterations of trouble-shooting, all pumps were pumping at capacity by April 2023 except for extraction well EW-3. The pump in this well is not functioning properly; however, permeability at well EW-3 is an order of magnitude less than at the other wells; the well yield and mass removal are low as a result of the lower permeability. Its omission from the well network is not expected to negatively impact system efficacy. Del Oro Dairy performs weekly meter reading and relays data to EA for record keeping and reporting.

Performance assessment will be used to evaluate average pumping rates, mass removal of nitrate, and plume capture by the five extraction wells. The performance assessment consists of three components: 1) tracking and reporting of extracted groundwater volume, 2) collection of groundwater samples from extraction wells and analysis of mass removal, and 3) capture analysis.

Extracted Groundwater Volume

Totalizing flow meters measure the volume of extracted groundwater from each extraction well as reported in Table A1. The aggregate volume of water pumped from the five wells is also measured at the storage tanks with a totalizing meter located just before outfall into the storage tanks. Weekly liquid depth measurements for the Del Oro lagoon cells (ultimate destination of extraction water) are provided in Attachment 1. Stable liquid levels in the lagoon cells indicate that extracted groundwater that is used to wash down the milking parlor and then transported to the lagoons for disposal does not exceed the capacity of the lagoons.

Groundwater Sampling Results and Nitrate Mass Removal

Groundwater samples are collected from each extraction well quarterly on the abatement plan monitoring schedule. Analytical results for extraction well samples collected in November and December 2023 are provided in Table A2 and laboratory reports are provided in Attachment 2.

Since system startup in December 2022 nitrate concentrations have decreased in well EW-02 and EW-04 and increased in EW-01 and EW-05. Nitrate concentrations initially increased in EW-01 but have been relatively stable since May 2023. EW-03 is less transmissive than the other extraction wells and was not sampled. Chloride has remained relatively steady since startup in well EW-01 and increased in EW-02, EW-03 and EW-04. Since system startup, TDS concentrations in the extraction wells have decreased in all extraction wells except for EW-05 which had a slight increase. The highest nitrate concentration was detected in EW-01 with a concentration of 190 mg/L. The highest concentrations of chloride and TDS were also detected in EW-01 with concentrations of 1,100 mg/L and 4,340 mg/L, respectively.

Nitrate mass removal rates are the product of flow rate and chemical concentrations, which yield total mass removed per quarter. The nitrate mass removed this quarter was 257.4 pounds. Cumulative mass removed since startup is 1,151.8 pounds. A summary of nitrate mass removal is provided in Table A3.

Capture Analysis

Capture analysis is a function of flow rate, permeability (hydraulic conductivity), and hydraulic gradient. Flow rates are measured weekly via flow meters, and hydraulic gradient is calculated from quarterly water level measurements. Hydraulic conductivity for the perched aquifer was estimated based on observed grain size and typical values. For fine to medium sand, 10^{-2} to 10^{-3} centimeters per second (cm/s) is typical, and this range equates to 27 to 2.7 feet per day (ft/day). Since the sand was logged as “poorly graded fine sand,” permeability was assigned as 10 ft/day in higher yielding wells EW-1, EW-2, EW-4, and EW-5, and 1 ft/day for low yielding well EW-3. Based on these permeabilities and measured flow rates and gradient, the estimated capture width for each well is

provided in Table A4. Nitrate, chloride, and total dissolved solids (TDS) concentration trends for downgradient and key monitoring wells are provided in Attachment 3.

Attachments: Figure A1 – Extraction System Layout
Drawing P-1 – Process Flow Diagram
Table A1 – Pumping Volume and Rates
Table A2 – Extraction Well Groundwater Analytical Results
Table A3 – Summary of Nitrate Mass Removal
Table A4 – Capture Analysis for Pumping Wells
Attachment 1 – Weekly Liquid Depth Measurements for Lagoons
Attachment 2 – Analytical Laboratory Reports
Attachment 3 – Concentration Trends for Del Oro Extraction Wells and Abatement
Plan Monitoring Wells in the Perched Aquifer

FIGURE A1 and DRAWING P-1

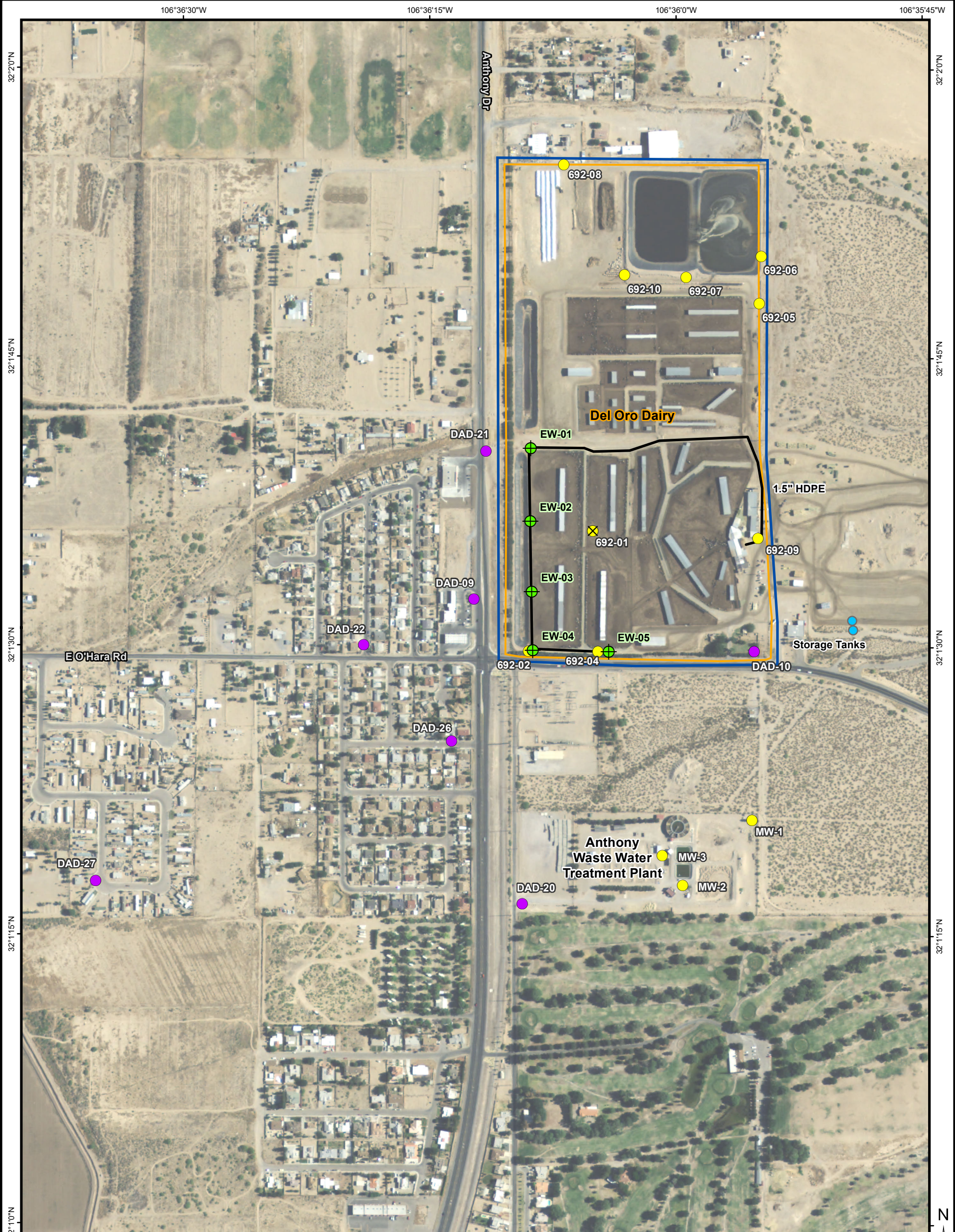

LEGEND:

- Extraction Well
- Conveyance Line
- Perched Aquifer Monitoring Well**
- Abatement Plan Monitoring Well
- Discharge Plan Monitoring Well
- Discharge Plan Monitoring Well - Plugged and Abandoned
- Regional Aquifer Monitoring Well**
- Abatement Plan Monitoring Well
- Discharge Plan Monitoring Well
- Land Owned by Dairies
- Stage 2 Abatement Plan Area

REFERENCES
 Aerial Photography: NAIP, 2011
 PLSS: BLM, 2000
 Projection: State Plane NAD 83 New Mexico Central (feet)

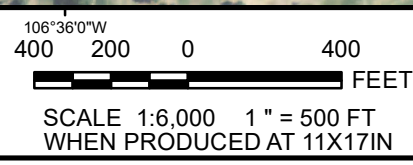

PROJECT		DOÑA ANA DAIRIES MESQUITE, NEW MEXICO	
TITLE		EXTRACTION SYSTEM LAYOUT DEL ORO DAIRY	
	PROJECT No.	21464112.03	
	DESIGN	NA	SCALE AS SHOWN
	GIS	RM	REV 0
	CHECK		FIGURE A1
REVIEW			

P:\Active Projects\Documents\Del Oro\Figures Vener Mustafin 2/10/23 10:46 AM C:\Users\vmustafin\OneDrive - EA Engineering, Science, and Technology, Inc.\PBC\Documents\Work\Domestic\Del Oro.dwg

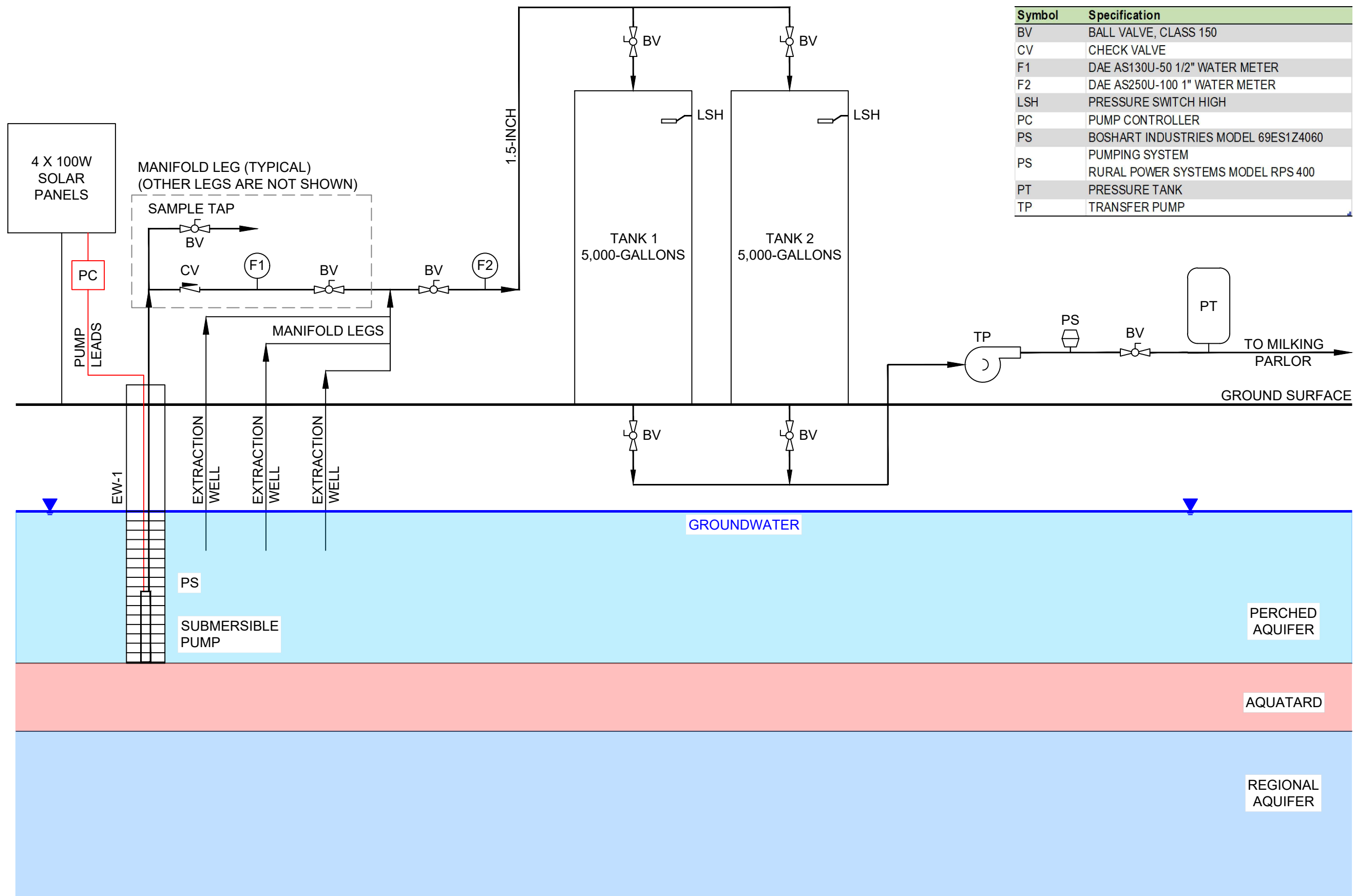

Symbol	Specification
BV	BALL VALVE, CLASS 150
CV	CHECK VALVE
F1	DAE AS130U-50 1/2" WATER METER
F2	DAE AS250U-100 1" WATER METER
LSH	PRESSURE SWITCH HIGH
PC	PUMP CONTROLLER
PS	BOSHART INDUSTRIES MODEL 69ES1Z4060
PS	PUMPING SYSTEM
PS	RURAL POWER SYSTEMS MODEL RPS 400
PT	PRESSURE TANK
TP	TRANSFER PUMP

320 GOLD AVENUE, SW SUITE 1300 ALBUQUERQUE, NM, 87102 505-224-9013, HTTPS://EAST.COM				
EA ENGINEERING, SCIENCE, AND TECHNOLOGY, INC.				
DESIGNED BY: JS	CHECKED BY: JS			
DRAWN BY: VM				
CHECKED BY: JS				
DE LO RO DAIRY, ANTHONY, NEW MEXICO STAGE 2 ABATEMENT PLAN MODIFICATION				
PROCESS FLOW DIAGRAM				
PROJECT NUMBER:	1464110-01			
DRAWING NO.:	P-1			
REV	DATE	DRAWN	CHECKED	REMARKS
0	2/10/23			
	2/10/23			

TABLES

(Provided in Electronic Format via CD Located on Front Cover of Report)

**TABLE A1. PUMPING VOLUMES AND RATES
DEL ORO DAIRY, ANTHONY, NEW MEXICO**

Date	Time	Elapsed Time (min)	EW-1 ¹	Q _{ave} ²	EW-2 ¹	Q _{ave} ²	EW-3 ¹	Q _{ave} ²	EW-4 ¹	Q _{ave} ²	EW-5 ¹	Q _{ave} ²	Tank ¹	Q _{ave} ²
12/22/2022	12:45:00 PM	--	13,504		13,740		6750		6,203		12,120		31,259	
1/3/2023	7:30:00 AM	16,980	21,885	0.49	24,744	0.65	0.0	0.0	7,280	0.06	16,337	0.25	54,046	1.34
1/9/2023	7:30:00 AM	8,640	27,541	0.65	33,425	1.00	0.0	0.0	8,274	0.12	21,870	0.64	73,388	2.24
1/13/2023	10:00:00 AM	5,910	31,657	0.70	40,030	1.12	0.0	0.0	8,792	0.09	25,957	0.69	87,851	2.45
1/16/2023	2:00:00 PM	4,560	33,565	0.42	42,838	0.62	0.0	0.0	9,047	0.06	27,529	0.34	94,214	1.40
1/23/2023	11:00:00 AM	9,900	38,695	0.52	51,625	0.89	0.0	0.0	9,470	0.04	32,586	0.51	116,170	2.22
1/30/2023	9:00:00 AM	9,960	40,325	0.16	63,627	1.21	0.0	0.0	9,471	0.00	38,804	0.62	138,126	2.20
2/6/2023	9:30:00 AM	10,110	41,955	0.16	75,629	1.19	0.0	0.0	9,471	0.00	43,822	0.50	160,082	2.17
2/13/2023	9:00:00 AM	10,050	43,585	0.16	87,631	1.19	0.0	0.0	9,471	0.00	49,440	0.56	182,038	2.18
2/20/2023	2:00:00 PM	10,380	44,562	0.09	95,584	0.77	0.0	0.0	9,645	0.02	49,841	0.04	193,391	1.09
2/27/2023	11:25:00 AM	9,925	46,355	0.18	105,471	1.00	1000	0.0	9,846	0.02	49,857	0.00	206,255	1.30
3/6/2023	11:30:00 AM	10,085	48,796	0.24	118,557	1.30	143	-0.08	10,002	0.02	53,215	0.33	223,524	1.71
3/13/2023	10:00:00 AM	9,990	50,472	0.17	129,962	1.14	143	0.0	10,020	0.00	53,300	0.01	240,794	1.73
3/20/2023	9:45:00 AM	10,065	50,472	0.00	141,036	1.10	143	0.0	16,435	0.64	58,117	0.48	264,263	2.33
3/27/2023	9:00:00 AM	10,035	50,472	0.00	152,111	1.10	143	0.0	22,850	0.64	62,929	0.48	287,733	2.34
4/3/2023	10:30:00 AM	10,170	50,472	0.00	165,216	1.29	689	0.05	31,638	0.86	64,978	0.20	316,928	2.87
4/10/2023	10:00:00 AM	10,050	58,791	0.83	177,767	1.25	1254	0.06	39,593	0.79	73,732	0.87	351,146	3.40
4/17/2023	9:00:00 AM	10,020	68,627	0.98	190,104	1.23	1750	0.05	47,154	0.75	80,639	0.69	386,386	3.52
4/24/2023	9:00:00 AM	10,080	72,167	0.35	202,937	1.27	1983	0.02	55,452	0.82	82,848	0.22	422,932	3.63
5/1/2023	10:30:00 AM	10,170	19,889	1.96	215,777	1.26	2143	0.02	63,694	0.81	86,694	0.38	461,244	3.77
5/8/2023	10:30:00 AM	10,080	31,596	1.16	227,871	1.20	2321	0.02	70,149	0.64	88,583	0.19	494,210	3.27
5/15/2023	10:00:00 AM	10,050	43,484	1.18	239,586	1.17	2445	0.01	76,270	0.61	89,708	0.11	525,635	3.13
5/22/2023	10:45:00 AM	10,125	55,372	1.17	251,186	1.15	2566	0.01	82,391	0.60	90,832	0.11	557,060	3.10
5/29/2023	9:30:00 AM	10,005	67,341	1.20	262,562	1.14	2587	0.00	86,327	0.39	90,992	0.02	584,871	2.78
6/5/2023	10:00:00 AM	10,110	80,923	1.34	275,163	1.25	2587	0.00	90,312	0.39	90,992	0.00	620,587	3.53
6/12/2023	10:00:00 AM	10,080	94,505	1.35	287,765	1.25	2587	0.00	94,307	0.40	90,992	0.00	656,304	3.54
6/19/2023	10:30:00 AM	10,110	108,529	1.39	300,599	1.27	2587	0.00	97,848	0.35	91,000	0.00	677,677	2.11
6/26/2023	10:00:00 AM	10,050	122,469	1.39	313,269	1.26	2682	0.01	100,849	0.30	95,708	0.47	711,332	3.35
7/3/2023	4:15:00 PM	10,455	136,750	1.37	325,789	1.20	2762	0.01	103,476	0.25	100,664	0.47	747,124	3.42
7/10/2023	11:00:00 AM	9,765	149,015	1.26	338,601	1.31	2763	0.00	106,104	0.27	105,013	0.45	779,317	3.30
7/17/2023	11:15:00 AM	10,095	161,422	1.23	351,058	1.23	2763	0.00	108,733	0.26	108,512	0.35	810,775	3.12
7/24/2023	10:30:00 AM	10,035	173,023	1.16	362,424	1.13	2763	0.00	110,821	0.21	110,867	0.23	838,842	2.80
7/31/2023	9:00:00 AM	9,990	185,966	1.30	375,764	1.34	2763	0.00	112,871	0.21	113,252	0.24	871,594	3.28
8/7/2023	9:30:00 AM	10,110	196,377	1.03	387,480	1.16	2763	0.00	114,375	0.15	115,067	0.18	898,842	2.70
8/14/2023	9:00:00 AM	10,050	206,788	1.04	399,197	1.17	2763	0.00	115,879	0.15	116,883	0.18	924,510	2.55
8/21/2023	10:00:00 AM	10,140	218,382	1.14	410,496	1.11	2763	0.00	117,872	0.20	118,646	0.17	951,852	2.70
8/28/2023	11:00:00 AM	10,140	229,976	1.14	421,795	1.11	2763	0.00	119,864	0.20	120,408	0.17	979,194	2.70
9/4/2023	11:00:00 AM	10,080	238,915	0.89	431,113	0.92	27630	2.47	121,161	0.13	121,510	0.11	1,000,406	2.10
9/11/2023	11:00:00 AM	10,080	248,779	0.98	441,603	1.04	27630	0.00	122,593	0.14	122,716	0.12	1,024,830	2.42
9/18/2023	11:00:00 AM	10,080	256,429	0.76	449,915	0.82	27630	0.00	123,623	0.10	123,424	0.07	1,044,326	1.93
9/25/2023	10:00:00 AM	10,020	263,900	0.75	459,188	0.93	27630	0.00	124,135	0.05	123,686	0.03	1,061,955	1.76
10/2/2023	11:00:00 AM	10,140	272,371	0.84	468,462	0.91	27630	0.00	124,648	0.05	123,949	0.03	1,079,584	1.74
10/9/2023	10:45:00 AM	10,065	277,842	0.54	477,735	0.92	27630	0.00	125,160	0.05	124,212	0.03	1,097,210	1.75
10/16/2023	10:30:00 AM	10,065	286,313	0.84	487,009	0.92	27630	0.00	125,623	0.05	124,476	0.03	1,114,830	1.75
10/23/2023	10:00:00 AM	10,050	293,785	0.74	496,283	0.92	27630	0.00	126,185	0.06	124,738	0.03	1,132,475	1.76
10/30/2023	10:00:00 AM	10,080	299,137	0.53	504,413	0.81	27630	0.00	126,250	0.01	124,835	0.01	1,146,027	1.34
11/6/2023	11:00:00 AM	10,140	304,490	0.53	511,972	0.75	27630	0.00	126,315	0.01	124,835	0.00	1,159,579	1.34
11/13/2023	11:00:00 AM	10,080	307,764	0.32	517,341	0.53	27630	0.00	126,328	0.00	124,838	0.00	1,167,402	0.78
11/20/2023	11:00:00 AM	10,080	310,212	0.24	521,109	0.37	27630	0.00	126,355	0.00	124,846	0.00	1,175,301	0.78
11/27/2023	2:15:00 PM	10,275	313,486	0.32	526,479	0.52	27630	0.00	126,367	0.00	124,849	0.00	1,183,162	0.77
12/4/2023	2:00:00 PM	10,065	316,812	0.33	531,054	0.45	27630	0.00	126,375	0.00	124,849	0.00	1,190,950	0.77

Notes:

¹ Meter readings in total gallons

² Q_{avg} Average discharge in gallons per minute (total volume pumped [end meter - beginning meter] / time in pumping period (minutes)

Current pumping period

**TABLE A2. DEL ORO DAIRY EXTRACTION WELL ANALYTICAL RESULTS
DONA ANA DAIRIES, DONA ANA COUNTY, NEW MEXICO**

Extraction Well	Date Sampled	Nitrate (mg/l)	TKN (mg/l)	Chloride (mg/l)	TDS (mg/l)
EW-01	12/4/2023	190	<0.50	1,100	4,340
	8/29/2023	180	<5.0	1,100	4,280
	5/19/2023	190	<1.0	1,100	4,220
	3/1/2023	130	<5.0	820	3,400
	10/27/2022	160	<5.0	1,100	4,490
EW-02	11/29/2023	130	<0.50	880	3,420
	8/30/2023	120	<5.0	810	3,340
	5/18/2023	130	<1.0	870	3,280
	3/1/2023	130	<5.0	820	3,190
	10/27/2022	150	<5.0	950	3,910
EW-03	11/29/2023	Not Sampled			
	8/30/2023				
	5/18/2023				
	2/27/2023	74	<5.0	670	2,520
	10/27/2022	99	<5.0	710	3,180
EW-04	11/29/2023	16	1.1	410	1,470
	8/25/2023	29	<5.0	420	1,580
	5/18/2023	28	<5.0	410	1,510
	2/27/2023	20	<5.0	430	1,450
	10/27/2022	25	<5.0	390	1,510
EW-05	11/29/2023	20	<0.50	490	1,820
	8/25/2023	14	<2.0	450	1,750
	5/18/2023	17	<2.0	490	1,820
	3/15/2023	15	14	510	1,800
	10/27/2022	12	<2.0	410	1,800
NMWQCC Standard		10	NA	250	1,000
Existing Conditions		NA	NA	455	1,424
NOTES:					
* = Pre-August 2020 existing conditions were in place prior to August 2020. This condition is no longer applicable.					
NMWQCC = New Mexico Water Quality Control Commission					
TDS = Total dissolved solids					
TKN = Total Kjeldahl Nitrogen					
Data from current quarter.					
Highlight is at or above NMWQCC Standard.					
Highlight is at or above relevant existing conditions value. Applicable to samples collected in or after August 2020.					

**TABLE A3. SUMMARY OF NITRATE MASS REMOVAL
DEL ORO DAIRY, ANTHONY, NEW MEXICO**

Sampling Date	Pumping Period Start	Pumping Period End	Days Pumping	EW-1			EW-2			EW-3			EW-4			EW-5			Total Mass This Period ³	Cumulative Mass Removed ⁴
				Q _{avg} ¹	C ²	M _{total} ³	Q _{avg}	C	M _{total} ³	Q _{avg}	C	M _{total} ³	Q _{avg}	C	M _{total} ³	Q _{avg}	C	M _{total} ³		
3/1/2023	12/22/2023	2/27/2022	67	0.35	130	37.0	0.96	130	100.4	0	74	0.0	0.04	20	0.6	0.42	15	5.0	143.0	143.0
5/19/2023	3/6/2023	5/15/2023	79	0.62	190	109.5	1.21	130	145.1	0	NS	0.0	0.60	28	15.5	0.36	17	5.6	275.7	418.8
8/28/2023 - 8/30/23	5/22/2023	8/28/2023	98	1.23	180	279.4	1.20	120	182.1	0	NS	0.0	0.29	29	10.5	0.20	14	3.6	475.6	894.4
11/29/2023-12/4/2023	9/4/2023	12/4/2023	91	0.61	190	137.5	0.77	130	118.3	0	NS	0.0	0.05	16	0.9	0.03	20	0.7	257.4	1,151.8

Notes:

¹ Q_{avg} Average discharge gallons per minute (total volume pumped / time in pumping period (minutes))

² C Nitrate concentration milligrams per liter (mg/L)

³ M_{total} Total mass removed (pounds) this pumping period from all extraction wells

⁴ Cumulative mass of nitrate removed (pounds) since start of pumping

Data from current quarter

**TABLE A4. CAPTURE ANALYSIS FOR PUMPING WELLS
DEL ORO DAIRY, ANTHONY, NEW MEXICO**

Date	Hydraulic Gradient	EW-1		EW-2		EW-3		EW-4		EW-5	
		Q _{avg} ¹	Capture Width ²	Q _{avg} ¹	Capture Width ²	Q _{avg} ¹	Capture Width ²	Q _{avg} ¹	Capture Width ²	Q _{avg} ¹	Capture Width ²
4/17/2023	0.004	0.98	337	1.23	424	0.05	172	0.75	241	0.69	221
5/15/2023	0.003	0.62	286	1.21	555	0.00	0	0.60	257	0.36	154
8/28/2023	0.004	1.23	424	1.20	413	0.00	0	0.29	92	0.20	65
11/29/2023	0.004	0.61	211	0.77	266	0.00	0	0.05	15	0.03	10

Notes:

Transmissivity (ft²/day)

Well	K	b	T
EW-1	10	14	140
EW-2	10	14	140
EW-3	1	14	14
EW-4	10	15	150
EW-5	10	15	150

1. Q (ft³/day) = [Q_{avg}/7.48]*1,440 minutes/day = Average pumping rate this reporting period (gpm) divided by 7.48 gallons per cubic foot water times 1,440 minutes per day

2. Capture Width = $Q/(Ti)$ (Todd, David Keith 1980. Groundwater Hydrology, 2nd Edition. John Wiley and Sons.)

T = transmissivity (ft²/day)

K = hydraulic conductivity (ft/day)

b = aquifer thickness ≈ screen submergence (ft)

Data from current quarter

ATTACHMENTS

**ATTACHMENT 1 – WEEKLY LIQUID DEPTH MEASUREMENTS FOR
LAGOONS**

**CAFO Weekly Storage and Containment Structure Inspections
Log Sheet**

Facility Name: Del Oro Dairy NPDES Permit No.: NMG010026

Storage or Containment Structure: Evaporative Pond (Instructions on back)

Week	Date	Initials	Depth Marker Reading	Notes
Week 1	1-2-24	ER	9-	
Week 2	1-9-24	ER	9-	
Week 3	1-16-24	ER	9-	
Week 4	1-23-24	ER	9-	
Week 5	1-30-24	ER	9-	
Week 6	2-6-24	ER	9-	
Week 7	2-12-24	ER	9-	
Week 8				
Week 9				
Week 10				
Week 11				
Week 12				
Week 13				
Week 14				
Week 15				
Week 16				
Week 17				
Week 18				
Week 19				
Week 20				
Week 21				
Week 22				
Week 23				
Week 24				
Week 25				
Week 26				
Week 27				
Week 28				
Week 29				
Week 30				
Week 31				
Week 32				
Week 33				
Week 34				
Week 35				
Week 36				
Week 37				
Week 38				
Week 39				
Week 40				
Week 41				
Week 42				
Week 43				
Week 44				
Week 45				
Week 46				
Week 47				
Week 48				
Week 49				
Week 50				
Week 51				
Week 52				

CAFO Weekly Storage and Containment Structure Inspections
Log Sheet

NPDES Permit No: NMG010026
(Instructions on back)

Facility Name: Del Oro Dairy

Storage or Containment Structure: Evaporative Pond

Week	Date	Initials	Depth Marker Reading	Notes
Week 1	1-2-24	ER	6-	
Week 2	1-9-24	ER	6-	
Week 3	1-16-24	ER	6-	
Week 4	1-23-24	ER	6-	
Week 5	1-30-24	ER	6-	
Week 6	2/6-24	ER	6-	
Week 7	2/12/24	ER	6-	
Week 8				
Week 9				
Week 10				
Week 11				
Week 12				
Week 13				
Week 14				
Week 15				
Week 16				
Week 17				
Week 18				
Week 19				
Week 20				
Week 21				
Week 22				
Week 23				
Week 24				
Week 25				
Week 26				
Week 27				
Week 28				
Week 29				
Week 30				
Week 31				
Week 32				
Week 33				
Week 34				
Week 35				
Week 36				
Week 37				
Week 38				
Week 39				
Week 40				
Week 41				
Week 42				
Week 43				
Week 44				
Week 45				
Week 46				
Week 47				
Week 48				
Week 49				
Week 50				
Week 51				
Week 52				

**CAFO Weekly Storage and Containment Structure Inspections
Log Sheet**

Facility Name: Del Oro Dairy NRDES Permit No.: NMG010026
 Storage or Containment Structure: Runoff Pond (WRP-C) (Instructions on back)

20'

Week	Date	Initials	Depth Marker Reading	Notes	Date Corrected
Week 1	1-2-24	ER	0		
Week 2	1-9-24	ER	0		
Week 3	1-16-24	ER	0		
Week 4	1-23-24	ER	0		
Week 5	1-30-24	ER	0		
Week 6	2/6/24	ER	0		
Week 7	2/12/24	ER	0		
Week 8					
Week 9					
Week 10					
Week 11					
Week 12					
Week 13					
Week 14					
Week 15					
Week 16					
Week 17					
Week 18					
Week 19					
Week 20					
Week 21					
Week 22					
Week 23					
Week 24					
Week 25					
Week 26					
Week 27					
Week 28					
Week 29					
Week 30					
Week 31					
Week 32					
Week 33					
Week 34					
Week 35					
Week 36					
Week 37					
Week 38					
Week 39					
Week 40					
Week 41					
Week 42					
Week 43					
Week 44					
Week 45					
Week 46					
Week 47					
Week 48					
Week 49					
Week 50					
Week 51					
Week 52					

**CAFO Weekly Storage and Containment Structure Inspections
Log Sheet**

Facility Name: Del Oro Dairy NPDES Permit No.: NMG010026

Storage or Containment Structure: Runoff Pond (WRP-D) (Instructions on back)

Week	Date	Initials	Depth Marker Reading	Notes	Da Corr
Week 1	1-2-24	ER	0		
Week 2	1-9-24	ER	0		
Week 3	1-16-24	ER	0		
Week 4	1-23-24	ER	0		
Week 5	1-30-24	ER	0		
Week 6	2/6/24	ER	0		
Week 7	2/12/24	ER	0		
Week 8					
Week 9					
Week 10					
Week 11					
Week 12					
Week 13					
Week 14					
Week 15					
Week 16					
Week 17					
Week 18					
Week 19					
Week 20					
Week 21					
Week 22					
Week 23					
Week 24					
Week 25					
Week 26					
Week 27					
Week 28					
Week 29					
Week 30					
Week 31					
Week 32					
Week 33					
Week 34					
Week 35					
Week 36					
Week 37					
Week 38					
Week 39					
Week 40					
Week 41					
Week 42					
Week 43					
Week 44					
Week 45					
Week 46					
Week 47					
Week 48					
Week 49					
Week 50					
Week 51					
Week 52					

ATTACHMENT 2 – ANALYTICAL LABORATORY REPORTS
(Provided in Electronic Format via CD Located on Front Cover of Report)

December 28, 2023

Regina Mullen
EA Engineering
320 Gold Ave SW Suite 1210
Albuquerque, NM 87102
TEL:
FAX:

RE: Del Oro Dairy

OrderNo.: 2311D94

Dear Regina Mullen:

Eurofins Environment Testing South Central, LLC received 4 sample(s) on 11/30/2023 for the analyses presented in the following report.

These were analyzed according to EPA procedures or equivalent. To access our accredited tests please go to www.hallenvironmental.com or the state specific web sites. In order to properly interpret your results, it is imperative that you review this report in its entirety. See the sample checklist and/or the Chain of Custody for information regarding the sample receipt temperature and preservation. Data qualifiers or a narrative will be provided if the sample analysis or analytical quality control parameters require a flag. When necessary, data qualifiers are provided on both the sample analysis report and the QC summary report, both sections should be reviewed. All samples are reported, as received, unless otherwise indicated. Lab measurement of analytes considered field parameters that require analysis within 15 minutes of sampling such as pH and residual chlorine are qualified as being analyzed outside of the recommended holding time.

Please do not hesitate to contact Eurofins Albuquerque for any additional information or clarifications.

ADHS Cert #AZ0682 -- NMED-DWB Cert #NM9425 -- NMED-Micro Cert #NM0901

Sincerely,



Andy Freeman
Laboratory Manager
4901 Hawkins NE
Albuquerque, NM 87109

Hall Environmental Analysis Laboratory, Inc.

Analytical Report

Lab Order 2311D94

Date Reported: 12/28/2023

CLIENT: EA Engineering

Client Sample ID: EW-05

Project: Del Oro Dairy

Collection Date: 11/29/2023 11:15:00 AM

Lab ID: 2311D94-001

Matrix: GROUNDWA

Received Date: 11/30/2023 9:05:00 AM

Analyses	Result	RL	Qual	Units	DF	Date Analyzed	Batch
EPA METHOD 300.0: ANIONS							Analyst: RBC
Chloride	490	50	*	mg/L	100	11/30/2023 6:14:27 PM	R101516
Nitrogen, Nitrite (As N)	ND	1.0		mg/L	10	11/30/2023 6:01:35 PM	R101516
Nitrogen, Nitrate (As N)	20	1.0	*	mg/L	10	11/30/2023 6:01:35 PM	R101516
Sulfate	260	5.0	*	mg/L	10	11/30/2023 6:01:35 PM	R101516
SM2540C MOD: TOTAL DISSOLVED SOLIDS							Analyst: KS
Total Dissolved Solids	1820	50.0	*	mg/L	1	12/7/2023 4:14:00 PM	79174
EPA 351.2: TKN							Analyst: DML
Nitrogen, Kjeldahl, Total	ND	0.50		mg/L	1	12/19/2023 4:38:31 PM	79480

Refer to the QC Summary report and sample login checklist for flagged QC data and preservation information.

Qualifiers:	*	Value exceeds Maximum Contaminant Level.	B	Analyte detected in the associated Method Blank
	D	Sample Diluted Due to Matrix	E	Above Quantitation Range/Estimated Value
	H	Holding times for preparation or analysis exceeded	J	Analyte detected below quantitation limits
	ND	Not Detected at the Reporting Limit	P	Sample pH Not In Range
	PQL	Practical Quantitative Limit	RL	Reporting Limit
	S	% Recovery outside of standard limits. If undiluted results may be estimated.		

Hall Environmental Analysis Laboratory, Inc.

Analytical Report

Lab Order 2311D94

Date Reported: 12/28/2023

CLIENT: EA Engineering

Client Sample ID: 692-02

Project: Del Oro Dairy

Collection Date: 11/29/2023 1:18:00 PM

Lab ID: 2311D94-002

Matrix: GROUNDWA

Received Date: 11/30/2023 9:05:00 AM

Analyses	Result	RL	Qual	Units	DF	Date Analyzed	Batch
EPA METHOD 300.0: ANIONS							Analyst: RBC
Chloride	450	50	*	mg/L	100	11/30/2023 6:40:11 PM	R101516
Nitrogen, Nitrite (As N)	ND	1.0		mg/L	10	11/30/2023 6:27:18 PM	R101516
Nitrogen, Nitrate (As N)	13	1.0	*	mg/L	10	11/30/2023 6:27:18 PM	R101516
Sulfate	250	5.0		mg/L	10	11/30/2023 6:27:18 PM	R101516
SM2540C MOD: TOTAL DISSOLVED SOLIDS							Analyst: KS
Total Dissolved Solids	1720	50.0	*	mg/L	1	12/7/2023 4:14:00 PM	79174
EPA 351.2: TKN							Analyst: DML
Nitrogen, Kjeldahl, Total	ND	0.50		mg/L	1	12/19/2023 4:40:01 PM	79480

Refer to the QC Summary report and sample login checklist for flagged QC data and preservation information.

Qualifiers:	*	Value exceeds Maximum Contaminant Level.	B	Analyte detected in the associated Method Blank
	D	Sample Diluted Due to Matrix	E	Above Quantitation Range/Estimated Value
	H	Holding times for preparation or analysis exceeded	J	Analyte detected below quantitation limits
	ND	Not Detected at the Reporting Limit	P	Sample pH Not In Range
	PQL	Practical Quantitative Limit	RL	Reporting Limit
	S	% Recovery outside of standard limits. If undiluted results may be estimated.		

Hall Environmental Analysis Laboratory, Inc.

Analytical Report

Lab Order 2311D94

Date Reported: 12/28/2023

CLIENT: EA Engineering

Client Sample ID: EW-04

Project: Del Oro Dairy

Collection Date: 11/29/2023 2:24:00 PM

Lab ID: 2311D94-003

Matrix: GROUNDWA

Received Date: 11/30/2023 9:05:00 AM

Analyses	Result	RL	Qual	Units	DF	Date Analyzed	Batch
EPA METHOD 300.0: ANIONS							Analyst: RBC
Chloride	410	50	*	mg/L	100	11/30/2023 7:05:53 PM	R101516
Nitrogen, Nitrite (As N)	ND	1.0		mg/L	10	11/30/2023 6:53:02 PM	R101516
Nitrogen, Nitrate (As N)	16	1.0	*	mg/L	10	11/30/2023 6:53:02 PM	R101516
Sulfate	210	5.0		mg/L	10	11/30/2023 6:53:02 PM	R101516
SM2540C MOD: TOTAL DISSOLVED SOLIDS							Analyst: KS
Total Dissolved Solids	1470	50.0	*	mg/L	1	12/7/2023 4:14:00 PM	79174
EPA 351.2: TKN							Analyst: DML
Nitrogen, Kjeldahl, Total	1.1	0.50		mg/L	1	12/19/2023 4:41:31 PM	79480

Refer to the QC Summary report and sample login checklist for flagged QC data and preservation information.

Qualifiers:	*	Value exceeds Maximum Contaminant Level.	B	Analyte detected in the associated Method Blank
	D	Sample Diluted Due to Matrix	E	Above Quantitation Range/Estimated Value
	H	Holding times for preparation or analysis exceeded	J	Analyte detected below quantitation limits
	ND	Not Detected at the Reporting Limit	P	Sample pH Not In Range
	PQL	Practical Quantitative Limit	RL	Reporting Limit
	S	% Recovery outside of standard limits. If undiluted results may be estimated.		

Hall Environmental Analysis Laboratory, Inc.

Analytical Report

Lab Order 2311D94

Date Reported: 12/28/2023

CLIENT: EA Engineering

Client Sample ID: EW-02

Project: Del Oro Dairy

Collection Date: 11/29/2023 4:20:00 PM

Lab ID: 2311D94-004

Matrix: GROUNDWA

Received Date: 11/30/2023 9:05:00 AM

Analyses	Result	RL	Qual	Units	DF	Date Analyzed	Batch
EPA METHOD 300.0: ANIONS							Analyst: RBC
Chloride	880	50	*	mg/L	100	11/30/2023 7:31:36 PM	R101516
Nitrogen, Nitrite (As N)	ND	1.0		mg/L	10	11/30/2023 7:18:45 PM	R101516
Nitrogen, Nitrate (As N)	130	10	*	mg/L	100	11/30/2023 7:31:36 PM	R101516
Sulfate	500	50	*	mg/L	100	11/30/2023 7:31:36 PM	R101516
SM2540C MOD: TOTAL DISSOLVED SOLIDS							Analyst: KS
Total Dissolved Solids	3420	50.0	*	mg/L	1	12/7/2023 4:14:00 PM	79174
EPA 351.2: TKN							Analyst: DML
Nitrogen, Kjeldahl, Total	ND	0.50		mg/L	1	12/19/2023 4:43:01 PM	79480

Refer to the QC Summary report and sample login checklist for flagged QC data and preservation information.

Qualifiers:	*	Value exceeds Maximum Contaminant Level.	B	Analyte detected in the associated Method Blank
	D	Sample Diluted Due to Matrix	E	Above Quantitation Range/Estimated Value
	H	Holding times for preparation or analysis exceeded	J	Analyte detected below quantitation limits
	ND	Not Detected at the Reporting Limit	P	Sample pH Not In Range
	PQL	Practical Quantitative Limit	RL	Reporting Limit
	S	% Recovery outside of standard limits. If undiluted results may be estimated.		

QC SUMMARY REPORT

Hall Environmental Analysis Laboratory, Inc.

WO#: 2311D94

28-Dec-23

Client: EA Engineering
Project: Del Oro Dairy

Sample ID: MB	SampType: MBLK	TestCode: EPA Method 300.0: Anions								
Client ID: PBW	Batch ID: R101516	RunNo: 101516								
Prep Date:	Analysis Date: 11/30/2023	SeqNo: 3736673	Units: mg/L							
Analyte	Result	PQL	SPK value	SPK Ref Val	%REC	LowLimit	HighLimit	%RPD	RPDLimit	Qual
Chloride	ND	0.50								
Nitrogen, Nitrite (As N)	ND	0.10								
Nitrogen, Nitrate (As N)	ND	0.10								
Sulfate	ND	0.50								

Sample ID: LCS	SampType: LCS	TestCode: EPA Method 300.0: Anions								
Client ID: LCSW	Batch ID: R101516	RunNo: 101516								
Prep Date:	Analysis Date: 11/30/2023	SeqNo: 3736674	Units: mg/L							
Analyte	Result	PQL	SPK value	SPK Ref Val	%REC	LowLimit	HighLimit	%RPD	RPDLimit	Qual
Chloride	4.7	0.50	5.000	0	94.3	90	110			
Nitrogen, Nitrite (As N)	0.96	0.10	1.000	0	96.3	90	110			
Nitrogen, Nitrate (As N)	2.4	0.10	2.500	0	97.7	90	110			
Sulfate	9.5	0.50	10.00	0	95.4	90	110			

Qualifiers:

- * Value exceeds Maximum Contaminant Level.
- D Sample Diluted Due to Matrix
- H Holding times for preparation or analysis exceeded
- ND Not Detected at the Reporting Limit
- PQL Practical Quantitative Limit
- S % Recovery outside of standard limits. If undiluted results may be estimated.
- B Analyte detected in the associated Method Blank
- E Above Quantitation Range/Estimated Value
- J Analyte detected below quantitation limits
- P Sample pH Not In Range
- RL Reporting Limit

QC SUMMARY REPORT

Hall Environmental Analysis Laboratory, Inc.

WO#: 2311D94

28-Dec-23

Client: EA Engineering
Project: Del Oro Dairy

Sample ID: MB-79174	SampType: MBLK	TestCode: SM2540C MOD: Total Dissolved Solids								
Client ID: PBW	Batch ID: 79174	RunNo: 101684								
Prep Date: 12/6/2023	Analysis Date: 12/7/2023	SeqNo: 3745622	Units: mg/L							
Analyte	Result	PQL	SPK value	SPK Ref Val	%REC	LowLimit	HighLimit	%RPD	RPDLimit	Qual
Total Dissolved Solids	ND	50.0								

Sample ID: LCS-79174	SampType: LCS	TestCode: SM2540C MOD: Total Dissolved Solids								
Client ID: LCSW	Batch ID: 79174	RunNo: 101684								
Prep Date: 12/6/2023	Analysis Date: 12/7/2023	SeqNo: 3745623	Units: mg/L							
Analyte	Result	PQL	SPK value	SPK Ref Val	%REC	LowLimit	HighLimit	%RPD	RPDLimit	Qual
Total Dissolved Solids	1070	50.0	1000	0	107	80	120			

Sample ID: 2311D94-001ADUP	SampType: DUP	TestCode: SM2540C MOD: Total Dissolved Solids								
Client ID: EW-05	Batch ID: 79174	RunNo: 101684								
Prep Date: 12/6/2023	Analysis Date: 12/7/2023	SeqNo: 3745625	Units: mg/L							
Analyte	Result	PQL	SPK value	SPK Ref Val	%REC	LowLimit	HighLimit	%RPD	RPDLimit	Qual
Total Dissolved Solids	1800	50.0						0.993	10	*

Qualifiers:

- | | |
|---|---|
| * Value exceeds Maximum Contaminant Level. | B Analyte detected in the associated Method Blank |
| D Sample Diluted Due to Matrix | E Above Quantitation Range/Estimated Value |
| H Holding times for preparation or analysis exceeded | J Analyte detected below quantitation limits |
| ND Not Detected at the Reporting Limit | P Sample pH Not In Range |
| PQL Practical Quantitative Limit | RL Reporting Limit |
| S % Recovery outside of standard limits. If undiluted results may be estimated. | |

QC SUMMARY REPORT

Hall Environmental Analysis Laboratory, Inc.

WO#: 2311D94

28-Dec-23

Client: EA Engineering
Project: Del Oro Dairy

Sample ID: MB-79480	SampType: MBLK	TestCode: EPA 351.2: TKN								
Client ID: PBW	Batch ID: 79480	RunNo: 101956								
Prep Date: 12/19/2023	Analysis Date: 12/19/2023	SeqNo: 3761847	Units: mg/L							
Analyte	Result	PQL	SPK value	SPK Ref Val	%REC	LowLimit	HighLimit	%RPD	RPDLimit	Qual
Nitrogen, Kjeldahl, Total	ND	0.50								

Sample ID: LCSLL-79480	SampType: LCSLL	TestCode: EPA 351.2: TKN								
Client ID: BatchQC	Batch ID: 79480	RunNo: 101956								
Prep Date: 12/19/2023	Analysis Date: 12/19/2023	SeqNo: 3761848	Units: mg/L							
Analyte	Result	PQL	SPK value	SPK Ref Val	%REC	LowLimit	HighLimit	%RPD	RPDLimit	Qual
Nitrogen, Kjeldahl, Total	0.48	0	0.5000	0	96.7	50	150			

Sample ID: LCS-79480	SampType: LCS	TestCode: EPA 351.2: TKN								
Client ID: LCSW	Batch ID: 79480	RunNo: 101956								
Prep Date: 12/19/2023	Analysis Date: 12/19/2023	SeqNo: 3761849	Units: mg/L							
Analyte	Result	PQL	SPK value	SPK Ref Val	%REC	LowLimit	HighLimit	%RPD	RPDLimit	Qual
Nitrogen, Kjeldahl, Total	9.8	0.50	10.00	0	97.6	90	110			

Qualifiers:

- | | |
|---|---|
| * Value exceeds Maximum Contaminant Level. | B Analyte detected in the associated Method Blank |
| D Sample Diluted Due to Matrix | E Above Quantitation Range/Estimated Value |
| H Holding times for preparation or analysis exceeded | J Analyte detected below quantitation limits |
| ND Not Detected at the Reporting Limit | P Sample pH Not In Range |
| PQL Practical Quantitative Limit | RL Reporting Limit |
| S % Recovery outside of standard limits. If undiluted results may be estimated. | |

Sample Log-In Check List

Client Name: **EA Engineering** Work Order Number: **2311D94** RcptNo: **1**

Received By: **Joseph Alderette** 11/30/2023 9:05:00 AM

Completed By: **Cheyenne Cason** 11/30/2023 9:39:13 AM

Reviewed By: **SCM 11/30/23**

[Handwritten initials]

Chain of Custody

1. Is Chain of Custody complete? Yes No Not Present

2. How was the sample delivered? FedEx

Log In

3. Was an attempt made to cool the samples? Yes No NA

4. Were all samples received at a temperature of >0° C to 6.0°C Yes No NA

5. Sample(s) in proper container(s)? Yes No

6. Sufficient sample volume for indicated test(s)? Yes No

7. Are samples (except VOA and ONG) properly preserved? Yes No

8. Was preservative added to bottles? Yes No NA

9. Received at least 1 vial with headspace <1/4" for AQ VOA? Yes No NA

10. Were any sample containers received broken? Yes No

11. Does paperwork match bottle labels? Yes No

(Note discrepancies on chain of custody)

12. Are matrices correctly identified on Chain of Custody? Yes No

13. Is it clear what analyses were requested? Yes No

14. Were all holding times able to be met? Yes No

(If no, notify customer for authorization.)

of preserved bottles checked for pH: 4
 (<2 or >12 unless noted)
 Adjusted? NO
 Checked by: ju 11/30/23

Special Handling (if applicable)

15. Was client notified of all discrepancies with this order? Yes No NA

Person Notified:	<input type="text"/>	Date:	<input type="text"/>
By Whom:	<input type="text"/>	Via:	<input type="checkbox"/> eMail <input type="checkbox"/> Phone <input type="checkbox"/> Fax <input type="checkbox"/> In Person
Regarding:	<input type="text"/>		
Client Instructions:	<input type="text"/>		

16. Additional remarks: Project name missing on COC. Mitzelers

17. Cooler Information

Cooler No	Temp °C	Condition	Seal Intact	Seal No	Seal Date	Signed By
1	0.9	Good	Not Present	Morty		

January 15, 2024

Regina Mullen
EA Engineering
320 Gold Ave SW Suite 1210
Albuquerque, NM 87102
TEL:
FAX:

RE: Del Oro Dairy

OrderNo.: 2312185

Dear Regina Mullen:

Eurofins Environment Testing South Central, LLC received 3 sample(s) on 12/5/2023 for the analyses presented in the following report.

These were analyzed according to EPA procedures or equivalent. To access our accredited tests please go to www.hallenvironmental.com or the state specific web sites. In order to properly interpret your results, it is imperative that you review this report in its entirety. See the sample checklist and/or the Chain of Custody for information regarding the sample receipt temperature and preservation. Data qualifiers or a narrative will be provided if the sample analysis or analytical quality control parameters require a flag. When necessary, data qualifiers are provided on both the sample analysis report and the QC summary report, both sections should be reviewed. All samples are reported, as received, unless otherwise indicated. Lab measurement of analytes considered field parameters that require analysis within 15 minutes of sampling such as pH and residual chlorine are qualified as being analyzed outside of the recommended holding time.

Please do not hesitate to contact Eurofins Albuquerque for any additional information or clarifications.

ADHS Cert #AZ0682 -- NMED-DWB Cert #NM9425 -- NMED-Micro Cert #NM0901

Sincerely,



Andy Freeman
Laboratory Manager
4901 Hawkins NE
Albuquerque, NM 87109

Hall Environmental Analysis Laboratory, Inc.

Analytical Report

Lab Order 2312185

Date Reported: 1/15/2024

CLIENT: EA Engineering

Client Sample ID: 692-09

Project: Del Oro Dairy

Collection Date: 12/4/2023 11:09:00 AM

Lab ID: 2312185-001

Matrix: GROUNDWA

Received Date: 12/5/2023 8:55:00 AM

Analyses	Result	RL	Qual	Units	DF	Date Analyzed	Batch
EPA METHOD 300.0: ANIONS							Analyst: SNS
Chloride	400	50	*	mg/L	100	12/5/2023 11:01:03 PM	A101631
Nitrogen, Nitrite (As N)	ND	1.0		mg/L	10	12/5/2023 10:22:28 PM	A101631
Nitrogen, Nitrate (As N)	3.4	1.0		mg/L	10	12/5/2023 10:22:28 PM	A101631
Sulfate	210	5.0		mg/L	10	12/5/2023 10:22:28 PM	A101631
SM2540C MOD: TOTAL DISSOLVED SOLIDS							Analyst: KS
Total Dissolved Solids	1410	50.0	*	mg/L	1	12/11/2023 8:16:00 AM	79267
EPA 351.2: TKN							Analyst: DML
Nitrogen, Kjeldahl, Total	ND	0.50		mg/L	1	12/29/2023 4:21:03 PM	79642

Refer to the QC Summary report and sample login checklist for flagged QC data and preservation information.

Qualifiers:	*	Value exceeds Maximum Contaminant Level.	B	Analyte detected in the associated Method Blank
	D	Sample Diluted Due to Matrix	E	Above Quantitation Range/Estimated Value
	H	Holding times for preparation or analysis exceeded	J	Analyte detected below quantitation limits
	ND	Not Detected at the Reporting Limit	P	Sample pH Not In Range
	PQL	Practical Quantitative Limit	RL	Reporting Limit
	S	% Recovery outside of standard limits. If undiluted results may be estimated.		

Hall Environmental Analysis Laboratory, Inc.

Analytical Report

Lab Order 2312185

Date Reported: 1/15/2024

CLIENT: EA Engineering

Client Sample ID: 692-08

Project: Del Oro Dairy

Collection Date: 12/4/2023 2:17:00 PM

Lab ID: 2312185-002

Matrix: GROUNDWA

Received Date: 12/5/2023 8:55:00 AM

Analyses	Result	RL	Qual	Units	DF	Date Analyzed	Batch
EPA METHOD 300.0: ANIONS							Analyst: SNS
Chloride	400	50	*	mg/L	100	12/5/2023 11:26:46 PM	A101631
Nitrogen, Nitrite (As N)	ND	1.0		mg/L	10	12/5/2023 11:13:54 PM	A101631
Nitrogen, Nitrate (As N)	3.1	1.0		mg/L	10	12/5/2023 11:13:54 PM	A101631
Sulfate	200	5.0		mg/L	10	12/5/2023 11:13:54 PM	A101631
SM2540C MOD: TOTAL DISSOLVED SOLIDS							Analyst: KS
Total Dissolved Solids	1380	50.0	*	mg/L	1	12/11/2023 8:16:00 AM	79267
EPA 351.2: TKN							Analyst: DML
Nitrogen, Kjeldahl, Total	ND	0.50		mg/L	1	12/29/2023 4:22:33 PM	79642

Refer to the QC Summary report and sample login checklist for flagged QC data and preservation information.

Qualifiers:	*	Value exceeds Maximum Contaminant Level.	B	Analyte detected in the associated Method Blank
	D	Sample Diluted Due to Matrix	E	Above Quantitation Range/Estimated Value
	H	Holding times for preparation or analysis exceeded	J	Analyte detected below quantitation limits
	ND	Not Detected at the Reporting Limit	P	Sample pH Not In Range
	PQL	Practical Quantitative Limit	RL	Reporting Limit
	S	% Recovery outside of standard limits. If undiluted results may be estimated.		

Hall Environmental Analysis Laboratory, Inc.

Analytical Report

Lab Order 2312185

Date Reported: 1/15/2024

CLIENT: EA Engineering

Client Sample ID: EW-01

Project: Del Oro Dairy

Collection Date: 12/4/2023 3:40:00 PM

Lab ID: 2312185-003

Matrix: GROUNDWA

Received Date: 12/5/2023 8:55:00 AM

Analyses	Result	RL	Qual	Units	DF	Date Analyzed	Batch
EPA METHOD 300.0: ANIONS							Analyst: SNS
Chloride	1100	50	*	mg/L	100	12/5/2023 11:52:29 PM	A101631
Nitrogen, Nitrite (As N)	ND	1.0		mg/L	10	12/5/2023 11:39:38 PM	A101631
Nitrogen, Nitrate (As N)	190	10	*	mg/L	100	12/5/2023 11:52:29 PM	A101631
Sulfate	660	50	*	mg/L	100	12/5/2023 11:52:29 PM	A101631
SM2540C MOD: TOTAL DISSOLVED SOLIDS							Analyst: KS
Total Dissolved Solids	4340	50.0	*	mg/L	1	12/11/2023 8:16:00 AM	79267
EPA 351.2: TKN							Analyst: DML
Nitrogen, Kjeldahl, Total	ND	0.50		mg/L	1	12/29/2023 4:31:52 PM	79642

Refer to the QC Summary report and sample login checklist for flagged QC data and preservation information.

Qualifiers:	*	Value exceeds Maximum Contaminant Level.	B	Analyte detected in the associated Method Blank
	D	Sample Diluted Due to Matrix	E	Above Quantitation Range/Estimated Value
	H	Holding times for preparation or analysis exceeded	J	Analyte detected below quantitation limits
	ND	Not Detected at the Reporting Limit	P	Sample pH Not In Range
	PQL	Practical Quantitative Limit	RL	Reporting Limit
	S	% Recovery outside of standard limits. If undiluted results may be estimated.		

QC SUMMARY REPORT

Hall Environmental Analysis Laboratory, Inc.

WO#: 2312185

15-Jan-24

Client: EA Engineering
Project: Del Oro Dairy

Sample ID: MB	SampType: MBLK	TestCode: EPA Method 300.0: Anions								
Client ID: PBW	Batch ID: A101631	RunNo: 101631								
Prep Date:	Analysis Date: 12/5/2023	SeqNo: 3743171			Units: mg/L					
Analyte	Result	PQL	SPK value	SPK Ref Val	%REC	LowLimit	HighLimit	%RPD	RPDLimit	Qual
Chloride	ND	0.50								
Nitrogen, Nitrite (As N)	ND	0.10								
Nitrogen, Nitrate (As N)	ND	0.10								
Sulfate	ND	0.50								

Sample ID: LCS	SampType: LCS	TestCode: EPA Method 300.0: Anions								
Client ID: LCSW	Batch ID: A101631	RunNo: 101631								
Prep Date:	Analysis Date: 12/5/2023	SeqNo: 3743172			Units: mg/L					
Analyte	Result	PQL	SPK value	SPK Ref Val	%REC	LowLimit	HighLimit	%RPD	RPDLimit	Qual
Chloride	4.7	0.50	5.000	0	94.9	90	110			
Nitrogen, Nitrite (As N)	0.98	0.10	1.000	0	97.6	90	110			
Nitrogen, Nitrate (As N)	2.5	0.10	2.500	0	99.3	90	110			
Sulfate	9.6	0.50	10.00	0	96.3	90	110			

Sample ID: 2312185-001AMS	SampType: MS	TestCode: EPA Method 300.0: Anions								
Client ID: 692-09	Batch ID: A101631	RunNo: 101631								
Prep Date:	Analysis Date: 12/5/2023	SeqNo: 3743176			Units: mg/L					
Analyte	Result	PQL	SPK value	SPK Ref Val	%REC	LowLimit	HighLimit	%RPD	RPDLimit	Qual
Nitrogen, Nitrite (As N)	10	1.0	10.00	0.2903	98.1	80	120			
Nitrogen, Nitrate (As N)	29	1.0	25.00	3.424	103	80	120			
Sulfate	320	5.0	100.0	209.2	108	80	120			

Sample ID: 2312185-001AMSD	SampType: MSD	TestCode: EPA Method 300.0: Anions								
Client ID: 692-09	Batch ID: A101631	RunNo: 101631								
Prep Date:	Analysis Date: 12/5/2023	SeqNo: 3743177			Units: mg/L					
Analyte	Result	PQL	SPK value	SPK Ref Val	%REC	LowLimit	HighLimit	%RPD	RPDLimit	Qual
Nitrogen, Nitrite (As N)	10	1.0	10.00	0.2903	96.6	80	120	1.46	20	
Nitrogen, Nitrate (As N)	29	1.0	25.00	3.424	100	80	120	1.85	20	
Sulfate	310	5.0	100.0	209.2	100	80	120	2.50	20	

Qualifiers:

- * Value exceeds Maximum Contaminant Level.
- D Sample Diluted Due to Matrix
- H Holding times for preparation or analysis exceeded
- ND Not Detected at the Reporting Limit
- PQL Practical Quantitative Limit
- S % Recovery outside of standard limits. If undiluted results may be estimated.
- B Analyte detected in the associated Method Blank
- E Above Quantitation Range/Estimated Value
- J Analyte detected below quantitation limits
- P Sample pH Not In Range
- RL Reporting Limit

QC SUMMARY REPORT

Hall Environmental Analysis Laboratory, Inc.

WO#: 2312185

15-Jan-24

Client: EA Engineering
Project: Del Oro Dairy

Sample ID: MB-79267	SampType: MBLK	TestCode: SM2540C MOD: Total Dissolved Solids								
Client ID: PBW	Batch ID: 79267	RunNo: 101728								
Prep Date: 12/9/2023	Analysis Date: 12/11/2023	SeqNo: 3748381	Units: mg/L							
Analyte	Result	PQL	SPK value	SPK Ref Val	%REC	LowLimit	HighLimit	%RPD	RPDLimit	Qual
Total Dissolved Solids	ND	50.0								

Sample ID: LCS-79267	SampType: LCS	TestCode: SM2540C MOD: Total Dissolved Solids								
Client ID: LCSW	Batch ID: 79267	RunNo: 101728								
Prep Date: 12/9/2023	Analysis Date: 12/11/2023	SeqNo: 3748382	Units: mg/L							
Analyte	Result	PQL	SPK value	SPK Ref Val	%REC	LowLimit	HighLimit	%RPD	RPDLimit	Qual
Total Dissolved Solids	998	50.0	1000	0	99.8	80	120			

Qualifiers:

- * Value exceeds Maximum Contaminant Level.
- D Sample Diluted Due to Matrix
- H Holding times for preparation or analysis exceeded
- ND Not Detected at the Reporting Limit
- PQL Practical Quantitative Limit
- S % Recovery outside of standard limits. If undiluted results may be estimated.
- B Analyte detected in the associated Method Blank
- E Above Quantitation Range/Estimated Value
- J Analyte detected below quantitation limits
- P Sample pH Not In Range
- RL Reporting Limit

QC SUMMARY REPORT

Hall Environmental Analysis Laboratory, Inc.

WO#: 2312185

15-Jan-24

Client: EA Engineering
Project: Del Oro Dairy

Sample ID: MB-79642	SampType: MBLK	TestCode: EPA 351.2: TKN								
Client ID: PBW	Batch ID: 79642	RunNo: 102166								
Prep Date: 12/28/2023	Analysis Date: 12/29/2023	SeqNo: 3771614	Units: mg/L							
Analyte	Result	PQL	SPK value	SPK Ref Val	%REC	LowLimit	HighLimit	%RPD	RPDLimit	Qual
Nitrogen, Kjeldahl, Total	ND	0.50								

Sample ID: LCSLL-79642	SampType: LCSLL	TestCode: EPA 351.2: TKN								
Client ID: BatchQC	Batch ID: 79642	RunNo: 102166								
Prep Date: 12/28/2023	Analysis Date: 12/29/2023	SeqNo: 3771615	Units: mg/L							
Analyte	Result	PQL	SPK value	SPK Ref Val	%REC	LowLimit	HighLimit	%RPD	RPDLimit	Qual
Nitrogen, Kjeldahl, Total	0.34	0	0.5000	0	68.9	50	150			

Sample ID: LCS-79642	SampType: LCS	TestCode: EPA 351.2: TKN								
Client ID: LCSW	Batch ID: 79642	RunNo: 102166								
Prep Date: 12/28/2023	Analysis Date: 12/29/2023	SeqNo: 3771616	Units: mg/L							
Analyte	Result	PQL	SPK value	SPK Ref Val	%REC	LowLimit	HighLimit	%RPD	RPDLimit	Qual
Nitrogen, Kjeldahl, Total	11	0.50	10.00	0	107	90	110			

Qualifiers:

- | | |
|---|---|
| * Value exceeds Maximum Contaminant Level. | B Analyte detected in the associated Method Blank |
| D Sample Diluted Due to Matrix | E Above Quantitation Range/Estimated Value |
| H Holding times for preparation or analysis exceeded | J Analyte detected below quantitation limits |
| ND Not Detected at the Reporting Limit | P Sample pH Not In Range |
| PQL Practical Quantitative Limit | RL Reporting Limit |
| S % Recovery outside of standard limits. If undiluted results may be estimated. | |

Client Name: EA Engineering Work Order Number: 2312185 RcptNo: 1

Received By: Juan Rojas 12/5/2023 8:55:00 AM *Juan Rojas*

Completed By: Cheyenne Cason 12/5/2023 9:47:57 AM *Cason*

Reviewed By: *JA 12-5-23*

Chain of Custody

1. Is Chain of Custody complete? Yes No Not Present
2. How was the sample delivered? FedEx

Log In

3. Was an attempt made to cool the samples? Yes No NA
4. Were all samples received at a temperature of >0° C to 6.0°C Yes No NA
5. Sample(s) in proper container(s)? Yes No Samples not frozen
6. Sufficient sample volume for indicated test(s)? Yes No
7. Are samples (except VOA and ONG) properly preserved? Yes No
8. Was preservative added to bottles? Yes No NA
9. Received at least 1 vial with headspace <1/4" for AQ VOA? Yes No NA
10. Were any sample containers received broken? Yes No
11. Does paperwork match bottle labels? Yes No
 (Note discrepancies on chain of custody)
12. Are matrices correctly identified on Chain of Custody? Yes No
13. Is it clear what analyses were requested? Yes No
14. Were all holding times able to be met? Yes No
 (If no, notify customer for authorization.)

of preserved bottles checked for pH: 3
 (2 or >12 unless noted)
 Adjusted? NO
 Checked by: m/12/5/23

Special Handling (if applicable)

15. Was client notified of all discrepancies with this order? Yes No NA

Person Notified: Date:

By Whom: Via: eMail Phone Fax In Person

Regarding:

Client Instructions:

16. Additional remarks:

17. Cooler Information

Cooler No	Temp °C	Condition	Seal Intact	Seal No	Seal Date	Signed By
1	-0.7	Good	Not Present	Yogi		

**ATTACHMENT 3 – CONCENTRATION TRENDS FOR DEL ORO
EXTRACTION WELLS AND ABATEMENT PLAN MONITORING WELLS
IN THE PERCHED AQUIFER**

**NITRATE CONCENTRATION TRENDS
DEL ORO EXTRACTION WELLS IN THE PERCHED AQUIFER
DONA ANA DAIRIES, DONA ANA COUNTY, NEW MEXICO**

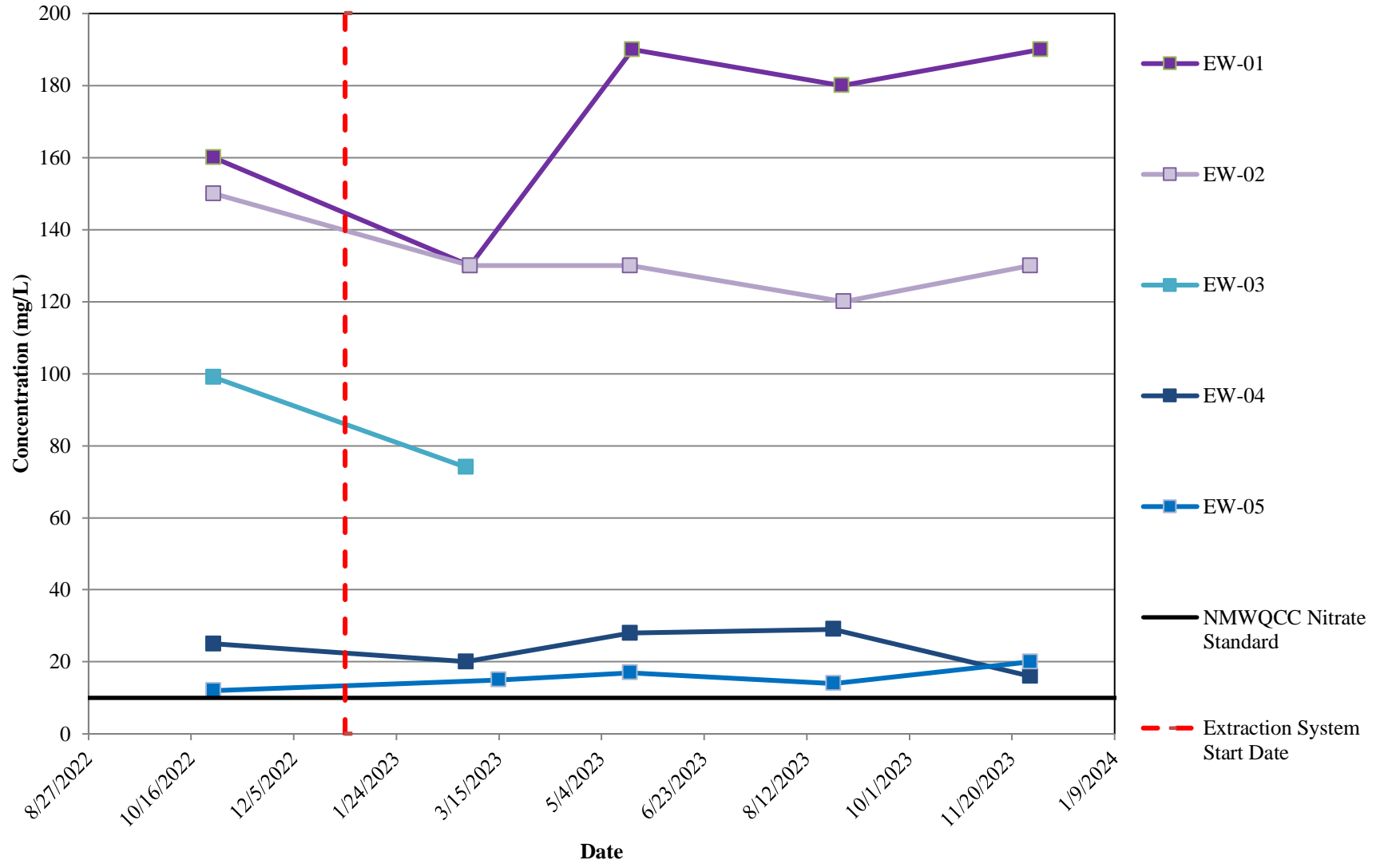

**CHLORIDE CONCENTRATION TRENDS
DEL ORO EXTRACTION IN THE PERCHED AQUIFER
DONA ANA DAIRIES, DONA ANA COUNTY, NEW MEXICO**

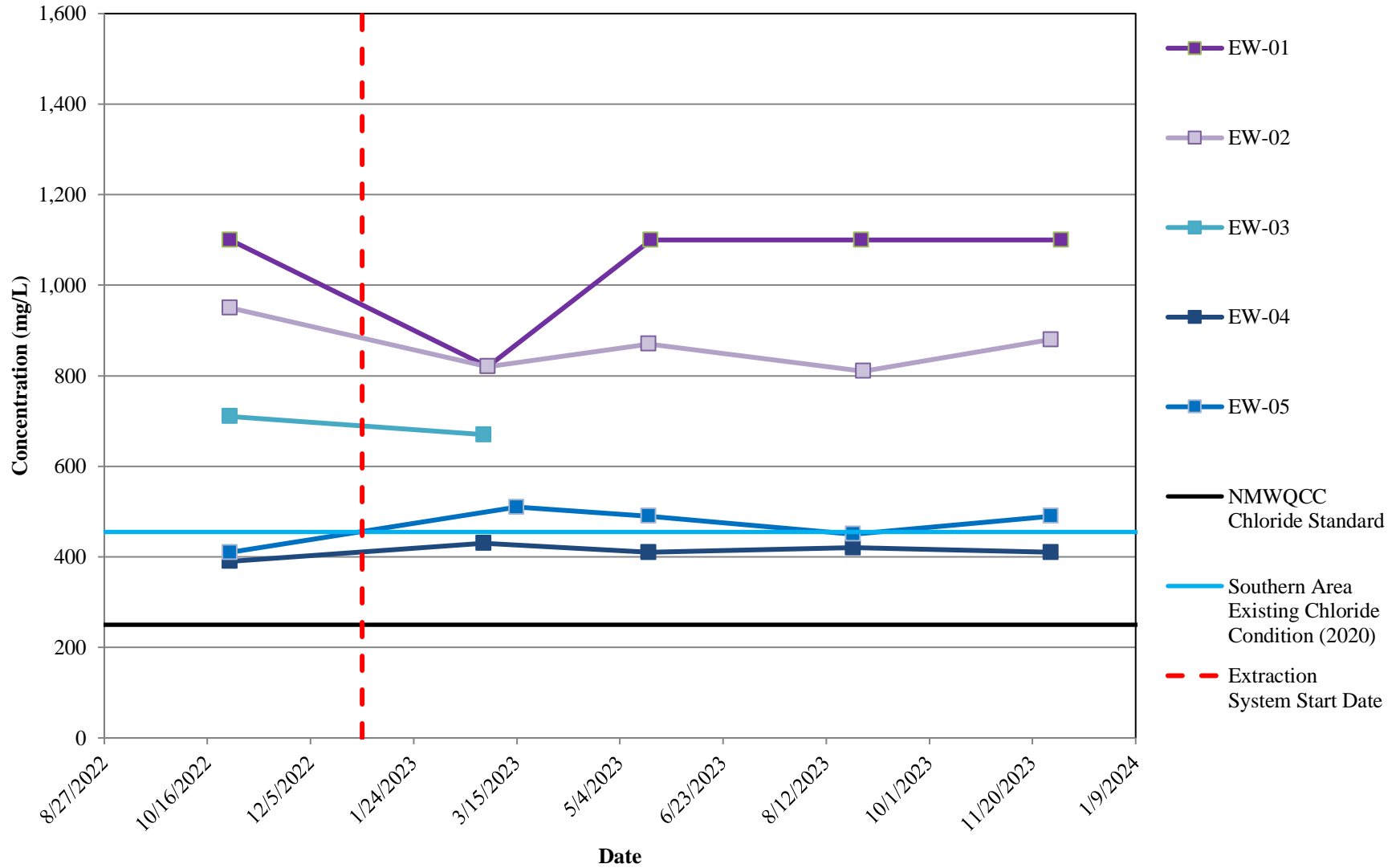

**TDS CONCENTRATION TRENDS
DEL ORO EXTRACTION WELLS IN THE PERCHED AQUIFER
DONA ANA DAIRIES, DONA ANA COUNTY, NEW MEXICO**

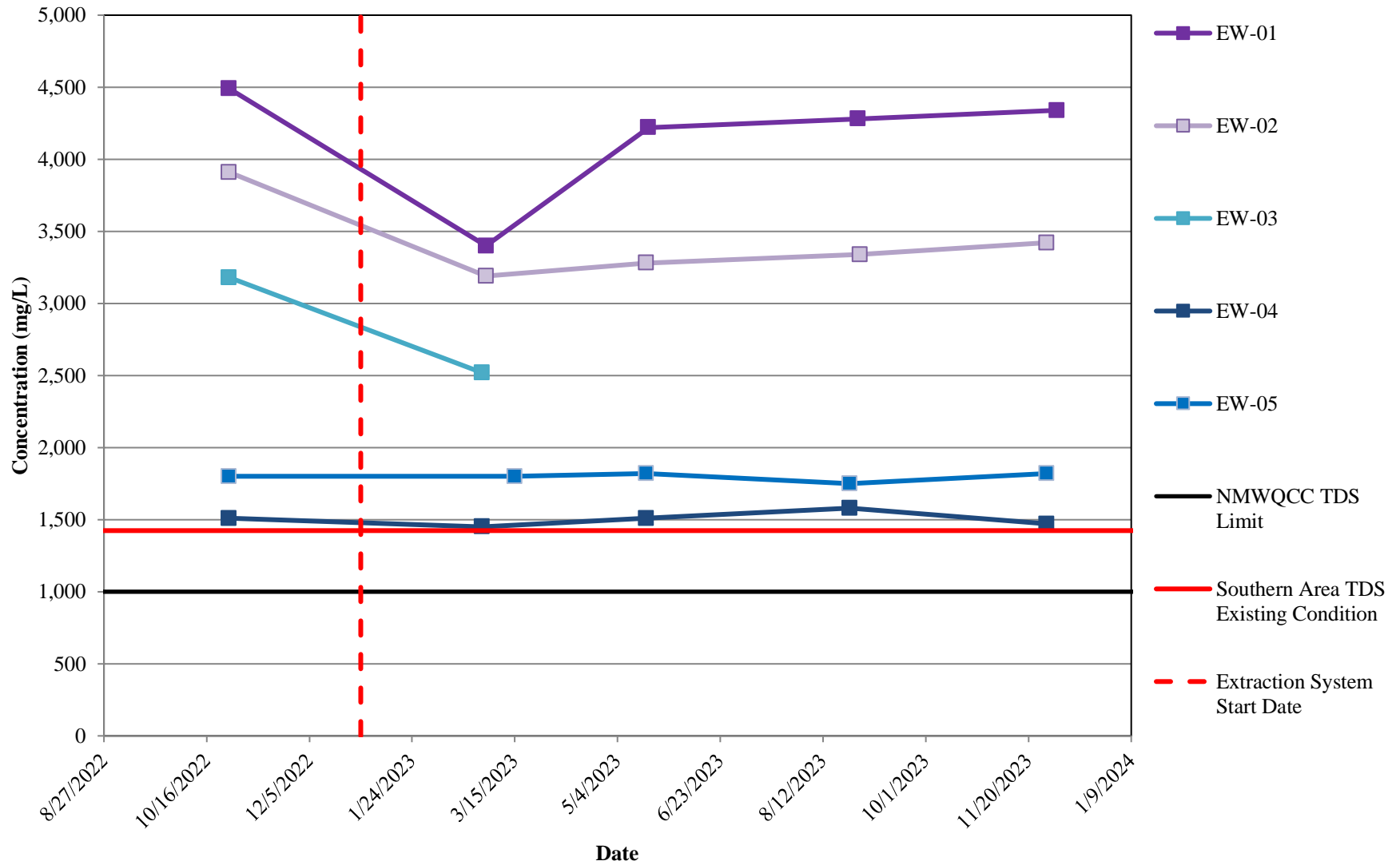

APPENDIX B

GAUGING AND SAMPLING FIELD FORMS

(Provided in Electronic Format via CD Located on Front Cover of Report)

**MONITORING WELL GAUGING DATA
DONA ANA DAIRIES, DONA ANA COUNTY, NEW MEXICO**

Monitoring Well	Northing ^a	Easting ^a	Date	Time	Depth to Water	Notes or Total Depth (ft)
NORTHERN AREA						
Northern Land Application Area (DP-340)						
70-03	424580.78	1510233.88	11-1-23	10:54	60.58	61.65
70/86/340-01	427320.92	1508461.05	11-1-23	10:28	54.48	67.94
86/340-01	432021.33	1503216.90	11-1-23	9:47	60.66	70.82
Mountain View Dairy (DP-70)						
70-01	423303.43	1510585.63	11-1-23	11:36	41.06	45.95
70-02	423412.73	1511192.51	11-1-23	11:58	49.62	49.83
70-04	422798.94	1510922.20	11-1-23	12:53	38.81	47.85
Buena Vista Dairy I (DP-86)						
86-01	421534.62	1511667.76	11-1-23	13:47	53.38	54.45
86-02	421792.08	1510881.53	11-1-23	13:20	35.00	48.44
Bright Star Dairy (DP-340)						
340-01	421410.13	1511423.42	11-1-23	14:03	46.70	48.25
340-02	420641.08	1512051.57	11-1-23	14:25	Dry	56.91
Dominguez 2 (DP-42)						
42-02	419982.45	1511126.19	11-2-23	11:10	31.15	65.30 Pump
42-03	419710.55	1514064.35	11-2-23	12:48	88.06	97.20 Pump
42-06	420021.61	1511465.15	11-2-23	11:40	37.54	41.55 Pump
42-07	420584.8	1513076.66	11-2-23			WELL REMOVED Pump
42-08	419994.93	1511197.91	11-2-23	11:20	33.63	35.10 Pump
42-09	419729.17	1512255.76	11-2-23			WELL REMOVED Pump
42-10	421426.39	1514460.4	11-2-23	10:51	120.03	123.60 Pump
42-11	420693.98	1515270.32	11-2-23	9:51	130.85	133.50 Pump
42-12	420972.09	1515423.88	11-2-23	10:17	137.16	139.44 Pump
42-13	419734.06	1512534.42	11-2-23	12:05	61.95	69.60 Pump
Dominguez Dairy (DP-624)						
624-01	418826.21	1512131.46	11-2-23	13:51	30.38	46.80
624-02	417335.25	1512201.42	11-2-23	13:57	22.11	37.43
624-09			11-2-23	15:39	26.20	32.80
624-10			11-2-23	15:08	27.30	37.33
624-11			11-2-23	13:46	56.40	68.89

**MONITORING WELL GAUGING DATA
DONA ANA DAIRIES, DONA ANA COUNTY, NEW MEXICO**

Monitoring Well	Northing*	Easting**	Date	Time	Depth to Water	Notes or Total Depth (ft)
CENTRAL AREA						
Buena Vista Dairy II (DP-74)						
74-01	405434.93	1519310.15	11-3-23	10:30	28.51	45.25
74-02	404574.08	1519035.52	11-3-23	10:22	18.80	20.25
74-03	407163.61	1516711.72	11-3-23	10:05	18.08	20.30
74-04	405488.65	1519864.48	11-3-23	10:47	50.67	57.89
74-05	404747.71	1519885.3	11-3-23	10:54	43.38	57.18
Big Sky Dairy (DP-833)						
833-02	401200.32	1520639.92	11-3-23	12:22	36.70	57.95
833-04	402898.52	1520659.33	11-3-23	12:10	44.90	53.33
833-05	399712.39	1522374.73	11-3-23	13:07	67.53	73.50
833-06	402219.48	1522652.04	11-3-23	11:55	76.50	85.25
833-07	399298.8	1522082.75	11-3-23	12:55	63.10	73.55
833-08	400535.64	1521938.23	11-3-23	12:46	62.74	73.27
833-09	398280.67	1520918.52	11-3-23	13:24	29.04	39.70
833-10	396715.89	1520283.6	11-3-23	13:35	23.57	37.72
Sunset/Desert Land Dairy (DP-257)						
257-01	395856.31	1520572.16	11-3-23	14:50	23.30	25.85
257-02	394728.34	1521030.29	11-3-23	14:59	17.00	20.86
257-03	397935.69	1518746.14	11-3-23	14:30	14.88	16.14
MW-4			11-3-23	15:50	33.32	39.95
Del Oro Dairy (DP-692)						
SOUTHERN AREA						
692-02	372984.72	1531192.1	11-6-23	10:37	59.65	66.15
692-04	372982.53	1531555.21	11-6-23	10:25	Dry	60.60
692-05	374807.26	1532403	11-6-23	10:57	82.73	87.50
692-06	375054.77	1532411.83	11-6-23	11:15	84.93	90.25
692-07	374944.88	1532019.81	11-6-23	11:31	76.61	77.70
692-08	375535.69	1531378.09	11-6-23	12:05	70.88	77.15
692-09	373575.83	1532395.09	11-6-23	10:49	86.07	91.10
692-10			11-6-23	11:50	75.90	77.90
EW-01						
EW-02						
EW-03						
EW-04						
EW-05						
Anthony Waste Water Treatment Plant						
MW-1	372097.86	1532364.36	11-6-23	15:13	65.30	79.95
MW-2	NM	NM	11-6-23	15:24	66.66	79.95
MW-3	NM	NM	11-6-23	15:46	59.13	78.43

**MONITORING WELL GAUGING DATA
DONA ANA DAIRIES, DONA ANA COUNTY, NEW MEXICO**

Monitoring Well	Northing ^a	Easting ^a	Date	Time	Depth to Water	Notes or Total Depth (ft)
ABATEMENT PLAN MONITOR WELLS						
DAD-01	422970.59	1512825.76	11-1-23	14:50	75.23	76.35
DAD-02	413002.98	1517319.93	11-3-23	9:17	68.11	68.45
DAD-03	407721.31	1516497.85	11-3-23	9:30	15.01	18.90
DAD-04	404576.66	1517413.28	11-3-23	9:58	18.25	18.73
DAD-05	396712.87	1519102.06	11-3-23	14:36	16.90	23.10
DAD-06R	404273.19	1522081.00	11-3-23	11:46	86.02	102.10
DAD-07	399270.18	1524320.88	11-3-23	15:34	93.47	100.65
DAD-08	395287.38	1522575.07	11-3-23	15:08	53.58	55.90
DAD-09	373259.30	1530905.70	11-3-23	13:20	57.00	61.25
DAD-10	372980.55	1532375.33	11-6-23	12:20	84.69	93.81
DAD-11	416211.35	1513814.71	11-2-23	14:50	24.12	47.55
DAD-12	419731.54	1512274.77	11-2-23	12:28	54.66	82.25
DAD-13	417879.08	1515673.13	11-2-23	14:38	88.95	92.78
DAD-14	414923.33	1514695.26	11-2-23	14:15	32.48	42.55
DAD-15	402001.22	1523552.04	11-3-23	11:20	97.05	109.90
DAD-16	400628.77	1519350.74	11-3-23	9:56	20.30	32.75
DAD-17	393991.97	1520267.94	11-3-23	14:15	21.46	38.89
DAD-18	395714.14	1520588.96	11-3-23	14:55	24.70	57.15
DAD-19	400164.47	1522027.92	11-3-23	13:18	66.12	99.35
DAD-20	371751.45	1531188.19	11-6-23	14:50	58.41	68.85
DAD-21	374013.39	1530983.98	11-6-23	13:10	58.88	66.53
DAD-22	373029.62	1530352.69	11-6-23	13:20	46.91	50.05
DAD-23	413958.29	1515697.17	11-3-23	8:59	46.93	57.75
DAD-24	400183.23	1522052.57	11-3-23	13:13	67.86	130.55
DAD-25	394560.83	1524599.12	11-3-23	15:17	67.88	77.18
DAD-26	372513.58	1530789.76	11-6-23	14:21	49.40	62.25
DAD-27			11-6-23	13:50	27.79	37.65
Notes:						
^a Horizontal control to NM State Plane Coordinates Central NAD83 Grid Coordinates (in feet)						
^b Measured in feet below the top of casing at survey point on north side of well						

Organ Dairy
 Mesquite, NM

Field Parameters and Sample Results for Monitoring wells 4th Quarter 2023

NS- Well bailed dry, insufficient amount of water to sample. NS- Well turned off / Barn being dismantled . NA- Meter Damaged.*

Well ID	Sampling Date	Depth to water (ft)	EC (μS/cm)	pH	Temp (°C)	DO (mg/L)	ORP (mv)
MW 126-04	11/20/2023	38.09	NS	NS	NS	NS	NS
MW 126-05	11/20/2023	30.70	NS	NS	NS	NS	NS
MW 126-07	11/20/2023	Dry	NS	NS	NS	NS	NS
MW 126-09	11/20/2023	Dry	NS	NS	NS	NS	NS
MW 126-12	11/20/2023	26.80	3383	7.01	19.9	NA	69
MW 126-13	11/20/2023	46.05	NA	6.79	21.5	NA	173
LRG-458S	11/8/2022	NS*	NS*	NS*	NS*	NS*	NS*

Chain-of-Custody Record

Client: EA Engineering, Science, and Technology

Mailing Address: 320 Gold Ave SW Suite
505-715-4279

Phone #: 505-715-4279

email or Fax#: rmullen@eaest.com

QA/QC Package: Standard Level 4 (Full Validation)

Accreditation: Az Compliance NELAC Other _____

EDD (Type) _____

Turn-Around Time: Standard Rush _____

Project Name: Big Sky Dairy

Project #: _____

Project Manager: Gina Mullen

Sampler: Angel N. Rivera

On Ice: Yes No

of Coolers: _____

Cooler Temp (Including CF): _____

Container Type and #	Preservative Type	HEAL No
----------------------	-------------------	---------

Date	Time	Matrix	Sample Name
11-20	11:35	Grw	833-06
11-20	13:40	Grw	833-04
11-20	16:51	Grw	833-02

2		
2		
2		

Date	Time	Matrix	Sample Name	Container Type and #	Preservative Type	HEAL No
11-20	11:35	Grw	833-06	2		
11-20	13:40	Grw	833-04	2		
11-20	16:51	Grw	833-02	2		

X		
X		
X		

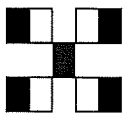

HALL ENVIRONMENTAL
ANALYSIS LABORATORY

www.hallenvironmental.com

4901 Hawkins NE - Albuquerque, NM 87109

Tel. 505-345-3975 Fax 505-345-4107

Analysis Request

Nitrate/Nitrites EPA Method 300.0	X		
TKN SM 4500 NORG C	X		
Chloride EPA 300	X		
TDS SM 2540 C MOD	X		
Sulfate EPA 300	X		
Phosphorus EPA 6010B			
Total Sulfur			

Date	Time	Relinquished by:	Received by:	Via:	Date	Time
11-20	18:35	<u>Paul Walker</u>				

Remarks: _____

If necessary, samples submitted to Hall Environmental may be subcontracted to other accredited laboratories. This serves as notice of this possibility. Any sub-contracted data will be clearly notated on the analytical report.

Chain-of-Custody Record

Client:

EA Engineering, Science, and Technology

Mailing Address:

320 Gold Ave SW Suite

Phone #: 505-715-4279

email or Fax#: rmullen@eaest.com

QA/QC Package:

Standard Level 4 (Full Validation)

Accreditation: Az Compliance

NELAC Other

EDD (Type)

Turn-Around Time:

Standard Rush

Project Name:

Big Sky Dairy

Project #:

Project Manager:

Gina Mullen

Sampler: Angel N. Rivera

On Ice: Yes No

of Coolers:

Cooler Temp (including CRT):

Container Type and #	Preservative Type	HEAL No.
2		
2		
2		

Date	Time	Matrix	Sample Name	Container Type and #	Preservative Type	HEAL No.																																		
11-21	10:37	GW	833-08	2																																				
11-21	12:35	GW	833-05	2																																				
11-21	16:10	GW	833-07	2																																				

Relinquished by:

[Signature]

Received by:

Via:

Date Time

Relinquished by:

[Signature]

Received by:

Via:

Date Time

Remarks:

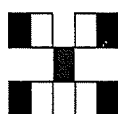

HALL ENVIRONMENTAL
ANALYSIS LABORATORY

www.hallenvironmental.com

4901 Hawkins NE - Albuquerque, NM 87109

Tel. 505-345-3975 Fax 505-345-4107

Analysis Request

If necessary, samples submitted to Hall Environmental may be subcontracted to other accredited laboratories. This serves as notice of this possibility. Any sub-contracted data will be clearly notated on the analytical report.

MONITOR WELL DEVELOPMENT FIELD FORM

FLUID LEVEL DATA

Well ID 83302 Date Gauged 11-20-23
 Site Big Sky Time Gauged 14:25

Depth to PSH _____ feet Well Diameter 4 inches
 Depth to Water 36.71 feet Height of Fluid Column 21.24 feet
 Total Depth 57.95 feet Volume in Well 14.018 gallons

(3 Well Volumes = 42.05 gallons)

GROUNDWATER SAMPLING DATA

Time/date Purged 14:33 11-20-23 Purged Method Pump

Time	Purge Vol (gal)	Cumul Purge Vol (gal)	Temp (°C)	SpC (µs/cm)	pH	ORP (mV)	DO (mg/L)
15:05	14	14	20.1	6293	7.43	257	1.58
15:28	14	28	19.6	6334	7.32		
16:11	15	43	19.7	6298	7.28		
16:10	.25	43.25	19.8	6305	7.26		

Actual Purge Volume 48 gals Field Measurements stabilized within ± 10% y

Time/Date Sampled 16:51 11-20-23 Purged/Sampled By A.W

Sample Method Pump

Requested Analyses _____

Comments/Observations _____

Well Casing Volumes

2" diameter = 0.17 gal/ft 4" diameter = 0.66 gal/ft 5" diameter = 1.02 gal/ft 6" diameter = 1.50 gal/ft

MONITOR WELL DEVELOPMENT FIELD FORM

FLUID LEVEL DATA

Well ID 833-04 Date Gauged 11-20-23
 Site Big sky Time Gauged 11:54

Depth to PSH _____ feet Well Diameter 4 inches
 Depth to Water 44.88 feet Height of Fluid Column 8.47 feet
 Total Depth 53.35 feet Volume in Well 5.590 gallons
 (3 Well Volumes = 16.77 gallons)

GROUNDWATER SAMPLING DATA

Time/date Purged 12:01 11-20-23 Purged Method Pump

Time	Purge Vol (gal)	Cumul Purge Vol (gal)	Temp (°C)	SpC (µs/cm)	pH	ORP (mV)	DO (mg/L)
12:21	5	5	21.0	4802	7.31	289	2.37
12:43	5	10	20.7	4781	7.27		
13:07	7	17	21.2	4758	7.23		

Actual Purge Volume 22 gals Field Measurements stabilized within ± 10% Y
 Time/Date Sampled 13:40 11-20-23 Purged/Sampled By A:V
 Sample Method Pump
 Requested Analyses _____
 Comments/Observations _____

Well Casing Volumes
 2" diameter = 0.17 gal/ft 4" diameter = 0.66 gal/ft 5" diameter = 1.02 gal/ft 6" diameter = 1.50 gal/ft

MONITOR WELL DEVELOPMENT FIELD FORM

FLUID LEVEL DATA

Well ID 833-05 Date Gauged 11-21-23
 Site Big Sky Time Gauged 10:53

Depth to PSH _____ feet Well Diameter 4 inches
 Depth to Water 67.52 feet Height of Fluid Column 5.98 feet
 Total Depth 73.50 feet Volume in Well 3.946 gallons
 (3 Well Volumes = 11.84 gallons)

GROUNDWATER SAMPLING DATA

Time/date Purged 11:20 11-21-23 Purged Method Pump

Time	Purge Vol (gal)	Cumul Purge Vol (gal)	Temp (°C)	SpC (µs/cm)	pH	ORP (mV)	DO (mg/L)
11:35	4	4	23.1	4658	7.08	226	2.60
11:50	4	8	23.0	4605	7.15		
12:07	4	12	23.3	4567	7.21		

Actual Purge Volume 16 gals Field Measurements stabilized within ± 10% Y
 Time/Date Sampled 12:35 11-21-23 Purged/Sampled By AN
 Sample Method Pump
 Requested Analyses _____
 Comments/Observations _____

Well Casing Volumes
 2" diameter = 0.17 gal/ft 4" diameter = 0.66 gal/ft 5" diameter = 1.02 gal/ft 6" diameter = 1.50 gal/ft

MONITOR WELL DEVELOPMENT FIELD FORM

FLUID LEVEL DATA

Well ID 833-06 Date Gauged 11-20-23
 Site Big Sky Time Gauged 9:47
 Depth to PSH _____ feet Well Diameter 4 inches
 Depth to Water 76.48 feet Height of Fluid Column 8.77 feet
 Total Depth 85.25 feet Volume in Well 5.788 gallons
 (3 Well Volumes = 17.36 gallons)

GROUNDWATER SAMPLING DATA

Time/date Purged 9:53 11-20-23 Purged Method Pump

Time	Purge Vol (gal)	Cumul Purge Vol (gal)	Temp (°C)	SpC (µs/cm)	pH	ORP (mV)	DO (mg/L)
10:15	6	6	19.7	3889	6.89	244	2.30
10:39	6	12	19.4	3976	7.05		
11:03	6	18	19.5	4015	7.23		

Actual Purge Volume 23 gals Field Measurements stabilized within ± 10% Y
 Time/Date Sampled 11:35 11-20-23 Purged/Sampled By A.N
 Sample Method Pump
 Requested Analyses _____
 Comments/Observations slow water flow

Well Casing Volumes
 2" diameter = 0.17 gal/ft 4" diameter = 0.66 gal/ft 5" diameter = 1.02 gal/ft 6" diameter = 1.50 ga/ft

MONITOR WELL DEVELOPMENT FIELD FORM

FLUID LEVEL DATA

Well ID 833-07 Date Gauged 11-21-23
 Site Big Sky Time Gauged 13:15

Depth to PSH _____ feet Well Diameter 4 inches
 Depth to Water 63.09 feet Height of Fluid Column 10.46 feet
 Total Depth 73.55 feet Volume in Well 6.903 gallons
 (3 Well Volumes = 20.71 gallons)

GROUNDWATER SAMPLING DATA

Time/date Purged 13:24 11-21-23 Purged Method Pump/Bail

Time	Purge Vol (gal)	Cumul Purge Vol (gal)	Temp (°C)	SpC (µs/cm)	pH	ORP (mV)	DO (mg/L)
13:49	7	7	22.7	5826	7.49	166	1.46
14:51	7	14	22.3	5915	7.27		
15:25	7	21	22.0	6090	7.24		
15:28	.25	21.25	22.2	6046	7.22		

Actual Purge Volume 28 gals Field Measurements stabilized within ± 10% Y
 Time/Date Sampled 16:10 11-21-23 Purged/Sampled By Ali
 Sample Method Pump/Bail
 Requested Analyses _____
 Comments/Observations @ 7 gals pump burned out, bailed out rest of gals

Well Casing Volumes
 2" diameter = 0.17 gal/ft 4" diameter = 0.66 gal/ft 5" diameter = 1.02 gal/ft 6" diameter = 1.50 gal/ft

MONITOR WELL DEVELOPMENT FIELD FORM

FLUID LEVEL DATA

Well ID 833-08 Date Gauged 11-21-23
 Site Big Sky Time Gauged 9:18

Depth to PSH _____ feet Well Diameter 4 inches
 Depth to Water 62.72 feet Height of Fluid Column 10.55 feet
 Total Depth 73.27 feet Volume in Well 6.963 gallons
 (3 Well Volumes = 20.88 gallons)

GROUNDWATER SAMPLING DATA

Time/date Purged 9:24 11-21-23 Purged Method Pump

Time	Purge Vol (gal)	Cumul Purge Vol (gal)	Temp (°C)	SpC (µs/cm)	pH	ORP (mV)	DO (mg/L)
9:38	7	7	20.2	5357	6.69	212	2.47
9:55	7	14	20.4	5335	6.99		
10:18	7	21	21.1	5311	7.15		
10:20	.25	21.25	21.3	5308	7.19		

Actual Purge Volume 26 gals Field Measurements stabilized within ± 10% Y
 Time/Date Sampled 10:37 11-21-23 Purged/Sampled By A.W
 Sample Method Pump
 Requested Analyses _____
 Comments/Observations _____

Well Casing Volumes
 2" diameter = 0.17 gal/ft 4" diameter = 0.66 gal/ft 5" diameter = 1.02 gal/ft 6" diameter = 1.50 gal/ft

MONITOR WELL DEVELOPMENT FIELD FORM

FLUID LEVEL DATA

Well ID 833-09 Date Gauged 11-27-23
 Site Big Sky Time Gauged 9:53
 Depth to PSH _____ feet Well Diameter 4 inches
 Depth to Water 29.02 feet Height of Fluid Column 10.68 feet
 Total Depth 39.70 feet Volume in Well 7.048 gallons
 (3 Well Volumes = 21.14 gallons)

GROUNDWATER SAMPLING DATA

Time/date Purged 10:00 11-27-23 Purged Method Pump

Time	Purge Vol (gal)	Cumul Purge Vol (gal)	Temp (°C)	SpC (µs/cm)	pH	ORP (mV)	DO (mg/L)
10:16	7	7	20.3	5201	6.95	122	1.40
10:34	7	14	20.4	5290	7.11		
10:53	7.25	21.25	20.2	5252	7.20		

Actual Purge Volume 26 gals Field Measurements stabilized within ± 10% Y
 Time/Date Sampled 11:15 11-27-23 Purged/Sampled By A.N
 Sample Method Pump
 Requested Analyses _____
 Comments/Observations _____

Well Casing Volumes
 2" diameter = 0.17 gal/ft 4" diameter = 0.66 gal/ft 5" diameter = 1.02 gal/ft 6" diameter = 1.50 gal/ft

MONITOR WELL DEVELOPMENT FIELD FORM

FLUID LEVEL DATA

Well ID 833-10 Date Gauged 11-27-23
 Site Big Sky Time Gauged 11:33

Depth to PSH _____ feet Well Diameter 4 inches
 Depth to Water 23.51 feet Height of Fluid Column 14.22 feet
 Total Depth 37.73 feet Volume in Well 9.385 gallons
 (3 Well Volumes = 28.15 gallons)

GROUNDWATER SAMPLING DATA

Time/date Purged 11:39 11-27-23 Purged Method Pump

Time	Purge Vol (gal)	Cumul Purge Vol (gal)	Temp (°C)	SpC (µs/cm)	pH	ORP (mV)	DO (mg/L)
12:00	10	10	19.2	4243	7.32	191	1.35
12:25	10	20	19.0	4255	7.26		
12:55	10	30	19.1	4235	7.22		

Actual Purge Volume 35 gals Field Measurements stabilized within ± 10% Y
 Time/Date Sampled 13:20 11-27-23 Purged/Sampled By A.A
 Sample Method Pump
 Requested Analyses _____
 Comments/Observations slow water flow

Well Casing Volumes
 2" diameter = 0.17 gal/ft 4" diameter = 0.66 gal/ft 5" diameter = 1.02 gal/ft 6" diameter = 1.50 gal/ft

MONITOR WELL DEVELOPMENT FIELD FORM

FLUID LEVEL DATA

Well ID 86/340-01 Date Gauged 11-8-23
 Site Bright Star Time Gauged 10:05
 Depth to PSH _____ feet Well Diameter 4 inches
 Depth to Water 60.64 feet Height of Fluid Column 10.18 feet
 Total Depth 70.82 feet Volume in Well 6.718 gallons
 (3 Well Volumes = 20.15 gallons)

GROUNDWATER SAMPLING DATA

Time/date Purged 10:15 11-8-23 Purged Method Pump

Time	Purge Vol (gal)	Cumul Purge Vol (gal)	Temp (°C)	SpC (µs/cm)	pH	ORP (mV)	DO (mg/L)
10:35	7	7	21.3	3264	7.36	174	2.42
10:55	7	14	21.1	3277	7.28		
11:17	7	21	21.0	3301	7.20		

Actual Purge Volume 26 gals Field Measurements stabilized within ± 10% Y
 Time/Date Sampled 11:30 11-8-23 Purged/Sampled By A.N
 Sample Method Pump
 Requested Analyses _____
 Comments/Observations Very slow water flow

Well Casing Volumes
 2" diameter = 0.17 gal/ft 4" diameter = 0.66 gal/ft 5" diameter = 1.02 gal/ft 6" diameter = 1.50 gal/ft

MONITOR WELL DEVELOPMENT FIELD FORM

FLUID LEVEL DATA

Well ID 70/86/340-01 Date Gauged 11-8-23
 Site Bright Star Time Gauged 11:54

Depth to PSH _____ feet Well Diameter 4 inches
 Depth to Water 54.50 feet Height of Fluid Column 13.45 feet
 Total Depth 67.95 feet Volume in Well 8.87 gallons
 (3 Well Volumes = 26.63 gallons)

GROUNDWATER SAMPLING DATA

Time/date Purged 12:06 11-8-23 Purged Method Pump

Time	Purge Vol (gal)	Cumul Purge Vol (gal)	Temp (°C)	SpC (µs/cm)	pH	ORP (mV)	DO (mg/L)
12:29	9	9	21.5	9078	7.08	207	1.55
13:03	9	18	20.8	9130	7.12		
13:35	9	27	20.9	9068	7.23		

Actual Purge Volume 31 gals Field Measurements stabilized within ± 10% Y

Time/Date Sampled 13:50 11-8-23 Purged/Sampled By A.N

Sample Method Pump

Requested Analyses _____

Comments/Observations _____

Well Casing Volumes

2" diameter = 0.17 gal/ft 4" diameter = 0.66 gal/ft 5" diameter = 1.02 gal/ft 6" diameter = 1.50 gal/ft

MONITOR WELL DEVELOPMENT FIELD FORM

FLUID LEVEL DATA

Well ID 340-01 Date Gauged 11-8-23
 Site Bright Star Time Gauged 14:35
 Depth to PSH _____ feet Well Diameter 4 inches
 Depth to Water 46.67 feet Height of Fluid Column 1.58 feet
 Total Depth 48.25 feet Volume in Well 1.042 gallons
 (3 Well Volumes = 3.12 gallons)

GROUNDWATER SAMPLING DATA

Time/date Purged 14:42 11-8-23 Purged Method Bail

Time	Purge Vol (gal)	Cumul Purge Vol (gal)	Temp (°C)	SpC (µs/cm)	pH	ORP (mV)	DO (mg/L)
14:56	1	1	21.8	4590	7.40	164	1.63
15:13	1	2	21.9	4491	7.31		
15:34	1.25	3.25	21.7	4394	7.24		

Actual Purge Volume 5.50 gals Field Measurements stabilized within ± 10% Y
 Time/Date Sampled 15:45 11-8-23 Purged/Sampled By A.N
 Sample Method Bail
 Requested Analyses _____
 Comments/Observations low water flow

Well Casing Volumes
 2" diameter = 0.17 gal/ft 4" diameter = 0.66 gal/ft 5" diameter = 1.02 gal/ft 6" diameter = 1.50 gal/ft

MONITOR WELL DEVELOPMENT FIELD FORM

FLUID LEVEL DATA

Well ID 340-02 Date Gauged 11-8-23
 Site Bright star Time Gauged 16:21

Depth to PSH _____ feet Well Diameter 4 inches
 Depth to Water Dry feet Height of Fluid Column _____ feet
 Total Depth 56.91 feet Volume in Well _____ gallons

(3 Well Volumes = _____ gallons)

GROUNDWATER SAMPLING DATA

Time/date Purged _____ Purged Method _____

Time	Purge Vol (gal)	Cumul Purge Vol (gal)	Temp (°C)	SpC (µs/cm)	pH	ORP (mV)	DO (mg/L)

Actual Purge Volume _____ gals Field Measurements stabilized within ± 10% _____
 Time/Date Sampled _____ Purged/Sampled By _____
 Sample Method _____
 Requested Analyses _____
 Comments/Observations Dry well

Well Casing Volumes
 2" diameter = 0.17 gal/ft 4" diameter = 0.66 gal/ft 5" diameter = 1.02 gal/ft 6" diameter = 1.50 gal/ft

MONITOR WELL DEVELOPMENT FIELD FORM

FLUID LEVEL DATA

Well ID 74-01 Date Gauged 11-17-28
 Site Buen Vista II Time Gauged 11:43
 Depth to PSH _____ feet Well Diameter 4 inches
 Depth to Water 38.49 feet Height of Fluid Column 6.76 feet
 Total Depth 45.25 feet Volume in Well 4.461 gallons
 (3 Well Volumes = 13.38 gallons)

GROUNDWATER SAMPLING DATA

Time/date Purged 11:50 11-17-23 Purged Method Pump

Time	Purge Vol (gal)	Cumul Purge Vol (gal)	Temp (°C)	SpC (µs/cm)	pH	ORP (mV)	DO (mg/L)
12:05	5	5	21.8	4489	7.30	201	2.53
12:20	5	10	22.4	4500	7.26		
12:41	5	15	22.6	4513	7.22		

Actual Purge Volume 20 gals Field Measurements stabilized within ± 10% Y
 Time/Date Sampled 13:05 11-17-23 Purged/Sampled By A.V.
 Sample Method Pump
 Requested Analyses _____
 Comments/Observations _____

Well Casing Volumes
 2" diameter = 0.17 gal/ft 4" diameter = 0.66 gal/ft 5" diameter = 1.02 gal/ft 6" diameter = 1.50 gal/ft

MONITOR WELL DEVELOPMENT FIELD FORM

FLUID LEVEL DATA

Well ID 74-02 Date Gauged 11-17-23
 Site Buena Vista Dairy II Time Gauged 10:20
 Depth to PSH _____ feet Well Diameter 4 inches
 Depth to Water 18.78 feet Height of Fluid Column 1.47 feet
 Total Depth 20.25 feet Volume in Well 0.970 gallons
 (3 Well Volumes = 2.91 gallons)

GROUNDWATER SAMPLING DATA

Time/date Purged 10:26 11-17-23 Purged Method Bail

Time	Purge-Vol (gal)	Cumul Purge Vol (gal)	Temp (°C)	SpC (µs/cm)	pH	ORP (mV)	DO (mg/L)
10:35	1	1	21.3	4670	7.22	183	2.63
10:47	1	2	22.1	4700	7.21		
10:58	1	3	22.2	4579	7.18		

Actual Purge Volume 5 gals Field Measurements stabilized within ± 10% Y
 Time/Date Sampled 11:22 11-17-23 Purged/Sampled By AN
 Sample Method Bail
 Requested Analyses _____
 Comments/Observations _____

Well Casing Volumes
 2" diameter = 0.17 gal/ft 4" diameter = 0.66 gal/ft 5" diameter = 1.02 gal/ft 6" diameter = 1.50 gal/ft

MONITOR WELL DEVELOPMENT FIELD FORM

FLUID LEVEL DATA

Well ID 74-03 Date Gauged 11-17-23
 Site Buena Vista II Time Gauged 8:47
 Depth to PSH _____ feet Well Diameter 4 inches
 Depth to Water 18.07 feet Height of Fluid Column 2.23 feet
 Total Depth 20.30 feet Volume in Well 1.471 gallons
 (3 Well Volumes = 4.41 gallons)

GROUNDWATER SAMPLING DATA

Time/date Purged 8:51 11-17-23 Purged Method Bail

Time	Purge Vol (gal)	Cumul Purge Vol (gal)	Temp (°C)	SpC (µs/cm)	pH	ORP (mV)	DO (mg/L)
9:03	1.50	1.50	22.6	2499	6.94	236	1.86
9:18	1.50	3	23.1	2474	7.13		
9:40	2	5	23.3	2503	7.20		

Actual Purge Volume 7 gals Field Measurements stabilized within ± 10% Y
 Time/Date Sampled 10:00 11-17-23 Purged/Sampled By A-N
 Sample Method Bail
 Requested Analyses _____
 Comments/Observations _____

Well Casing Volumes
 2" diameter = 0.17 gal/ft 4" diameter = 0.66 gal/ft 5" diameter = 1.02 gal/ft 6" diameter = 1.50 gal/ft

MONITOR WELL DEVELOPMENT FIELD FORM

FLUID LEVEL DATA

Well ID 74-04 Date Gauged 11-17-23
 Site Buena Vista II Time Gauged 13:28

Depth to PSH _____ feet Well Diameter 4 inches
 Depth to Water 50.63 feet Height of Fluid Column 7.27 feet
 Total Depth 57.90 feet Volume in Well 4.798 gallons
 (3 Well Volumes = 14.39 gallons)

GROUNDWATER SAMPLING DATA

Time/date Purged 13:34 11-17-23 Purged Method Pump

Time	Purge Vol (gal)	Cumul Purge Vol (gal)	Temp (°C)	SpC (µs/cm)	pH	ORP (mV)	DO (mg/L)
13:50	5	5	23.1	3683	7.57	237	2.78
14:10	5	10	22.6	3656	7.41		
14:30	5	15	22.7	3673	7.33		
14:33	.25	15.25	23.0	3641	7.28		

Actual Purge Volume 20 gals Field Measurements stabilized within ± 10% Y
 Time/Date Sampled 14:56 11-17-23 Purged/Sampled By A.N.
 Sample Method Pump
 Requested Analyses _____
 Comments/Observations very slow water flow.

Well Casing Volumes
 2" diameter = 0.17 gal/ft 4" diameter = 0.66 gal/ft 5" diameter = 1.02 gal/ft 6" diameter = 1.50 gal/ft

MONITOR WELL DEVELOPMENT FIELD FORM

FLUID LEVEL DATA

Well ID 74-05 Date Gauged 11-17-23
 Site Buena Vista II Time Gauged 15:24

Depth to PSH _____ feet Well Diameter 4 inches
 Depth to Water 43.36 feet Height of Fluid Column 13.83 feet
 Total Depth 57.19 feet Volume in Well 9.127 gallons
 (3 Well Volumes = 27.38 gallons)

GROUNDWATER SAMPLING DATA

Time/date Purged 15:30 11-17-23 Purged Method Pump

Time	Purge Vol (gal)	Cumul Purge Vol (gal)	Temp (°C)	SpC (µs/cm)	pH	ORP (mV)	DO (mg/L)
15:51	10	10	23.2	3580	7.60	273	2.71
16:12	10	20	23.0	3565	7.42		
16:34	8	28	23.4	3530	7.33		
16:36	.25	28.25	23.5	3526	7.30		

Actual Purge Volume 33 gals Field Measurements stabilized within ± 10% Y

Time/Date Sampled 16:45 11-17-23 Purged/Sampled By A.N

Sample Method Pump

Requested Analyses _____

Comments/Observations _____

Well Casing Volumes

2" diameter = 0.17 gal/ft 4" diameter = 0.66 gal/ft 5" diameter = 1.02 gal/ft 6" diameter = 1.50 gal/ft

Chain-of-Custody Record

Client:

EA Engineering, Science, and Technology

Mailing Address:

320 Gold Ave SW Suite

Phone #: 505-715-4279

email or Fax#: rmullen@east.com

QA/QC Package:

Standard Level 4 (Full Validation)

Accreditation: Az Compliance

NELAC Other

EDD (Type)

Turn-Around Time:

Standard Rush

Project Name:

Dona Ana Dairies (DAD'S)

Project #:

Project Manager:

Gina Mullen

Sampler: Angel Nieto Rivera

On Ice: Yes No

of Coolers:

Cooler Temp (including CF):

Container Type and #

Preservative Type

HEAL No

Date: 12-15 Time: 14:57 Matrix: Gw Sample Name: DAD-26

2

X Nitrate/Nitrites EPA Method 300

X TKN SM 4500 NORG C

X Chloride EPA 300

X TDS SM 2540 C MOD

Sulfate EPA 300

Phosphorus EPA 6010B

Total Sulfur

Remarks:

Date: 12-15 Time: 17:15 Relinquished by: [Signature]

Received by: Via: Date Time

Received by: Via: Date Time

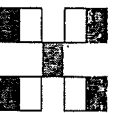

**HALL ENVIRONMENTAL
ANALYSIS LABORATORY**

www.hallenvironmental.com

4901 Hawkins NE - Albuquerque, NM 87109

Tel. 505-345-3975 Fax 505-345-4107

Analysis Request

If necessary, samples submitted to Hall Environmental may be subcontracted to other accredited laboratories. This serves as notice of this possibility. Any sub-contracted data will be clearly notated on the analytical report.

MONITOR WELL DEVELOPMENT FIELD FORM

FLUID LEVEL DATA

Well ID DAD-01 Date Gauged 12-5-23
 Site DAD's Time Gauged 8:49
 Depth to PSH _____ feet Well Diameter 2 inches
 Depth to Water 75.21 feet Height of Fluid Column 1.14 feet
 Total Depth 76.35 feet Volume in Well 0.193 gallons
 (3 Well Volumes = 0.58 gallons)

GROUNDWATER SAMPLING DATA

Time/date Purged 8:54 12-5-23 Purged Method Bail

Time	Purge-Vol (gal)	Cumul Purge Vol (gal)	Temp (°C)	SpC (µs/cm)	pH	ORP (mV)	DO (mg/L)
9:01	.25	.25	21.8	2427	7.02	205	1.81
9:05	.25	.50	21.9	2329	7.12		
9:10	.25	.75	23.2	2278	7.20		

Actual Purge Volume 1.50 gals Field Measurements stabilized within ± 10% y
 Time/Date Sampled 9:25 12-5-23 Purged/Sampled By A.N
 Sample Method Bail
 Requested Analyses _____
 Comments/Observations _____

Well Casing Volumes
 2" diameter = 0.17 gal/ft 4" diameter = 0.66 gal/ft 5" diameter = 1.02 gal/ft 6" diameter = 1.50 gal/ft

MONITOR WELL DEVELOPMENT FIELD FORM

FLUID LEVEL DATA

Well ID DAD-02 Date Gauged 12-6-23
 Site DAD's Time Gauged 14:35

Depth to PSH _____ feet Well Diameter 2 inches
 Depth to Water 68.10 feet Height of Fluid Column 0.35 feet
 Total Depth 68.45 feet Volume in Well 0.059 gallons
 (3 Well Volumes = 0.17 gallons)

GROUNDWATER SAMPLING DATA

Time/date Purged 14:40 12-6-23 Purged Method Bail

Time	Purge Vol (gal)	Cumul Purge Vol (gal)	Temp (°C)	SpC (µs/cm)	pH	ORP (mV)	DO (mg/L)
14:50	.25	.25	23.2	3379	7.43	204	2.56
15:00	.25	.50	23.4	3324	7.32		
15:10	.25	.75	23.2	3313	7.20		

Actual Purge Volume 1.50 gals Field Measurements stabilized within ± 10% Y
 Time/Date Sampled 15:36 12-6-23 Purged/Sampled By A-N
 Sample Method Bail
 Requested Analyses _____
 Comments/Observations _____

Well Casing Volumes
 2" diameter = 0.17 gal/ft 4" diameter = 0.66 gal/ft 5" diameter = 1.02 gal/ft 6" diameter = 1.50 gal/ft

MONITOR WELL DEVELOPMENT FIELD FORM

FLUID LEVEL DATA

Well ID DAD-03 Date Gauged 12-7-23
 Site DAD'S Time Gauged 9:55

Depth to PSH _____ feet Well Diameter 2 inches
 Depth to Water 15.00 feet Height of Fluid Column 3.90 feet
 Total Depth 18.90 feet Volume in Well 0.663 gallons
 (3 Well Volumes = 1.98 gallons)

GROUNDWATER SAMPLING DATA

Time/date Purged 10:05 12-7-23 Purged Method Bail

Time	Purge-Vol (gal)	Cumul Purge Vol (gal)	Temp (°C)	SpC (µs/cm)	pH	ORP (mV)	DO (mg/L)
10:20	.50	.50	20.6	2650	7.06	58	1.93
10:30	.50	1	19.9	2616	7.13		
10:47	1	2	21.3	2658	7.23		

Actual Purge Volume 4 gals Field Measurements stabilized within ± 10% Y
 Time/Date Sampled 11:10 12-7-23 Purged/Sampled By A.N
 Sample Method Bail
 Requested Analyses _____
 Comments/Observations _____

Well Casing Volumes
 2" diameter = 0.17 gal/ft 4" diameter = 0.66 gal/ft 5" diameter = 1.02 gal/ft 6" diameter = 1.50 ga/ft

MONITOR WELL DEVELOPMENT FIELD FORM

FLUID LEVEL DATA

Well ID DAD-04 Date Gauged 12-7-23
 Site DAD'S Time Gauged 11:53

Depth to PSH _____ feet Well Diameter 2 inches
 Depth to Water 18.26 feet Height of Fluid Column 0.47 feet
 Total Depth 18.73 feet Volume in Well 0.079 gallons
 (3 Well Volumes = 0.23 gallons)

GROUNDWATER SAMPLING DATA

Time/date Purged 11:58 12-7-23 Purged Method Bail

Time	Purge Vol (gal)	Cumul Purge Vol (gal)	Temp (°C)	SpC (µs/cm)	pH	ORP (mV)	DO (mg/L)
12:01	.25	.25	18.7	3252	7.38	114	2.46
12:06	.25	.50	19.9	3241	7.32		
12:12	.25	.75	20.5	3260	7.27		

Actual Purge Volume 1.50 gals Field Measurements stabilized within $\pm 10\%$ Y
 Time/Date Sampled 12:36 12-7-23 Purged/Sampled By A-N
 Sample Method Bail
 Requested Analyses _____
 Comments/Observations _____

Well Casing Volumes
 2" diameter = 0.17 gal/ft 4" diameter = 0.66 gal/ft 5" diameter = 1.02 gal/ft 6" diameter = 1.50 gal/ft

MONITOR WELL DEVELOPMENT FIELD FORM

FLUID LEVEL DATA

Well ID DAD-05 Date Gauged 12-12-23
 Site DAD'S Time Gauged 13:45

Depth to PSH _____ feet Well Diameter 2 inches
 Depth to Water 16.87 feet Height of Fluid Column 6.23 feet
 Total Depth 23.10 feet Volume in Well 1.059 gallons
 (3 Well Volumes = 3.17 gallons)

GROUNDWATER SAMPLING DATA

Time/date Purged 13:50 12-12-23 Purged Method Bail

Time	Purge-Vol (gal)	Cumul Purge Vol (gal)	Temp (°C)	SpC (µs/cm)	pH	ORP (mV)	DO (mg/L)
14:15	1	1	20.3	1519	7.33	102	1.09
14:41	1	2	20.5	1567	7.37		
14:57	1.25	3.25	20.1	1586	7.28		
15:00	.25	3.50	20.1	1592	7.26		

Actual Purge Volume 6.5 gals Field Measurements stabilized within ± 10% Y

Time/Date Sampled 15:30 12-12-23 Purged/Sampled By A.N

Sample Method Bail

Requested Analyses _____

Comments/Observations 2 @ 14:20 bailer went down well without rope. Had to fish it out.

Well Casing Volumes

2" diameter = 0.17 gal/ft 4" diameter = 0.66 gal/ft 5" diameter = 1.02 gal/ft 6" diameter = 1.50 gal/ft

MONITOR WELL DEVELOPMENT FIELD FORM

FLUID LEVEL DATA

Well ID DAD-06R Date Gauged 12-8-23
 Site DAD's Time Gauged 11:08
 Depth to PSH _____ feet Well Diameter 2 inches
 Depth to Water 86.00 feet Height of Fluid Column 16.10 feet
 Total Depth 102.10 feet Volume in Well 2.737 gallons
 (3 Well Volumes = 8.21 gallons)

GROUNDWATER SAMPLING DATA

Time/date Purged 11:13 12-8-23 Purged Method Bail

Time	Purge-Vol (gal)	Cumul Purge Vol (gal)	Temp (°C)	SpC (µs/cm)	pH	ORP (mV)	DO (mg/L)
11:35	3	3	23.7	2043	7.90	103	1.22
12:05	3	6	23.4	2056	7.69		
12:35	2.50	8.50	23.2	2083	7.52		
12:37	-25	8.75	23.3	2091	7.38		

Actual Purge Volume 11 gals Field Measurements stabilized within ± 10% Y

Time/Date Sampled 12:55 12-8-23 Purged/Sampled By A.N

Sample Method Bail

Requested Analyses _____

Comments/Observations _____

Well Casing Volumes

2" diameter = 0.17 gal/ft 4" diameter = 0.66 gal/ft 5" diameter = 1.02 gal/ft 6" diameter = 1.50 gal/ft

MONITOR WELL DEVELOPMENT FIELD FORM

FLUID LEVEL DATA

Well ID DAD-07 Date Gauged 12-13-23
 Site DAD's Time Gauged 9:25

Depth to PSH _____ feet Well Diameter 2 inches
 Depth to Water 93.45 feet Height of Fluid Column 7.20 feet
 Total Depth 100.65 feet Volume in Well 1.224 gallons
 (3 Well Volumes = 3.67 gallons)

GROUNDWATER SAMPLING DATA

Time/date Purged 9:31 12-13-23 Purged Method Bail

Time	Purge-Vol (gal)	Cumul Purge Vol (gal)	Temp (°C)	SpC (µs/cm)	pH	ORP (mV)	DO (mg/L)
9:48	1	1	22.1	4530	6.77	187	2.34
9:59	1	2	22.7	4590	7.01		
10:16	2	4	22.3	4560	7.18		

Actual Purge Volume 6 gals Field Measurements stabilized within ± 10% Y
 Time/Date Sampled 10:35 12-13-23 Purged/Sampled By AN
 Sample Method Bail
 Requested Analyses _____
 Comments/Observations _____

Well Casing Volumes
 2" diameter = 0.17 gal/ft 4" diameter = 0.66 gal/ft 5" diameter = 1.02 gal/ft 6" diameter = 1.50 gal/ft

MONITOR WELL DEVELOPMENT FIELD FORM

FLUID LEVEL DATA

Well ID DAD-08 Date Gauged 12-13-23
 Site DAD's Time Gauged 13:41

Depth to PSH _____ feet Well Diameter 2 inches
 Depth to Water 53.57 feet Height of Fluid Column 2.13 feet
 Total Depth 55.70 feet Volume in Well 0.362 gallons
 (3 Well Volumes = 1.08 gallons)

GROUNDWATER SAMPLING DATA

Time/date Purged 13:47 12-13-23 Purged Method Bail

Time	Purge Vol (gal)	Cumul Purge Vol (gal)	Temp (°C)	SpC (µs/cm)	pH	ORP (mV)	DO (mg/L)
13:52	.50	.50	20.4	6132	7.52	115	2.41
13:57	.50	1	20.5	6204	7.33		
14:02	.50	1.50	20.6	6356	7.27		

Actual Purge Volume 4 gals Field Measurements stabilized within ± 10% Y
 Time/Date Sampled 14:26 12-13-23 Purged/Sampled By A.N
 Sample Method Bail
 Requested Analyses _____
 Comments/Observations _____

Well Casing Volumes
 2" diameter = 0.17 gal/ft 4" diameter = 0.66 gal/ft 5" diameter = 1.02 gal/ft 6" diameter = 1.50 gal/ft

MONITOR WELL DEVELOPMENT FIELD FORM

FLUID LEVEL DATA

Well ID DAD-09 Date Gauged 12-14-23
 Site DAD's Time Gauged 13:15

Depth to PSH _____ feet Well Diameter 2 inches
 Depth to Water 56.97 feet Height of Fluid Column 4.28 feet
 Total Depth 61.25 feet Volume in Well 0.727 gallons
 (3 Well Volumes = 2.18 gallons)

GROUNDWATER SAMPLING DATA

Time/date Purged 13:21 12-14-23 Purged Method Bail

Time	Purge Vol (gal)	Cumul Purge Vol (gal)	Temp (°C)	SpC (µs/cm)	pH	ORP (mV)	DO (mg/L)
13:32	1	1	22.6	2312	7.34	162	1.70
13:43	1	2	22.8	2695	7.28		
13:47	.50	2.50	22.5	2817	7.23		

Actual Purge Volume 3.50 gals Field Measurements stabilized within ± 10% Y
 Time/Date Sampled 14:00 12-14-23 Purged/Sampled By A-N
 Sample Method Bail
 Requested Analyses _____
 Comments/Observations _____

Well Casing Volumes
 2" diameter = 0.17 gal/ft 4" diameter = 0.66 gal/ft 5" diameter = 1.02 gal/ft 6" diameter = 1.50 gal/ft

MONITOR WELL DEVELOPMENT FIELD FORM

FLUID LEVEL DATA

Well ID DAD-10 Date Gauged 12-14-23
 Site DAD's Time Gauged 9:05

Depth to PSH _____ feet Well Diameter 2 inches
 Depth to Water 84.66 feet Height of Fluid Column 9.15 feet
 Total Depth 93.81 feet Volume in Well 1.55 gallons
 (3 Well Volumes = 4.66 gallons)

GROUNDWATER SAMPLING DATA

Time/date Purged 9:11 12-14-23 Purged Method Bail

Time	Purge Vol (gal)	Cumul Purge Vol (gal)	Temp (°C)	SpC (µs/cm)	pH	ORP (mV)	DO (mg/L)
9:27	2	2	18.8	2185	6.88	185	1.62
9:46	2	4	19.7	2172	7.07		
9:58	1	5	19.4	2163	7.17		

Actual Purge Volume 7 gals Field Measurements stabilized within ± 10% Y
 Time/Date Sampled 10:18 12-14-23 Purged/Sampled By A.N
 Sample Method Bail
 Requested Analyses _____
 Comments/Observations _____

Well Casing Volumes
 2" diameter = 0.17 gal/ft 4" diameter = 0.66 gal/ft 5" diameter = 1.02 gal/ft 6" diameter = 1.50 gal/ft

MONITOR WELL DEVELOPMENT FIELD FORM

FLUID LEVEL DATA

Well ID DAD-11 Date Gauged 12-6-23
 Site DAD's Time Gauged 10:08

Depth to PSH _____ feet Well Diameter 4 inches
 Depth to Water 24.10 feet Height of Fluid Column 23.45 feet
 Total Depth 47.55 feet Volume in Well 15.47 gallons
 (3 Well Volumes = 46.43 gallons)

GROUNDWATER SAMPLING DATA

Time/date Purged 10:13 12-6-23 Purged Method Bail

Time	Purge-Vol (gal)	Cumul Purge Vol (gal)	Temp (°C)	SpC (µs/cm)	pH	ORP (mV)	DO (mg/L)
10:44	15	15	20.1	4849	6.92	194	2.83
11:15	15	30	20.6	5209	7.15		
11:58	17	47	20.7	5370	7.20		

Actual Purge Volume 50 gals Field Measurements stabilized within ± 10% Y
 Time/Date Sampled 12:20 12-6-23 Purged/Sampled By A.N
 Sample Method Bail
 Requested Analyses _____
 Comments/Observations _____

Well Casing Volumes
 2" diameter = 0.17 gal/ft 4" diameter = 0.66 gal/ft 5" diameter = 1.02 gal/ft 6" diameter = 1.50 gal/ft

MONITOR WELL DEVELOPMENT FIELD FORM

FLUID LEVEL DATA

Well ID DAD-12 Date Gauged 12-5-23
 Site DAD's Time Gauged 9:41

Depth to PSH _____ feet Well Diameter 2 inches
 Depth to Water 54.65 feet Height of Fluid Column 27.60 feet
 Total Depth 82.25 feet Volume in Well 4.692 gallons
 (3 Well Volumes = 14.07 gallons)

GROUNDWATER SAMPLING DATA

Time/date Purged 9:47 12-5-23 Purged Method Bail

Time	Purge-Vol (gal)	Cumul Purge Vol (gal)	Temp (°C)	SpC (µs/cm)	pH	ORP (mV)	DO (mg/L)
10:05	5	5	20.3	4607	7.16	207	1.36
10:20	5	10	20.6	4708	7.11		
10:36	5	15	20.4	4690	7.18		

Actual Purge Volume 20 gals Field Measurements stabilized within ± 10% Y
 Time/Date Sampled 10:50 12-5-23 Purged/Sampled By AN
 Sample Method Bail
 Requested Analyses _____
 Comments/Observations _____

Well Casing Volumes
 2" diameter = 0.17 gal/ft 4" diameter = 0.66 gal/ft 5" diameter = 1.02 gal/ft 6" diameter = 1.50 gal/ft

MONITOR WELL DEVELOPMENT FIELD FORM

FLUID LEVEL DATA

Well ID DAD-13 Date Gauged 12-5-23
 Site DAD's Time Gauged 13:38

Depth to PSH _____ feet Well Diameter 2 inches
 Depth to Water 88.97 feet Height of Fluid Column 3.81 feet
 Total Depth 92.78 feet Volume in Well 0.647 gallons
 (3 Well Volumes = 1.94 gallons)

GROUNDWATER SAMPLING DATA

Time/date Purged 13:45 12-5-23 Purged Method Bail

Time	Purge Vol (gal)	Cumul Purge Vol (gal)	Temp (°C)	SpC (µs/cm)	pH	ORP (mV)	DO (mg/L)
13:55	.50	.50	23.7	4164	7.31	170	2.07
14:15	1	1.50	23.1	4138	7.24		
14:20	.50	2	23.3	4175	7.20		

Actual Purge Volume 4 gals Field Measurements stabilized within ± 10% Y
 Time/Date Sampled 14:46 12-5-23 Purged/Sampled By A.N
 Sample Method Bail
 Requested Analyses _____
 Comments/Observations _____

Well Casing Volumes
 2" diameter = 0.17 gal/ft 4" diameter = 0.66 gal/ft 5" diameter = 1.02 gal/ft 6" diameter = 1.50 gal/ft

MONITOR WELL DEVELOPMENT FIELD FORM

FLUID LEVEL DATA

Well ID DAD-14 Date Gauged 12-5-23
 Site DAD's Time Gauged 11:38

Depth to PSH _____ feet Well Diameter 2 inches
 Depth to Water 32.46 feet Height of Fluid Column 10.09 feet
 Total Depth 42.55 feet Volume in Well 1.715 gallons

(3 Well Volumes = 5.14 gallons)

GROUNDWATER SAMPLING DATA

Time/date Purged 11:44 12-5-23 Purged Method Bail

Time	Purge Vol (gal)	Cumul Purge Vol (gal)	Temp (°C)	SpC (µs/cm)	pH	ORP (mV)	DO (mg/L)
12:03	2	2	22.0	6159	7.57	199	2.42
12:19	2	4	21.9	6360	7.48		
12:28	1.50	5.50	22.2	6533	7.33		
12:32	.25	5.75	22.4	6476	7.30		

Actual Purge Volume 8 gals Field Measurements stabilized within ± 10% Y
 Time/Date Sampled 12:54 12-5-23 Purged/Sampled By A.N
 Sample Method Bail
 Requested Analyses _____
 Comments/Observations _____

Well Casing Volumes
 2" diameter = 0.17 gal/ft 4" diameter = 0.66 gal/ft 5" diameter = 1.02 gal/ft 6" diameter = 1.50 gal/ft

MONITOR WELL DEVELOPMENT FIELD FORM

FLUID LEVEL DATA

Well ID DAD-15 Date Gauged 12-8-23
 Site DAD's Time Gauged 9:28

Depth to PSH _____ feet Well Diameter 2 inches
 Depth to Water 97.02 feet Height of Fluid Column 12.88 feet
 Total Depth 109.90 feet Volume in Well 2.189 gallons
 (3 Well Volumes = 6.56 gallons)

GROUNDWATER SAMPLING DATA

Time/date Purged 9:34 12-8-23 Purged Method Bail

Time	Purge Vol (gal)	Cumul Purge Vol (gal)	Temp (°C)	SpC (µs/cm)	pH	ORP (mV)	DO (mg/L)
9:48	2	2	22.2	3535	7.41	173	2.71
10:05	2	4	22.6	3781	7.32		
10:25	3	7	23.4	3821	7.26		

Actual Purge Volume 9 gals Field Measurements stabilized within ± 10% Y
 Time/Date Sampled 10:40 12-8-23 Purged/Sampled By A.N
 Sample Method Bail
 Requested Analyses _____
 Comments/Observations _____

Well Casing Volumes
 2" diameter = 0.17 gal/ft 4" diameter = 0.66 gal/ft 5" diameter = 1.02 gal/ft 6" diameter = 1.50 gal/ft

MONITOR WELL DEVELOPMENT FIELD FORM

FLUID LEVEL DATA

Well ID DAD-16 Date Gauged 12-7-23
 Site DAD'S Time Gauged 13:20

Depth to PSH _____ feet Well Diameter 2 inches
 Depth to Water 20.28 feet Height of Fluid Column 12.47 feet
 Total Depth 32.75 feet Volume in Well 2.119 gallons
 (3 Well Volumes = 6.35 gallons)

GROUNDWATER SAMPLING DATA

Time/date Purged 13:25 12-7-23 Purged Method Bail

Time	Purge Vol (gal)	Cumul Purge Vol (gal)	Temp (°C)	SpC (µs/cm)	pH	ORP (mV)	DO (mg/L)
13:45	2	2	18.8	2558	7.81	114	1.92
14:00	2	4	19.1	2512	7.57		
14:21	3	7	19.4	2503	7.42		
14:24	.25	7.25	19.6	2488	7.34		

Actual Purge Volume 9 gals Field Measurements stabilized within ± 10% Y
 Time/Date Sampled 14:47 12-7-23 Purged/Sampled By A.N
 Sample Method Bail
 Requested Analyses _____
 Comments/Observations _____

Well Casing Volumes

2" diameter = 0.17 gal/ft 4" diameter = 0.66 gal/ft 5" diameter = 1.02 gal/ft 6" diameter = 1.50 gal/ft

MONITOR WELL DEVELOPMENT FIELD FORM

FLUID LEVEL DATA

Well ID DAD-17 Date Gauged 12-12-23
 Site DAD's Time Gauged 11:05
 Depth to PSH _____ feet Well Diameter 2 inches
 Depth to Water 21.44 feet Height of Fluid Column 17.46 feet
 Total Depth 38.90 feet Volume in Well 2.968 gallons
 (3 Well Volumes = 8.90 gallons)

GROUNDWATER SAMPLING DATA

Time/date Purged 11:10 12-12-23 Purged Method Bail

Time	Purge Vol (gal)	Cumul Purge Vol (gal)	Temp (°C)	SpC (µs/cm)	pH	ORP (mV)	DO (mg/L)
11:20	3	3	21.4	1123	7.46	169	1.20
11:28	3	6	21.8	1132	7.34		
11:37	3	9	21.7	1162	7.25		

Actual Purge Volume 12 gals Field Measurements stabilized within ± 10% Y
 Time/Date Sampled 11:52 12-12-23 Purged/Sampled By A.N
 Sample Method Bail
 Requested Analyses _____
 Comments/Observations _____

Well Casing Volumes
 2" diameter = 0.17 gal/ft 4" diameter = 0.66 gal/ft 5" diameter = 1.02 gal/ft 6" diameter = 1.50 gal/ft

MONITOR WELL DEVELOPMENT FIELD FORM

FLUID LEVEL DATA

Well ID DAD-18 Date Gauged 12-13-23
 Site DAD's Time Gauged 10:57

Depth to PSH _____ feet Well Diameter 2 inches
 Depth to Water 24.69 feet Height of Fluid Column 32.46 feet
 Total Depth 57.15 feet Volume in Well 5.518 gallons
 (3 Well Volumes = 16.55 gallons)

GROUNDWATER SAMPLING DATA

Time/date Purged 11:04 12-13-23 Purged Method Bail

Time	Purge Vol (gal)	Cumul Purge Vol (gal)	Temp (°C)	SpC (µs/cm)	pH	ORP (mV)	DO (mg/L)
11:20	5	5	16.9	4105	7.30	113	2.23
11:37	5	10	17.2	4077	7.24		
11:58	7	17	17.8	4051	7.19		

Actual Purge Volume 21 gals Field Measurements stabilized within ± 10% Y
 Time/Date Sampled 12:20 12-13-23 Purged/Sampled By A.W
 Sample Method Bail
 Requested Analyses _____
 Comments/Observations _____

Well Casing Volumes
 2" diameter = 0.17 gal/ft 4" diameter = 0.66 gal/ft 5" diameter = 1.02 gal/ft 6" diameter = 1.50 gal/ft

MONITOR WELL DEVELOPMENT FIELD FORM

FLUID LEVEL DATA

Well ID DAD-19 Date Gauged 12-12-23
 Site DAD's Time Gauged 9:15
 Depth to PSH _____ feet Well Diameter 2 inches
 Depth to Water 66.10 feet Height of Fluid Column 33.25 feet
 Total Depth 99.35 feet Volume in Well 5.652 gallons
 (3 Well Volumes = 16.95 gallons)

GROUNDWATER SAMPLING DATA

Time/date Purged 9:21 12-12-23 Purged Method Bail

Time	Purge Vol (gal)	Cumul Purge Vol (gal)	Temp (°C)	SpC (µs/cm)	pH	ORP (mV)	DO (mg/L)
9:35	5	5	20.3	4695	6.70	195	1.61
9:51	5	10	20.8	4683	7.05		
10:15	7	17	20.4	4719	7.17		

Actual Purge Volume 21 gals Field Measurements stabilized within ± 10% Y
 Time/Date Sampled 10:40 12-12-23 Purged/Sampled By A.W
 Sample Method Bail
 Requested Analyses _____
 Comments/Observations _____

Well Casing Volumes
 2" diameter = 0.17 gal/ft 4" diameter = 0.66 gal/ft 5" diameter = 1.02 gal/ft 6" diameter = 1.50 gal/ft

MONITOR WELL DEVELOPMENT FIELD FORM

FLUID LEVEL DATA

Well ID DAD-20 Date Gauged 12-15-23
 Site DAD's Time Gauged 15:30

Depth to PSH _____ feet Well Diameter 2 inches
 Depth to Water 58.38 feet Height of Fluid Column 10.47 feet
 Total Depth 68.85 feet Volume in Well 1.779 gallons
 (3 Well Volumes = 5.33 gallons)

GROUNDWATER SAMPLING DATA

Time/date Purged 15:38 12-15-23 Purged Method Bail

Time	Purge Vol (gal)	Cumul Purge Vol (gal)	Temp (°C)	SpC (µs/cm)	pH	ORP (mV)	DO (mg/L)

Actual Purge Volume gals Field Measurements stabilized within ± 10%
 Time/Date Sampled Purged/Sampled By
 Sample Method
 Requested Analyses

Comments/Observations Well looks damaged, they moved it with heavy equipment. Bailer will no go in well. Tried moving well with tools. still could not get bailer to go inside.

Well Casing Volumes
 2" diameter = 0.17 gal/ft 4" diameter = 0.66 gal/ft 5" diameter = 1.02 gal/ft 6" diameter = 1.50 gal/ft

MONITOR WELL DEVELOPMENT FIELD FORM

FLUID LEVEL DATA

Well ID DAD-21 Date Gauged 12-14-23
 Site DAD'S Time Gauged 10:35

Depth to PSH _____ feet Well Diameter 2 inches
 Depth to Water 58.87 feet Height of Fluid Column 7.66 feet
 Total Depth 66.53 feet Volume in Well 1.302 gallons
 (3 Well Volumes = 3.90 gallons)

GROUNDWATER SAMPLING DATA

Time/date Purged 10:47 12-14-23 Purged Method Bail

Time	Purge-Vol (gal)	Cumul Purge Vol (gal)	Temp (°C)	SpC (µs/cm)	pH	ORP (mV)	DO (mg/L)
10:59	1.50	1.50	21.0	3741	7.08	192	2.88
11:12	1.50	3	21.6	3940	7.14		
11:29	1	4	21.8	3983	7.22		

Actual Purge Volume 6 gals Field Measurements stabilized within ± 10% Y
 Time/Date Sampled 12:31 12-14-23 Purged/Sampled By A.N
 Sample Method Bail
 Requested Analyses _____
 Comments/Observations water started to drop down @ 3 gals.

Well Casing Volumes
 2" diameter = 0.17 gal/ft 4" diameter = 0.66 gal/ft 5" diameter = 1.02 gal/ft 6" diameter = 1.50 gal/ft

MONITOR WELL DEVELOPMENT FIELD FORM

FLUID LEVEL DATA

Well ID DAD-22 Date Gauged 12-14-23
 Site DAD'S Time Gauged 14:11

Depth to PSH _____ feet Well Diameter 2 inches
 Depth to Water 46.92 feet Height of Fluid Column 3.13 feet
 Total Depth 50.05 feet Volume in Well 0.532 gallons
 (3 Well Volumes = 1.59 gallons)

GROUNDWATER SAMPLING DATA

Time/date Purged 14:16 12-14-23 Purged Method Bail

Time	Purge Vol (gal)	Cumul Purge Vol (gal)	Temp (°C)	SpC (µs/cm)	pH	ORP (mV)	DO (mg/L)
14:21	.50	.50	22.2	3655	7.51	152	2.79
14:26	.50	1	22.6	3676	7.37		
14:34	.75	1.75	22.4	3682	7.30		
14:35	.25	2	22.4	3694	7.28		

Actual Purge Volume 3.25 gals Field Measurements stabilized within ± 10% Y
 Time/Date Sampled 14:46 12-14-23 Purged/Sampled By AN
 Sample Method Bail
 Requested Analyses _____
 Comments/Observations _____

Well Casing Volumes
 2" diameter = 0.17 gal/ft 4" diameter = 0.66 gal/ft 5" diameter = 1.02 gal/ft 6" diameter = 1.50 gal/ft

MONITOR WELL DEVELOPMENT FIELD FORM

FLUID LEVEL DATA

Well ID DAD-23 Date Gauged 12-6-23
 Site DAD's Time Gauged 12:55

Depth to PSH _____ feet Well Diameter 2 inches
 Depth to Water 46.95 feet Height of Fluid Column 10.80 feet
 Total Depth 57.75 feet Volume in Well 1.836 gallons

(3 Well Volumes = 5.50 gallons)

GROUNDWATER SAMPLING DATA

Time/date Purged 13:01 12-6-23 Purged Method Bail

Time	Purge Vol (gal)	Cumul Purge Vol (gal)	Temp (°C)	SpC (µs/cm)	pH	ORP (mV)	DO (mg/L)
13:17	2	2	22.5	3036	7.60	156	2.27
13:26	2	4	22.8	2801	7.42		
13:41	2	6	22.7	2486	7.29		

Actual Purge Volume 8 gals Field Measurements stabilized within ± 10% Y
 Time/Date Sampled 14:00 12-6-23 Purged/Sampled By A.N
 Sample Method Bail
 Requested Analyses _____
 Comments/Observations _____

Well Casing Volumes

2" diameter = 0.17 gal/ft 4" diameter = 0.66 gal/ft 5" diameter = 1.02 gal/ft 6" diameter = 1.50 gal/ft

MONITOR WELL DEVELOPMENT FIELD FORM

FLUID LEVEL DATA

Well ID DAD-24 Date Gauged 12-8-23
 Site DAD's Time Gauged 13:41

Depth to PSH _____ feet Well Diameter 2 inches
 Depth to Water 67.83 feet Height of Fluid Column 62.72 feet
 Total Depth 130.55 feet Volume in Well 10.662 gallons
 (3 Well Volumes = 31.98 gallons)

GROUNDWATER SAMPLING DATA

Time/date Purged 13:46 12-8-23 Purged Method Bail

Time	Purge Vol (gal)	Cumul Purge Vol (gal)	Temp (°C)	SpC (µs/cm)	pH	ORP (mV)	DO (mg/L)
<u>14:22</u>	<u>10</u>	<u>10</u>	<u>22.0</u>	<u>4309</u>	<u>7.35</u>	<u>126</u>	<u>1.33</u>
<u>14:55</u>	<u>10</u>	<u>20</u>	<u>22.2</u>	<u>4363</u>	<u>7.30</u>		
<u>15:38</u>	<u>12</u>	<u>32</u>	<u>22.3</u>	<u>4402</u>	<u>7.25</u>		

Actual Purge Volume 36 gals Field Measurements stabilized within ± 10% Y
 Time/Date Sampled 16:18 12-8-23 Purged/Sampled By A.N
 Sample Method Bail
 Requested Analyses _____
 Comments/Observations _____

Well Casing Volumes
 2" diameter = 0.17 gal/ft 4" diameter = 0.66 gal/ft 5" diameter = 1.02 gal/ft 6" diameter = 1.50 gal/ft

MONITOR WELL DEVELOPMENT FIELD FORM

FLUID LEVEL DATA

Well ID DAD-25 Date Gauged 12-13-23
 Site DAD's Time Gauged 14:43

Depth to PSH _____ feet Well Diameter 2 inches
 Depth to Water 67.84 feet Height of Fluid Column 9.34 feet
 Total Depth 77.18 feet Volume in Well 1.587 gallons
 (3 Well Volumes = 4.76 gallons)

GROUNDWATER SAMPLING DATA

Time/date Purged 14:48 12-13-23 Purged Method Bail

Time	Purge Vol (gal)	Cumul Purge Vol (gal)	Temp (°C)	SpC (µs/cm)	pH	ORP (mV)	DO (mg/L)
15:05	1.50	1.50	21.0	3490	7.76	169	2.63
15:24	1.50	3	21.6	3369	7.62		
15:40	2	5	21.2	3352	7.42		
15:43	.25	5.25	21.5	3347	7.30		

Actual Purge Volume 7 gals Field Measurements stabilized within ± 10% Y
 Time/Date Sampled 16:18 12-13-23 Purged/Sampled By A.n
 Sample Method Bail
 Requested Analyses _____
 Comments/Observations _____

Well Casing Volumes

2" diameter = 0.17 gal/ft 4" diameter = 0.66 gal/ft 5" diameter = 1.02 gal/ft 6" diameter = 1.50 ga/ft

MONITOR WELL DEVELOPMENT FIELD FORM

FLUID LEVEL DATA

Well ID DAD-26 Date Gauged 12-15-23
 Site DAD's Time Gauged 13:50

Depth to PSH _____ feet Well Diameter 2 inches
 Depth to Water 49.30 feet Height of Fluid Column 12.87 feet
 Total Depth 62.25 feet Volume in Well 2.187 gallons
 (3 Well Volumes = 6.56 gallons)

GROUNDWATER SAMPLING DATA

Time/date Purged 13:55 12-15-23 Purged Method Bail

Time	Purge-Vol (gal)	Cumul Purge Vol (gal)	Temp (°C)	SpC (µs/cm)	pH	ORP (mV)	DO (mg/L)
14:15	2	2	21.8	4412	6.93	201	1.41
14:28	2	4	22.3	4381	7.08		
14:46	3	7	21.9	4395	7.20		

Actual Purge Volume 9 gals Field Measurements stabilized within ± 10% Y
 Time/Date Sampled 14:57 12-15-23 Purged/Sampled By A.W
 Sample Method Bail
 Requested Analyses _____
 Comments/Observations _____

Well Casing Volumes
 2" diameter = 0.17 gal/ft 4" diameter = 0.66 gal/ft 5" diameter = 1.02 gal/ft 6" diameter = 1.50 gal/ft

MONITOR WELL DEVELOPMENT FIELD FORM

FLUID LEVEL DATA

Well ID DAD-27 Date Gauged 12-14-23
 Site DAD's Time Gauged 15:00

Depth to PSH _____ feet Well Diameter 2 inches
 Depth to Water 27.76 feet Height of Fluid Column 9.89 feet
 Total Depth 37.65 feet Volume in Well 1.681 gallons

(3 Well Volumes = 5.04 gallons)

GROUNDWATER SAMPLING DATA

Time/date Purged 15:05 12-14-23 Purged Method Bail

Time	Purge-Vol (gal)	Cumul Purge Vol (gal)	Temp (°C)	SpC (µs/cm)	pH	ORP (mV)	DO (mg/L)
15:17	2	2	21.8	3000	7.53	163	2.26
15:30	2	4	21.9	2991	7.38		
15:40	1.25	5.25	21.7	2932	7.24		

Actual Purge Volume 7.50 gals Field Measurements stabilized within ± 10% Y

Time/Date Sampled 15:55 12-14-23 Purged/Sampled By A.N

Sample Method Bail

Requested Analyses _____

Comments/Observations _____

Well Casing Volumes

2" diameter = 0.17 gal/ft 4" diameter = 0.66 gal/ft 5" diameter = 1.02 gal/ft 6" diameter = 1.50 gal/ft

MONITOR WELL DEVELOPMENT FIELD FORM

FLUID LEVEL DATA

Well ID Ew-01 Date Gauged 12-4-23
 Site Del Oro Time Gauged 14:30
 Depth to PSH _____ feet Well Diameter 4 inches
 Depth to Water - feet Height of Fluid Column _____ feet
 Total Depth - feet Volume in Well _____ gallons
 (3 Well Volumes = 15 gallons)

GROUNDWATER SAMPLING DATA

Time/date Purged 14:33 12-4-23 Purged Method Pump

Time	Purge Vol (gal)	Cumul Purge Vol (gal)	Temp (°C)	SpC (µs/cm)	pH	ORP (mV)	DO (mg/L)
14:48	5	5	22.2	6109	7.28	213	2.48
15:01	5	10	22.3	6126	7.24		
15:18	5	15	22.6	6149	7.21		

Actual Purge Volume 20 gals Field Measurements stabilized within ± 10% Y
 Time/Date Sampled 15:40 12-4-23 Purged/Sampled By A.N
 Sample Method Pump
 Requested Analyses _____
 Comments/Observations _____

Well Casing Volumes
 2" diameter = 0.17 gal/ft 4" diameter = 0.66 gal/ft 5" diameter = 1.02 gal/ft 6" diameter = 1.50 gal/ft

MONITOR WELL DEVELOPMENT FIELD FORM

FLUID LEVEL DATA

Well ID EW-02 Date Gauged 11-29-23
 Site Dcl Oro Time Gauged 14:52

Depth to PSH _____ feet Well Diameter 4 inches
 Depth to Water - feet Height of Fluid Column _____ feet
 Total Depth _____ feet Volume in Well _____ gallons

(3 Well Volumes = 15 gallons)

GROUNDWATER SAMPLING DATA

Time/date Purged 14:55 11-29-23 Purged Method Pump

Time	Purge Vol (gal)	Cumul Purge Vol (gal)	Temp (°C)	SpC (µs/cm)	pH	ORP (mV)	DO (mg/L)
15:10	5	5	22.4	4985	7.27	242	2.35
15:31	5	10	22.6	4970	7.24		
15:50	5	15	22.8	4953	7.21		

Actual Purge Volume 20 gals Field Measurements stabilized within ± 10% Y
 Time/Date Sampled 16:20 11-29-23 Purged/Sampled By A.N
 Sample Method Pump
 Requested Analyses _____
 Comments/Observations _____

Well Casing Volumes
 2" diameter = 0.17 gal/ft 4" diameter = 0.66 gal/ft 5" diameter = 1.02 gal/ft 6" diameter = 1.50 gal/ft

MONITOR WELL DEVELOPMENT FIELD FORM

FLUID LEVEL DATA

Well ID Ew-04 Date Gauged 11-29-23
 Site Del Oro Time Gauged 13:30

Depth to PSH _____ feet Well Diameter 4 inches
 Depth to Water _____ feet Height of Fluid Column _____ feet
 Total Depth _____ feet Volume in Well _____ gallons

(3 Well Volumes = 15 gallons)

GROUNDWATER SAMPLING DATA

Time/date Purged 13:31 11-29-23 Purged Method Pump

Time	Purge Vol (gal)	Cumul Purge Vol (gal)	Temp (°C)	SpC (µs/cm)	pH	ORP (mV)	DO (mg/L)
13:43	5	5	27.4	2411	7.50	212	1.78
13:56	5	10	25.0	2364	7.31		
14:08	5	15	24.4	2380	7.24		

Actual Purge Volume 20 gals Field Measurements stabilized within ± 10% Y

Time/Date Sampled 14:24 11-29-23 Purged/Sampled By A.N

Sample Method Pump

Requested Analyses _____

Comments/Observations _____

Well Casing Volumes

2" diameter = 0.17 gal/ft 4" diameter = 0.66 gal/ft 5" diameter = 1.02 gal/ft 6" diameter = 1.50 gal/ft

MONITOR WELL DEVELOPMENT FIELD FORM

FLUID LEVEL DATA

Well ID EW-05 Date Gauged 11-29-23
 Site Del Oro Time Gauged 10:05

Depth to PSH _____ feet Well Diameter 4 inches
 Depth to Water — feet Height of Fluid Column _____ feet
 Total Depth — feet Volume in Well _____ gallons

(3 Well Volumes = 15 gallons)

GROUNDWATER SAMPLING DATA

Time/date Purged 10:18 11-29-23 Purged Method Pump

Time	Purge Vol (gal)	Cumul Purge Vol (gal)	Temp (°C)	SpC (µs/cm)	pH	ORP (mV)	DO (mg/L)
10:31	5	5	26.2	2871	7.33	160	2.16
10:43	5	10	23.9	2854	7.28		
10:55	5	15	22.8	2843	7.23		

Actual Purge Volume 20 gals Field Measurements stabilized within ± 10% Y
 Time/Date Sampled 11:15 11-29-23 Purged/Sampled By A.N
 Sample Method Pump
 Requested Analyses _____
 Comments/Observations _____

Well Casing Volumes
 2" diameter = 0.17 gal/ft 4" diameter = 0.66 gal/ft 5" diameter = 1.02 gal/ft 6" diameter = 1.50 gal/ft

MONITOR WELL DEVELOPMENT FIELD FORM

FLUID LEVEL DATA

Well ID 692-02 Date Gauged 11-29-23
 Site Del Oro Time Gauged 11:42

Depth to PSH _____ feet Well Diameter 4 inches
 Depth to Water 59.62 feet Height of Fluid Column 6.53 feet
 Total Depth 66.15 feet Volume In Well 4.309 gallons
 (3 Well Volumes = 12.92 gallons)

GROUNDWATER SAMPLING DATA

Time/date Purged 11:52 11-29-23 Purged Method Pump

Time	Purge Vol (gal)	Cumul Purge Vol (gal)	Temp (°C)	SpC (µs/cm)	pH	ORP (mV)	DO (mg/L)
12:17	5	5	22.1	2764	7.57	207	2.02
12:35	5	10	22.2	2725	7.33		
12:52	3	13	22.4	2703	7.25		

Actual Purge Volume 17 gals Field Measurements stabilized within ± 10% Y

Time/Date Sampled 13:18 11-29-23 Purged/Sampled By A.N

Sample Method Pump

Requested Analyses _____

Comments/Observations slow water flow coming from pump. Pump would stop thru pump.

Well Casing Volumes
 2" diameter = 0.17 gal/ft 4" diameter = 0.66 gal/ft 5" diameter = 1.02 gal/ft 6" diameter = 1.50 gal/ft

MONITOR WELL DEVELOPMENT FIELD FORM

FLUID LEVEL DATA

Well ID 692-05 Date Gauged 12-1-23
 Site Del Oro Time Gauged 9:28
 Depth to PSH _____ feet Well Diameter 4 inches
 Depth to Water 82.71 feet Height of Fluid Column 4.79 feet
 Total Depth 87.50 feet Volume in Well 3.161 gallons
 (3 Well Volumes = 9.48 gallons)

GROUNDWATER SAMPLING DATA

Time/date Purged 9:45 12-1-23 Purged Method Bail

Time	Purge Vol (gal)	Cumul Purge Vol (gal)	Temp (°C)	SpC (µs/cm)	pH	ORP (mV)	DO (mg/L)
10:05	3	3	20.6	2574	7.07	192	1.94
10:23	3	6	20.8	2527	7.13		
10:48	4	10	20.9	2546	7.20		

Actual Purge Volume 12 gals Field Measurements stabilized within ± 10% Y

Time/Date Sampled 11:05 12-1-23 Purged/Sampled By A. n

Sample Method Bail

Requested Analyses _____

Comments/Observations _____

Well Casing Volumes
 2" diameter = 0.17 gal/ft 4" diameter = 0.66 gal/ft 5" diameter = 1.02 gal/ft 6" diameter = 1.50 gal/ft

MONITOR WELL DEVELOPMENT FIELD FORM

FLUID LEVEL DATA

Well ID 692-06 Date Gauged 12-1-23
 Site Del Oro Time Gauged 11:25
 Depth to PSH _____ feet Well Diameter 4 inches
 Depth to Water 84.90 feet Height of Fluid Column 5.35 feet
 Total Depth 90.25 feet Volume in Well 3.531 gallons
 (3 Well Volumes = 10.59 gallons)

GROUNDWATER SAMPLING DATA

Time/date Purged 11:31 12-1-23 Purged Method Bail

Time	Purge Vol (gal)	Cumul Purge Vol (gal)	Temp (°C)	SpC (µs/cm)	pH	ORP (mV)	DO (mg/L)
11:51	4	4	20.0	2371	7.39	182	1.76
12:15	4	8	20.7	2333	7.45		
12:35	3	11	20.1	2296	7.30		
12:37	.25	11.25	20.3	2303	7.28		

Actual Purge Volume 13 gals Field Measurements stabilized within ± 10% Y
 Time/Date Sampled 12:50 12-1-23 Purged/Sampled By AN
 Sample Method Bail
 Requested Analyses _____
 Comments/Observations _____

Well Casing Volumes
 2" diameter = 0.17 gal/ft 4" diameter = 0.66 gal/ft 5" diameter = 1.02 gal/ft 6" diameter = 1.50 gal/ft

MONITOR WELL DEVELOPMENT FIELD FORM

FLUID LEVEL DATA

Well ID 692-07 Date Gauged 12-1-23
 Site Del Oro Time Gauged 13:35

Depth to PSH _____ feet Well Diameter 4 inches
 Depth to Water 76.63 feet Height of Fluid Column 1.07 feet
 Total Depth 77.70 feet Volume in Well 0.706 gallons
 (3 Well Volumes = 2.11 gallons)

GROUNDWATER SAMPLING DATA

Time/date Purged 13:41 12-1-23 Purged Method Bail

Time	Purge Vol (gal)	Cumul Purge Vol (gal)	Temp (°C)	SpC (µs/cm)	pH	ORP (mV)	DO (mg/L)
13:52	.50	.50	20.2	2429	7.68	153	1.86
13:58	.50	1	20.3	2453	7.46		
14:18	1.25	2.25	21.1	2507	7.33		

Actual Purge Volume 4.50 gals Field Measurements stabilized within ± 10% Y
 Time/Date Sampled 14:20 12-1-23 Purged/Sampled By A.N
 Sample Method Bail
 Requested Analyses _____
 Comments/Observations slow water recovery after 3 gals

Well Casing Volumes

2" diameter = 0.17 gal/ft 4" diameter = 0.66 gal/ft 5" diameter = 1.02 gal/ft 6" diameter = 1.50 gal/ft

MONITOR WELL DEVELOPMENT FIELD FORM

FLUID LEVEL DATA

Well ID 692-08 Date Gauged 12-4-23
 Site Del Oro Time Gauged 11:46
 Depth to PSH _____ feet Well Diameter 4 inches
 Depth to Water 70.86 feet Height of Fluid Column 6.29 feet
 Total Depth 77.15 feet Volume in Well 4.151 gallons
 (3 Well Volumes = 12.45 gallons)

GROUNDWATER SAMPLING DATA

Time/date Purged 11:53 12-4-23 Purged Method Pump

Time	Purge Vol (gal)	Cumul Purge Vol (gal)	Temp (°C)	SpC (µs/cm)	pH	ORP (mV)	DO (mg/L)
12:38	4	4	23.8	2195	7.29	68	1.56
13:15	4	8	26.6	2231	7.35		
13:49	5	13	27.5	2251	7.26		

Actual Purge Volume 17 gals Field Measurements stabilized within ± 10% Y
 Time/Date Sampled 14:17 12-4-23 Purged/Sampled By A.N
 Sample Method Pump
 Requested Analyses _____
 Comments/Observations _____

Well Casing Volumes
 2" diameter = 0.17 gal/ft 4" diameter = 0.66 gal/ft 5" diameter = 1.02 gal/ft 6" diameter = 1.50 gal/ft

MONITOR WELL DEVELOPMENT FIELD FORM

FLUID LEVEL DATA

Well ID 69209 Date Gauged 12-4-23
 Site Del Oro Time Gauged 9:28
 Depth to PSH _____ feet Well Diameter 4 inches
 Depth to Water 86.05 feet Height of Fluid Column 5.05 feet
 Total Depth 91.10 feet Volume in Well 3.333 gallons
 (3 Well Volumes = 9.99 gallons)

GROUNDWATER SAMPLING DATA

Time/date Purged 9:34 12-4-23 Purged Method Pump

Time	Purge Vol (gal)	Cumul Purge Vol (gal)	Temp (°C)	SpC (µs/cm)	pH	ORP (mV)	DO (mg/L)
9:49	3	3	19.9	2200	6.83	189	1.62
10:10	3	6	21.6	2254	6.96		
10:36	4	10	23.1	2283	7.19		

Actual Purge Volume 13 gals Field Measurements stabilized within ± 10% Y
 Time/Date Sampled 11:09 12-4-23 Purged/Sampled By A.N
 Sample Method Pump
 Requested Analyses _____
 Comments/Observations _____

Well Casing Volumes
 2" diameter = 0.17 gal/ft 4" diameter = 0.66 gal/ft 5" diameter = 1.02 gal/ft 6" diameter = 1.50 gal/ft

MONITOR WELL DEVELOPMENT FIELD FORM

FLUID LEVEL DATA

Well ID 692-10 Date Gauged 12-1-23
 Site Del Oro Time Gauged 14:38

Depth to PSH _____ feet Well Diameter 2 inches
 Depth to Water 75.91 feet Height of Fluid Column 1.99 feet
 Total Depth 77.90 feet Volume in Well 0.338 gallons
 (3 Well Volumes = 1.01 gallons)

GROUNDWATER SAMPLING DATA

Time/date Purged 14:44 12-1-23 Purged Method Bail

Time	Purge Vol (gal)	Cumul Purge Vol (gal)	Temp (°C)	SpC (µs/cm)	pH	ORP (mV)	DO (mg/L)
14:55	.50	.50	21.4	2770	7.61	224	2.08
15:08	.50	1	21.9	2748	7.52		
15:12	.25	1.25	22.1	2756	7.37		

Actual Purge Volume 3 gals Field Measurements stabilized within ± 10% Y
 Time/Date Sampled 15:30 12-1-23 Purged/Sampled By A.N
 Sample Method Bail
 Requested Analyses _____
 Comments/Observations _____

Well Casing Volumes
 2" diameter = 0.17 gal/ft 4" diameter = 0.66 gal/ft 5" diameter = 1.02 gal/ft 6" diameter = 1.50 gal/ft

MONITOR WELL DEVELOPMENT FIELD FORM

FLUID LEVEL DATA

Well ID 624-01 Date Gauged 11-10-23
 Site Dominquez 1 Time Gauged 12:15

Depth to PSH _____ feet Well Diameter 4 inches
 Depth to Water 30.36 feet Height of Fluid Column 16.44 feet
 Total Depth 46.80 feet Volume in Well 10.850 gallons
 (3 Well Volumes = 32.55 gallons)

GROUNDWATER SAMPLING DATA

Time/date Purged 12:25 11-10-23 Purged Method Pump

Time	Purge Vol (gal)	Cumul Purge Vol (gal)	Temp (°C)	SpC (µs/cm)	pH	ORP (mV)	DO (mg/L)
12:55	10	10	19.3	4381	7.61	183	1.14
13:25	10	20	19.4	4341	7.40		
14:05	13	33	19.2	4362	7.31		

Actual Purge Volume 38 gals Field Measurements stabilized within ± 10% Y
 Time/Date Sampled 14:25 11-10-23 Purged/Sampled By A.N
 Sample Method Pump
 Requested Analyses _____
 Comments/Observations _____

Well Casing Volumes
 2" diameter = 0.17 gal/ft 4" diameter = 0.66 gal/ft 5" diameter = 1.02 gal/ft 6" diameter = 1.50 gal/ft

MONITOR WELL DEVELOPMENT FIELD FORM

FLUID LEVEL DATA

Well ID 624-02 Date Gauged 11-10-23
 Site Dominquez 1 Time Gauged 14:36
 Depth to PSH _____ feet Well Diameter 4 inches
 Depth to Water 22.09 feet Height of Fluid Column 15.34 feet
 Total Depth 37.43 feet Volume in Well 10.124 gallons
 (3 Well Volumes = 30.37 gallons)

GROUNDWATER SAMPLING DATA

Time/date Purged 14:45 11-10-23 Purged Method Pump

Time	Purge Vol (gal)	Cumul Purge Vol (gal)	Temp (°C)	SpC (µs/cm)	pH	ORP (mV)	DO (mg/L)
15:07	10	10	18.3	4112	7.48	183	1.77
15:28	10	20	19.2	4035	7.33		
15:52	11	31	19.1	4060	7.25		

Actual Purge Volume 36 gals Field Measurements stabilized within ± 10% Y
 Time/Date Sampled 16:22 11-10-23 Purged/Sampled By AN
 Sample Method Pump
 Requested Analyses _____
 Comments/Observations _____

Well Casing Volumes
 2" diameter = 0.17 gal/ft 4" diameter = 0.66 gal/ft 5" diameter = 1.02 gal/ft 6" diameter = 1.50 gal/ft

MONITOR WELL DEVELOPMENT FIELD FORM

FLUID LEVEL DATA

Well ID 62409 Date Gauged 11-15-23
 Site Dominique 1 Time Gauged 9:21
 Depth to PSH _____ feet Well Diameter 2 inches
 Depth to Water 26.18 feet Height of Fluid Column 6.62 feet
 Total Depth 32.80 feet Volume in Well 1.125 gallons
 (3 Well Volumes = 3.37 gallons)

GROUNDWATER SAMPLING DATA

Time/date Purged 9:26 11-15-23 Purged Method Bail

Time	Purge Vol (gal)	Cumul Purge Vol (gal)	Temp (°C)	SpC (µs/cm)	pH	ORP (mV)	DO (mg/L)
9:34	1	1	20.9	2709	7.83	158	2.06
9:42	1	2	20.8	2670	7.61		
9:55	1.50	3.50	20.7	2631	7.42		
9:58	.25	3.75	20.7	2622	7.38		

Actual Purge Volume 6.5 gals Field Measurements stabilized within ± 10% Y
 Time/Date Sampled 10:30 11-15-23 Purged/Sampled By A.W
 Sample Method Bail
 Requested Analyses _____
 Comments/Observations _____

Well Casing Volumes

2" diameter = 0.17 gal/ft 4" diameter = 0.66 gal/ft 5" diameter = 1.02 gal/ft 6" diameter = 1.50 gal/ft

MONITOR WELL DEVELOPMENT FIELD FORM

FLUID LEVEL DATA

Well ID 624-10 Date Gauged 11-15-23
 Site Dominique 21 Time Gauged 10:53

Depth to PSH _____ feet Well Diameter 2 inches
 Depth to Water 27.29 feet Height of Fluid Column 10.05 feet
 Total Depth 37.34 feet Volume in Well 1.708 gallons
 (3 Well Volumes = 5.12 gallons)

GROUNDWATER SAMPLING DATA

Time/date Purged 10:58 11-15-23 Purged Method Pump

Time	Purge Vol (gal)	Cumul Purge Vol (gal)	Temp (°C)	SpC (µs/cm)	pH	ORP (mV)	DO (mg/L)
11:13	2	2	19.4	4087	7.70	172	1.83
11:23	2	4	19.3	4133	7.52		
11:33	2	6	19.3	4206	7.33		
11:37	2.25	6.25	19.5	4220	7.29		

Actual Purge Volume 8 gals Field Measurements stabilized within ± 10% Y
 Time/Date Sampled 11:52 11-15-23 Purged/Sampled By A.N
 Sample Method Pump
 Requested Analyses _____
 Comments/Observations _____

Well Casing Volumes

2" diameter = 0.17 gal/ft 4" diameter = 0.66 gal/ft 5" diameter = 1.02 gal/ft 6" diameter = 1.50 gal/ft

MONITOR WELL DEVELOPMENT FIELD FORM

FLUID LEVEL DATA

Well ID 624-11 Date Gauged 11-10-23
 Site Dominquez Time Gauged 10:23
 Depth to PSH _____ feet Well Diameter 2 inches
 Depth to Water 56.39 feet Height of Fluid Column 12.51 feet
 Total Depth 68.90 feet Volume in Well 2.126 gallons
 (3 Well Volumes = 6.38 gallons)

GROUNDWATER SAMPLING DATA

Time/date Purged 10:29 11-10-23 Purged Method Pump

Time	Purge Vol (gal)	Cumul Purge Vol (gal)	Temp (°C)	SpC (µs/cm)	pH	ORP (mV)	DO (mg/L)
10:45	2	2	19.6	6676	7.57	203	2.42
11:05	2	4	19.8	6627	7.43		
11:27	3	7	20.5	6573	7.29		

Actual Purge Volume 10 gals Field Measurements stabilized within ± 10% Y
 Time/Date Sampled 11:50 11-10-23 Purged/Sampled By A.N
 Sample Method Pump
 Requested Analyses _____
 Comments/Observations _____

Well Casing Volumes
 2" diameter = 0.17 gal/ft 4" diameter = 0.66 gal/ft 5" diameter = 1.02 gal/ft 6" diameter = 1.50 gal/ft

MONITOR WELL DEVELOPMENT FIELD FORM

FLUID LEVEL DATA

Well ID 42-02 Date Gauged 11-16-23
 Site Dominique 2 Time Gauged 13:20

Depth to PSH _____ feet Well Diameter 4 inches
 Depth to Water 31.13 feet Height of Fluid Column 34.17 feet
 Total Depth 65.30 feet Volume in Well 22.55 gallons
 (3 Well Volumes = 67.65 gallons)

GROUNDWATER SAMPLING DATA

Time/date Purged 13:25 11-16-23 Purged Method Pump

Time	Purge Vol (gal)	Cumul Purge Vol (gal)	Temp (°C)	SpC (µs/cm)	pH	ORP (mV)	DO (mg/L)
13:53	25	25	19.7	3779	7.21	209	2.91
14:20	25	50	19.9	3815	7.24		
14:47	18	68	20.2	3767	7.29		

Actual Purge Volume 73 gals Field Measurements stabilized within ± 10% Y
 Time/Date Sampled 15:00 11-16-23 Purged/Sampled By A.N
 Sample Method Pump
 Requested Analyses _____
 Comments/Observations _____

Well Casing Volumes
 2" diameter = 0.17 gal/ft 4" diameter = 0.66 gal/ft 5" diameter = 1.02 gal/ft 6" diameter = 1.50 gal/ft

MONITOR WELL DEVELOPMENT FIELD FORM

FLUID LEVEL DATA

Well ID 42-03 Date Gauged 11-16-23
 Site Dominquez 2 Time Gauged 9:15
 Depth to PSH _____ feet Well Diameter 4 inches
 Depth to Water 88.04 feet Height of Fluid Column 9.16 feet
 Total Depth 97.20 feet Volume in Well 6.045 gallons
 (3 Well Volumes = 18.13 gallons)

GROUNDWATER SAMPLING DATA

Time/date Purged 9:23 11-16-23 Purged Method Pump

Time	Purge-Vol (gal)	Cumul Purge Vol (gal)	Temp (°C)	SpC (µs/cm)	pH	ORP (mV)	DO (mg/L)
9:47	6	6	25.0	4944	6.60	209	1.98
10:10	6	12	25.6	4922	7.10		
10:26	6.25	18.25	25.7	4905	7.20		

Actual Purge Volume 24 gals Field Measurements stabilized within ± 10% Y
 Time/Date Sampled 10:47 11-16-23 Purged/Sampled By A-W
 Sample Method Pump
 Requested Analyses _____
 Comments/Observations _____

Well Casing Volumes
 2" diameter = 0.17 gal/ft 4" diameter = 0.66 gal/ft 5" diameter = 1.02 gal/ft 6" diameter = 1.50 gal/ft

MONITOR WELL DEVELOPMENT FIELD FORM

FLUID LEVEL DATA

Well ID 42-06 Date Gauged 11-16-23
 Site Dominique 2 Time Gauged 15:58
 Depth to PSH _____ feet Well Diameter 4 inches
 Depth to Water 37.52 feet Height of Fluid Column 4.03 feet
 Total Depth 41.55 feet Volume in Well 2.659 gallons
 (3 Well Volumes = 7.97 gallons)

GROUNDWATER SAMPLING DATA

Time/date Purged 16:07 11-16-23 Purged Method Pump

Time	Purge Vol (gal)	Cumul Purge Vol (gal)	Temp (°C)	SpC (µs/cm)	pH	ORP (mV)	DO (mg/L)
16:20	3	3	20.9	3251	7.69	252	2.43
16:32	3	6	20.7	3227	7.38		
16:40	2	8	20.8	3191	7.32		

Actual Purge Volume 11 gals Field Measurements stabilized within ± 10% Y
 Time/Date Sampled 17:00 11-16-23 Purged/Sampled By A.N
 Sample Method Pump
 Requested Analyses _____
 Comments/Observations _____

Well Casing Volumes
 2" diameter = 0.17 gal/ft 4" diameter = 0.66 gal/ft 5" diameter = 1.02 gal/ft 6" diameter = 1.50 gal/ft

MONITOR WELL DEVELOPMENT FIELD FORM

FLUID LEVEL DATA

Well ID 42-08 Date Gauged 11-16-23
 Site Dominion 2 Time Gauged 15:05
 Depth to PSH _____ feet Well Diameter 4 inches
 Depth to Water 33.66 feet Height of Fluid Column 1.44 feet
 Total Depth 35.10 feet Volume in Well 0.950 gallons
 (3 Well Volumes = 2.85 gallons)

GROUNDWATER SAMPLING DATA

Time/date Purged 15:11 11-16-23 Purged Method Pump

Time	Purge Vol (gal)	Cumul Purge Vol (gal)	Temp (°C)	SpC (µs/cm)	pH	ORP (mV)	DO (mg/L)
15:25	22	22	20.5	3883	7.53	181	1.74

Actual Purge Volume 23 gals Field Measurements stabilized within ± 10% ✓
 Time/Date Sampled 15:41 11-16-23 Purged/Sampled By A.N
 Sample Method Pump
 Requested Analyses _____
 Comments/Observations well stopped pumping out water at 2 gals
was able to collect sample. No water recovery

Well Casing Volumes
 2" diameter = 0.17 gal/ft 4" diameter = 0.66 gal/ft 5" diameter = 1.02 gal/ft 6" diameter = 1.50 gal/ft

MONITOR WELL DEVELOPMENT FIELD FORM

FLUID LEVEL DATA

Well ID 42-10 Date Gauged 11-15-23
 Site Dominique 2 Time Gauged 16:08

Depth to PSH _____ feet Well Diameter 4 inches
 Depth to Water 120.07 feet Height of Fluid Column 3.53 feet
 Total Depth 123.60 feet Volume in Well 2.329 gallons
 (3 Well Volumes = 6.98 gallons)

GROUNDWATER SAMPLING DATA

Time/date Purged 16:12 11-15-23 Purged Method Pump

Time	Purge Vol (gal)	Cumul Purge Vol (gal)	Temp (°C)	SpC (µs/cm)	pH	ORP (mV)	DO (mg/L)
16:45	22	22	25.7	4322	7.34	136	1.80
17:15	23	23	23.7	4010	7.27		

Actual Purge Volume 23 gals Field Measurements stabilized within ± 10% ✓

Time/Date Sampled N/A N/A Purged/Sampled By A. J.

Sample Method N/A

Requested Analyses _____

Comments/Observations low water flow. Pumped out less than 2 gals, not enough water for sample, left pump running for 15-20 mins no water coming out. stop at 17:40

Well Casing Volumes
 2" diameter = 0.17 gal/ft 4" diameter = 0.66 gal/ft 5" diameter = 1.02 gal/ft 6" diameter = 1.50 gal/ft

MONITOR WELL DEVELOPMENT FIELD FORM

FLUID LEVEL DATA

Well ID 42-11 Date Gauged 11-15-23
 Site Dominquez 2 Time Gauged 12:45

Depth to PSH _____ feet Well Diameter 4 inches
 Depth to Water 130.86 feet Height of Fluid Column 2.64 feet
 Total Depth 133.50 feet Volume in Well 1.742 gallons

(3 Well Volumes = 5.22 gallons)

GROUNDWATER SAMPLING DATA

Time/date Purged 12:51 11-15-23 Purged Method Pump

Time	Purge Vol (gal)	Cumul Purge Vol (gal)	Temp (°C)	SpC (µs/cm)	pH	ORP (mV)	DO (mg/L)
13:35	2	2	24.1	2814	7.60	156	2.12
13:52	43	43	24.5	2947	7.47		

Actual Purge Volume 43 gals Field Measurements stabilized within ± 10% N

Time/Date Sampled 14:30 11-15-23 Purged/Sampled By A-N

Sample Method Pump

Requested Analyses _____

Comments/Observations Very low water flow. No water coming out after 2 gals. was able to collect samples after running pump for 10-15 mins. very minimal water coming out.

Well Casing Volumes
 2" diameter = 0.17 gal/ft 4" diameter = 0.66 gal/ft 5" diameter = 1.02 gal/ft 6" diameter = 1.50 gal/ft

MONITOR WELL DEVELOPMENT FIELD FORM

FLUID LEVEL DATA

Well ID 42-12 Date Gauged 11-15-23
 Site Dominicus 2 Time Gauged 14:43
 Depth to PSH _____ feet Well Diameter 4 inches
 Depth to Water 137.19 feet Height of Fluid Column 2.25 feet
 Total Depth 139.44 feet Volume in Well 1.485 gallons
 (3 Well Volumes = 4.45 gallons)

GROUNDWATER SAMPLING DATA

Time/date Purged 14:50 11-15-23 Purged Method Pump

Time	Purge Vol (gal)	Cumul Purge Vol (gal)	Temp (°C)	SpC (µs/cm)	pH	ORP (mV)	DO (mg/L)
15:22	2	2	24.7	1793	7.83	120	1.29
15:34	3	3	24.6	1771	7.66		

Actual Purge Volume 3 gals Field Measurements stabilized within ± 10% N
 Time/Date Sampled N/A N/A Purged/Sampled By A-N
 Sample Method Pump N/A
 Requested Analyses _____

Comments/Observations Water flow low. Only pumped out close to gals, no water coming out anymore. No sample collected. Stop pump at 15:51 to see if I could collect water sample.

Well Casing Volumes
 2" diameter = 0.17 gal/ft 4" diameter = 0.66 gal/ft 5" diameter = 1.02 gal/ft 6" diameter = 1.50 gal/ft

Chain-of-Custody Record

Client:

EA Engineering, Science, and Technology

Mailing Address:

320 Gold Ave SW Suite

Phone #: 505-715-4279

email or Fax#: rmullen@east.com

QA/QC Package:

Standard Level 4 (Full Validation)

Accreditation: Az Compliance

NELAC Other

EDD (Type)

Turn-Around Time:

Standard Rush

Project Name:

Project #:

Mountain View Dairy

Project Manager:

Gina Mullen

Sampler: Angel N. Rivera

On Ice: Yes No

of Coolers:

Cooler Temp (including CP):

Container Type and #

Preservative Type

HEAL No.

Date: 12-15

Time: 10:00

Matrix: Lagoon

Sample Name: 70-Lagoon

2

Date: 12-15

Time: 17:15

Relinquished by:

Refiniquished by:

Received by:

Via:

Date Time

Date: 12-15

Time: 17:15

Relinquished by:

Refiniquished by:

Received by:

Via:

Date Time

Remarks:

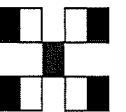

**HALL ENVIRONMENTAL
ANALYSIS LABORATORY**

www.hallenvironmental.com

4901 Hawkins NE - Albuquerque, NM 87109

Tel. 505-345-3975 Fax 505-345-4107

Analysis Request

<input checked="" type="checkbox"/>	Nitrate/Nitrites EPA Method 300
<input checked="" type="checkbox"/>	TKN SM 4500 NORG C
<input checked="" type="checkbox"/>	Chloride EPA 300
<input checked="" type="checkbox"/>	TDS SM 2540 C MOD
	Sulfate EPA 300
	Phosphorus EPA 6010B
<input checked="" type="checkbox"/>	Total Sulfur

If necessary, samples submitted to Hall Environmental may be subcontracted to other accredited laboratories. This serves as notice of this possibility. Any sub-contracted data will be clearly notated on the analytical report.

MONITOR WELL DEVELOPMENT FIELD FORM

FLUID LEVEL DATA

Well ID 70-01 Date Gauged 11-9-23
 Site Mountain View Time Gauged 12:09
 Depth to PSH _____ feet Well Diameter 4 inches
 Depth to Water 41.04 feet Height of Fluid Column 4.91 feet
 Total Depth 45.95 feet Volume in Well 3.240 gallons
 (3 Well Volumes = 9.72 gallons)

GROUNDWATER SAMPLING DATA

Time/date Purged 12:17 11-9-23 Purged Method Pump

Time	Purge Vol (gal)	Cumul Purge Vol (gal)	Temp (°C)	SpC (µs/cm)	pH	ORP (mV)	DO (mg/L)
12:33	3	3	21.6	4720	7.45	174	2.79
12:54	3	6	20.8	4730	7.32		
13:30	4	10	21.2	4702	7.26		

Actual Purge Volume 13 gals Field Measurements stabilized within ± 10% Y
 Time/Date Sampled 13:53 11-9-23 Purged/Sampled By A.N
 Sample Method Pump
 Requested Analyses _____
 Comments/Observations _____

Well Casing Volumes
 2" diameter = 0.17 gal/ft 4" diameter = 0.66 gal/ft 5" diameter = 1.02 gal/ft 6" diameter = 1.50 gal/ft

MONITOR WELL DEVELOPMENT FIELD FORM

FLUID LEVEL DATA

Well ID 70-03 Date Gauged 11-9-23
 Site Mountain View Time Gauged 14:42
 Depth to PSH _____ feet Well Diameter 4 inches
 Depth to Water 60.56 feet Height of Fluid Column 1.09 feet
 Total Depth 61.65 feet Volume in Well 0.719 gallons
 (3 Well Volumes = 2.15 gallons)

GROUNDWATER SAMPLING DATA

Time/date Purged 14:47 11-9-23 Purged Method Bail

Time	Purge Vol (gal)	Cumul Purge Vol (gal)	Temp (°C)	SpC (µs/cm)	pH	ORP (mV)	DO (mg/L)
15:01	.50	.50	21.0	6971	7.53	169	1.55
15:13	1	1.50	20.9	7003	7.36		
15:36	1	2.50	21.2	7011	7.28		

Actual Purge Volume 5 gals Field Measurements stabilized within ± 10% Y
 Time/Date Sampled 16:00 11-9-23 Purged/Sampled By A.N
 Sample Method Bail
 Requested Analyses _____
 Comments/Observations Very low water flow. Well dry out at 4
gals. Slow water recovery.

Well Casing Volumes
 2" diameter = 0.17 gal/ft 4" diameter = 0.66 gal/ft 5" diameter = 1.02 gal/ft 6" diameter = 1.50 gal/ft

MONITOR WELL DEVELOPMENT FIELD FORM

FLUID LEVEL DATA

Well ID 70-04 Date Gauged 11-9-23
 Site Mountain View Time Gauged 9:41
 Depth to PSH _____ feet Well Diameter 2 inches
 Depth to Water 38.80 feet Height of Fluid Column 9.05 feet
 Total Depth 47.85 feet Volume in Well 1.538 gallons
 (3 Well Volumes = 4.61 gallons)

GROUNDWATER SAMPLING DATA

Time/date Purged 9:47 11-9-23 Purged Method Bail

Time	Purge Vol (gal)	Cumul Purge Vol (gal)	Temp (°C)	SpC (µs/cm)	pH	ORP (mV)	DO (mg/L)
9:56	1.50	1.50	21.8	4458	7.82	182	2.39
10:07	1.50	3	21.9	4479	7.66		
10:23	2	5	21.6	4503	7.41		
10:25	.25	5.25	21.7	4517	7.30		

Actual Purge Volume 7 gals Field Measurements stabilized within ± 10% Y
 Time/Date Sampled 10:48 11-9-23 Purged/Sampled By A.W
 Sample Method Bail
 Requested Analyses _____
 Comments/Observations _____

Well Casing Volumes
 2" diameter = 0.17 gal/ft 4" diameter = 0.66 gal/ft 5" diameter = 1.02 gal/ft 6" diameter = 1.50 gal/ft

Organ Dairy
 Mesquite, NM

Field Parameters and Sample Results for Monitoring wells 4th Quarter 2023

NS- Well bailed dry, insufficient amount of water to sample. NS- Well turned off / Barn being dismantled . NA- Meter Damaged.*

Well ID	Sampling Date	Depth to water (ft)	EC (μS/cm)	pH	Temp (°C)	DO (mg/L)	ORP (mv)
MW 126-04	11/20/2023	38.09	NS	NS	NS	NS	NS
MW 126-05	11/20/2023	30.70	NS	NS	NS	NS	NS
MW 126-07	11/20/2023	Dry	NS	NS	NS	NS	NS
MW 126-09	11/20/2023	Dry	NS	NS	NS	NS	NS
MW 126-12	11/20/2023	26.80	3383	7.01	19.9	NA	69
MW 126-13	11/20/2023	46.05	NA	6.79	21.5	NA	173
LRG-458S	11/8/2022	NS*	NS*	NS*	NS*	NS*	NS*

MONITOR WELL DEVELOPMENT FIELD FORM

FLUID LEVEL DATA

Well ID 257-01 Date Gauged 11-28-23
 Site Sunset Dairy Time Gauged 10:15
 Depth to PSH _____ feet Well Diameter 2 inches
 Depth to Water 23.28 feet Height of Fluid Column 2.57 feet
 Total Depth 25.85 feet Volume in Well 0.436 gallons
 (3 Well Volumes = 1.31 gallons)

GROUNDWATER SAMPLING DATA

Time/date Purged 10:20 11-28-23 Purged Method Bail

Time	Purge Vol (gal)	Cumul Purge Vol (gal)	Temp (°C)	SpC (µs/cm)	pH	ORP (mV)	DO (mg/L)
10:26	.50	.50	19.7	5502	7.08	205	1.44
10:32	.50	1	19.3	5475	7.14		
10:39	.50	1.50	19.5	5411	7.18		

Actual Purge Volume 3 gals Field Measurements stabilized within ± 10% Y
 Time/Date Sampled 11:00 11-28-23 Purged/Sampled By AW
 Sample Method Bail
 Requested Analyses _____
 Comments/Observations _____

Well Casing Volumes
 2" diameter = 0.17 gal/ft 4" diameter = 0.66 gal/ft 5" diameter = 1.02 gal/ft 6" diameter = 1.50 ga/ft

MONITOR WELL DEVELOPMENT FIELD FORM

FLUID LEVEL DATA

Well ID 257-02 Date Gauged 11-28-23
 Site Sunset Drim Time Gauged 11:18

Depth to PSH _____ feet Well Diameter 2 inches
 Depth to Water 16.97 feet Height of Fluid Column 3.89 feet
 Total Depth 20.86 feet Volume in Well 0.661 gallons
 (3 Well Volumes = 1.98 gallons)

GROUNDWATER SAMPLING DATA

Time/date Purged 11:26 11-28-23 Purged Method Bail

Time	Purge Vol (gal)	Cumul Purge Vol (gal)	Temp (°C)	SpC (µs/cm)	pH	ORP (mV)	DO (mg/L)
11:35	.50	.50	19.0	4253	7.40	1.40	2.31
11:42	.50	1	20.3	3795	7.30		
11:51	1	2	20.5	3818	7.25		

Actual Purge Volume 4 gals Field Measurements stabilized within ± 10% Y
 Time/Date Sampled 12:25 11-28-23 Purged/Sampled By A.N
 Sample Method Bail
 Requested Analyses _____
 Comments/Observations _____

Well Casing Volumes
 2" diameter = 0.17 gal/ft 4" diameter = 0.66 gal/ft 5" diameter = 1.02 gal/ft 6" diameter = 1.50 ga/ft

MONITOR WELL DEVELOPMENT FIELD FORM

FLUID LEVEL DATA

Well ID MW-4 Date Gauged 11-28-23
 Site Sunset Dairy Time Gauged 13:08

Depth to PSH _____ feet Well Diameter 2 inches
 Depth to Water 33.31 feet Height of Fluid Column 6.64 feet
 Total Depth 39.95 feet Volume in Well 1.128 gallons
 (3 Well Volumes = 3.38 gallons)

GROUNDWATER SAMPLING DATA

Time/date Purged 13:15 11-28-23 Purged Method Bail

Time	Purge Vol (gal)	Cumul Purge Vol (gal)	Temp (°C)	SpC (µs/cm)	pH	ORP (mV)	DO (mg/L)
13:27	1	1	21.3	6620	7.63	188	2.55
13:38	1	2	21.5	6666	7.40		
13:53	1.50	3.50	21.2	6565	7.31		
13:55	.25	3.75	21.4	6542	7.27		

Actual Purge Volume 6.50 gals Field Measurements stabilized within ± 10% Y
 Time/Date Sampled 14:45 11-28-23 Purged/Sampled By A.N
 Sample Method Bail
 Requested Analyses _____
 Comments/Observations _____

Well Casing Volumes
 2" diameter = 0.17 gal/ft 4" diameter = 0.66 gal/ft 5" diameter = 1.02 gal/ft 6" diameter = 1.50 gal/ft

APPENDIX C

ANALYTICAL LABORATORY REPORTS

(Provided in Electronic Format via CD Located on Front Cover of Report)

December 20, 2023

Samantha Carver

Glorieta GeoScience A Divison of GZA

P.O. Box 5727

Santa Fe, NM 87502

TEL: (505) 983-5446

FAX: (505) 983-6482

RE: Organ Dairy

OrderNo.: 2311A32

Dear Samantha Carver:

Eurofins Environment Testing South Central, LLC received 2 sample(s) on 11/20/2023 for the analyses presented in the following report.

These were analyzed according to EPA procedures or equivalent. To access our accredited tests please go to www.hallenvironmental.com or the state specific web sites. In order to properly interpret your results, it is imperative that you review this report in its entirety. See the sample checklist and/or the Chain of Custody for information regarding the sample receipt temperature and preservation. Data qualifiers or a narrative will be provided if the sample analysis or analytical quality control parameters require a flag. When necessary, data qualifiers are provided on both the sample analysis report and the QC summary report, both sections should be reviewed. All samples are reported, as received, unless otherwise indicated. Lab measurement of analytes considered field parameters that require analysis within 15 minutes of sampling such as pH and residual chlorine are qualified as being analyzed outside of the recommended holding time.

Please do not hesitate to contact Eurofins Albuquerque for any additional information or clarifications.

ADHS Cert #AZ0682 -- NMED-DWB Cert #NM9425 -- NMED-Micro Cert #NM0901

Sincerely,



Andy Freeman

Laboratory Manager

4901 Hawkins NE

Albuquerque, NM 87109

Hall Environmental Analysis Laboratory, Inc.

Analytical Report

Lab Order 2311A32

Date Reported: 12/20/2023

CLIENT: Glorieta GeoScience A Divison of GZA

Client Sample ID: MW 126-12

Project: Organ Dairy

Collection Date: 11/19/2023 10:00:00 AM

Lab ID: 2311A32-001

Matrix: AQUEOUS

Received Date: 11/20/2023 10:47:00 AM

Analyses	Result	RL	Qual	Units	DF	Date Analyzed	Batch
EPA METHOD 300.0: ANIONS							Analyst: JMT
Chloride	430	50	*	mg/L	100	11/20/2023 6:11:33 PM	R101323
Nitrogen, Nitrate (As N)	3.8	1.0		mg/L	10	11/20/2023 5:33:00 PM	R101323
Sulfate	500	50	*	mg/L	100	11/20/2023 6:11:33 PM	R101323
SM2540C MOD: TOTAL DISSOLVED SOLIDS							Analyst: MCA
Total Dissolved Solids	2140	100	*D	mg/L	1	11/28/2023 8:29:00 AM	78947
EPA 351.2: TKN							Analyst: DML
Nitrogen, Kjeldahl, Total	0.64	0.50		mg/L	1	12/13/2023 6:38:29 PM	79343

Refer to the QC Summary report and sample login checklist for flagged QC data and preservation information.

Qualifiers:	*	Value exceeds Maximum Contaminant Level.	B	Analyte detected in the associated Method Blank
	D	Sample Diluted Due to Matrix	E	Above Quantitation Range/Estimated Value
	H	Holding times for preparation or analysis exceeded	J	Analyte detected below quantitation limits
	ND	Not Detected at the Reporting Limit	P	Sample pH Not In Range
	PQL	Practical Quantitative Limit	RL	Reporting Limit
	S	% Recovery outside of standard limits. If undiluted results may be estimated.		

Hall Environmental Analysis Laboratory, Inc.

Analytical Report

Lab Order 2311A32

Date Reported: 12/20/2023

CLIENT: Glorieta GeoScience A Divison of GZA

Client Sample ID: MW 126-13

Project: Organ Dairy

Collection Date: 11/19/2023 10:50:00 AM

Lab ID: 2311A32-002

Matrix: AQUEOUS

Received Date: 11/20/2023 10:47:00 AM

Analyses	Result	RL	Qual	Units	DF	Date Analyzed	Batch
EPA METHOD 300.0: ANIONS							Analyst: JMT
Chloride	710	50	*	mg/L	100	11/20/2023 6:37:18 PM	R101323
Nitrogen, Nitrate (As N)	14	1.0	*	mg/L	10	11/20/2023 6:24:26 PM	R101323
Sulfate	790	50	*	mg/L	100	11/20/2023 6:37:18 PM	R101323
SM2540C MOD: TOTAL DISSOLVED SOLIDS							Analyst: MCA
Total Dissolved Solids	3110	250	*D	mg/L	1	11/28/2023 8:29:00 AM	78947
EPA 351.2: TKN							Analyst: DML
Nitrogen, Kjeldahl, Total	0.76	0.50		mg/L	1	12/13/2023 6:39:59 PM	79343

Refer to the QC Summary report and sample login checklist for flagged QC data and preservation information.

Qualifiers:	*	Value exceeds Maximum Contaminant Level.	B	Analyte detected in the associated Method Blank
	D	Sample Diluted Due to Matrix	E	Above Quantitation Range/Estimated Value
	H	Holding times for preparation or analysis exceeded	J	Analyte detected below quantitation limits
	ND	Not Detected at the Reporting Limit	P	Sample pH Not In Range
	PQL	Practical Quantitative Limit	RL	Reporting Limit
	S	% Recovery outside of standard limits. If undiluted results may be estimated.		

QC SUMMARY REPORT

Hall Environmental Analysis Laboratory, Inc.

WO#: 2311A32

20-Dec-23

Client: Glorieta GeoScience A Divison of GZA
Project: Organ Dairy

Sample ID: MB	SampType: mblk	TestCode: EPA Method 300.0: Anions								
Client ID: PBW	Batch ID: R101323	RunNo: 101323								
Prep Date:	Analysis Date: 11/20/2023	SeqNo: 3726971			Units: mg/L					
Analyte	Result	PQL	SPK value	SPK Ref Val	%REC	LowLimit	HighLimit	%RPD	RPDLimit	Qual

Chloride	ND	0.50								
Nitrogen, Nitrate (As N)	ND	0.10								
Sulfate	ND	0.50								

Sample ID: LCS	SampType: lcs	TestCode: EPA Method 300.0: Anions								
Client ID: LCSW	Batch ID: R101323	RunNo: 101323								
Prep Date:	Analysis Date: 11/20/2023	SeqNo: 3726972			Units: mg/L					
Analyte	Result	PQL	SPK value	SPK Ref Val	%REC	LowLimit	HighLimit	%RPD	RPDLimit	Qual

Chloride	4.8	0.50	5.000	0	95.7	90	110			
Nitrogen, Nitrate (As N)	2.5	0.10	2.500	0	98.9	90	110			
Sulfate	9.6	0.50	10.00	0	96.1	90	110			

Sample ID: 2311A32-001AMS	SampType: ms	TestCode: EPA Method 300.0: Anions								
Client ID: MW 126-12	Batch ID: R101323	RunNo: 101323								
Prep Date:	Analysis Date: 11/20/2023	SeqNo: 3727013			Units: mg/L					
Analyte	Result	PQL	SPK value	SPK Ref Val	%REC	LowLimit	HighLimit	%RPD	RPDLimit	Qual

Nitrogen, Nitrate (As N)	28	1.0	25.00	3.793	96.4	80	120			
--------------------------	----	-----	-------	-------	------	----	-----	--	--	--

Sample ID: 2311A32-001AMSD	SampType: msd	TestCode: EPA Method 300.0: Anions								
Client ID: MW 126-12	Batch ID: R101323	RunNo: 101323								
Prep Date:	Analysis Date: 11/20/2023	SeqNo: 3727015			Units: mg/L					
Analyte	Result	PQL	SPK value	SPK Ref Val	%REC	LowLimit	HighLimit	%RPD	RPDLimit	Qual

Nitrogen, Nitrate (As N)	29	1.0	25.00	3.793	101	80	120	4.38	20	
--------------------------	----	-----	-------	-------	-----	----	-----	------	----	--

Qualifiers:

- * Value exceeds Maximum Contaminant Level.
- D Sample Diluted Due to Matrix
- H Holding times for preparation or analysis exceeded
- ND Not Detected at the Reporting Limit
- PQL Practical Quantitative Limit
- S % Recovery outside of standard limits. If undiluted results may be estimated.
- B Analyte detected in the associated Method Blank
- E Above Quantitation Range/Estimated Value
- J Analyte detected below quantitation limits
- P Sample pH Not In Range
- RL Reporting Limit

QC SUMMARY REPORT

Hall Environmental Analysis Laboratory, Inc.

WO#: 2311A32

20-Dec-23

Client: Glorieta GeoScience A Divison of GZA
Project: Organ Dairy

Sample ID: MB-78947	SampType: MBLK	TestCode: SM2540C MOD: Total Dissolved Solids								
Client ID: PBW	Batch ID: 78947	RunNo: 101428								
Prep Date: 11/22/2023	Analysis Date: 11/28/2023	SeqNo: 3732122	Units: mg/L							
Analyte	Result	PQL	SPK value	SPK Ref Val	%REC	LowLimit	HighLimit	%RPD	RPDLimit	Qual
Total Dissolved Solids	ND	50.0								

Sample ID: LCS-78947	SampType: LCS	TestCode: SM2540C MOD: Total Dissolved Solids								
Client ID: LCSW	Batch ID: 78947	RunNo: 101428								
Prep Date: 11/22/2023	Analysis Date: 11/28/2023	SeqNo: 3732123	Units: mg/L							
Analyte	Result	PQL	SPK value	SPK Ref Val	%REC	LowLimit	HighLimit	%RPD	RPDLimit	Qual
Total Dissolved Solids	1060	50.0	1000	0	106	80	120			

Qualifiers:

- * Value exceeds Maximum Contaminant Level.
- D Sample Diluted Due to Matrix
- H Holding times for preparation or analysis exceeded
- ND Not Detected at the Reporting Limit
- PQL Practical Quantitative Limit
- S % Recovery outside of standard limits. If undiluted results may be estimated.
- B Analyte detected in the associated Method Blank
- E Above Quantitation Range/Estimated Value
- J Analyte detected below quantitation limits
- P Sample pH Not In Range
- RL Reporting Limit

QC SUMMARY REPORT

Hall Environmental Analysis Laboratory, Inc.

WO#: 2311A32

20-Dec-23

Client: Glorieta GeoScience A Divison of GZA

Project: Organ Dairy

Sample ID: MB-79343	SampType: MBLK	TestCode: EPA 351.2: TKN								
Client ID: PBW	Batch ID: 79343	RunNo: 101810								
Prep Date: 12/13/2023	Analysis Date: 12/13/2023	SeqNo: 3753176	Units: mg/L							
Analyte	Result	PQL	SPK value	SPK Ref Val	%REC	LowLimit	HighLimit	%RPD	RPDLimit	Qual
Nitrogen, Kjeldahl, Total	ND	0.50								

Sample ID: LCSLL-79343	SampType: LCSLL	TestCode: EPA 351.2: TKN								
Client ID: BatchQC	Batch ID: 79343	RunNo: 101810								
Prep Date: 12/13/2023	Analysis Date: 12/13/2023	SeqNo: 3753177	Units: mg/L							
Analyte	Result	PQL	SPK value	SPK Ref Val	%REC	LowLimit	HighLimit	%RPD	RPDLimit	Qual
Nitrogen, Kjeldahl, Total	0.50	0.50	0.5000	0	101	50	150			

Sample ID: LCS-79343	SampType: LCS	TestCode: EPA 351.2: TKN								
Client ID: LCSW	Batch ID: 79343	RunNo: 101810								
Prep Date: 12/13/2023	Analysis Date: 12/13/2023	SeqNo: 3753178	Units: mg/L							
Analyte	Result	PQL	SPK value	SPK Ref Val	%REC	LowLimit	HighLimit	%RPD	RPDLimit	Qual
Nitrogen, Kjeldahl, Total	9.7	0.50	10.00	0	96.9	90	110			

Qualifiers:

- * Value exceeds Maximum Contaminant Level.
- D Sample Diluted Due to Matrix
- H Holding times for preparation or analysis exceeded
- ND Not Detected at the Reporting Limit
- PQL Practical Quantitative Limit
- S % Recovery outside of standard limits. If undiluted results may be estimated.
- B Analyte detected in the associated Method Blank
- E Above Quantitation Range/Estimated Value
- J Analyte detected below quantitation limits
- P Sample pH Not In Range
- RL Reporting Limit

Sample Log-In Check List

Client Name: **Glorieta GeoScience A** Work Order Number: **2311A32** RcptNo: **1**

Received By: **Steve McQuiston** 11/20/2023 10:47:00 AM *Steve McQuiston*

Completed By: **Desiree Dominguez** 11/20/2023 1:05:38 PM *DD*

Reviewed By: *gum/20/23*

Chain of Custody

1. Is Chain of Custody complete? Yes No Not Present
2. How was the sample delivered? Client

Log In

3. Was an attempt made to cool the samples? Yes No NA
4. Were all samples received at a temperature of >0° C to 6.0°C Yes No NA
5. Sample(s) in proper container(s)? Yes No
6. Sufficient sample volume for indicated test(s)? Yes No
7. Are samples (except VOA and ONG) properly preserved? Yes No
8. Was preservative added to bottles? Yes No NA
9. Received at least 1 vial with headspace <1/4" for AQ VOA? Yes No NA
10. Were any sample containers received broken? Yes No
11. Does paperwork match bottle labels?
(Note discrepancies on chain of custody) Yes No
12. Are matrices correctly identified on Chain of Custody? Yes No
13. Is it clear what analyses were requested? Yes No
14. Were all holding times able to be met?
(If no, notify customer for authorization.) Yes No

of preserved bottles checked for pH: 2
(2 or >12 unless noted)
Adjusted? NO
Checked by: SCM 11/20/23

Special Handling (if applicable)

15. Was client notified of all discrepancies with this order? Yes No NA

Person Notified: _____ Date: _____
By Whom: _____ Via: eMail Phone Fax In Person
Regarding: _____
Client Instructions: _____

16. Additional remarks:
Client e-mail/fax not provided on COC. -DAD 11/20/23

17. Cooler Information

Cooler No	Temp °C	Condition	Seal Intact	Seal No	Seal Date	Signed By
1	0.2	Good	Not Present	Morty		

Chain-of-Custody Record

Client: Albioneta Foods Science

Mailing Address: 1723 New St.

Santa Fe, NM, 87505

Phone #: 505 983 5446

email or Fax#:

QA/QC Package:

Standard Level 4 (Full Validation)

Accreditation: Az Compliance

NELAC Other

EDD (Type)

Turn-Around Time:

Standard Rush

Project Name:

Organ Dairy

Project #:

Project Manager:

Samantha Carver

Sampler: JStar

On Ice: Yes No

of Coolers: 1

Cooler Temp (including CF): 0.4-0.2=0.2 (°C)

Container Type and # 2x50ml Preservative Type H₂SO₄ HEAL No. 2311A32

Date	Time	Matrix	Sample Name	Container Type and #	Preservative Type	HEAL No.
<u>11/19/23</u>	<u>1000</u>	<u>A9</u>	<u>MIL 126-12</u>	<u>2x50ml</u>	<u>H₂SO₄</u>	<u>-001</u>
<u>↓</u>	<u>1050</u>	<u>↓</u>	<u>MIL 126-13</u>	<u>↓</u>	<u>↓</u>	<u>-002</u>

Date: 11/20/23 Time: 5:00 Relinquished by: [Signature]

Received by: SM Via: OD Date: 11/20/23 Time: 10:17

Date: 11/20/23 Time: 5:00 Relinquished by: [Signature]

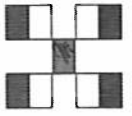

HALL ENVIRONMENTAL ANALYSIS LABORATORY

www.hallenvironmental.com

4901 Hawkins NE - Albuquerque, NM 87109

Tel. 505-345-3975 Fax 505-345-4107

Analysis Request

Remarks:	BTEX / MTBE / TMB's (8021)	TPH:8015D(GRO / DRO / MRO)	8081 Pesticides/8082 PCB's	EDB (Method 504.1)	PAHs by 8310 or 8270SIMS	RCRA 8 Metals	Cl, F, Br, NO ₃ , NO ₂ , PO ₄ , SO ₄	8260 (VOA)	8270 (Semi-VOA)	Total Coliform (Present/Absent)	TDS, Cl, SO ₄	TKN, NO ₃
											X	X
											X	X

If necessary, samples submitted to Hall Environmental may be subcontracted to other accredited laboratories. This serves as notice of this possibility. Any sub-contracted data will be clearly notated on the analytical report.

December 20, 2023

Regina Mullen
EA Engineering
320 Gold Ave SW Suite 1210
Albuquerque, NM 87102
TEL:
FAX:

RE: Buena Vista Dairy II

OrderNo.: 2311A13

Dear Regina Mullen:

Eurofins Environment Testing South Central, LLC received 5 sample(s) on 11/18/2023 for the analyses presented in the following report.

These were analyzed according to EPA procedures or equivalent. To access our accredited tests please go to www.hallenvironmental.com or the state specific web sites. In order to properly interpret your results, it is imperative that you review this report in its entirety. See the sample checklist and/or the Chain of Custody for information regarding the sample receipt temperature and preservation. Data qualifiers or a narrative will be provided if the sample analysis or analytical quality control parameters require a flag. When necessary, data qualifiers are provided on both the sample analysis report and the QC summary report, both sections should be reviewed. All samples are reported, as received, unless otherwise indicated. Lab measurement of analytes considered field parameters that require analysis within 15 minutes of sampling such as pH and residual chlorine are qualified as being analyzed outside of the recommended holding time.

Please do not hesitate to contact Eurofins Albuquerque for any additional information or clarifications.

ADHS Cert #AZ0682 -- NMED-DWB Cert #NM9425 -- NMED-Micro Cert #NM0901

Sincerely,



Andy Freeman
Laboratory Manager
4901 Hawkins NE
Albuquerque, NM 87109

Hall Environmental Analysis Laboratory, Inc.

Analytical Report

Lab Order 2311A13

Date Reported: 12/20/2023

CLIENT: EA Engineering

Client Sample ID: 74-03

Project: Buena Vista Dairy II

Collection Date: 11/17/2023 10:00:00 AM

Lab ID: 2311A13-001

Matrix: GROUNDWA

Received Date: 11/18/2023 11:00:00 AM

Analyses	Result	RL	Qual	Units	DF	Date Analyzed	Batch
EPA METHOD 300.0: ANIONS							Analyst: SNS
Chloride	220	50		mg/L	100	11/27/2023 11:05:37 AM	R101419
Nitrate+Nitrite as N	ND	1.0		mg/L	5	11/27/2023 8:23:06 PM	R101419
SM2540C MOD: TOTAL DISSOLVED SOLIDS							Analyst: MCA
Total Dissolved Solids	1650	100	*D	mg/L	1	11/28/2023 8:29:00 AM	78947
EPA 351.2: TKN							Analyst: DML
Nitrogen, Kjeldahl, Total	ND	0.50		mg/L	1	12/13/2023 6:20:28 PM	79343

Refer to the QC Summary report and sample login checklist for flagged QC data and preservation information.

Qualifiers:	*	Value exceeds Maximum Contaminant Level.	B	Analyte detected in the associated Method Blank
	D	Sample Diluted Due to Matrix	E	Above Quantitation Range/Estimated Value
	H	Holding times for preparation or analysis exceeded	J	Analyte detected below quantitation limits
	ND	Not Detected at the Reporting Limit	P	Sample pH Not In Range
	PQL	Practical Quantitative Limit	RL	Reporting Limit
	S	% Recovery outside of standard limits. If undiluted results may be estimated.		

Hall Environmental Analysis Laboratory, Inc.

Analytical Report

Lab Order 2311A13

Date Reported: 12/20/2023

CLIENT: EA Engineering

Client Sample ID: 74-02

Project: Buena Vista Dairy II

Collection Date: 11/17/2023 11:22:00 AM

Lab ID: 2311A13-002

Matrix: GROUNDWA

Received Date: 11/18/2023 11:00:00 AM

Analyses	Result	RL	Qual	Units	DF	Date Analyzed	Batch
EPA METHOD 300.0: ANIONS							Analyst: SNS
Chloride	850	50	*	mg/L	100	11/27/2023 11:31:20 AM	R101419
Nitrate+Nitrite as N	7.8	1.0		mg/L	5	11/27/2023 8:35:27 PM	R101419
SM2540C MOD: TOTAL DISSOLVED SOLIDS							Analyst: MCA
Total Dissolved Solids	3010	100	*D	mg/L	1	11/28/2023 8:29:00 AM	78947
EPA 351.2: TKN							Analyst: DML
Nitrogen, Kjeldahl, Total	0.71	0.50		mg/L	1	12/13/2023 6:27:58 PM	79343

Refer to the QC Summary report and sample login checklist for flagged QC data and preservation information.

Qualifiers:	*	Value exceeds Maximum Contaminant Level.	B	Analyte detected in the associated Method Blank
	D	Sample Diluted Due to Matrix	E	Above Quantitation Range/Estimated Value
	H	Holding times for preparation or analysis exceeded	J	Analyte detected below quantitation limits
	ND	Not Detected at the Reporting Limit	P	Sample pH Not In Range
	PQL	Practical Quantitative Limit	RL	Reporting Limit
	S	% Recovery outside of standard limits. If undiluted results may be estimated.		

Hall Environmental Analysis Laboratory, Inc.

Analytical Report

Lab Order 2311A13

Date Reported: 12/20/2023

CLIENT: EA Engineering

Client Sample ID: 74-01

Project: Buena Vista Dairy II

Collection Date: 11/17/2023 1:05:00 PM

Lab ID: 2311A13-003

Matrix: GROUNDWA

Received Date: 11/18/2023 11:00:00 AM

Analyses	Result	RL	Qual	Units	DF	Date Analyzed	Batch
EPA METHOD 300.0: ANIONS							Analyst: SNS
Chloride	820	50	*	mg/L	100	11/27/2023 11:57:04 AM	R101419
Nitrate+Nitrite as N	30	1.0	*	mg/L	5	11/27/2023 8:48:19 PM	R101419
SM2540C MOD: TOTAL DISSOLVED SOLIDS							Analyst: MCA
Total Dissolved Solids	2830	100	*D	mg/L	1	11/28/2023 8:29:00 AM	78947
EPA 351.2: TKN							Analyst: DML
Nitrogen, Kjeldahl, Total	ND	0.50		mg/L	1	12/13/2023 6:29:28 PM	79343

Refer to the QC Summary report and sample login checklist for flagged QC data and preservation information.

Qualifiers:	*	Value exceeds Maximum Contaminant Level.	B	Analyte detected in the associated Method Blank
	D	Sample Diluted Due to Matrix	E	Above Quantitation Range/Estimated Value
	H	Holding times for preparation or analysis exceeded	J	Analyte detected below quantitation limits
	ND	Not Detected at the Reporting Limit	P	Sample pH Not In Range
	PQL	Practical Quantitative Limit	RL	Reporting Limit
	S	% Recovery outside of standard limits. If undiluted results may be estimated.		

Hall Environmental Analysis Laboratory, Inc.

Analytical Report

Lab Order 2311A13

Date Reported: 12/20/2023

CLIENT: EA Engineering

Client Sample ID: 74-04

Project: Buena Vista Dairy II

Collection Date: 11/17/2023 2:56:00 PM

Lab ID: 2311A13-004

Matrix: GROUNDWA

Received Date: 11/18/2023 11:00:00 AM

Analyses	Result	RL	Qual	Units	DF	Date Analyzed	Batch
EPA METHOD 300.0: ANIONS							Analyst: SNS
Chloride	680	50	*	mg/L	100	11/27/2023 12:48:29 PM	R101419
Nitrate+Nitrite as N	10	1.0	*	mg/L	5	11/27/2023 9:01:11 PM	R101419
SM2540C MOD: TOTAL DISSOLVED SOLIDS							Analyst: MCA
Total Dissolved Solids	2270	100	*D	mg/L	1	11/28/2023 8:29:00 AM	78947
EPA 351.2: TKN							Analyst: DML
Nitrogen, Kjeldahl, Total	ND	0.50		mg/L	1	12/13/2023 6:30:58 PM	79343

Refer to the QC Summary report and sample login checklist for flagged QC data and preservation information.

Qualifiers:	*	Value exceeds Maximum Contaminant Level.	B	Analyte detected in the associated Method Blank
	D	Sample Diluted Due to Matrix	E	Above Quantitation Range/Estimated Value
	H	Holding times for preparation or analysis exceeded	J	Analyte detected below quantitation limits
	ND	Not Detected at the Reporting Limit	P	Sample pH Not In Range
	PQL	Practical Quantitative Limit	RL	Reporting Limit
	S	% Recovery outside of standard limits. If undiluted results may be estimated.		

Hall Environmental Analysis Laboratory, Inc.

Analytical Report

Lab Order 2311A13

Date Reported: 12/20/2023

CLIENT: EA Engineering

Client Sample ID: 74-05

Project: Buena Vista Dairy II

Collection Date: 11/17/2023 4:45:00 PM

Lab ID: 2311A13-005

Matrix: GROUNDWA

Received Date: 11/18/2023 11:00:00 AM

Analyses	Result	RL	Qual	Units	DF	Date Analyzed	Batch
EPA METHOD 300.0: ANIONS							Analyst: SNS
Chloride	630	50	*	mg/L	100	11/27/2023 1:39:57 PM	R101419
Nitrate+Nitrite as N	16	1.0	*	mg/L	5	11/27/2023 9:14:03 PM	R101419
SM2540C MOD: TOTAL DISSOLVED SOLIDS							Analyst: MCA
Total Dissolved Solids	2200	100	*D	mg/L	1	11/28/2023 8:29:00 AM	78947
EPA 351.2: TKN							Analyst: DML
Nitrogen, Kjeldahl, Total	ND	0.50		mg/L	1	12/13/2023 6:32:28 PM	79343

Refer to the QC Summary report and sample login checklist for flagged QC data and preservation information.

Qualifiers:	*	Value exceeds Maximum Contaminant Level.	B	Analyte detected in the associated Method Blank
	D	Sample Diluted Due to Matrix	E	Above Quantitation Range/Estimated Value
	H	Holding times for preparation or analysis exceeded	J	Analyte detected below quantitation limits
	ND	Not Detected at the Reporting Limit	P	Sample pH Not In Range
	PQL	Practical Quantitative Limit	RL	Reporting Limit
	S	% Recovery outside of standard limits. If undiluted results may be estimated.		

QC SUMMARY REPORT

Hall Environmental Analysis Laboratory, Inc.

WO#: 2311A13

20-Dec-23

Client: EA Engineering
Project: Buena Vista Dairy II

Sample ID: MB	SampType: MBLK	TestCode: EPA Method 300.0: Anions								
Client ID: PBW	Batch ID: R101419	RunNo: 101419								
Prep Date:	Analysis Date: 11/27/2023	SeqNo: 3731493	Units: mg/L							
Analyte	Result	PQL	SPK value	SPK Ref Val	%REC	LowLimit	HighLimit	%RPD	RPDLimit	Qual
Chloride	ND	0.50								
Nitrate+Nitrite as N	ND	0.20								

Sample ID: LCS	SampType: LCS	TestCode: EPA Method 300.0: Anions								
Client ID: LCSW	Batch ID: R101419	RunNo: 101419								
Prep Date:	Analysis Date: 11/27/2023	SeqNo: 3731494	Units: mg/L							
Analyte	Result	PQL	SPK value	SPK Ref Val	%REC	LowLimit	HighLimit	%RPD	RPDLimit	Qual
Chloride	4.9	0.50	5.000	0	97.5	90	110			
Nitrate+Nitrite as N	3.5	0.20	3.500	0	101	90	110			

Qualifiers:

- | | |
|---|---|
| * Value exceeds Maximum Contaminant Level. | B Analyte detected in the associated Method Blank |
| D Sample Diluted Due to Matrix | E Above Quantitation Range/Estimated Value |
| H Holding times for preparation or analysis exceeded | J Analyte detected below quantitation limits |
| ND Not Detected at the Reporting Limit | P Sample pH Not In Range |
| PQL Practical Quantitative Limit | RL Reporting Limit |
| S % Recovery outside of standard limits. If undiluted results may be estimated. | |

QC SUMMARY REPORT

Hall Environmental Analysis Laboratory, Inc.

WO#: 2311A13

20-Dec-23

Client: EA Engineering
Project: Buena Vista Dairy II

Sample ID: MB-78947	SampType: MBLK	TestCode: SM2540C MOD: Total Dissolved Solids								
Client ID: PBW	Batch ID: 78947	RunNo: 101428								
Prep Date: 11/22/2023	Analysis Date: 11/28/2023	SeqNo: 3732122	Units: mg/L							
Analyte	Result	PQL	SPK value	SPK Ref Val	%REC	LowLimit	HighLimit	%RPD	RPDLimit	Qual
Total Dissolved Solids	ND	50.0								

Sample ID: LCS-78947	SampType: LCS	TestCode: SM2540C MOD: Total Dissolved Solids								
Client ID: LCSW	Batch ID: 78947	RunNo: 101428								
Prep Date: 11/22/2023	Analysis Date: 11/28/2023	SeqNo: 3732123	Units: mg/L							
Analyte	Result	PQL	SPK value	SPK Ref Val	%REC	LowLimit	HighLimit	%RPD	RPDLimit	Qual
Total Dissolved Solids	1060	50.0	1000	0	106	80	120			

Qualifiers:

- * Value exceeds Maximum Contaminant Level.
- D Sample Diluted Due to Matrix
- H Holding times for preparation or analysis exceeded
- ND Not Detected at the Reporting Limit
- PQL Practical Quantitative Limit
- S % Recovery outside of standard limits. If undiluted results may be estimated.
- B Analyte detected in the associated Method Blank
- E Above Quantitation Range/Estimated Value
- J Analyte detected below quantitation limits
- P Sample pH Not In Range
- RL Reporting Limit

QC SUMMARY REPORT

Hall Environmental Analysis Laboratory, Inc.

WO#: 2311A13

20-Dec-23

Client: EA Engineering
Project: Buena Vista Dairy II

Sample ID: MB-79343	SampType: MBLK	TestCode: EPA 351.2: TKN								
Client ID: PBW	Batch ID: 79343	RunNo: 101810								
Prep Date: 12/13/2023	Analysis Date: 12/13/2023	SeqNo: 3753176	Units: mg/L							
Analyte	Result	PQL	SPK value	SPK Ref Val	%REC	LowLimit	HighLimit	%RPD	RPDLimit	Qual
Nitrogen, Kjeldahl, Total	ND	0.50								

Sample ID: LCSLL-79343	SampType: LCSLL	TestCode: EPA 351.2: TKN								
Client ID: BatchQC	Batch ID: 79343	RunNo: 101810								
Prep Date: 12/13/2023	Analysis Date: 12/13/2023	SeqNo: 3753177	Units: mg/L							
Analyte	Result	PQL	SPK value	SPK Ref Val	%REC	LowLimit	HighLimit	%RPD	RPDLimit	Qual
Nitrogen, Kjeldahl, Total	0.50	0.50	0.5000	0	101	50	150			

Sample ID: LCS-79343	SampType: LCS	TestCode: EPA 351.2: TKN								
Client ID: LCSW	Batch ID: 79343	RunNo: 101810								
Prep Date: 12/13/2023	Analysis Date: 12/13/2023	SeqNo: 3753178	Units: mg/L							
Analyte	Result	PQL	SPK value	SPK Ref Val	%REC	LowLimit	HighLimit	%RPD	RPDLimit	Qual
Nitrogen, Kjeldahl, Total	9.7	0.50	10.00	0	96.9	90	110			

Sample ID: 2311A13-001AMS	SampType: MS	TestCode: EPA 351.2: TKN								
Client ID: 74-03	Batch ID: 79343	RunNo: 101810								
Prep Date: 12/13/2023	Analysis Date: 12/13/2023	SeqNo: 3753180	Units: mg/L							
Analyte	Result	PQL	SPK value	SPK Ref Val	%REC	LowLimit	HighLimit	%RPD	RPDLimit	Qual
Nitrogen, Kjeldahl, Total	9.9	0.50	10.00	0	98.6	90	110			

Sample ID: 2311A13-001AMSD	SampType: MSD	TestCode: EPA 351.2: TKN								
Client ID: 74-03	Batch ID: 79343	RunNo: 101810								
Prep Date: 12/13/2023	Analysis Date: 12/13/2023	SeqNo: 3753181	Units: mg/L							
Analyte	Result	PQL	SPK value	SPK Ref Val	%REC	LowLimit	HighLimit	%RPD	RPDLimit	Qual
Nitrogen, Kjeldahl, Total	10	0.50	10.00	0	99.8	90	110	1.30	0	

Qualifiers:

- * Value exceeds Maximum Contaminant Level.
- D Sample Diluted Due to Matrix
- H Holding times for preparation or analysis exceeded
- ND Not Detected at the Reporting Limit
- PQL Practical Quantitative Limit
- S % Recovery outside of standard limits. If undiluted results may be estimated.
- B Analyte detected in the associated Method Blank
- E Above Quantitation Range/Estimated Value
- J Analyte detected below quantitation limits
- P Sample pH Not In Range
- RL Reporting Limit

Sample Log-In Check List

Client Name: **EA Engineering** Work Order Number: **2311A13** RcptNo: **1**

Received By: **Tracy Casarrubias** 11/18/2023 11:00:00 AM

Completed By: **Tracy Casarrubias** 11/19/2023 8:45:14 AM

Reviewed By: *JG 11-20-23*

Chain of Custody

1. Is Chain of Custody complete? Yes No Not Present
2. How was the sample delivered? FedEx

Log In

3. Was an attempt made to cool the samples? Yes No NA
4. Were all samples received at a temperature of >0° C to 6.0°C Yes No NA
5. Sample(s) in proper container(s)? Yes No
6. Sufficient sample volume for indicated test(s)? Yes No
7. Are samples (except VOA and ONG) properly preserved? Yes No
8. Was preservative added to bottles? Yes No NA
9. Received at least 1 vial with headspace <1/4" for AQ VOA? Yes No NA
10. Were any sample containers received broken? Yes No
11. Does paperwork match bottle labels? Yes No
(Note discrepancies on chain of custody)
12. Are matrices correctly identified on Chain of Custody? Yes No
13. Is it clear what analyses were requested? Yes No
14. Were all holding times able to be met? Yes No
(If no, notify customer for authorization.)

of preserved bottles checked for pH: *5*
(*5* or >12 unless noted)
Adjusted? *NO*
Checked by: *JG 11/20/23*

Special Handling (if applicable)

15. Was client notified of all discrepancies with this order? Yes No NA

Person Notified: _____ Date: _____
 By Whom: _____ Via: eMail Phone Fax In Person
 Regarding: _____
 Client Instructions: _____

16. Additional remarks:

17. Cooler Information

Cooler No	Temp °C	Condition	Seal Intact	Seal No	Seal Date	Signed By
1	0.8	Good	Yes	Morty		

December 20, 2023

Regina Mullen
EA Engineering
320 Gold Ave SW Suite 1210
Albuquerque, NM 87102
TEL:
FAX:

RE: Big Sky Dairy

OrderNo.: 2311A99

Dear Regina Mullen:

Eurofins Environment Testing South Central, LLC received 3 sample(s) on 11/21/2023 for the analyses presented in the following report.

These were analyzed according to EPA procedures or equivalent. To access our accredited tests please go to www.hallenvironmental.com or the state specific web sites. In order to properly interpret your results, it is imperative that you review this report in its entirety. See the sample checklist and/or the Chain of Custody for information regarding the sample receipt temperature and preservation. Data qualifiers or a narrative will be provided if the sample analysis or analytical quality control parameters require a flag. When necessary, data qualifiers are provided on both the sample analysis report and the QC summary report, both sections should be reviewed. All samples are reported, as received, unless otherwise indicated. Lab measurement of analytes considered field parameters that require analysis within 15 minutes of sampling such as pH and residual chlorine are qualified as being analyzed outside of the recommended holding time.

Please do not hesitate to contact Eurofins Albuquerque for any additional information or clarifications.

ADHS Cert #AZ0682 -- NMED-DWB Cert #NM9425 -- NMED-Micro Cert #NM0901

Sincerely,



Andy Freeman
Laboratory Manager
4901 Hawkins NE
Albuquerque, NM 87109

Hall Environmental Analysis Laboratory, Inc.

Analytical Report

Lab Order 2311A99

Date Reported: 12/20/2023

CLIENT: EA Engineering

Client Sample ID: 833-06

Project: Big Sky Dairy

Collection Date: 11/20/2023 11:35:00 AM

Lab ID: 2311A99-001

Matrix: GROUNDWA

Received Date: 11/21/2023 8:40:00 AM

Analyses	Result	RL	Qual	Units	DF	Date Analyzed	Batch
EPA METHOD 300.0: ANIONS							Analyst: JMT
Chloride	770	50	*	mg/L	100	11/21/2023 8:49:20 PM	R101364
Nitrogen, Nitrite (As N)	ND	1.0		mg/L	10	11/21/2023 8:35:26 PM	R101364
Nitrogen, Nitrate (As N)	15	1.0	*	mg/L	10	11/21/2023 8:35:26 PM	R101364
Sulfate	500	5.0	*	mg/L	10	11/21/2023 8:35:26 PM	R101364
SM2540C MOD: TOTAL DISSOLVED SOLIDS							Analyst: MCA
Total Dissolved Solids	2350	100	*D	mg/L	1	11/28/2023 8:25:00 AM	78962
EPA 351.2: TKN							Analyst: DML
Nitrogen, Kjeldahl, Total	ND	0.50		mg/L	1	12/13/2023 7:17:31 PM	79344

Refer to the QC Summary report and sample login checklist for flagged QC data and preservation information.

Qualifiers:	*	Value exceeds Maximum Contaminant Level.	B	Analyte detected in the associated Method Blank
	D	Sample Diluted Due to Matrix	E	Above Quantitation Range/Estimated Value
	H	Holding times for preparation or analysis exceeded	J	Analyte detected below quantitation limits
	ND	Not Detected at the Reporting Limit	P	Sample pH Not In Range
	PQL	Practical Quantitative Limit	RL	Reporting Limit
	S	% Recovery outside of standard limits. If undiluted results may be estimated.		

Hall Environmental Analysis Laboratory, Inc.

Analytical Report

Lab Order 2311A99

Date Reported: 12/20/2023

CLIENT: EA Engineering

Client Sample ID: 833-04

Project: Big Sky Dairy

Collection Date: 11/20/2023 1:40:00 PM

Lab ID: 2311A99-002

Matrix: GROUNDWA

Received Date: 11/21/2023 8:40:00 AM

Analyses	Result	RL	Qual	Units	DF	Date Analyzed	Batch
EPA METHOD 300.0: ANIONS							Analyst: JMT
Chloride	930	50	*	mg/L	100	11/21/2023 9:15:01 PM	R101364
Nitrogen, Nitrite (As N)	ND	1.0		mg/L	10	11/21/2023 9:02:09 PM	R101364
Nitrogen, Nitrate (As N)	35	1.0	*	mg/L	10	11/21/2023 9:02:09 PM	R101364
Sulfate	500	50	*	mg/L	100	11/21/2023 9:15:01 PM	R101364
SM2540C MOD: TOTAL DISSOLVED SOLIDS							Analyst: KS
Total Dissolved Solids	3060	50.0	*	mg/L	1	11/28/2023 3:28:00 PM	78972
EPA 351.2: TKN							Analyst: DML
Nitrogen, Kjeldahl, Total	ND	0.50		mg/L	1	12/13/2023 7:22:02 PM	79344

Refer to the QC Summary report and sample login checklist for flagged QC data and preservation information.

Qualifiers:	*	Value exceeds Maximum Contaminant Level.	B	Analyte detected in the associated Method Blank
	D	Sample Diluted Due to Matrix	E	Above Quantitation Range/Estimated Value
	H	Holding times for preparation or analysis exceeded	J	Analyte detected below quantitation limits
	ND	Not Detected at the Reporting Limit	P	Sample pH Not In Range
	PQL	Practical Quantitative Limit	RL	Reporting Limit
	S	% Recovery outside of standard limits. If undiluted results may be estimated.		

Hall Environmental Analysis Laboratory, Inc.

Analytical Report

Lab Order 2311A99

Date Reported: 12/20/2023

CLIENT: EA Engineering

Client Sample ID: 833-02

Project: Big Sky Dairy

Collection Date: 11/20/2023 4:51:00 PM

Lab ID: 2311A99-003

Matrix: GROUNDWA

Received Date: 11/21/2023 8:40:00 AM

Analyses	Result	RL	Qual	Units	DF	Date Analyzed	Batch
EPA METHOD 300.0: ANIONS							Analyst: JMT
Chloride	1400	50	*	mg/L	100	11/21/2023 9:40:46 PM	R101364
Nitrogen, Nitrite (As N)	ND	1.0		mg/L	10	11/21/2023 9:27:55 PM	R101364
Nitrogen, Nitrate (As N)	35	1.0	*	mg/L	10	11/21/2023 9:27:55 PM	R101364
Sulfate	700	50	*	mg/L	100	11/21/2023 9:40:46 PM	R101364
SM2540C MOD: TOTAL DISSOLVED SOLIDS							Analyst: KS
Total Dissolved Solids	4080	50.0	*	mg/L	1	11/28/2023 3:28:00 PM	78972
EPA 351.2: TKN							Analyst: DML
Nitrogen, Kjeldahl, Total	ND	0.50		mg/L	1	12/13/2023 7:23:32 PM	79344

Refer to the QC Summary report and sample login checklist for flagged QC data and preservation information.

Qualifiers:	*	Value exceeds Maximum Contaminant Level.	B	Analyte detected in the associated Method Blank
	D	Sample Diluted Due to Matrix	E	Above Quantitation Range/Estimated Value
	H	Holding times for preparation or analysis exceeded	J	Analyte detected below quantitation limits
	ND	Not Detected at the Reporting Limit	P	Sample pH Not In Range
	PQL	Practical Quantitative Limit	RL	Reporting Limit
	S	% Recovery outside of standard limits. If undiluted results may be estimated.		

QC SUMMARY REPORT

Hall Environmental Analysis Laboratory, Inc.

WO#: 2311A99

20-Dec-23

Client: EA Engineering
Project: Big Sky Dairy

Sample ID: MB	SampType: mblk	TestCode: EPA Method 300.0: Anions								
Client ID: PBW	Batch ID: R101364	RunNo: 101364								
Prep Date:	Analysis Date: 11/21/2023	SeqNo: 3728885			Units: mg/L					
Analyte	Result	PQL	SPK value	SPK Ref Val	%REC	LowLimit	HighLimit	%RPD	RPDLimit	Qual
Chloride	ND	0.50								
Nitrogen, Nitrite (As N)	ND	0.10								
Nitrogen, Nitrate (As N)	ND	0.10								
Sulfate	ND	0.50								

Sample ID: LCS	SampType: lcs	TestCode: EPA Method 300.0: Anions								
Client ID: LCSW	Batch ID: R101364	RunNo: 101364								
Prep Date:	Analysis Date: 11/21/2023	SeqNo: 3728887			Units: mg/L					
Analyte	Result	PQL	SPK value	SPK Ref Val	%REC	LowLimit	HighLimit	%RPD	RPDLimit	Qual
Chloride	4.7	0.50	5.000	0	94.8	90	110			
Nitrogen, Nitrite (As N)	0.97	0.10	1.000	0	96.9	90	110			
Nitrogen, Nitrate (As N)	2.5	0.10	2.500	0	98.9	90	110			
Sulfate	9.5	0.50	10.00	0	95.4	90	110			

Qualifiers:

- * Value exceeds Maximum Contaminant Level.
- D Sample Diluted Due to Matrix
- H Holding times for preparation or analysis exceeded
- ND Not Detected at the Reporting Limit
- PQL Practical Quantitative Limit
- S % Recovery outside of standard limits. If undiluted results may be estimated.
- B Analyte detected in the associated Method Blank
- E Above Quantitation Range/Estimated Value
- J Analyte detected below quantitation limits
- P Sample pH Not In Range
- RL Reporting Limit

QC SUMMARY REPORT

Hall Environmental Analysis Laboratory, Inc.

WO#: 2311A99

20-Dec-23

Client: EA Engineering
Project: Big Sky Dairy

Sample ID: MB-78962	SampType: MBLK		TestCode: SM2540C MOD: Total Dissolved Solids							
Client ID: PBW	Batch ID: 78962		RunNo: 101431							
Prep Date: 11/22/2023	Analysis Date: 11/28/2023		SeqNo: 3732177		Units: mg/L					
Analyte	Result	PQL	SPK value	SPK Ref Val	%REC	LowLimit	HighLimit	%RPD	RPDLimit	Qual
Total Dissolved Solids	ND	50.0								

Sample ID: LCS-78962	SampType: LCS		TestCode: SM2540C MOD: Total Dissolved Solids							
Client ID: LCSW	Batch ID: 78962		RunNo: 101431							
Prep Date: 11/22/2023	Analysis Date: 11/28/2023		SeqNo: 3732178		Units: mg/L					
Analyte	Result	PQL	SPK value	SPK Ref Val	%REC	LowLimit	HighLimit	%RPD	RPDLimit	Qual
Total Dissolved Solids	1020	50.0	1000	0	102	80	120			

Sample ID: MB-78972	SampType: MBLK		TestCode: SM2540C MOD: Total Dissolved Solids							
Client ID: PBW	Batch ID: 78972		RunNo: 101447							
Prep Date: 11/27/2023	Analysis Date: 11/28/2023		SeqNo: 3732528		Units: mg/L					
Analyte	Result	PQL	SPK value	SPK Ref Val	%REC	LowLimit	HighLimit	%RPD	RPDLimit	Qual
Total Dissolved Solids	ND	50.0								

Sample ID: LCS-78972	SampType: LCS		TestCode: SM2540C MOD: Total Dissolved Solids							
Client ID: LCSW	Batch ID: 78972		RunNo: 101447							
Prep Date: 11/27/2023	Analysis Date: 11/28/2023		SeqNo: 3732529		Units: mg/L					
Analyte	Result	PQL	SPK value	SPK Ref Val	%REC	LowLimit	HighLimit	%RPD	RPDLimit	Qual
Total Dissolved Solids	1040	50.0	1000	0	104	80	120			

Qualifiers:

- * Value exceeds Maximum Contaminant Level.
- D Sample Diluted Due to Matrix
- H Holding times for preparation or analysis exceeded
- ND Not Detected at the Reporting Limit
- PQL Practical Quantitative Limit
- S % Recovery outside of standard limits. If undiluted results may be estimated.
- B Analyte detected in the associated Method Blank
- E Above Quantitation Range/Estimated Value
- J Analyte detected below quantitation limits
- P Sample pH Not In Range
- RL Reporting Limit

QC SUMMARY REPORT

Hall Environmental Analysis Laboratory, Inc.

WO#: 2311A99

20-Dec-23

Client: EA Engineering
Project: Big Sky Dairy

Sample ID: MB-79344	SampType: MBLK	TestCode: EPA 351.2: TKN								
Client ID: PBW	Batch ID: 79344	RunNo: 101810								
Prep Date: 12/13/2023	Analysis Date: 12/13/2023	SeqNo: 3753209	Units: mg/L							
Analyte	Result	PQL	SPK value	SPK Ref Val	%REC	LowLimit	HighLimit	%RPD	RPDLimit	Qual
Nitrogen, Kjeldahl, Total	ND	0.50								

Sample ID: LCSLL-79344	SampType: LCSLL	TestCode: EPA 351.2: TKN								
Client ID: BatchQC	Batch ID: 79344	RunNo: 101810								
Prep Date: 12/13/2023	Analysis Date: 12/13/2023	SeqNo: 3753210	Units: mg/L							
Analyte	Result	PQL	SPK value	SPK Ref Val	%REC	LowLimit	HighLimit	%RPD	RPDLimit	Qual
Nitrogen, Kjeldahl, Total	0.51	0.50	0.5000	0	103	50	150			

Sample ID: LCS-79344	SampType: LCS	TestCode: EPA 351.2: TKN								
Client ID: LCSW	Batch ID: 79344	RunNo: 101810								
Prep Date: 12/13/2023	Analysis Date: 12/13/2023	SeqNo: 3753211	Units: mg/L							
Analyte	Result	PQL	SPK value	SPK Ref Val	%REC	LowLimit	HighLimit	%RPD	RPDLimit	Qual
Nitrogen, Kjeldahl, Total	9.7	0.50	10.00	0	97.1	90	110			

Qualifiers:

- * Value exceeds Maximum Contaminant Level.
- D Sample Diluted Due to Matrix
- H Holding times for preparation or analysis exceeded
- ND Not Detected at the Reporting Limit
- PQL Practical Quantitative Limit
- S % Recovery outside of standard limits. If undiluted results may be estimated.
- B Analyte detected in the associated Method Blank
- E Above Quantitation Range/Estimated Value
- J Analyte detected below quantitation limits
- P Sample pH Not In Range
- RL Reporting Limit

Sample Log-In Check List

Client Name: **EA Engineering** Work Order Number: **2311A99** RcptNo: **1**

Received By: **Steve McQuiston** 11/21/2023 8:40:00 AM *Steve McQuiston*

Completed By: **Cheyenne Cason** 11/21/2023 11:02:16 AM *Cheyenne Cason*

Reviewed By: *JM 11/21/23*

Chain of Custody

1. Is Chain of Custody complete? Yes No Not Present
2. How was the sample delivered? *Client FedEX 11/21/23*

Log In

3. Was an attempt made to cool the samples? Yes No NA
4. Were all samples received at a temperature of >0° C to 6.0°C Yes No NA
5. Sample(s) in proper container(s)? Yes No
6. Sufficient sample volume for indicated test(s)? Yes No
7. Are samples (except VOA and ONG) properly preserved? Yes No
8. Was preservative added to bottles? Yes No NA
9. Received at least 1 vial with headspace <1/4" for AQ VOA? Yes No NA
10. Were any sample containers received broken? Yes No
11. Does paperwork match bottle labels? Yes No
(Note discrepancies on chain of custody)
12. Are matrices correctly identified on Chain of Custody? Yes No
13. Is it clear what analyses were requested? Yes No
14. Were all holding times able to be met? Yes No
(If no, notify customer for authorization.)

of preserved bottles checked for pH: *3*
(*<2 or >12 unless noted*)

Adjusted? *NO*

Checked by: *SEM 11/21/23*

Special Handling (if applicable)

15. Was client notified of all discrepancies with this order? Yes No NA

Person Notified: _____ Date: _____

By Whom: _____ Via: eMail Phone Fax In Person

Regarding: _____

Client Instructions: _____

16. Additional remarks:

17. Cooler Information

Cooler No	Temp °C	Condition	Seal Intact	Seal No	Seal Date	Signed By
1	1.6	Good	Not Present	Yogi		

December 28, 2023

Regina Mullen
EA Engineering
320 Gold Ave SW Suite 1210
Albuquerque, NM 87102
TEL:
FAX:

RE: Big Sky Dairy

OrderNo.: 2311B70

Dear Regina Mullen:

Eurofins Environment Testing South Central, LLC received 3 sample(s) on 11/22/2023 for the analyses presented in the following report.

These were analyzed according to EPA procedures or equivalent. To access our accredited tests please go to www.hallenvironmental.com or the state specific web sites. In order to properly interpret your results, it is imperative that you review this report in its entirety. See the sample checklist and/or the Chain of Custody for information regarding the sample receipt temperature and preservation. Data qualifiers or a narrative will be provided if the sample analysis or analytical quality control parameters require a flag. When necessary, data qualifiers are provided on both the sample analysis report and the QC summary report, both sections should be reviewed. All samples are reported, as received, unless otherwise indicated. Lab measurement of analytes considered field parameters that require analysis within 15 minutes of sampling such as pH and residual chlorine are qualified as being analyzed outside of the recommended holding time.

Please do not hesitate to contact Eurofins Albuquerque for any additional information or clarifications.

ADHS Cert #AZ0682 -- NMED-DWB Cert #NM9425 -- NMED-Micro Cert #NM0901

Sincerely,



Andy Freeman
Laboratory Manager
4901 Hawkins NE
Albuquerque, NM 87109

Hall Environmental Analysis Laboratory, Inc.

Analytical Report

Lab Order 2311B70

Date Reported: 12/28/2023

CLIENT: EA Engineering

Client Sample ID: 833-08

Project: Big Sky Dairy

Collection Date: 11/21/2023 10:37:00 AM

Lab ID: 2311B70-001

Matrix: GROUNDWA

Received Date: 11/22/2023 9:40:00 AM

Analyses	Result	RL	Qual	Units	DF	Date Analyzed	Batch
EPA METHOD 300.0: ANIONS							Analyst: RBC
Chloride	1100	50	*	mg/L	100	11/23/2023 5:24:03 AM	R101389
Nitrogen, Nitrite (As N)	ND	1.0		mg/L	10	11/23/2023 5:11:38 AM	R101389
Nitrogen, Nitrate (As N)	67	1.0	*	mg/L	10	11/23/2023 5:11:38 AM	R101389
Sulfate	440	50	*	mg/L	100	11/23/2023 5:24:03 AM	R101389
SM2540C MOD: TOTAL DISSOLVED SOLIDS							Analyst: KS
Total Dissolved Solids	3460	50.0	*	mg/L	1	11/29/2023 3:56:00 PM	79014
EPA 351.2: TKN							Analyst: DML
Nitrogen, Kjeldahl, Total	ND	0.50		mg/L	1	12/14/2023 5:06:08 PM	79377

Refer to the QC Summary report and sample login checklist for flagged QC data and preservation information.

Qualifiers:	*	Value exceeds Maximum Contaminant Level.	B	Analyte detected in the associated Method Blank
	D	Sample Diluted Due to Matrix	E	Above Quantitation Range/Estimated Value
	H	Holding times for preparation or analysis exceeded	J	Analyte detected below quantitation limits
	ND	Not Detected at the Reporting Limit	P	Sample pH Not In Range
	PQL	Practical Quantitative Limit	RL	Reporting Limit
	S	% Recovery outside of standard limits. If undiluted results may be estimated.		

Hall Environmental Analysis Laboratory, Inc.

Analytical Report

Lab Order 2311B70

Date Reported: 12/28/2023

CLIENT: EA Engineering

Client Sample ID: 833-05

Project: Big Sky Dairy

Collection Date: 11/21/2023 12:35:00 PM

Lab ID: 2311B70-002

Matrix: GROUNDWA

Received Date: 11/22/2023 9:40:00 AM

Analyses	Result	RL	Qual	Units	DF	Date Analyzed	Batch
EPA METHOD 300.0: ANIONS							Analyst: RBC
Chloride	1000	50	*	mg/L	100	11/23/2023 5:48:52 AM	R101389
Nitrogen, Nitrite (As N)	ND	1.0		mg/L	10	11/23/2023 5:36:28 AM	R101389
Nitrogen, Nitrate (As N)	21	1.0	*	mg/L	10	11/23/2023 5:36:28 AM	R101389
Sulfate	490	5.0	*	mg/L	10	11/23/2023 5:36:28 AM	R101389
SM2540C MOD: TOTAL DISSOLVED SOLIDS							Analyst: KS
Total Dissolved Solids	3000	100	*D	mg/L	1	11/29/2023 3:56:00 PM	79014
EPA 351.2: TKN							Analyst: DML
Nitrogen, Kjeldahl, Total	ND	0.50		mg/L	1	12/14/2023 5:10:39 PM	79377

Refer to the QC Summary report and sample login checklist for flagged QC data and preservation information.

Qualifiers:	*	Value exceeds Maximum Contaminant Level.	B	Analyte detected in the associated Method Blank
	D	Sample Diluted Due to Matrix	E	Above Quantitation Range/Estimated Value
	H	Holding times for preparation or analysis exceeded	J	Analyte detected below quantitation limits
	ND	Not Detected at the Reporting Limit	P	Sample pH Not In Range
	PQL	Practical Quantitative Limit	RL	Reporting Limit
	S	% Recovery outside of standard limits. If undiluted results may be estimated.		

Hall Environmental Analysis Laboratory, Inc.

Analytical Report

Lab Order 2311B70

Date Reported: 12/28/2023

CLIENT: EA Engineering

Client Sample ID: 833-07

Project: Big Sky Dairy

Collection Date: 11/21/2023 4:10:00 PM

Lab ID: 2311B70-003

Matrix: GROUNDWA

Received Date: 11/22/2023 9:40:00 AM

Analyses	Result	RL	Qual	Units	DF	Date Analyzed	Batch
EPA METHOD 300.0: ANIONS							Analyst: RBC
Chloride	1300	50	*	mg/L	100	11/23/2023 6:13:41 AM	R101389
Nitrogen, Nitrite (As N)	ND	1.0		mg/L	10	11/23/2023 6:01:16 AM	R101389
Nitrogen, Nitrate (As N)	77	10	*	mg/L	100	11/23/2023 6:13:41 AM	R101389
Sulfate	670	50	*	mg/L	100	11/23/2023 6:13:41 AM	R101389
SM2540C MOD: TOTAL DISSOLVED SOLIDS							Analyst: KS
Total Dissolved Solids	4020	100	*D	mg/L	1	11/29/2023 3:56:00 PM	79014
EPA 351.2: TKN							Analyst: DML
Nitrogen, Kjeldahl, Total	ND	0.50		mg/L	1	12/14/2023 5:12:09 PM	79377

Refer to the QC Summary report and sample login checklist for flagged QC data and preservation information.

Qualifiers:	*	Value exceeds Maximum Contaminant Level.	B	Analyte detected in the associated Method Blank
	D	Sample Diluted Due to Matrix	E	Above Quantitation Range/Estimated Value
	H	Holding times for preparation or analysis exceeded	J	Analyte detected below quantitation limits
	ND	Not Detected at the Reporting Limit	P	Sample pH Not In Range
	PQL	Practical Quantitative Limit	RL	Reporting Limit
	S	% Recovery outside of standard limits. If undiluted results may be estimated.		

QC SUMMARY REPORT

Hall Environmental Analysis Laboratory, Inc.

WO#: 2311B70

28-Dec-23

Client: EA Engineering
Project: Big Sky Dairy

Sample ID: MB	SampType: MBLK	TestCode: EPA Method 300.0: Anions								
Client ID: PBW	Batch ID: R101389	RunNo: 101389								
Prep Date:	Analysis Date: 11/22/2023	SeqNo: 3730227			Units: mg/L					
Analyte	Result	PQL	SPK value	SPK Ref Val	%REC	LowLimit	HighLimit	%RPD	RPDLimit	Qual
Chloride	ND	0.50								
Nitrogen, Nitrite (As N)	ND	0.10								
Nitrogen, Nitrate (As N)	ND	0.10								
Sulfate	ND	0.50								

Sample ID: LCS	SampType: LCS	TestCode: EPA Method 300.0: Anions								
Client ID: LCSW	Batch ID: R101389	RunNo: 101389								
Prep Date:	Analysis Date: 11/22/2023	SeqNo: 3730228			Units: mg/L					
Analyte	Result	PQL	SPK value	SPK Ref Val	%REC	LowLimit	HighLimit	%RPD	RPDLimit	Qual
Chloride	4.8	0.50	5.000	0	95.6	90	110			
Nitrogen, Nitrite (As N)	0.98	0.10	1.000	0	98.0	90	110			
Nitrogen, Nitrate (As N)	2.5	0.10	2.500	0	99.4	90	110			
Sulfate	9.6	0.50	10.00	0	96.4	90	110			

Qualifiers:

- * Value exceeds Maximum Contaminant Level.
- D Sample Diluted Due to Matrix
- H Holding times for preparation or analysis exceeded
- ND Not Detected at the Reporting Limit
- PQL Practical Quantitative Limit
- S % Recovery outside of standard limits. If undiluted results may be estimated.
- B Analyte detected in the associated Method Blank
- E Above Quantitation Range/Estimated Value
- J Analyte detected below quantitation limits
- P Sample pH Not In Range
- RL Reporting Limit

QC SUMMARY REPORT

Hall Environmental Analysis Laboratory, Inc.

WO#: 2311B70

28-Dec-23

Client: EA Engineering
Project: Big Sky Dairy

Sample ID: MB-79014	SampType: MBLK	TestCode: SM2540C MOD: Total Dissolved Solids								
Client ID: PBW	Batch ID: 79014	RunNo: 101481								
Prep Date: 11/28/2023	Analysis Date: 11/29/2023	SeqNo: 3735071	Units: mg/L							
Analyte	Result	PQL	SPK value	SPK Ref Val	%REC	LowLimit	HighLimit	%RPD	RPDLimit	Qual
Total Dissolved Solids	ND	50.0								

Sample ID: LCS-79014	SampType: LCS	TestCode: SM2540C MOD: Total Dissolved Solids								
Client ID: LCSW	Batch ID: 79014	RunNo: 101481								
Prep Date: 11/28/2023	Analysis Date: 11/29/2023	SeqNo: 3735072	Units: mg/L							
Analyte	Result	PQL	SPK value	SPK Ref Val	%REC	LowLimit	HighLimit	%RPD	RPDLimit	Qual
Total Dissolved Solids	1070	50.0	1000	0	107	80	120			

Sample ID: 2311B70-001ADUP	SampType: DUP	TestCode: SM2540C MOD: Total Dissolved Solids								
Client ID: 833-08	Batch ID: 79014	RunNo: 101481								
Prep Date: 11/28/2023	Analysis Date: 11/29/2023	SeqNo: 3735074	Units: mg/L							
Analyte	Result	PQL	SPK value	SPK Ref Val	%REC	LowLimit	HighLimit	%RPD	RPDLimit	Qual
Total Dissolved Solids	3460	50.0						0.144	10	*

Qualifiers:

- * Value exceeds Maximum Contaminant Level.
- D Sample Diluted Due to Matrix
- H Holding times for preparation or analysis exceeded
- ND Not Detected at the Reporting Limit
- PQL Practical Quantitative Limit
- S % Recovery outside of standard limits. If undiluted results may be estimated.
- B Analyte detected in the associated Method Blank
- E Above Quantitation Range/Estimated Value
- J Analyte detected below quantitation limits
- P Sample pH Not In Range
- RL Reporting Limit

QC SUMMARY REPORT

Hall Environmental Analysis Laboratory, Inc.

WO#: 2311B70

28-Dec-23

Client: EA Engineering
Project: Big Sky Dairy

Sample ID: MB-79377	SampType: MBLK	TestCode: EPA 351.2: TKN								
Client ID: PBW	Batch ID: 79377	RunNo: 101842								
Prep Date: 12/14/2023	Analysis Date: 12/14/2023	SeqNo: 3760874	Units: mg/L							
Analyte	Result	PQL	SPK value	SPK Ref Val	%REC	LowLimit	HighLimit	%RPD	RPDLimit	Qual
Nitrogen, Kjeldahl, Total	ND	0.50								

Sample ID: LCSLL-79377	SampType: LCSLL	TestCode: EPA 351.2: TKN								
Client ID: BatchQC	Batch ID: 79377	RunNo: 101842								
Prep Date: 12/14/2023	Analysis Date: 12/14/2023	SeqNo: 3760875	Units: mg/L							
Analyte	Result	PQL	SPK value	SPK Ref Val	%REC	LowLimit	HighLimit	%RPD	RPDLimit	Qual
Nitrogen, Kjeldahl, Total	0.46	0	0.5000	0	92.9	50	150			

Sample ID: LCS-79377	SampType: LCS	TestCode: EPA 351.2: TKN								
Client ID: LCSW	Batch ID: 79377	RunNo: 101842								
Prep Date: 12/14/2023	Analysis Date: 12/14/2023	SeqNo: 3760876	Units: mg/L							
Analyte	Result	PQL	SPK value	SPK Ref Val	%REC	LowLimit	HighLimit	%RPD	RPDLimit	Qual
Nitrogen, Kjeldahl, Total	9.9	0.50	10.00	0	99.1	90	110			

Sample ID: 2311B70-001AMS	SampType: MS	TestCode: EPA 351.2: TKN								
Client ID: 833-08	Batch ID: 79377	RunNo: 101842								
Prep Date: 12/14/2023	Analysis Date: 12/14/2023	SeqNo: 3760892	Units: mg/L							
Analyte	Result	PQL	SPK value	SPK Ref Val	%REC	LowLimit	HighLimit	%RPD	RPDLimit	Qual
Nitrogen, Kjeldahl, Total	2.1	0.50	10.00	0	21.4	90	110			S

Sample ID: 2311B70-001AMSD	SampType: MSD	TestCode: EPA 351.2: TKN								
Client ID: 833-08	Batch ID: 79377	RunNo: 101842								
Prep Date: 12/14/2023	Analysis Date: 12/14/2023	SeqNo: 3760893	Units: mg/L							
Analyte	Result	PQL	SPK value	SPK Ref Val	%REC	LowLimit	HighLimit	%RPD	RPDLimit	Qual
Nitrogen, Kjeldahl, Total	2.1	0.50	10.00	0	21.3	90	110	0.730	0	S

Qualifiers:

- * Value exceeds Maximum Contaminant Level.
- D Sample Diluted Due to Matrix
- H Holding times for preparation or analysis exceeded
- ND Not Detected at the Reporting Limit
- PQL Practical Quantitative Limit
- S % Recovery outside of standard limits. If undiluted results may be estimated.
- B Analyte detected in the associated Method Blank
- E Above Quantitation Range/Estimated Value
- J Analyte detected below quantitation limits
- P Sample pH Not In Range
- RL Reporting Limit

Sample Log-In Check List

Client Name: **EA Engineering** Work Order Number: **2311B70** RcptNo: **1**

Received By: **Juan Rojas** 11/22/2023 9:40:00 AM *Juan Rojas*

Completed By: **Cheyenne Cason** 11/22/2023 11:48:05 AM *Cason*

Reviewed By: *JC 11-22-23*

Chain of Custody

1. Is Chain of Custody complete? Yes No Not Present
2. How was the sample delivered? FedEx

Log In

3. Was an attempt made to cool the samples? Yes No NA
4. Were all samples received at a temperature of >0° C to 6.0°C Yes No NA
5. Sample(s) in proper container(s)? Yes No
6. Sufficient sample volume for indicated test(s)? Yes No
7. Are samples (except VOA and ONG) properly preserved? Yes No
8. Was preservative added to bottles? Yes No NA
9. Received at least 1 vial with headspace <1/4" for AQ VOA? Yes No NA
10. Were any sample containers received broken? Yes No
11. Does paperwork match bottle labels? Yes No
(Note discrepancies on chain of custody)
12. Are matrices correctly identified on Chain of Custody? Yes No
13. Is it clear what analyses were requested? Yes No
14. Were all holding times able to be met? Yes No
(If no, notify customer for authorization.)

of preserved bottles checked for pH: 3
(≤3 or >12 unless noted)

Adjusted? NO

Checked by: TMC 11/22/23

Special Handling (if applicable)

15. Was client notified of all discrepancies with this order? Yes No NA

Person Notified: _____ Date: _____

By Whom: _____ Via: eMail Phone Fax In Person

Regarding: _____

Client Instructions: _____

16. Additional remarks:

17. **Cooler Information**

Cooler No	Temp °C	Condition	Seal Intact	Seal No	Seal Date	Signed By
1	0.8	Good	Not Present	Yogi		

Chain-of-Custody Record

Client: EA Engineering, Science, and Technology
 Mailing Address: 320 Gold Ave SW Suite
 Phone #: 505-715-4279
 email or Fax#: rmullen@eaest.com

QA/QC Package: Standard Level 4 (Full Validation)
 Accreditation: Az Compliance Other
 NELAC Other
 EDD (Type)

Turn-Around Time: Standard Rush

Project Name: Big Sky Dairy

Project #: 4901 Hawkins NE - Albuquerque, NM 87109

Project Manager: Gina Mullen

Sampler: Angel N. Rivera

On Ice: Yes No

of Coolers: 1

Cooler Temp (including dry): 6.9-0.1-0.8

Container Type and #

Preservative Type

HEAL No. 2311376

2 001

2 002

2 003

Date Time

11-21 10:37 AM

11-21 12:35 PM

11-21 16:10 PM

Date Time

11-24 17:50

Date Time

11-22-23 9:40

Date Time

Date Time

Date Time

Date Time

Date Time

Date Time

Analysis Request

Nitrate/Nitrites EPA Method 300

TKN SM 4500 NORG C

Chloride EPA 300

TDS SM 2540 C MOD

Sulfate EPA 300

Phosphorus EPA 6010B

Total Sulfur

Remarks:

Received by: [Signature]

Via: FedEx

Date Time

11/22/23 9:40

Received by:

Via:

Date Time

Date Time

Date Time

Date Time

Date Time

Date Time

Date Time

Date Time

Date Time

Date Time

Date Time

Date Time

Date Time

Date Time

Date Time

Date Time



HALL ENVIRONMENTAL ANALYSIS LABORATORY

www.hallenvironmental.com

4901 Hawkins NE - Albuquerque, NM 87109

Tel. 505-345-3975 Fax 505-345-4107

If necessary, samples submitted to Hall Environmental may be subcontracted to other accredited laboratories. This serves as notice of this possibility. Any sub-contracted data will be clearly notated on the analytical report.

December 28, 2023

Regina Mullen
EA Engineering
320 Gold Ave SW Suite 1210
Albuquerque, NM 87102
TEL:
FAX:

RE: Big Sky Dairy

OrderNo.: 2311C54

Dear Regina Mullen:

Eurofins Environment Testing South Central, LLC received 2 sample(s) on 11/28/2023 for the analyses presented in the following report.

These were analyzed according to EPA procedures or equivalent. To access our accredited tests please go to www.hallenvironmental.com or the state specific web sites. In order to properly interpret your results, it is imperative that you review this report in its entirety. See the sample checklist and/or the Chain of Custody for information regarding the sample receipt temperature and preservation. Data qualifiers or a narrative will be provided if the sample analysis or analytical quality control parameters require a flag. When necessary, data qualifiers are provided on both the sample analysis report and the QC summary report, both sections should be reviewed. All samples are reported, as received, unless otherwise indicated. Lab measurement of analytes considered field parameters that require analysis within 15 minutes of sampling such as pH and residual chlorine are qualified as being analyzed outside of the recommended holding time.

Please do not hesitate to contact Eurofins Albuquerque for any additional information or clarifications.

ADHS Cert #AZ0682 -- NMED-DWB Cert #NM9425 -- NMED-Micro Cert #NM0901

Sincerely,



Andy Freeman
Laboratory Manager
4901 Hawkins NE
Albuquerque, NM 87109

Hall Environmental Analysis Laboratory, Inc.

Analytical Report

Lab Order 2311C54

Date Reported: 12/28/2023

CLIENT: EA Engineering

Client Sample ID: 833-09

Project: Big Sky Dairy

Collection Date: 11/27/2023 11:15:00 AM

Lab ID: 2311C54-001

Matrix: GROUNDWA

Received Date: 11/28/2023 9:15:00 AM

Analyses	Result	RL	Qual	Units	DF	Date Analyzed	Batch
EPA METHOD 300.0: ANIONS							Analyst: RBC
Chloride	830	50	*	mg/L	100	11/28/2023 3:23:39 PM	R101462
Nitrogen, Nitrite (As N)	ND	1.0		mg/L	10	11/28/2023 3:10:47 PM	R101462
Nitrogen, Nitrate (As N)	64	1.0	*	mg/L	10	11/28/2023 3:10:47 PM	R101462
Sulfate	670	50	*	mg/L	100	11/28/2023 3:23:39 PM	R101462
SM2540C MOD: TOTAL DISSOLVED SOLIDS							Analyst: KS
Total Dissolved Solids	3500	50.0	*	mg/L	1	11/30/2023 6:05:00 PM	79063
EPA 351.2: TKN							Analyst: DML
Nitrogen, Kjeldahl, Total	ND	0.50		mg/L	1	12/14/2023 5:45:11 PM	79378

Refer to the QC Summary report and sample login checklist for flagged QC data and preservation information.

Qualifiers:	*	Value exceeds Maximum Contaminant Level.	B	Analyte detected in the associated Method Blank
	D	Sample Diluted Due to Matrix	E	Above Quantitation Range/Estimated Value
	H	Holding times for preparation or analysis exceeded	J	Analyte detected below quantitation limits
	ND	Not Detected at the Reporting Limit	P	Sample pH Not In Range
	PQL	Practical Quantitative Limit	RL	Reporting Limit
	S	% Recovery outside of standard limits. If undiluted results may be estimated.		

Hall Environmental Analysis Laboratory, Inc.

Analytical Report

Lab Order 2311C54

Date Reported: 12/28/2023

CLIENT: EA Engineering

Client Sample ID: 833-10

Project: Big Sky Dairy

Collection Date: 11/27/2023 1:20:00 PM

Lab ID: 2311C54-002

Matrix: GROUNDWA

Received Date: 11/28/2023 9:15:00 AM

Analyses	Result	RL	Qual	Units	DF	Date Analyzed	Batch
EPA METHOD 300.0: ANIONS							Analyst: RBC
Chloride	710	50	*	mg/L	100	11/28/2023 3:49:22 PM	R101462
Nitrogen, Nitrite (As N)	ND	1.0		mg/L	10	11/28/2023 3:36:30 PM	R101462
Nitrogen, Nitrate (As N)	3.2	1.0		mg/L	10	11/28/2023 3:36:30 PM	R101462
Sulfate	470	50	*	mg/L	100	11/28/2023 3:49:22 PM	R101462
SM2540C MOD: TOTAL DISSOLVED SOLIDS							Analyst: KS
Total Dissolved Solids	2770	50.0	*	mg/L	1	11/30/2023 6:05:00 PM	79063
EPA 351.2: TKN							Analyst: DML
Nitrogen, Kjeldahl, Total	0.92	0.50		mg/L	1	12/14/2023 5:46:41 PM	79378

Refer to the QC Summary report and sample login checklist for flagged QC data and preservation information.

Qualifiers:	*	Value exceeds Maximum Contaminant Level.	B	Analyte detected in the associated Method Blank
	D	Sample Diluted Due to Matrix	E	Above Quantitation Range/Estimated Value
	H	Holding times for preparation or analysis exceeded	J	Analyte detected below quantitation limits
	ND	Not Detected at the Reporting Limit	P	Sample pH Not In Range
	PQL	Practical Quantitative Limit	RL	Reporting Limit
	S	% Recovery outside of standard limits. If undiluted results may be estimated.		

QC SUMMARY REPORT

Hall Environmental Analysis Laboratory, Inc.

WO#: 2311C54

28-Dec-23

Client: EA Engineering
Project: Big Sky Dairy

Sample ID: MB	SampType: MBLK	TestCode: EPA Method 300.0: Anions								
Client ID: PBW	Batch ID: R101462	RunNo: 101462								
Prep Date:	Analysis Date: 11/28/2023	SeqNo: 3733607	Units: mg/L							
Analyte	Result	PQL	SPK value	SPK Ref Val	%REC	LowLimit	HighLimit	%RPD	RPDLimit	Qual
Chloride	ND	0.50								
Nitrogen, Nitrite (As N)	ND	0.10								
Nitrogen, Nitrate (As N)	ND	0.10								
Sulfate	ND	0.50								

Sample ID: LCS	SampType: LCS	TestCode: EPA Method 300.0: Anions								
Client ID: LCSW	Batch ID: R101462	RunNo: 101462								
Prep Date:	Analysis Date: 11/28/2023	SeqNo: 3733608	Units: mg/L							
Analyte	Result	PQL	SPK value	SPK Ref Val	%REC	LowLimit	HighLimit	%RPD	RPDLimit	Qual
Chloride	4.7	0.50	5.000	0	94.4	90	110			
Nitrogen, Nitrite (As N)	0.96	0.10	1.000	0	96.4	90	110			
Nitrogen, Nitrate (As N)	2.5	0.10	2.500	0	98.3	90	110			
Sulfate	9.6	0.50	10.00	0	96.4	90	110			

Qualifiers:

- * Value exceeds Maximum Contaminant Level.
- D Sample Diluted Due to Matrix
- H Holding times for preparation or analysis exceeded
- ND Not Detected at the Reporting Limit
- PQL Practical Quantitative Limit
- S % Recovery outside of standard limits. If undiluted results may be estimated.
- B Analyte detected in the associated Method Blank
- E Above Quantitation Range/Estimated Value
- J Analyte detected below quantitation limits
- P Sample pH Not In Range
- RL Reporting Limit

QC SUMMARY REPORT

Hall Environmental Analysis Laboratory, Inc.

WO#: 2311C54

28-Dec-23

Client: EA Engineering
Project: Big Sky Dairy

Sample ID: MB-79063	SampType: MBLK	TestCode: SM2540C MOD: Total Dissolved Solids								
Client ID: PBW	Batch ID: 79063	RunNo: 101508								
Prep Date: 11/29/2023	Analysis Date: 11/30/2023	SeqNo: 3736457	Units: mg/L							
Analyte	Result	PQL	SPK value	SPK Ref Val	%REC	LowLimit	HighLimit	%RPD	RPDLimit	Qual
Total Dissolved Solids	ND	50.0								

Sample ID: LCS-79063	SampType: LCS	TestCode: SM2540C MOD: Total Dissolved Solids								
Client ID: LCSW	Batch ID: 79063	RunNo: 101508								
Prep Date: 11/29/2023	Analysis Date: 11/30/2023	SeqNo: 3736458	Units: mg/L							
Analyte	Result	PQL	SPK value	SPK Ref Val	%REC	LowLimit	HighLimit	%RPD	RPDLimit	Qual
Total Dissolved Solids	1070	50.0	1000	0	107	80	120			

Qualifiers:

- * Value exceeds Maximum Contaminant Level.
- D Sample Diluted Due to Matrix
- H Holding times for preparation or analysis exceeded
- ND Not Detected at the Reporting Limit
- PQL Practical Quantitative Limit
- S % Recovery outside of standard limits. If undiluted results may be estimated.
- B Analyte detected in the associated Method Blank
- E Above Quantitation Range/Estimated Value
- J Analyte detected below quantitation limits
- P Sample pH Not In Range
- RL Reporting Limit

QC SUMMARY REPORT

Hall Environmental Analysis Laboratory, Inc.

WO#: 2311C54

28-Dec-23

Client: EA Engineering
Project: Big Sky Dairy

Sample ID: MB-79378	SampType: MBLK	TestCode: EPA 351.2: TKN								
Client ID: PBW	Batch ID: 79378	RunNo: 101842								
Prep Date: 12/14/2023	Analysis Date: 12/14/2023	SeqNo: 3760905	Units: mg/L							
Analyte	Result	PQL	SPK value	SPK Ref Val	%REC	LowLimit	HighLimit	%RPD	RPDLimit	Qual
Nitrogen, Kjeldahl, Total	ND	0.50								

Sample ID: LCSLL-79378	SampType: LCSLL	TestCode: EPA 351.2: TKN								
Client ID: BatchQC	Batch ID: 79378	RunNo: 101842								
Prep Date: 12/14/2023	Analysis Date: 12/14/2023	SeqNo: 3760906	Units: mg/L							
Analyte	Result	PQL	SPK value	SPK Ref Val	%REC	LowLimit	HighLimit	%RPD	RPDLimit	Qual
Nitrogen, Kjeldahl, Total	0.50	0	0.5000	0	99.3	50	150			

Sample ID: LCS-79378	SampType: LCS	TestCode: EPA 351.2: TKN								
Client ID: LCSW	Batch ID: 79378	RunNo: 101842								
Prep Date: 12/14/2023	Analysis Date: 12/14/2023	SeqNo: 3760907	Units: mg/L							
Analyte	Result	PQL	SPK value	SPK Ref Val	%REC	LowLimit	HighLimit	%RPD	RPDLimit	Qual
Nitrogen, Kjeldahl, Total	10	0.50	10.00	0	102	90	110			

Qualifiers:

- * Value exceeds Maximum Contaminant Level.
- D Sample Diluted Due to Matrix
- H Holding times for preparation or analysis exceeded
- ND Not Detected at the Reporting Limit
- PQL Practical Quantitative Limit
- S % Recovery outside of standard limits. If undiluted results may be estimated.
- B Analyte detected in the associated Method Blank
- E Above Quantitation Range/Estimated Value
- J Analyte detected below quantitation limits
- P Sample pH Not In Range
- RL Reporting Limit

Sample Log-In Check List

Client Name: EA Engineering Work Order Number: 2311C54 RcptNo: 1

Received By: Juan Rojas 11/28/2023 9:15:00 AM *Juan Rojas*

Completed By: Desiree Dominguez 11/28/2023 9:49:58 AM *DD*

Reviewed By: *ju 11/28/23*

Chain of Custody

1. Is Chain of Custody complete? Yes No Not Present
2. How was the sample delivered? FedEx

Log In

3. Was an attempt made to cool the samples? Yes No NA
4. Were all samples received at a temperature of >0° C to 6.0°C Yes No NA
5. Sample(s) in proper container(s)? Yes No
6. Sufficient sample volume for indicated test(s)? Yes No
7. Are samples (except VOA and ONG) properly preserved? Yes No
8. Was preservative added to bottles? Yes No NA
9. Received at least 1 vial with headspace <1/4" for AQ VOA? Yes No NA
10. Were any sample containers received broken? Yes No
11. Does paperwork match bottle labels? Yes No
(Note discrepancies on chain of custody)
12. Are matrices correctly identified on Chain of Custody? Yes No
13. Is it clear what analyses were requested? Yes No
14. Were all holding times able to be met? Yes No
(If no, notify customer for authorization.)

of preserved bottles checked for pH: 7
(2) or >12 unless noted

Adjusted? NO

Checked by: SEM 11/28/23

Special Handling (if applicable)

15. Was client notified of all discrepancies with this order? Yes No NA

Person Notified: _____ Date: _____

By Whom: _____ Via: eMail Phone Fax In Person

Regarding: _____

Client Instructions: _____

16. Additional remarks:

17. Cooler Information

Cooler No	Temp °C	Condition	Seal Intact	Seal No	Seal Date	Signed By
1	0.7	Good	Not Present	Morty		

December 28, 2023

Regina Mullen
EA Engineering
320 Gold Ave SW Suite 1210
Albuquerque, NM 87102
TEL:
FAX:

RE: Sunset Dairy

OrderNo.: 2311D32

Dear Regina Mullen:

Eurofins Environment Testing South Central, LLC received 3 sample(s) on 11/29/2023 for the analyses presented in the following report.

These were analyzed according to EPA procedures or equivalent. To access our accredited tests please go to www.hallenvironmental.com or the state specific web sites. In order to properly interpret your results, it is imperative that you review this report in its entirety. See the sample checklist and/or the Chain of Custody for information regarding the sample receipt temperature and preservation. Data qualifiers or a narrative will be provided if the sample analysis or analytical quality control parameters require a flag. When necessary, data qualifiers are provided on both the sample analysis report and the QC summary report, both sections should be reviewed. All samples are reported, as received, unless otherwise indicated. Lab measurement of analytes considered field parameters that require analysis within 15 minutes of sampling such as pH and residual chlorine are qualified as being analyzed outside of the recommended holding time.

Please do not hesitate to contact Eurofins Albuquerque for any additional information or clarifications.

ADHS Cert #AZ0682 -- NMED-DWB Cert #NM9425 -- NMED-Micro Cert #NM0901

Sincerely,



Andy Freeman
Laboratory Manager
4901 Hawkins NE
Albuquerque, NM 87109

Hall Environmental Analysis Laboratory, Inc.

Analytical Report

Lab Order 2311D32

Date Reported: 12/28/2023

CLIENT: EA Engineering

Client Sample ID: 257-01

Project: Sunset Dairy

Collection Date: 11/28/2023 11:00:00 AM

Lab ID: 2311D32-001

Matrix: GROUNDWA

Received Date: 11/29/2023 8:55:00 AM

Analyses	Result	RL	Qual	Units	DF	Date Analyzed	Batch
EPA METHOD 300.0: ANIONS							Analyst: SNS
Chloride	890	50	*	mg/L	100	11/29/2023 2:23:21 PM	R101491
Nitrogen, Nitrite (As N)	ND	1.0		mg/L	10	11/29/2023 2:10:30 PM	R101491
Nitrogen, Nitrate (As N)	32	1.0	*	mg/L	10	11/29/2023 2:10:30 PM	R101491
Sulfate	650	50	*	mg/L	100	11/29/2023 2:23:21 PM	R101491
SM2540C MOD: TOTAL DISSOLVED SOLIDS							Analyst: KS
Total Dissolved Solids	3590	100	*D	mg/L	1	12/4/2023 4:42:00 PM	79088
EPA 351.2: TKN							Analyst: DML
Nitrogen, Kjeldahl, Total	ND	0.50		mg/L	1	12/19/2023 3:47:11 PM	79452

Refer to the QC Summary report and sample login checklist for flagged QC data and preservation information.

Qualifiers:	*	Value exceeds Maximum Contaminant Level.	B	Analyte detected in the associated Method Blank
	D	Sample Diluted Due to Matrix	E	Above Quantitation Range/Estimated Value
	H	Holding times for preparation or analysis exceeded	J	Analyte detected below quantitation limits
	ND	Not Detected at the Reporting Limit	P	Sample pH Not In Range
	PQL	Practical Quantitative Limit	RL	Reporting Limit
	S	% Recovery outside of standard limits. If undiluted results may be estimated.		

Hall Environmental Analysis Laboratory, Inc.

Analytical Report

Lab Order 2311D32

Date Reported: 12/28/2023

CLIENT: EA Engineering

Client Sample ID: 257-02

Project: Sunset Dairy

Collection Date: 11/28/2023 12:25:00 PM

Lab ID: 2311D32-002

Matrix: GROUNDWA

Received Date: 11/29/2023 8:55:00 AM

Analyses	Result	RL	Qual	Units	DF	Date Analyzed	Batch
EPA METHOD 300.0: ANIONS							Analyst: SNS
Chloride	650	50	*	mg/L	100	11/29/2023 2:49:04 PM	R101491
Nitrogen, Nitrite (As N)	ND	1.0		mg/L	10	11/29/2023 2:36:12 PM	R101491
Nitrogen, Nitrate (As N)	8.6	1.0		mg/L	10	11/29/2023 2:36:12 PM	R101491
Sulfate	450	50	*	mg/L	100	11/29/2023 2:49:04 PM	R101491
SM2540C MOD: TOTAL DISSOLVED SOLIDS							Analyst: KS
Total Dissolved Solids	2530	50.0	*	mg/L	1	12/4/2023 4:42:00 PM	79088
EPA 351.2: TKN							Analyst: DML
Nitrogen, Kjeldahl, Total	ND	0.50		mg/L	1	12/19/2023 3:48:41 PM	79452

Refer to the QC Summary report and sample login checklist for flagged QC data and preservation information.

Qualifiers:	*	Value exceeds Maximum Contaminant Level.	B	Analyte detected in the associated Method Blank
	D	Sample Diluted Due to Matrix	E	Above Quantitation Range/Estimated Value
	H	Holding times for preparation or analysis exceeded	J	Analyte detected below quantitation limits
	ND	Not Detected at the Reporting Limit	P	Sample pH Not In Range
	PQL	Practical Quantitative Limit	RL	Reporting Limit
	S	% Recovery outside of standard limits. If undiluted results may be estimated.		

Hall Environmental Analysis Laboratory, Inc.

Analytical Report

Lab Order 2311D32

Date Reported: 12/28/2023

CLIENT: EA Engineering

Client Sample ID: MW-4

Project: Sunset Dairy

Collection Date: 11/28/2023 2:45:00 PM

Lab ID: 2311D32-003

Matrix: GROUNDWA

Received Date: 11/29/2023 8:55:00 AM

Analyses	Result	RL	Qual	Units	DF	Date Analyzed	Batch
EPA METHOD 300.0: ANIONS							Analyst: SNS
Chloride	1400	50	*	mg/L	100	11/29/2023 3:17:39 PM	R101491
Nitrogen, Nitrite (As N)	ND	1.0		mg/L	10	11/29/2023 3:04:48 PM	R101491
Nitrogen, Nitrate (As N)	1.1	1.0		mg/L	10	11/29/2023 3:04:48 PM	R101491
Sulfate	1000	50	*	mg/L	100	11/29/2023 3:17:39 PM	R101491
SM2540C MOD: TOTAL DISSOLVED SOLIDS							Analyst: KS
Total Dissolved Solids	4310	100	*D	mg/L	1	12/4/2023 4:42:00 PM	79088
EPA 351.2: TKN							Analyst: DML
Nitrogen, Kjeldahl, Total	ND	0.50		mg/L	1	12/19/2023 3:50:11 PM	79452

Refer to the QC Summary report and sample login checklist for flagged QC data and preservation information.

Qualifiers:	*	Value exceeds Maximum Contaminant Level.	B	Analyte detected in the associated Method Blank
	D	Sample Diluted Due to Matrix	E	Above Quantitation Range/Estimated Value
	H	Holding times for preparation or analysis exceeded	J	Analyte detected below quantitation limits
	ND	Not Detected at the Reporting Limit	P	Sample pH Not In Range
	PQL	Practical Quantitative Limit	RL	Reporting Limit
	S	% Recovery outside of standard limits. If undiluted results may be estimated.		

QC SUMMARY REPORT

Hall Environmental Analysis Laboratory, Inc.

WO#: 2311D32

28-Dec-23

Client: EA Engineering
Project: Sunset Dairy

Sample ID: MB	SampType: MBLK	TestCode: EPA Method 300.0: Anions								
Client ID: PBW	Batch ID: R101491	RunNo: 101491								
Prep Date:	Analysis Date: 11/29/2023	SeqNo: 3735754	Units: mg/L							
Analyte	Result	PQL	SPK value	SPK Ref Val	%REC	LowLimit	HighLimit	%RPD	RPDLimit	Qual

Chloride	ND	0.50								
Nitrogen, Nitrite (As N)	ND	0.10								
Nitrogen, Nitrate (As N)	ND	0.10								
Sulfate	ND	0.50								

Sample ID: LCS	SampType: LCS	TestCode: EPA Method 300.0: Anions								
Client ID: LCSW	Batch ID: R101491	RunNo: 101491								
Prep Date:	Analysis Date: 11/29/2023	SeqNo: 3735755	Units: mg/L							
Analyte	Result	PQL	SPK value	SPK Ref Val	%REC	LowLimit	HighLimit	%RPD	RPDLimit	Qual

Chloride	4.8	0.50	5.000	0	96.5	90	110			
Nitrogen, Nitrite (As N)	0.99	0.10	1.000	0	99.0	90	110			
Nitrogen, Nitrate (As N)	2.5	0.10	2.500	0	100	90	110			
Sulfate	9.7	0.50	10.00	0	96.9	90	110			

Qualifiers:

- * Value exceeds Maximum Contaminant Level.
- D Sample Diluted Due to Matrix
- H Holding times for preparation or analysis exceeded
- ND Not Detected at the Reporting Limit
- PQL Practical Quantitative Limit
- S % Recovery outside of standard limits. If undiluted results may be estimated.
- B Analyte detected in the associated Method Blank
- E Above Quantitation Range/Estimated Value
- J Analyte detected below quantitation limits
- P Sample pH Not In Range
- RL Reporting Limit

QC SUMMARY REPORT

Hall Environmental Analysis Laboratory, Inc.

WO#: 2311D32

28-Dec-23

Client: EA Engineering
Project: Sunset Dairy

Sample ID: MB-79088	SampType: MBLK	TestCode: SM2540C MOD: Total Dissolved Solids								
Client ID: PBW	Batch ID: 79088	RunNo: 101575								
Prep Date: 11/30/2023	Analysis Date: 12/4/2023	SeqNo: 3740326	Units: mg/L							
Analyte	Result	PQL	SPK value	SPK Ref Val	%REC	LowLimit	HighLimit	%RPD	RPDLimit	Qual
Total Dissolved Solids	ND	50.0								

Sample ID: LCS-79088	SampType: LCS	TestCode: SM2540C MOD: Total Dissolved Solids								
Client ID: LCSW	Batch ID: 79088	RunNo: 101575								
Prep Date: 11/30/2023	Analysis Date: 12/4/2023	SeqNo: 3740327	Units: mg/L							
Analyte	Result	PQL	SPK value	SPK Ref Val	%REC	LowLimit	HighLimit	%RPD	RPDLimit	Qual
Total Dissolved Solids	1080	50.0	1000	0	108	80	120			

Sample ID: 2311D32-002ADUP	SampType: DUP	TestCode: SM2540C MOD: Total Dissolved Solids								
Client ID: 257-02	Batch ID: 79088	RunNo: 101575								
Prep Date: 11/30/2023	Analysis Date: 12/4/2023	SeqNo: 3740340	Units: mg/L							
Analyte	Result	PQL	SPK value	SPK Ref Val	%REC	LowLimit	HighLimit	%RPD	RPDLimit	Qual
Total Dissolved Solids	2540	50.0						0.237	10	*

Qualifiers:

- * Value exceeds Maximum Contaminant Level.
- D Sample Diluted Due to Matrix
- H Holding times for preparation or analysis exceeded
- ND Not Detected at the Reporting Limit
- PQL Practical Quantitative Limit
- S % Recovery outside of standard limits. If undiluted results may be estimated.
- B Analyte detected in the associated Method Blank
- E Above Quantitation Range/Estimated Value
- J Analyte detected below quantitation limits
- P Sample pH Not In Range
- RL Reporting Limit

QC SUMMARY REPORT

Hall Environmental Analysis Laboratory, Inc.

WO#: 2311D32

28-Dec-23

Client: EA Engineering
Project: Sunset Dairy

Sample ID: MB-79452	SampType: MBLK	TestCode: EPA 351.2: TKN								
Client ID: PBW	Batch ID: 79452	RunNo: 101956								
Prep Date: 12/18/2023	Analysis Date: 12/19/2023	SeqNo: 3761766	Units: mg/L							
Analyte	Result	PQL	SPK value	SPK Ref Val	%REC	LowLimit	HighLimit	%RPD	RPDLimit	Qual
Nitrogen, Kjeldahl, Total	ND	0.50								

Sample ID: LCSLL-79452	SampType: LCSLL	TestCode: EPA 351.2: TKN								
Client ID: BatchQC	Batch ID: 79452	RunNo: 101956								
Prep Date: 12/18/2023	Analysis Date: 12/19/2023	SeqNo: 3761767	Units: mg/L							
Analyte	Result	PQL	SPK value	SPK Ref Val	%REC	LowLimit	HighLimit	%RPD	RPDLimit	Qual
Nitrogen, Kjeldahl, Total	0.58	0.50	0.5000	0	117	50	150			

Sample ID: LCS-79452	SampType: LCS	TestCode: EPA 351.2: TKN								
Client ID: LCSW	Batch ID: 79452	RunNo: 101956								
Prep Date: 12/18/2023	Analysis Date: 12/19/2023	SeqNo: 3761770	Units: mg/L							
Analyte	Result	PQL	SPK value	SPK Ref Val	%REC	LowLimit	HighLimit	%RPD	RPDLimit	Qual
Nitrogen, Kjeldahl, Total	9.9	0.50	10.00	0	99.5	90	110			

Qualifiers:

- * Value exceeds Maximum Contaminant Level.
- D Sample Diluted Due to Matrix
- H Holding times for preparation or analysis exceeded
- ND Not Detected at the Reporting Limit
- PQL Practical Quantitative Limit
- S % Recovery outside of standard limits. If undiluted results may be estimated.
- B Analyte detected in the associated Method Blank
- E Above Quantitation Range/Estimated Value
- J Analyte detected below quantitation limits
- P Sample pH Not In Range
- RL Reporting Limit

Sample Log-In Check List

Client Name: **EA Engineering** Work Order Number: **2311D32** RcptNo: **1**

Received By: **Steve McQuiston** 11/29/2023 8:55:00 AM *SMC*

Completed By: **Desiree Dominguez** 11/29/2023 9:52:14 AM *DD*

Reviewed By: *SCM 11/29/23*

Chain of Custody

1. Is Chain of Custody complete? Yes No Not Present
2. How was the sample delivered? FedEx

Log In

3. Was an attempt made to cool the samples? Yes No NA
4. Were all samples received at a temperature of >0° C to 6.0°C Yes No NA
5. Sample(s) in proper container(s)? Yes No
6. Sufficient sample volume for indicated test(s)? Yes No
7. Are samples (except VOA and ONG) properly preserved? Yes No
8. Was preservative added to bottles? Yes No NA
9. Received at least 1 vial with headspace <1/4" for AQ VOA? Yes No NA
10. Were any sample containers received broken? Yes No
11. Does paperwork match bottle labels? Yes No
 (Note discrepancies on chain of custody)
12. Are matrices correctly identified on Chain of Custody? Yes No
13. Is it clear what analyses were requested? Yes No
14. Were all holding times able to be met? Yes No
 (If no, notify customer for authorization.)

of preserved bottles checked for pH: 3
 (<2 or >12 unless noted)
 Adjusted? NO
 Checked by: Juu/29/23

Special Handling (if applicable)

15. Was client notified of all discrepancies with this order? Yes No NA

Person Notified: _____ Date: _____
 By Whom: _____ Via: eMail Phone Fax In Person
 Regarding: _____
 Client Instructions: _____

16. Additional remarks:

17. Cooler Information

Cooler No	Temp °C	Condition	Seal Intact	Seal No	Seal Date	Signed By
1	0.2	Good	Not Present	Morty		

December 28, 2023

Regina Mullen
EA Engineering
320 Gold Ave SW Suite 1210
Albuquerque, NM 87102
TEL:
FAX:

RE: Del Oro Dairy

OrderNo.: 2311D94

Dear Regina Mullen:

Eurofins Environment Testing South Central, LLC received 4 sample(s) on 11/30/2023 for the analyses presented in the following report.

These were analyzed according to EPA procedures or equivalent. To access our accredited tests please go to www.hallenvironmental.com or the state specific web sites. In order to properly interpret your results, it is imperative that you review this report in its entirety. See the sample checklist and/or the Chain of Custody for information regarding the sample receipt temperature and preservation. Data qualifiers or a narrative will be provided if the sample analysis or analytical quality control parameters require a flag. When necessary, data qualifiers are provided on both the sample analysis report and the QC summary report, both sections should be reviewed. All samples are reported, as received, unless otherwise indicated. Lab measurement of analytes considered field parameters that require analysis within 15 minutes of sampling such as pH and residual chlorine are qualified as being analyzed outside of the recommended holding time.

Please do not hesitate to contact Eurofins Albuquerque for any additional information or clarifications.

ADHS Cert #AZ0682 -- NMED-DWB Cert #NM9425 -- NMED-Micro Cert #NM0901

Sincerely,



Andy Freeman
Laboratory Manager
4901 Hawkins NE
Albuquerque, NM 87109

Hall Environmental Analysis Laboratory, Inc.

Analytical Report

Lab Order 2311D94

Date Reported: 12/28/2023

CLIENT: EA Engineering

Client Sample ID: EW-05

Project: Del Oro Dairy

Collection Date: 11/29/2023 11:15:00 AM

Lab ID: 2311D94-001

Matrix: GROUNDWA

Received Date: 11/30/2023 9:05:00 AM

Analyses	Result	RL	Qual	Units	DF	Date Analyzed	Batch
EPA METHOD 300.0: ANIONS							Analyst: RBC
Chloride	490	50	*	mg/L	100	11/30/2023 6:14:27 PM	R101516
Nitrogen, Nitrite (As N)	ND	1.0		mg/L	10	11/30/2023 6:01:35 PM	R101516
Nitrogen, Nitrate (As N)	20	1.0	*	mg/L	10	11/30/2023 6:01:35 PM	R101516
Sulfate	260	5.0	*	mg/L	10	11/30/2023 6:01:35 PM	R101516
SM2540C MOD: TOTAL DISSOLVED SOLIDS							Analyst: KS
Total Dissolved Solids	1820	50.0	*	mg/L	1	12/7/2023 4:14:00 PM	79174
EPA 351.2: TKN							Analyst: DML
Nitrogen, Kjeldahl, Total	ND	0.50		mg/L	1	12/19/2023 4:38:31 PM	79480

Refer to the QC Summary report and sample login checklist for flagged QC data and preservation information.

Qualifiers:	*	Value exceeds Maximum Contaminant Level.	B	Analyte detected in the associated Method Blank
	D	Sample Diluted Due to Matrix	E	Above Quantitation Range/Estimated Value
	H	Holding times for preparation or analysis exceeded	J	Analyte detected below quantitation limits
	ND	Not Detected at the Reporting Limit	P	Sample pH Not In Range
	PQL	Practical Quantitative Limit	RL	Reporting Limit
	S	% Recovery outside of standard limits. If undiluted results may be estimated.		

Hall Environmental Analysis Laboratory, Inc.

Analytical Report

Lab Order 2311D94

Date Reported: 12/28/2023

CLIENT: EA Engineering

Client Sample ID: 692-02

Project: Del Oro Dairy

Collection Date: 11/29/2023 1:18:00 PM

Lab ID: 2311D94-002

Matrix: GROUNDWA

Received Date: 11/30/2023 9:05:00 AM

Analyses	Result	RL	Qual	Units	DF	Date Analyzed	Batch
EPA METHOD 300.0: ANIONS							Analyst: RBC
Chloride	450	50	*	mg/L	100	11/30/2023 6:40:11 PM	R101516
Nitrogen, Nitrite (As N)	ND	1.0		mg/L	10	11/30/2023 6:27:18 PM	R101516
Nitrogen, Nitrate (As N)	13	1.0	*	mg/L	10	11/30/2023 6:27:18 PM	R101516
Sulfate	250	5.0		mg/L	10	11/30/2023 6:27:18 PM	R101516
SM2540C MOD: TOTAL DISSOLVED SOLIDS							Analyst: KS
Total Dissolved Solids	1720	50.0	*	mg/L	1	12/7/2023 4:14:00 PM	79174
EPA 351.2: TKN							Analyst: DML
Nitrogen, Kjeldahl, Total	ND	0.50		mg/L	1	12/19/2023 4:40:01 PM	79480

Refer to the QC Summary report and sample login checklist for flagged QC data and preservation information.

Qualifiers:	*	Value exceeds Maximum Contaminant Level.	B	Analyte detected in the associated Method Blank
	D	Sample Diluted Due to Matrix	E	Above Quantitation Range/Estimated Value
	H	Holding times for preparation or analysis exceeded	J	Analyte detected below quantitation limits
	ND	Not Detected at the Reporting Limit	P	Sample pH Not In Range
	PQL	Practical Quantitative Limit	RL	Reporting Limit
	S	% Recovery outside of standard limits. If undiluted results may be estimated.		

Hall Environmental Analysis Laboratory, Inc.

Analytical Report

Lab Order 2311D94

Date Reported: 12/28/2023

CLIENT: EA Engineering

Client Sample ID: EW-04

Project: Del Oro Dairy

Collection Date: 11/29/2023 2:24:00 PM

Lab ID: 2311D94-003

Matrix: GROUNDWA

Received Date: 11/30/2023 9:05:00 AM

Analyses	Result	RL	Qual	Units	DF	Date Analyzed	Batch
EPA METHOD 300.0: ANIONS							Analyst: RBC
Chloride	410	50	*	mg/L	100	11/30/2023 7:05:53 PM	R101516
Nitrogen, Nitrite (As N)	ND	1.0		mg/L	10	11/30/2023 6:53:02 PM	R101516
Nitrogen, Nitrate (As N)	16	1.0	*	mg/L	10	11/30/2023 6:53:02 PM	R101516
Sulfate	210	5.0		mg/L	10	11/30/2023 6:53:02 PM	R101516
SM2540C MOD: TOTAL DISSOLVED SOLIDS							Analyst: KS
Total Dissolved Solids	1470	50.0	*	mg/L	1	12/7/2023 4:14:00 PM	79174
EPA 351.2: TKN							Analyst: DML
Nitrogen, Kjeldahl, Total	1.1	0.50		mg/L	1	12/19/2023 4:41:31 PM	79480

Refer to the QC Summary report and sample login checklist for flagged QC data and preservation information.

Qualifiers:	*	Value exceeds Maximum Contaminant Level.	B	Analyte detected in the associated Method Blank
	D	Sample Diluted Due to Matrix	E	Above Quantitation Range/Estimated Value
	H	Holding times for preparation or analysis exceeded	J	Analyte detected below quantitation limits
	ND	Not Detected at the Reporting Limit	P	Sample pH Not In Range
	PQL	Practical Quantitative Limit	RL	Reporting Limit
	S	% Recovery outside of standard limits. If undiluted results may be estimated.		

Hall Environmental Analysis Laboratory, Inc.

Analytical Report

Lab Order 2311D94

Date Reported: 12/28/2023

CLIENT: EA Engineering

Client Sample ID: EW-02

Project: Del Oro Dairy

Collection Date: 11/29/2023 4:20:00 PM

Lab ID: 2311D94-004

Matrix: GROUNDWA

Received Date: 11/30/2023 9:05:00 AM

Analyses	Result	RL	Qual	Units	DF	Date Analyzed	Batch
EPA METHOD 300.0: ANIONS							Analyst: RBC
Chloride	880	50	*	mg/L	100	11/30/2023 7:31:36 PM	R101516
Nitrogen, Nitrite (As N)	ND	1.0		mg/L	10	11/30/2023 7:18:45 PM	R101516
Nitrogen, Nitrate (As N)	130	10	*	mg/L	100	11/30/2023 7:31:36 PM	R101516
Sulfate	500	50	*	mg/L	100	11/30/2023 7:31:36 PM	R101516
SM2540C MOD: TOTAL DISSOLVED SOLIDS							Analyst: KS
Total Dissolved Solids	3420	50.0	*	mg/L	1	12/7/2023 4:14:00 PM	79174
EPA 351.2: TKN							Analyst: DML
Nitrogen, Kjeldahl, Total	ND	0.50		mg/L	1	12/19/2023 4:43:01 PM	79480

Refer to the QC Summary report and sample login checklist for flagged QC data and preservation information.

Qualifiers:	*	Value exceeds Maximum Contaminant Level.	B	Analyte detected in the associated Method Blank
	D	Sample Diluted Due to Matrix	E	Above Quantitation Range/Estimated Value
	H	Holding times for preparation or analysis exceeded	J	Analyte detected below quantitation limits
	ND	Not Detected at the Reporting Limit	P	Sample pH Not In Range
	PQL	Practical Quantitative Limit	RL	Reporting Limit
	S	% Recovery outside of standard limits. If undiluted results may be estimated.		

QC SUMMARY REPORT

Hall Environmental Analysis Laboratory, Inc.

WO#: 2311D94

28-Dec-23

Client: EA Engineering
Project: Del Oro Dairy

Sample ID: MB	SampType: MBLK	TestCode: EPA Method 300.0: Anions								
Client ID: PBW	Batch ID: R101516	RunNo: 101516								
Prep Date:	Analysis Date: 11/30/2023	SeqNo: 3736673	Units: mg/L							

Analyte	Result	PQL	SPK value	SPK Ref Val	%REC	LowLimit	HighLimit	%RPD	RPDLimit	Qual
Chloride	ND	0.50								
Nitrogen, Nitrite (As N)	ND	0.10								
Nitrogen, Nitrate (As N)	ND	0.10								
Sulfate	ND	0.50								

Sample ID: LCS	SampType: LCS	TestCode: EPA Method 300.0: Anions								
Client ID: LCSW	Batch ID: R101516	RunNo: 101516								
Prep Date:	Analysis Date: 11/30/2023	SeqNo: 3736674	Units: mg/L							

Analyte	Result	PQL	SPK value	SPK Ref Val	%REC	LowLimit	HighLimit	%RPD	RPDLimit	Qual
Chloride	4.7	0.50	5.000	0	94.3	90	110			
Nitrogen, Nitrite (As N)	0.96	0.10	1.000	0	96.3	90	110			
Nitrogen, Nitrate (As N)	2.4	0.10	2.500	0	97.7	90	110			
Sulfate	9.5	0.50	10.00	0	95.4	90	110			

Qualifiers:

- * Value exceeds Maximum Contaminant Level.
- D Sample Diluted Due to Matrix
- H Holding times for preparation or analysis exceeded
- ND Not Detected at the Reporting Limit
- PQL Practical Quantitative Limit
- S % Recovery outside of standard limits. If undiluted results may be estimated.
- B Analyte detected in the associated Method Blank
- E Above Quantitation Range/Estimated Value
- J Analyte detected below quantitation limits
- P Sample pH Not In Range
- RL Reporting Limit

QC SUMMARY REPORT

Hall Environmental Analysis Laboratory, Inc.

WO#: 2311D94

28-Dec-23

Client: EA Engineering
Project: Del Oro Dairy

Sample ID: MB-79174	SampType: MBLK	TestCode: SM2540C MOD: Total Dissolved Solids								
Client ID: PBW	Batch ID: 79174	RunNo: 101684								
Prep Date: 12/6/2023	Analysis Date: 12/7/2023	SeqNo: 3745622	Units: mg/L							
Analyte	Result	PQL	SPK value	SPK Ref Val	%REC	LowLimit	HighLimit	%RPD	RPDLimit	Qual
Total Dissolved Solids	ND	50.0								

Sample ID: LCS-79174	SampType: LCS	TestCode: SM2540C MOD: Total Dissolved Solids								
Client ID: LCSW	Batch ID: 79174	RunNo: 101684								
Prep Date: 12/6/2023	Analysis Date: 12/7/2023	SeqNo: 3745623	Units: mg/L							
Analyte	Result	PQL	SPK value	SPK Ref Val	%REC	LowLimit	HighLimit	%RPD	RPDLimit	Qual
Total Dissolved Solids	1070	50.0	1000	0	107	80	120			

Sample ID: 2311D94-001ADUP	SampType: DUP	TestCode: SM2540C MOD: Total Dissolved Solids								
Client ID: EW-05	Batch ID: 79174	RunNo: 101684								
Prep Date: 12/6/2023	Analysis Date: 12/7/2023	SeqNo: 3745625	Units: mg/L							
Analyte	Result	PQL	SPK value	SPK Ref Val	%REC	LowLimit	HighLimit	%RPD	RPDLimit	Qual
Total Dissolved Solids	1800	50.0						0.993	10	*

Qualifiers:

- * Value exceeds Maximum Contaminant Level.
- D Sample Diluted Due to Matrix
- H Holding times for preparation or analysis exceeded
- ND Not Detected at the Reporting Limit
- PQL Practical Quantitative Limit
- S % Recovery outside of standard limits. If undiluted results may be estimated.
- B Analyte detected in the associated Method Blank
- E Above Quantitation Range/Estimated Value
- J Analyte detected below quantitation limits
- P Sample pH Not In Range
- RL Reporting Limit

QC SUMMARY REPORT

Hall Environmental Analysis Laboratory, Inc.

WO#: 2311D94

28-Dec-23

Client: EA Engineering
Project: Del Oro Dairy

Sample ID: MB-79480	SampType: MBLK	TestCode: EPA 351.2: TKN								
Client ID: PBW	Batch ID: 79480	RunNo: 101956								
Prep Date: 12/19/2023	Analysis Date: 12/19/2023	SeqNo: 3761847	Units: mg/L							
Analyte	Result	PQL	SPK value	SPK Ref Val	%REC	LowLimit	HighLimit	%RPD	RPDLimit	Qual
Nitrogen, Kjeldahl, Total	ND	0.50								

Sample ID: LCSLL-79480	SampType: LCSLL	TestCode: EPA 351.2: TKN								
Client ID: BatchQC	Batch ID: 79480	RunNo: 101956								
Prep Date: 12/19/2023	Analysis Date: 12/19/2023	SeqNo: 3761848	Units: mg/L							
Analyte	Result	PQL	SPK value	SPK Ref Val	%REC	LowLimit	HighLimit	%RPD	RPDLimit	Qual
Nitrogen, Kjeldahl, Total	0.48	0	0.5000	0	96.7	50	150			

Sample ID: LCS-79480	SampType: LCS	TestCode: EPA 351.2: TKN								
Client ID: LCSW	Batch ID: 79480	RunNo: 101956								
Prep Date: 12/19/2023	Analysis Date: 12/19/2023	SeqNo: 3761849	Units: mg/L							
Analyte	Result	PQL	SPK value	SPK Ref Val	%REC	LowLimit	HighLimit	%RPD	RPDLimit	Qual
Nitrogen, Kjeldahl, Total	9.8	0.50	10.00	0	97.6	90	110			

Qualifiers:

- | | |
|---|---|
| * Value exceeds Maximum Contaminant Level. | B Analyte detected in the associated Method Blank |
| D Sample Diluted Due to Matrix | E Above Quantitation Range/Estimated Value |
| H Holding times for preparation or analysis exceeded | J Analyte detected below quantitation limits |
| ND Not Detected at the Reporting Limit | P Sample pH Not In Range |
| PQL Practical Quantitative Limit | RL Reporting Limit |
| S % Recovery outside of standard limits. If undiluted results may be estimated. | |

Sample Log-In Check List

Client Name: **EA Engineering** Work Order Number: **2311D94** RcptNo: **1**
 Received By: **Joseph Alderette** 11/30/2023 9:05:00 AM
 Completed By: **Cheyenne Cason** 11/30/2023 9:39:13 AM
 Reviewed By: **SCM 11/30/23**

[Handwritten initials]

Chain of Custody

1. Is Chain of Custody complete? Yes No Not Present
 2. How was the sample delivered? FedEx

Log In

3. Was an attempt made to cool the samples? Yes No NA
 4. Were all samples received at a temperature of >0° C to 6.0°C Yes No NA
 5. Sample(s) in proper container(s)? Yes No
 6. Sufficient sample volume for indicated test(s)? Yes No
 7. Are samples (except VOA and ONG) properly preserved? Yes No
 8. Was preservative added to bottles? Yes No NA
 9. Received at least 1 vial with headspace <1/4" for AQ VOA? Yes No NA
 10. Were any sample containers received broken? Yes No
 11. Does paperwork match bottle labels? Yes No
 (Note discrepancies on chain of custody)
 12. Are matrices correctly identified on Chain of Custody? Yes No
 13. Is it clear what analyses were requested? Yes No
 14. Were all holding times able to be met? Yes No
 (If no, notify customer for authorization.)

of preserved bottles checked for pH: 4
 (<2 or >12 unless noted)
 Adjusted? NO
 Checked by: ju 11/30/23

Special Handling (if applicable)

15. Was client notified of all discrepancies with this order? Yes No NA

Person Notified: _____ Date: _____
 By Whom: _____ Via: eMail Phone Fax In Person
 Regarding: _____
 Client Instructions: _____

16. Additional remarks: Project name missing on COC. Mitzelers

17. Cooler Information

Cooler No	Temp °C	Condition	Seal Intact	Seal No	Seal Date	Signed By
1	0.9	Good	Not Present	Morty		

December 05, 2023

Regina Mullen
EA Engineering
320 Gold Ave SW Suite 1210
Albuquerque, NM 87102
TEL:
FAX:

RE: Bright Star Dairy

OrderNo.: 2311473

Dear Regina Mullen:

Eurofins Environment Testing South Central, LLC received 3 sample(s) on 11/9/2023 for the analyses presented in the following report.

These were analyzed according to EPA procedures or equivalent. To access our accredited tests please go to www.hallenvironmental.com or the state specific web sites. In order to properly interpret your results, it is imperative that you review this report in its entirety. See the sample checklist and/or the Chain of Custody for information regarding the sample receipt temperature and preservation. Data qualifiers or a narrative will be provided if the sample analysis or analytical quality control parameters require a flag. When necessary, data qualifiers are provided on both the sample analysis report and the QC summary report, both sections should be reviewed. All samples are reported, as received, unless otherwise indicated. Lab measurement of analytes considered field parameters that require analysis within 15 minutes of sampling such as pH and residual chlorine are qualified as being analyzed outside of the recommended holding time.

Please do not hesitate to contact Eurofins Albuquerque for any additional information or clarifications.

ADHS Cert #AZ0682 -- NMED-DWB Cert #NM9425 -- NMED-Micro Cert #NM0901

Sincerely,



Andy Freeman
Laboratory Manager
4901 Hawkins NE
Albuquerque, NM 87109

Hall Environmental Analysis Laboratory, Inc.

Analytical Report

Lab Order 2311473

Date Reported: 12/5/2023

CLIENT: EA Engineering

Client Sample ID: 86/340-01

Project: Bright Star Dairy

Collection Date: 11/8/2023 11:30:00 AM

Lab ID: 2311473-001

Matrix: GROUNDWA

Received Date: 11/9/2023 8:35:00 AM

Analyses	Result	RL	Qual	Units	DF	Date Analyzed	Batch
EPA METHOD 300.0: ANIONS							Analyst: JMT
Chloride	260	50	*	mg/L	100	11/10/2023 9:54:23 AM	R101127
Nitrogen, Nitrite (As N)	ND	1.0		mg/L	10	11/10/2023 9:41:31 AM	R101127
Nitrogen, Nitrate (As N)	2.3	1.0		mg/L	10	11/10/2023 9:41:31 AM	R101127
Sulfate	840	50	*	mg/L	100	11/10/2023 9:54:23 AM	R101127
SM2540C MOD: TOTAL DISSOLVED SOLIDS							Analyst: MCA
Total Dissolved Solids	2250	100	*D	mg/L	1	11/10/2023 3:49:00 PM	78696
EPA 351.2: TKN							Analyst: DML
Nitrogen, Kjeldahl, Total	ND	0.50		mg/L	1	11/28/2023 5:04:54 PM	79018

Refer to the QC Summary report and sample login checklist for flagged QC data and preservation information.

Qualifiers:	*	Value exceeds Maximum Contaminant Level.	B	Analyte detected in the associated Method Blank
	D	Sample Diluted Due to Matrix	E	Above Quantitation Range/Estimated Value
	H	Holding times for preparation or analysis exceeded	J	Analyte detected below quantitation limits
	ND	Not Detected at the Reporting Limit	P	Sample pH Not In Range
	PQL	Practical Quantitative Limit	RL	Reporting Limit
	S	% Recovery outside of standard limits. If undiluted results may be estimated.		

Hall Environmental Analysis Laboratory, Inc.

Analytical Report

Lab Order 2311473

Date Reported: 12/5/2023

CLIENT: EA Engineering

Client Sample ID: 70/86/340-01

Project: Bright Star Dairy

Collection Date: 11/8/2023 1:50:00 PM

Lab ID: 2311473-002

Matrix: GROUNDWA

Received Date: 11/9/2023 8:35:00 AM

Analyses	Result	RL	Qual	Units	DF	Date Analyzed	Batch
EPA METHOD 300.0: ANIONS							Analyst: RBC
Chloride	1900	100	*	mg/L	200	11/20/2023 6:56:57 PM	R101328
Nitrogen, Nitrite (As N)	ND	1.0		mg/L	10	11/10/2023 10:07:15 AM	R101127
Nitrogen, Nitrate (As N)	33	1.0	*	mg/L	10	11/10/2023 10:07:15 AM	R101127
Sulfate	1600	50	*	mg/L	100	11/10/2023 10:20:07 AM	R101127
SM2540C MOD: TOTAL DISSOLVED SOLIDS							Analyst: MCA
Total Dissolved Solids	6290	50.0	*	mg/L	1	11/10/2023 3:49:00 PM	78696
EPA 351.2: TKN							Analyst: DML
Nitrogen, Kjeldahl, Total	0.54	0.50		mg/L	1	11/28/2023 5:09:24 PM	79018

Refer to the QC Summary report and sample login checklist for flagged QC data and preservation information.

Qualifiers:	*	Value exceeds Maximum Contaminant Level.	B	Analyte detected in the associated Method Blank
	D	Sample Diluted Due to Matrix	E	Above Quantitation Range/Estimated Value
	H	Holding times for preparation or analysis exceeded	J	Analyte detected below quantitation limits
	ND	Not Detected at the Reporting Limit	P	Sample pH Not In Range
	PQL	Practical Quantitative Limit	RL	Reporting Limit
	S	% Recovery outside of standard limits. If undiluted results may be estimated.		

Hall Environmental Analysis Laboratory, Inc.

Analytical Report

Lab Order 2311473

Date Reported: 12/5/2023

CLIENT: EA Engineering

Client Sample ID: 340-01

Project: Bright Star Dairy

Collection Date: 11/8/2023 3:45:00 PM

Lab ID: 2311473-003

Matrix: GROUNDWA

Received Date: 11/9/2023 8:35:00 AM

Analyses	Result	RL	Qual	Units	DF	Date Analyzed	Batch
EPA METHOD 300.0: ANIONS							Analyst: JMT
Chloride	630	50	*	mg/L	100	11/10/2023 10:45:49 AM	R101127
Nitrogen, Nitrite (As N)	ND	1.0		mg/L	10	11/10/2023 10:32:58 AM	R101127
Nitrogen, Nitrate (As N)	67	1.0	*	mg/L	10	11/10/2023 10:32:58 AM	R101127
Sulfate	480	50	*	mg/L	100	11/10/2023 10:45:49 AM	R101127
SM2540C MOD: TOTAL DISSOLVED SOLIDS							Analyst: MCA
Total Dissolved Solids	2740	250	*D	mg/L	1	11/10/2023 3:49:00 PM	78696
EPA 351.2: TKN							Analyst: DML
Nitrogen, Kjeldahl, Total	ND	2.5	D	mg/L	1	11/28/2023 5:10:54 PM	79018

Refer to the QC Summary report and sample login checklist for flagged QC data and preservation information.

Qualifiers:	*	Value exceeds Maximum Contaminant Level.	B	Analyte detected in the associated Method Blank
	D	Sample Diluted Due to Matrix	E	Above Quantitation Range/Estimated Value
	H	Holding times for preparation or analysis exceeded	J	Analyte detected below quantitation limits
	ND	Not Detected at the Reporting Limit	P	Sample pH Not In Range
	PQL	Practical Quantitative Limit	RL	Reporting Limit
	S	% Recovery outside of standard limits. If undiluted results may be estimated.		

QC SUMMARY REPORT

Hall Environmental Analysis Laboratory, Inc.

WO#: 2311473

05-Dec-23

Client: EA Engineering
Project: Bright Star Dairy

Sample ID: MB	SampType: mblk	TestCode: EPA Method 300.0: Anions								
Client ID: PBW	Batch ID: R101127	RunNo: 101127								
Prep Date:	Analysis Date: 11/10/2023	SeqNo: 3714135	Units: mg/L							
Analyte	Result	PQL	SPK value	SPK Ref Val	%REC	LowLimit	HighLimit	%RPD	RPDLimit	Qual

Chloride	ND	0.50								
Nitrogen, Nitrite (As N)	ND	0.10								
Nitrogen, Nitrate (As N)	ND	0.10								
Sulfate	ND	0.50								

Sample ID: LCS	SampType: lcs	TestCode: EPA Method 300.0: Anions								
Client ID: LCSW	Batch ID: R101127	RunNo: 101127								
Prep Date:	Analysis Date: 11/10/2023	SeqNo: 3714136	Units: mg/L							
Analyte	Result	PQL	SPK value	SPK Ref Val	%REC	LowLimit	HighLimit	%RPD	RPDLimit	Qual

Chloride	4.8	0.50	5.000	0	96.3	90	110			
Nitrogen, Nitrite (As N)	0.98	0.10	1.000	0	98.4	90	110			
Nitrogen, Nitrate (As N)	2.5	0.10	2.500	0	100	90	110			
Sulfate	9.8	0.50	10.00	0	98.2	90	110			

Sample ID: MB	SampType: MBLK	TestCode: EPA Method 300.0: Anions								
Client ID: PBW	Batch ID: R101328	RunNo: 101328								
Prep Date:	Analysis Date: 11/20/2023	SeqNo: 3727296	Units: mg/L							
Analyte	Result	PQL	SPK value	SPK Ref Val	%REC	LowLimit	HighLimit	%RPD	RPDLimit	Qual

Chloride	ND	0.50								
----------	----	------	--	--	--	--	--	--	--	--

Sample ID: LCS	SampType: LCS	TestCode: EPA Method 300.0: Anions								
Client ID: LCSW	Batch ID: R101328	RunNo: 101328								
Prep Date:	Analysis Date: 11/20/2023	SeqNo: 3727297	Units: mg/L							
Analyte	Result	PQL	SPK value	SPK Ref Val	%REC	LowLimit	HighLimit	%RPD	RPDLimit	Qual

Chloride	4.8	0.50	5.000	0	95.6	90	110			
----------	-----	------	-------	---	------	----	-----	--	--	--

Sample ID: MB	SampType: MBLK	TestCode: EPA Method 300.0: Anions								
Client ID: PBW	Batch ID: R101328	RunNo: 101328								
Prep Date:	Analysis Date: 11/20/2023	SeqNo: 3727333	Units: mg/L							
Analyte	Result	PQL	SPK value	SPK Ref Val	%REC	LowLimit	HighLimit	%RPD	RPDLimit	Qual

Chloride	ND	0.50								
----------	----	------	--	--	--	--	--	--	--	--

Qualifiers:

- * Value exceeds Maximum Contaminant Level.
- D Sample Diluted Due to Matrix
- H Holding times for preparation or analysis exceeded
- ND Not Detected at the Reporting Limit
- PQL Practical Quantitative Limit
- S % Recovery outside of standard limits. If undiluted results may be estimated.
- B Analyte detected in the associated Method Blank
- E Above Quantitation Range/Estimated Value
- J Analyte detected below quantitation limits
- P Sample pH Not In Range
- RL Reporting Limit

QC SUMMARY REPORT

Hall Environmental Analysis Laboratory, Inc.

WO#: 2311473

05-Dec-23

Client: EA Engineering
Project: Bright Star Dairy

Sample ID: LCS	SampType: LCS	TestCode: EPA Method 300.0: Anions								
Client ID: LCSW	Batch ID: R101328	RunNo: 101328								
Prep Date:	Analysis Date: 11/20/2023	SeqNo: 3727334			Units: mg/L					
Analyte	Result	PQL	SPK value	SPK Ref Val	%REC	LowLimit	HighLimit	%RPD	RPDLimit	Qual
Chloride	4.7	0.50	5.000	0	93.9	90	110			

Qualifiers:

* Value exceeds Maximum Contaminant Level.
D Sample Diluted Due to Matrix
H Holding times for preparation or analysis exceeded
ND Not Detected at the Reporting Limit
PQL Practical Quantitative Limit
S % Recovery outside of standard limits. If undiluted results may be estimated.

B Analyte detected in the associated Method Blank
E Above Quantitation Range/Estimated Value
J Analyte detected below quantitation limits
P Sample pH Not In Range
RL Reporting Limit

QC SUMMARY REPORT

Hall Environmental Analysis Laboratory, Inc.

WO#: 2311473

05-Dec-23

Client: EA Engineering
Project: Bright Star Dairy

Sample ID: MB-78696	SampType: MBLK	TestCode: SM2540C MOD: Total Dissolved Solids								
Client ID: PBW	Batch ID: 78696	RunNo: 101111								
Prep Date: 11/9/2023	Analysis Date: 11/10/2023	SeqNo: 3712868	Units: mg/L							
Analyte	Result	PQL	SPK value	SPK Ref Val	%REC	LowLimit	HighLimit	%RPD	RPDLimit	Qual
Total Dissolved Solids	ND	50.0								

Sample ID: LCS-78696	SampType: LCS	TestCode: SM2540C MOD: Total Dissolved Solids								
Client ID: LCSW	Batch ID: 78696	RunNo: 101111								
Prep Date: 11/9/2023	Analysis Date: 11/10/2023	SeqNo: 3712869	Units: mg/L							
Analyte	Result	PQL	SPK value	SPK Ref Val	%REC	LowLimit	HighLimit	%RPD	RPDLimit	Qual
Total Dissolved Solids	1010	50.0	1000	0	101	80	120			

Qualifiers:

- * Value exceeds Maximum Contaminant Level.
- D Sample Diluted Due to Matrix
- H Holding times for preparation or analysis exceeded
- ND Not Detected at the Reporting Limit
- PQL Practical Quantitative Limit
- S % Recovery outside of standard limits. If undiluted results may be estimated.
- B Analyte detected in the associated Method Blank
- E Above Quantitation Range/Estimated Value
- J Analyte detected below quantitation limits
- P Sample pH Not In Range
- RL Reporting Limit

QC SUMMARY REPORT

Hall Environmental Analysis Laboratory, Inc.

WO#: 2311473

05-Dec-23

Client: EA Engineering
Project: Bright Star Dairy

Sample ID: LCSLL-79018	SampType: LCSLL		TestCode: EPA 351.2: TKN							
Client ID: BatchQC	Batch ID: 79018		RunNo: 101452							
Prep Date: 11/28/2023	Analysis Date: 11/28/2023		SeqNo: 3732890		Units: mg/L					
Analyte	Result	PQL	SPK value	SPK Ref Val	%REC	LowLimit	HighLimit	%RPD	RPDLimit	Qual
Nitrogen, Kjeldahl, Total	0.53	0.50	0.5000	0	106	50	150			

Sample ID: LCS-79018	SampType: LCS		TestCode: EPA 351.2: TKN							
Client ID: LCSW	Batch ID: 79018		RunNo: 101452							
Prep Date: 11/28/2023	Analysis Date: 11/28/2023		SeqNo: 3732891		Units: mg/L					
Analyte	Result	PQL	SPK value	SPK Ref Val	%REC	LowLimit	HighLimit	%RPD	RPDLimit	Qual
Nitrogen, Kjeldahl, Total	9.9	0.50	10.00	0	99.4	90	110			

Sample ID: 2311473-001AMS	SampType: MS		TestCode: EPA 351.2: TKN							
Client ID: 86/340-01	Batch ID: 79018		RunNo: 101452							
Prep Date: 11/28/2023	Analysis Date: 11/28/2023		SeqNo: 3732895		Units: mg/L					
Analyte	Result	PQL	SPK value	SPK Ref Val	%REC	LowLimit	HighLimit	%RPD	RPDLimit	Qual
Nitrogen, Kjeldahl, Total	9.9	0.50	10.00	0	98.8	90	110			

Sample ID: 2311473-001AMSD	SampType: MSD		TestCode: EPA 351.2: TKN							
Client ID: 86/340-01	Batch ID: 79018		RunNo: 101452							
Prep Date: 11/28/2023	Analysis Date: 11/28/2023		SeqNo: 3732896		Units: mg/L					
Analyte	Result	PQL	SPK value	SPK Ref Val	%REC	LowLimit	HighLimit	%RPD	RPDLimit	Qual
Nitrogen, Kjeldahl, Total	10	0.50	10.00	0	103	90	110	4.11	0	

Qualifiers:

- * Value exceeds Maximum Contaminant Level.
- D Sample Diluted Due to Matrix
- H Holding times for preparation or analysis exceeded
- ND Not Detected at the Reporting Limit
- PQL Practical Quantitative Limit
- S % Recovery outside of standard limits. If undiluted results may be estimated.
- B Analyte detected in the associated Method Blank
- E Above Quantitation Range/Estimated Value
- J Analyte detected below quantitation limits
- P Sample pH Not In Range
- RL Reporting Limit

Sample Log-In Check List

Client Name: EA Engineering Work Order Number: 2311473 RcptNo: 1

Received By: Steve McQuiston 11/9/2023 8:35:00 AM *Steve McQuiston*

Completed By: Cheyenne Cason 11/9/2023 9:28:11 AM *Cheyenne Cason*

Reviewed By: *Jan 11/9/23*

Chain of Custody

1. Is Chain of Custody complete? Yes No Not Present
2. How was the sample delivered? Client

Log In

3. Was an attempt made to cool the samples? Yes No NA
4. Were all samples received at a temperature of >0° C to 6.0°C Yes No NA
5. Sample(s) in proper container(s)? Yes No Samples not frozen
6. Sufficient sample volume for indicated test(s)? Yes No
7. Are samples (except VOA and ONG) properly preserved? Yes No
8. Was preservative added to bottles? Yes No NA
9. Received at least 1 vial with headspace <1/4" for AQ VOA? Yes No NA
10. Were any sample containers received broken? Yes No
11. Does paperwork match bottle labels? Yes No
(Note discrepancies on chain of custody)
12. Are matrices correctly identified on Chain of Custody? Yes No
13. Is it clear what analyses were requested? Yes No
14. Were all holding times able to be met? Yes No
(If no, notify customer for authorization.)

of preserved bottles checked for pH: 3
(~~2~~ or >12 unless noted)
Adjusted? NO
Checked by: *JH 11-9-23*

Special Handling (if applicable)

15. Was client notified of all discrepancies with this order? Yes No NA

Person Notified:	<input type="text"/>	Date:	<input type="text"/>
By Whom:	<input type="text"/>	Via:	<input type="checkbox"/> eMail <input type="checkbox"/> Phone <input type="checkbox"/> Fax <input type="checkbox"/> In Person
Regarding:	<input type="text"/>		
Client Instructions:	<input type="text"/>		

16. Additional remarks:

17. Cooler Information

Cooler No	Temp °C	Condition	Seal Intact	Seal No	Seal Date	Signed By
1	-0.7	Good	Not Present	Yogi		

December 05, 2023

Regina Mullen
EA Engineering
320 Gold Ave SW Suite 1210
Albuquerque, NM 87102
TEL:
FAX:

RE: Mountain View Dairy

OrderNo.: 2311568

Dear Regina Mullen:

Eurofins Environment Testing South Central, LLC received 3 sample(s) on 11/10/2023 for the analyses presented in the following report.

These were analyzed according to EPA procedures or equivalent. To access our accredited tests please go to www.hallenvironmental.com or the state specific web sites. In order to properly interpret your results, it is imperative that you review this report in its entirety. See the sample checklist and/or the Chain of Custody for information regarding the sample receipt temperature and preservation. Data qualifiers or a narrative will be provided if the sample analysis or analytical quality control parameters require a flag. When necessary, data qualifiers are provided on both the sample analysis report and the QC summary report, both sections should be reviewed. All samples are reported, as received, unless otherwise indicated. Lab measurement of analytes considered field parameters that require analysis within 15 minutes of sampling such as pH and residual chlorine are qualified as being analyzed outside of the recommended holding time.

Please do not hesitate to contact Eurofins Albuquerque for any additional information or clarifications.

ADHS Cert #AZ0682 -- NMED-DWB Cert #NM9425 -- NMED-Micro Cert #NM0901

Sincerely,



Andy Freeman
Laboratory Manager
4901 Hawkins NE
Albuquerque, NM 87109

Hall Environmental Analysis Laboratory, Inc.

Analytical Report

Lab Order 2311568

Date Reported: 12/5/2023

CLIENT: EA Engineering

Client Sample ID: 70-04

Project: Mountain View Dairy

Collection Date: 11/9/2023 10:48:00 AM

Lab ID: 2311568-001

Matrix: GROUNDWA

Received Date: 11/10/2023 8:40:00 AM

Analyses	Result	RL	Qual	Units	DF	Date Analyzed	Batch
EPA METHOD 300.0: ANIONS							Analyst: JMT
Chloride	610	50	*	mg/L	100	11/10/2023 12:39:21 PM	R101127
Nitrogen, Nitrate (As N)	17	1.0	*	mg/L	10	11/10/2023 12:26:29 PM	R101127
Sulfate	690	50	*	mg/L	100	11/10/2023 12:39:21 PM	R101127
SM2540C MOD: TOTAL DISSOLVED SOLIDS							Analyst: MCA
Total Dissolved Solids	3080	250	*D	mg/L	1	11/14/2023 2:34:00 PM	78758
EPA 351.2: TKN							Analyst: DML
Nitrogen, Kjeldahl, Total	ND	0.50		mg/L	1	11/30/2023 2:54:58 PM	79052

Refer to the QC Summary report and sample login checklist for flagged QC data and preservation information.

Qualifiers:	*	Value exceeds Maximum Contaminant Level.	B	Analyte detected in the associated Method Blank
	D	Sample Diluted Due to Matrix	E	Above Quantitation Range/Estimated Value
	H	Holding times for preparation or analysis exceeded	J	Analyte detected below quantitation limits
	ND	Not Detected at the Reporting Limit	P	Sample pH Not In Range
	PQL	Practical Quantitative Limit	RL	Reporting Limit
	S	% Recovery outside of standard limits. If undiluted results may be estimated.		

Hall Environmental Analysis Laboratory, Inc.

Analytical Report

Lab Order 2311568

Date Reported: 12/5/2023

CLIENT: EA Engineering

Client Sample ID: 70-01

Project: Mountain View Dairy

Collection Date: 11/9/2023 1:53:00 PM

Lab ID: 2311568-002

Matrix: GROUNDWA

Received Date: 11/10/2023 8:40:00 AM

Analyses	Result	RL	Qual	Units	DF	Date Analyzed	Batch
EPA METHOD 300.0: ANIONS							Analyst: JMT
Chloride	680	50	*	mg/L	100	11/10/2023 1:05:05 PM	R101127
Nitrogen, Nitrate (As N)	14	1.0	*	mg/L	10	11/10/2023 12:52:13 PM	R101127
Sulfate	780	50	*	mg/L	100	11/10/2023 1:05:05 PM	R101127
SM2540C MOD: TOTAL DISSOLVED SOLIDS							Analyst: MCA
Total Dissolved Solids	3180	50.0	*	mg/L	1	11/14/2023 2:34:00 PM	78758
EPA 351.2: TKN							Analyst: DML
Nitrogen, Kjeldahl, Total	0.71	0.50		mg/L	1	11/30/2023 2:56:28 PM	79052

Refer to the QC Summary report and sample login checklist for flagged QC data and preservation information.

Qualifiers:	*	Value exceeds Maximum Contaminant Level.	B	Analyte detected in the associated Method Blank
	D	Sample Diluted Due to Matrix	E	Above Quantitation Range/Estimated Value
	H	Holding times for preparation or analysis exceeded	J	Analyte detected below quantitation limits
	ND	Not Detected at the Reporting Limit	P	Sample pH Not In Range
	PQL	Practical Quantitative Limit	RL	Reporting Limit
	S	% Recovery outside of standard limits. If undiluted results may be estimated.		

Hall Environmental Analysis Laboratory, Inc.

Analytical Report

Lab Order 2311568

Date Reported: 12/5/2023

CLIENT: EA Engineering

Client Sample ID: 70-03

Project: Mountain View Dairy

Collection Date: 11/9/2023 4:00:00 PM

Lab ID: 2311568-003

Matrix: GROUNDWA

Received Date: 11/10/2023 8:40:00 AM

Analyses	Result	RL	Qual	Units	DF	Date Analyzed	Batch
EPA METHOD 300.0: ANIONS							Analyst: JMT
Chloride	1700	50	*	mg/L	100	11/10/2023 1:30:49 PM	R101127
Nitrogen, Nitrate (As N)	38	1.0	*	mg/L	10	11/10/2023 1:17:57 PM	R101127
Sulfate	870	50	*	mg/L	100	11/10/2023 1:30:49 PM	R101127
SM2540C MOD: TOTAL DISSOLVED SOLIDS							Analyst: MCA
Total Dissolved Solids	4520	250	*D	mg/L	1	11/14/2023 2:34:00 PM	78758
EPA 351.2: TKN							Analyst: DML
Nitrogen, Kjeldahl, Total	1.1	0.50		mg/L	1	11/30/2023 2:57:58 PM	79052

Refer to the QC Summary report and sample login checklist for flagged QC data and preservation information.

Qualifiers:	*	Value exceeds Maximum Contaminant Level.	B	Analyte detected in the associated Method Blank
	D	Sample Diluted Due to Matrix	E	Above Quantitation Range/Estimated Value
	H	Holding times for preparation or analysis exceeded	J	Analyte detected below quantitation limits
	ND	Not Detected at the Reporting Limit	P	Sample pH Not In Range
	PQL	Practical Quantitative Limit	RL	Reporting Limit
	S	% Recovery outside of standard limits. If undiluted results may be estimated.		

QC SUMMARY REPORT

Hall Environmental Analysis Laboratory, Inc.

WO#: 2311568

05-Dec-23

Client: EA Engineering
Project: Mountain View Dairy

Sample ID: MB	SampType: mblk	TestCode: EPA Method 300.0: Anions
Client ID: PBW	Batch ID: R101127	RunNo: 101127
Prep Date:	Analysis Date: 11/10/2023	SeqNo: 3714135 Units: mg/L

Analyte	Result	PQL	SPK value	SPK Ref Val	%REC	LowLimit	HighLimit	%RPD	RPDLimit	Qual
Chloride	ND	0.50								
Nitrogen, Nitrate (As N)	ND	0.10								
Sulfate	ND	0.50								

Sample ID: LCS	SampType: lcs	TestCode: EPA Method 300.0: Anions
Client ID: LCSW	Batch ID: R101127	RunNo: 101127
Prep Date:	Analysis Date: 11/10/2023	SeqNo: 3714136 Units: mg/L

Analyte	Result	PQL	SPK value	SPK Ref Val	%REC	LowLimit	HighLimit	%RPD	RPDLimit	Qual
Chloride	4.8	0.50	5.000	0	96.3	90	110			
Nitrogen, Nitrate (As N)	2.5	0.10	2.500	0	100	90	110			
Sulfate	9.8	0.50	10.00	0	98.2	90	110			

Qualifiers:

- | | |
|---|---|
| * Value exceeds Maximum Contaminant Level. | B Analyte detected in the associated Method Blank |
| D Sample Diluted Due to Matrix | E Above Quantitation Range/Estimated Value |
| H Holding times for preparation or analysis exceeded | J Analyte detected below quantitation limits |
| ND Not Detected at the Reporting Limit | P Sample pH Not In Range |
| PQL Practical Quantitative Limit | RL Reporting Limit |
| S % Recovery outside of standard limits. If undiluted results may be estimated. | |

QC SUMMARY REPORT

Hall Environmental Analysis Laboratory, Inc.

WO#: 2311568

05-Dec-23

Client: EA Engineering
Project: Mountain View Dairy

Sample ID: MB-78758	SampType: MBLK	TestCode: SM2540C MOD: Total Dissolved Solids								
Client ID: PBW	Batch ID: 78758	RunNo: 101166								
Prep Date: 11/13/2023	Analysis Date: 11/14/2023	SeqNo: 3716995	Units: mg/L							
Analyte	Result	PQL	SPK value	SPK Ref Val	%REC	LowLimit	HighLimit	%RPD	RPDLimit	Qual
Total Dissolved Solids	ND	50.0								

Sample ID: LCS-78758	SampType: LCS	TestCode: SM2540C MOD: Total Dissolved Solids								
Client ID: LCSW	Batch ID: 78758	RunNo: 101166								
Prep Date: 11/13/2023	Analysis Date: 11/14/2023	SeqNo: 3716996	Units: mg/L							
Analyte	Result	PQL	SPK value	SPK Ref Val	%REC	LowLimit	HighLimit	%RPD	RPDLimit	Qual
Total Dissolved Solids	1020	50.0	1000	0	102	80	120			

Qualifiers:

- | | |
|---|---|
| * Value exceeds Maximum Contaminant Level. | B Analyte detected in the associated Method Blank |
| D Sample Diluted Due to Matrix | E Above Quantitation Range/Estimated Value |
| H Holding times for preparation or analysis exceeded | J Analyte detected below quantitation limits |
| ND Not Detected at the Reporting Limit | P Sample pH Not In Range |
| PQL Practical Quantitative Limit | RL Reporting Limit |
| S % Recovery outside of standard limits. If undiluted results may be estimated. | |

QC SUMMARY REPORT

Hall Environmental Analysis Laboratory, Inc.

WO#: 2311568

05-Dec-23

Client: EA Engineering
Project: Mountain View Dairy

Sample ID: MB-79052	SampType: MBLK	TestCode: EPA 351.2: TKN								
Client ID: PBW	Batch ID: 79052	RunNo: 101514								
Prep Date: 11/29/2023	Analysis Date: 11/30/2023	SeqNo: 3736598	Units: mg/L							
Analyte	Result	PQL	SPK value	SPK Ref Val	%REC	LowLimit	HighLimit	%RPD	RPDLimit	Qual
Nitrogen, Kjeldahl, Total	ND	0.50								

Sample ID: LCSLL-79052	SampType: LCSLL	TestCode: EPA 351.2: TKN								
Client ID: BatchQC	Batch ID: 79052	RunNo: 101514								
Prep Date: 11/29/2023	Analysis Date: 11/30/2023	SeqNo: 3736599	Units: mg/L							
Analyte	Result	PQL	SPK value	SPK Ref Val	%REC	LowLimit	HighLimit	%RPD	RPDLimit	Qual
Nitrogen, Kjeldahl, Total	0.48	0	0.5000	0	96.3	50	150			

Sample ID: LCS-79052	SampType: LCS	TestCode: EPA 351.2: TKN								
Client ID: LCSW	Batch ID: 79052	RunNo: 101514								
Prep Date: 11/29/2023	Analysis Date: 11/30/2023	SeqNo: 3736600	Units: mg/L							
Analyte	Result	PQL	SPK value	SPK Ref Val	%REC	LowLimit	HighLimit	%RPD	RPDLimit	Qual
Nitrogen, Kjeldahl, Total	11	0.50	10.00	0	106	90	110			

Qualifiers:

- | | |
|---|---|
| * Value exceeds Maximum Contaminant Level. | B Analyte detected in the associated Method Blank |
| D Sample Diluted Due to Matrix | E Above Quantitation Range/Estimated Value |
| H Holding times for preparation or analysis exceeded | J Analyte detected below quantitation limits |
| ND Not Detected at the Reporting Limit | P Sample pH Not In Range |
| PQL Practical Quantitative Limit | RL Reporting Limit |
| S % Recovery outside of standard limits. If undiluted results may be estimated. | |

Client Name: **EA Engineering** Work Order Number: **2311568** RcptNo: **1**

Received By: **Joseph Alderette** 11/10/2023 8:40:00 AM

Completed By: **Desiree Dominguez** 11/10/2023 9:37:41 AM

Reviewed By: *yn 11/10/23*

J
DD

Chain of Custody

1. Is Chain of Custody complete? Yes No Not Present
2. How was the sample delivered? FedEx

Log In

3. Was an attempt made to cool the samples? Yes No NA
4. Were all samples received at a temperature of >0° C to 6.0°C Yes No NA
5. Sample(s) in proper container(s)? Yes No
6. Sufficient sample volume for indicated test(s)? Yes No
7. Are samples (except VOA and ONG) properly preserved? Yes No
8. Was preservative added to bottles? Yes No NA
9. Received at least 1 vial with headspace <1/4" for AQ VOA? Yes No NA
10. Were any sample containers received broken? Yes No
11. Does paperwork match bottle labels? Yes No
 (Note discrepancies on chain of custody)
12. Are matrices correctly identified on Chain of Custody? Yes No
13. Is it clear what analyses were requested? Yes No
14. Were all holding times able to be met? Yes No
 (If no, notify customer for authorization.)

of preserved bottles checked for pH: 3
 (2 or >12 unless noted)
 Adjusted? NO
 Checked by: *J 11-10-23*

Special Handling (if applicable)

15. Was client notified of all discrepancies with this order? Yes No NA

Person Notified:	<input type="text"/>	Date:	<input type="text"/>
By Whom:	<input type="text"/>	Via:	<input type="checkbox"/> eMail <input type="checkbox"/> Phone <input type="checkbox"/> Fax <input type="checkbox"/> In Person
Regarding:	<input type="text"/>		
Client Instructions:	<input type="text"/>		

16. Additional remarks:

17. Cooler Information

Cooler No	Temp °C	Condition	Seal Intact	Seal No	Seal Date	Signed By
1	0.5	Good	Not Present	Yogi		

December 20, 2023

Regina Mullen
EA Engineering
320 Gold Ave SW Suite 1210
Albuquerque, NM 87102
TEL:
FAX:

RE: Dominguez Dairy 2

OrderNo.: 2311837

Dear Regina Mullen:

Eurofins Environment Testing South Central, LLC received 1 sample(s) on 11/16/2023 for the analyses presented in the following report.

These were analyzed according to EPA procedures or equivalent. To access our accredited tests please go to www.hallenvironmental.com or the state specific web sites. In order to properly interpret your results, it is imperative that you review this report in its entirety. See the sample checklist and/or the Chain of Custody for information regarding the sample receipt temperature and preservation. Data qualifiers or a narrative will be provided if the sample analysis or analytical quality control parameters require a flag. When necessary, data qualifiers are provided on both the sample analysis report and the QC summary report, both sections should be reviewed. All samples are reported, as received, unless otherwise indicated. Lab measurement of analytes considered field parameters that require analysis within 15 minutes of sampling such as pH and residual chlorine are qualified as being analyzed outside of the recommended holding time.

Please do not hesitate to contact Eurofins Albuquerque for any additional information or clarifications.

ADHS Cert #AZ0682 -- NMED-DWB Cert #NM9425 -- NMED-Micro Cert #NM0901

Sincerely,



Andy Freeman
Laboratory Manager
4901 Hawkins NE
Albuquerque, NM 87109

Hall Environmental Analysis Laboratory, Inc.

Analytical Report

Lab Order 2311837

Date Reported: 12/20/2023

CLIENT: EA Engineering

Client Sample ID: 42-11

Project: Dominguez Dairy 2

Collection Date: 11/15/2023 2:30:00 PM

Lab ID: 2311837-001

Matrix: GROUNDWA

Received Date: 11/16/2023 8:45:00 AM

Analyses	Result	RL	Qual	Units	DF	Date Analyzed	Batch
EPA METHOD 300.0: ANIONS							Analyst: SNS
Chloride	310	50	*	mg/L	100	11/16/2023 6:03:17 PM	R101261
Nitrogen, Nitrite (As N)	ND	1.0		mg/L	10	11/16/2023 5:24:42 PM	R101261
Nitrogen, Nitrate (As N)	ND	1.0		mg/L	10	11/16/2023 5:24:42 PM	R101261
SM2540C MOD: TOTAL DISSOLVED SOLIDS							Analyst: MCA
Total Dissolved Solids	1120	100	*D	mg/L	1	11/17/2023 1:42:00 PM	78856
EPA 351.2: TKN							Analyst: DML
Nitrogen, Kjeldahl, Total	ND	0.50		mg/L	1	12/13/2023 3:44:44 PM	79310

Refer to the QC Summary report and sample login checklist for flagged QC data and preservation information.

Qualifiers:	*	Value exceeds Maximum Contaminant Level.	B	Analyte detected in the associated Method Blank
	D	Sample Diluted Due to Matrix	E	Above Quantitation Range/Estimated Value
	H	Holding times for preparation or analysis exceeded	J	Analyte detected below quantitation limits
	ND	Not Detected at the Reporting Limit	P	Sample pH Not In Range
	PQL	Practical Quantitative Limit	RL	Reporting Limit
	S	% Recovery outside of standard limits. If undiluted results may be estimated.		

QC SUMMARY REPORT

Hall Environmental Analysis Laboratory, Inc.

WO#: 2311837

20-Dec-23

Client: EA Engineering
Project: Dominguez Dairy 2

Sample ID: MB	SampType: MBLK	TestCode: EPA Method 300.0: Anions								
Client ID: PBW	Batch ID: R101261	RunNo: 101261								
Prep Date:	Analysis Date: 11/16/2023	SeqNo: 3723172	Units: mg/L							
Analyte	Result	PQL	SPK value	SPK Ref Val	%REC	LowLimit	HighLimit	%RPD	RPDLimit	Qual

Chloride	ND	0.50								
Nitrogen, Nitrite (As N)	ND	0.10								
Nitrogen, Nitrate (As N)	ND	0.10								

Sample ID: LCS	SampType: LCS	TestCode: EPA Method 300.0: Anions								
Client ID: LCSW	Batch ID: R101261	RunNo: 101261								
Prep Date:	Analysis Date: 11/16/2023	SeqNo: 3723173	Units: mg/L							
Analyte	Result	PQL	SPK value	SPK Ref Val	%REC	LowLimit	HighLimit	%RPD	RPDLimit	Qual

Chloride	4.8	0.50	5.000	0	96.2	90	110			
Nitrogen, Nitrite (As N)	0.98	0.10	1.000	0	98.2	90	110			
Nitrogen, Nitrate (As N)	2.5	0.10	2.500	0	100	90	110			

Sample ID: MB	SampType: MBLK	TestCode: EPA Method 300.0: Anions								
Client ID: PBW	Batch ID: R101261	RunNo: 101261								
Prep Date:	Analysis Date: 11/16/2023	SeqNo: 3723201	Units: mg/L							
Analyte	Result	PQL	SPK value	SPK Ref Val	%REC	LowLimit	HighLimit	%RPD	RPDLimit	Qual

Chloride	ND	0.50								
Nitrogen, Nitrite (As N)	ND	0.10								
Nitrogen, Nitrate (As N)	ND	0.10								

Sample ID: LCS	SampType: LCS	TestCode: EPA Method 300.0: Anions								
Client ID: LCSW	Batch ID: R101261	RunNo: 101261								
Prep Date:	Analysis Date: 11/16/2023	SeqNo: 3723202	Units: mg/L							
Analyte	Result	PQL	SPK value	SPK Ref Val	%REC	LowLimit	HighLimit	%RPD	RPDLimit	Qual

Chloride	4.9	0.50	5.000	0	97.8	90	110			
Nitrogen, Nitrite (As N)	1.0	0.10	1.000	0	99.5	90	110			
Nitrogen, Nitrate (As N)	2.5	0.10	2.500	0	102	90	110			

Sample ID: 2311837-001AMS	SampType: MS	TestCode: EPA Method 300.0: Anions								
Client ID: 42-11	Batch ID: R101261	RunNo: 101261								
Prep Date:	Analysis Date: 11/16/2023	SeqNo: 3723214	Units: mg/L							
Analyte	Result	PQL	SPK value	SPK Ref Val	%REC	LowLimit	HighLimit	%RPD	RPDLimit	Qual

Nitrogen, Nitrite (As N)	9.6	1.0	10.00	0	96.1	80	120			
Nitrogen, Nitrate (As N)	25	1.0	25.00	0.4349	99.2	80	120			

Qualifiers:

- * Value exceeds Maximum Contaminant Level.
- D Sample Diluted Due to Matrix
- H Holding times for preparation or analysis exceeded
- ND Not Detected at the Reporting Limit
- PQL Practical Quantitative Limit
- S % Recovery outside of standard limits. If undiluted results may be estimated.
- B Analyte detected in the associated Method Blank
- E Above Quantitation Range/Estimated Value
- J Analyte detected below quantitation limits
- P Sample pH Not In Range
- RL Reporting Limit

QC SUMMARY REPORT

Hall Environmental Analysis Laboratory, Inc.

WO#: 2311837

20-Dec-23

Client: EA Engineering
Project: Dominguez Dairy 2

Sample ID: 2311837-001AMSD	SampType: MSD	TestCode: EPA Method 300.0: Anions								
Client ID: 42-11	Batch ID: R101261	RunNo: 101261								
Prep Date:	Analysis Date: 11/16/2023	SeqNo: 3723215			Units: mg/L					
Analyte	Result	PQL	SPK value	SPK Ref Val	%REC	LowLimit	HighLimit	%RPD	RPDLimit	Qual
Nitrogen, Nitrite (As N)	9.6	1.0	10.00	0	96.0	80	120	0.0423	20	
Nitrogen, Nitrate (As N)	25	1.0	25.00	0.4349	98.9	80	120	0.319	20	

Qualifiers:

- | | |
|---|---|
| * Value exceeds Maximum Contaminant Level. | B Analyte detected in the associated Method Blank |
| D Sample Diluted Due to Matrix | E Above Quantitation Range/Estimated Value |
| H Holding times for preparation or analysis exceeded | J Analyte detected below quantitation limits |
| ND Not Detected at the Reporting Limit | P Sample pH Not In Range |
| PQL Practical Quantitative Limit | RL Reporting Limit |
| S % Recovery outside of standard limits. If undiluted results may be estimated. | |

QC SUMMARY REPORT

Hall Environmental Analysis Laboratory, Inc.

WO#: 2311837

20-Dec-23

Client: EA Engineering
Project: Dominguez Dairy 2

Sample ID: MB-78856	SampType: MBLK	TestCode: SM2540C MOD: Total Dissolved Solids								
Client ID: PBW	Batch ID: 78856	RunNo: 101274								
Prep Date: 11/16/2023	Analysis Date: 11/17/2023	SeqNo: 3724511	Units: mg/L							
Analyte	Result	PQL	SPK value	SPK Ref Val	%REC	LowLimit	HighLimit	%RPD	RPDLimit	Qual
Total Dissolved Solids	ND	50.0								

Sample ID: LCS-78856	SampType: LCS	TestCode: SM2540C MOD: Total Dissolved Solids								
Client ID: LCSW	Batch ID: 78856	RunNo: 101274								
Prep Date: 11/16/2023	Analysis Date: 11/17/2023	SeqNo: 3724512	Units: mg/L							
Analyte	Result	PQL	SPK value	SPK Ref Val	%REC	LowLimit	HighLimit	%RPD	RPDLimit	Qual
Total Dissolved Solids	1010	50.0	1000	0	101	80	120			

Qualifiers:

- * Value exceeds Maximum Contaminant Level.
- D Sample Diluted Due to Matrix
- H Holding times for preparation or analysis exceeded
- ND Not Detected at the Reporting Limit
- PQL Practical Quantitative Limit
- S % Recovery outside of standard limits. If undiluted results may be estimated.
- B Analyte detected in the associated Method Blank
- E Above Quantitation Range/Estimated Value
- J Analyte detected below quantitation limits
- P Sample pH Not In Range
- RL Reporting Limit

QC SUMMARY REPORT

Hall Environmental Analysis Laboratory, Inc.

WO#: 2311837

20-Dec-23

Client: EA Engineering
Project: Dominguez Dairy 2

Sample ID: MB-79310	SampType: MBLK	TestCode: EPA 351.2: TKN								
Client ID: PBW	Batch ID: 79310	RunNo: 101810								
Prep Date: 12/12/2023	Analysis Date: 12/13/2023	SeqNo: 3753064	Units: mg/L							
Analyte	Result	PQL	SPK value	SPK Ref Val	%REC	LowLimit	HighLimit	%RPD	RPDLimit	Qual
Nitrogen, Kjeldahl, Total	ND	0.50								

Sample ID: LCSLL-79310	SampType: LCSLL	TestCode: EPA 351.2: TKN								
Client ID: BatchQC	Batch ID: 79310	RunNo: 101810								
Prep Date: 12/12/2023	Analysis Date: 12/13/2023	SeqNo: 3753065	Units: mg/L							
Analyte	Result	PQL	SPK value	SPK Ref Val	%REC	LowLimit	HighLimit	%RPD	RPDLimit	Qual
Nitrogen, Kjeldahl, Total	0.47	0	0.5000	0	93.8	50	150			

Sample ID: LCS-79310	SampType: LCS	TestCode: EPA 351.2: TKN								
Client ID: LCSW	Batch ID: 79310	RunNo: 101810								
Prep Date: 12/12/2023	Analysis Date: 12/13/2023	SeqNo: 3753066	Units: mg/L							
Analyte	Result	PQL	SPK value	SPK Ref Val	%REC	LowLimit	HighLimit	%RPD	RPDLimit	Qual
Nitrogen, Kjeldahl, Total	10	0.50	10.00	0	101	90	110			

Sample ID: 2311837-001AMS	SampType: MS	TestCode: EPA 351.2: TKN								
Client ID: 42-11	Batch ID: 79310	RunNo: 101810								
Prep Date: 12/12/2023	Analysis Date: 12/13/2023	SeqNo: 3753082	Units: mg/L							
Analyte	Result	PQL	SPK value	SPK Ref Val	%REC	LowLimit	HighLimit	%RPD	RPDLimit	Qual
Nitrogen, Kjeldahl, Total	10	0.50	10.00	0	101	90	110			

Sample ID: 2311837-001AMSD	SampType: MSD	TestCode: EPA 351.2: TKN								
Client ID: 42-11	Batch ID: 79310	RunNo: 101810								
Prep Date: 12/12/2023	Analysis Date: 12/13/2023	SeqNo: 3753083	Units: mg/L							
Analyte	Result	PQL	SPK value	SPK Ref Val	%REC	LowLimit	HighLimit	%RPD	RPDLimit	Qual
Nitrogen, Kjeldahl, Total	10	0.50	10.00	0	102	90	110	0.813	0	

Qualifiers:

- * Value exceeds Maximum Contaminant Level.
- D Sample Diluted Due to Matrix
- H Holding times for preparation or analysis exceeded
- ND Not Detected at the Reporting Limit
- PQL Practical Quantitative Limit
- S % Recovery outside of standard limits. If undiluted results may be estimated.
- B Analyte detected in the associated Method Blank
- E Above Quantitation Range/Estimated Value
- J Analyte detected below quantitation limits
- P Sample pH Not In Range
- RL Reporting Limit

Sample Log-In Check List

Client Name: EA Engineering Work Order Number: 2311837 RcptNo: 1

Received By: Joseph Alderette 11/16/2023 8:45:00 AM

Completed By: Desiree Dominguez 11/16/2023 10:18:28 AM

Reviewed By: *722 11/16/23*

[Handwritten initials]

Chain of Custody

1. Is Chain of Custody complete? Yes No Not Present
2. How was the sample delivered? FedEx

Log In

3. Was an attempt made to cool the samples? Yes No NA
4. Were all samples received at a temperature of >0° C to 6.0°C Yes No NA
- Samples were collected the same day and chilled.
5. Sample(s) in proper container(s)? Yes No
6. Sufficient sample volume for indicated test(s)? Yes No
7. Are samples (except VOA and ONG) properly preserved? Yes No
8. Was preservative added to bottles? Yes No NA
9. Received at least 1 vial with headspace <1/4" for AQ VOA? Yes No NA
10. Were any sample containers received broken? Yes No
11. Does paperwork match bottle labels? Yes No
 (Note discrepancies on chain of custody)
12. Are matrices correctly identified on Chain of Custody? Yes No
13. Is it clear what analyses were requested? Yes No
14. Were all holding times able to be met? Yes No
 (If no, notify customer for authorization.)

of preserved bottles checked for pH: 1
 (<2 or >12 unless noted)
 Adjusted? NO
 Checked by: SCM 11/16/23

Special Handling (if applicable)

15. Was client notified of all discrepancies with this order? Yes No NA

Person Notified:	_____	Date:	_____
By Whom:	_____	Via:	<input type="checkbox"/> eMail <input type="checkbox"/> Phone <input type="checkbox"/> Fax <input type="checkbox"/> In Person
Regarding:	_____		
Client Instructions:	_____		

16. Additional remarks:

17. Cooler Information

Cooler No	Temp °C	Condition	Seal Intact	Seal No	Seal Date	Signed By
1	-2.8	Good	Not Present	Yogi		

December 20, 2023

Regina Mullen
EA Engineering
320 Gold Ave SW Suite 1210
Albuquerque, NM 87102
TEL:
FAX:

RE: Dominguez Dairy 1

OrderNo.: 2311844

Dear Regina Mullen:

Eurofins Environment Testing South Central, LLC received 2 sample(s) on 11/16/2023 for the analyses presented in the following report.

These were analyzed according to EPA procedures or equivalent. To access our accredited tests please go to www.hallenvironmental.com or the state specific web sites. In order to properly interpret your results, it is imperative that you review this report in its entirety. See the sample checklist and/or the Chain of Custody for information regarding the sample receipt temperature and preservation. Data qualifiers or a narrative will be provided if the sample analysis or analytical quality control parameters require a flag. When necessary, data qualifiers are provided on both the sample analysis report and the QC summary report, both sections should be reviewed. All samples are reported, as received, unless otherwise indicated. Lab measurement of analytes considered field parameters that require analysis within 15 minutes of sampling such as pH and residual chlorine are qualified as being analyzed outside of the recommended holding time.

Please do not hesitate to contact Eurofins Albuquerque for any additional information or clarifications.

ADHS Cert #AZ0682 -- NMED-DWB Cert #NM9425 -- NMED-Micro Cert #NM0901

Sincerely,



Andy Freeman
Laboratory Manager
4901 Hawkins NE
Albuquerque, NM 87109

Hall Environmental Analysis Laboratory, Inc.

Analytical Report

Lab Order 2311844

Date Reported: 12/20/2023

CLIENT: EA Engineering

Client Sample ID: 624-09

Project: Dominguez Dairy 1

Collection Date: 11/15/2023 10:30:00 AM

Lab ID: 2311844-001

Matrix: GROUNDWA

Received Date: 11/16/2023 8:45:00 AM

Analyses	Result	RL	Qual	Units	DF	Date Analyzed	Batch
EPA METHOD 300.0: ANIONS							Analyst: JMT
Chloride	330	50	*	mg/L	100	11/16/2023 10:49:59 PM	A101258
Nitrogen, Nitrite (As N)	ND	1.0		mg/L	10	11/16/2023 10:37:08 PM	A101258
Nitrogen, Nitrate (As N)	1.8	1.0		mg/L	10	11/16/2023 10:37:08 PM	A101258
SM2540C MOD: TOTAL DISSOLVED SOLIDS							Analyst: KS
Total Dissolved Solids	1750	250	*D	mg/L	1	11/20/2023 5:17:00 PM	78870
EPA 351.2: TKN							Analyst: DML
Nitrogen, Kjeldahl, Total	0.73	0.50		mg/L	1	12/13/2023 3:49:15 PM	79310

Refer to the QC Summary report and sample login checklist for flagged QC data and preservation information.

Qualifiers:	*	Value exceeds Maximum Contaminant Level.	B	Analyte detected in the associated Method Blank
	D	Sample Diluted Due to Matrix	E	Above Quantitation Range/Estimated Value
	H	Holding times for preparation or analysis exceeded	J	Analyte detected below quantitation limits
	ND	Not Detected at the Reporting Limit	P	Sample pH Not In Range
	PQL	Practical Quantitative Limit	RL	Reporting Limit
	S	% Recovery outside of standard limits. If undiluted results may be estimated.		

Hall Environmental Analysis Laboratory, Inc.

Analytical Report

Lab Order 2311844

Date Reported: 12/20/2023

CLIENT: EA Engineering

Client Sample ID: 624-10

Project: Dominguez Dairy 1

Collection Date: 11/15/2023 11:52:00 AM

Lab ID: 2311844-002

Matrix: GROUNDWA

Received Date: 11/16/2023 8:45:00 AM

Analyses	Result	RL	Qual	Units	DF	Date Analyzed	Batch
EPA METHOD 300.0: ANIONS							Analyst: JMT
Chloride	570	50	*	mg/L	100	11/16/2023 11:15:42 PM	A101258
Nitrogen, Nitrite (As N)	ND	1.0		mg/L	10	11/16/2023 11:02:51 PM	A101258
Nitrogen, Nitrate (As N)	ND	1.0		mg/L	10	11/16/2023 11:02:51 PM	A101258
SM2540C MOD: TOTAL DISSOLVED SOLIDS							Analyst: KS
Total Dissolved Solids	2870	250	*D	mg/L	1	11/20/2023 5:17:00 PM	78870
EPA 351.2: TKN							Analyst: DML
Nitrogen, Kjeldahl, Total	0.79	0.50		mg/L	1	12/13/2023 3:50:45 PM	79310

Refer to the QC Summary report and sample login checklist for flagged QC data and preservation information.

Qualifiers:	*	Value exceeds Maximum Contaminant Level.	B	Analyte detected in the associated Method Blank
	D	Sample Diluted Due to Matrix	E	Above Quantitation Range/Estimated Value
	H	Holding times for preparation or analysis exceeded	J	Analyte detected below quantitation limits
	ND	Not Detected at the Reporting Limit	P	Sample pH Not In Range
	PQL	Practical Quantitative Limit	RL	Reporting Limit
	S	% Recovery outside of standard limits. If undiluted results may be estimated.		

QC SUMMARY REPORT

Hall Environmental Analysis Laboratory, Inc.

WO#: 2311844

20-Dec-23

Client: EA Engineering
Project: Dominguez Dairy 1

Sample ID: MB	SampType: mblk	TestCode: EPA Method 300.0: Anions								
Client ID: PBW	Batch ID: A101258	RunNo: 101258								
Prep Date:	Analysis Date: 11/16/2023	SeqNo: 3723095	Units: mg/L							
Analyte	Result	PQL	SPK value	SPK Ref Val	%REC	LowLimit	HighLimit	%RPD	RPDLimit	Qual
Chloride	ND	0.50								
Nitrogen, Nitrite (As N)	ND	0.10								
Nitrogen, Nitrate (As N)	ND	0.10								

Sample ID: LCS	SampType: ics	TestCode: EPA Method 300.0: Anions								
Client ID: LCSW	Batch ID: A101258	RunNo: 101258								
Prep Date:	Analysis Date: 11/16/2023	SeqNo: 3723096	Units: mg/L							
Analyte	Result	PQL	SPK value	SPK Ref Val	%REC	LowLimit	HighLimit	%RPD	RPDLimit	Qual
Chloride	4.9	0.50	5.000	0	98.8	90	110			
Nitrogen, Nitrite (As N)	1.0	0.10	1.000	0	100	90	110			
Nitrogen, Nitrate (As N)	2.6	0.10	2.500	0	102	90	110			

Qualifiers:

- * Value exceeds Maximum Contaminant Level.
- D Sample Diluted Due to Matrix
- H Holding times for preparation or analysis exceeded
- ND Not Detected at the Reporting Limit
- PQL Practical Quantitative Limit
- S % Recovery outside of standard limits. If undiluted results may be estimated.
- B Analyte detected in the associated Method Blank
- E Above Quantitation Range/Estimated Value
- J Analyte detected below quantitation limits
- P Sample pH Not In Range
- RL Reporting Limit

QC SUMMARY REPORT

Hall Environmental Analysis Laboratory, Inc.

WO#: 2311844

20-Dec-23

Client: EA Engineering
Project: Dominguez Dairy 1

Sample ID: MB-78870	SampType: MBLK	TestCode: SM2540C MOD: Total Dissolved Solids								
Client ID: PBW	Batch ID: 78870	RunNo: 101324								
Prep Date: 11/17/2023	Analysis Date: 11/20/2023	SeqNo: 3727065	Units: mg/L							
Analyte	Result	PQL	SPK value	SPK Ref Val	%REC	LowLimit	HighLimit	%RPD	RPDLimit	Qual
Total Dissolved Solids	ND	50.0								

Sample ID: LCS-78870	SampType: LCS	TestCode: SM2540C MOD: Total Dissolved Solids								
Client ID: LCSW	Batch ID: 78870	RunNo: 101324								
Prep Date: 11/17/2023	Analysis Date: 11/20/2023	SeqNo: 3727066	Units: mg/L							
Analyte	Result	PQL	SPK value	SPK Ref Val	%REC	LowLimit	HighLimit	%RPD	RPDLimit	Qual
Total Dissolved Solids	1030	50.0	1000	0	103	80	120			

Qualifiers:

- * Value exceeds Maximum Contaminant Level.
- D Sample Diluted Due to Matrix
- H Holding times for preparation or analysis exceeded
- ND Not Detected at the Reporting Limit
- PQL Practical Quantitative Limit
- S % Recovery outside of standard limits. If undiluted results may be estimated.
- B Analyte detected in the associated Method Blank
- E Above Quantitation Range/Estimated Value
- J Analyte detected below quantitation limits
- P Sample pH Not In Range
- RL Reporting Limit

QC SUMMARY REPORT

Hall Environmental Analysis Laboratory, Inc.

WO#: 2311844

20-Dec-23

Client: EA Engineering
Project: Dominguez Dairy 1

Sample ID: MB-79310	SampType: MBLK	TestCode: EPA 351.2: TKN								
Client ID: PBW	Batch ID: 79310	RunNo: 101810								
Prep Date: 12/12/2023	Analysis Date: 12/13/2023	SeqNo: 3753064	Units: mg/L							
Analyte	Result	PQL	SPK value	SPK Ref Val	%REC	LowLimit	HighLimit	%RPD	RPDLimit	Qual
Nitrogen, Kjeldahl, Total	ND	0.50								

Sample ID: LCSLL-79310	SampType: LCSLL	TestCode: EPA 351.2: TKN								
Client ID: BatchQC	Batch ID: 79310	RunNo: 101810								
Prep Date: 12/12/2023	Analysis Date: 12/13/2023	SeqNo: 3753065	Units: mg/L							
Analyte	Result	PQL	SPK value	SPK Ref Val	%REC	LowLimit	HighLimit	%RPD	RPDLimit	Qual
Nitrogen, Kjeldahl, Total	0.47	0	0.5000	0	93.8	50	150			

Sample ID: LCS-79310	SampType: LCS	TestCode: EPA 351.2: TKN								
Client ID: LCSW	Batch ID: 79310	RunNo: 101810								
Prep Date: 12/12/2023	Analysis Date: 12/13/2023	SeqNo: 3753066	Units: mg/L							
Analyte	Result	PQL	SPK value	SPK Ref Val	%REC	LowLimit	HighLimit	%RPD	RPDLimit	Qual
Nitrogen, Kjeldahl, Total	10	0.50	10.00	0	101	90	110			

Qualifiers:

- | | |
|---|---|
| * Value exceeds Maximum Contaminant Level. | B Analyte detected in the associated Method Blank |
| D Sample Diluted Due to Matrix | E Above Quantitation Range/Estimated Value |
| H Holding times for preparation or analysis exceeded | J Analyte detected below quantitation limits |
| ND Not Detected at the Reporting Limit | P Sample pH Not In Range |
| PQL Practical Quantitative Limit | RL Reporting Limit |
| S % Recovery outside of standard limits. If undiluted results may be estimated. | |

December 20, 2023

Regina Mullen
EA Engineering
320 Gold Ave SW Suite 1210
Albuquerque, NM 87102
TEL:
FAX:

RE: Dominguez Dairy 2

OrderNo.: 2311943

Dear Regina Mullen:

Eurofins Environment Testing South Central, LLC received 5 sample(s) on 11/17/2023 for the analyses presented in the following report.

These were analyzed according to EPA procedures or equivalent. To access our accredited tests please go to www.hallenvironmental.com or the state specific web sites. In order to properly interpret your results, it is imperative that you review this report in its entirety. See the sample checklist and/or the Chain of Custody for information regarding the sample receipt temperature and preservation. Data qualifiers or a narrative will be provided if the sample analysis or analytical quality control parameters require a flag. When necessary, data qualifiers are provided on both the sample analysis report and the QC summary report, both sections should be reviewed. All samples are reported, as received, unless otherwise indicated. Lab measurement of analytes considered field parameters that require analysis within 15 minutes of sampling such as pH and residual chlorine are qualified as being analyzed outside of the recommended holding time.

Please do not hesitate to contact Eurofins Albuquerque for any additional information or clarifications.

ADHS Cert #AZ0682 -- NMED-DWB Cert #NM9425 -- NMED-Micro Cert #NM0901

Sincerely,



Andy Freeman
Laboratory Manager
4901 Hawkins NE
Albuquerque, NM 87109

Hall Environmental Analysis Laboratory, Inc.

Analytical Report

Lab Order 2311943

Date Reported: 12/20/2023

CLIENT: EA Engineering

Client Sample ID: 42-03

Project: Dominguez Dairy 2

Collection Date: 11/16/2023 10:47:00 AM

Lab ID: 2311943-001

Matrix: GROUNDWA

Received Date: 11/17/2023 8:50:00 AM

Analyses	Result	RL	Qual	Units	DF	Date Analyzed	Batch
EPA METHOD 300.0: ANIONS							Analyst: JMT
Chloride	980	50	*	mg/L	100	11/17/2023 2:19:33 PM	R101292
Nitrogen, Nitrite (As N)	ND	1.0		mg/L	10	11/17/2023 2:07:08 PM	R101292
Nitrogen, Nitrate (As N)	38	1.0	*	mg/L	10	11/17/2023 2:07:08 PM	R101292
SM2540C MOD: TOTAL DISSOLVED SOLIDS							Analyst: KS
Total Dissolved Solids	3170	50.0	*	mg/L	1	11/28/2023 1:22:00 PM	78925
EPA 351.2: TKN							Analyst: DML
Nitrogen, Kjeldahl, Total	ND	0.50		mg/L	1	12/13/2023 5:26:51 PM	79320

Refer to the QC Summary report and sample login checklist for flagged QC data and preservation information.

Qualifiers:	*	Value exceeds Maximum Contaminant Level.	B	Analyte detected in the associated Method Blank
	D	Sample Diluted Due to Matrix	E	Above Quantitation Range/Estimated Value
	H	Holding times for preparation or analysis exceeded	J	Analyte detected below quantitation limits
	ND	Not Detected at the Reporting Limit	P	Sample pH Not In Range
	PQL	Practical Quantitative Limit	RL	Reporting Limit
	S	% Recovery outside of standard limits. If undiluted results may be estimated.		

Hall Environmental Analysis Laboratory, Inc.

Analytical Report

Lab Order 2311943

Date Reported: 12/20/2023

CLIENT: EA Engineering

Client Sample ID: 42-13

Project: Dominguez Dairy 2

Collection Date: 11/16/2023 12:50:00 PM

Lab ID: 2311943-002

Matrix: GROUNDWA

Received Date: 11/17/2023 8:50:00 AM

Analyses	Result	RL	Qual	Units	DF	Date Analyzed	Batch
EPA METHOD 300.0: ANIONS							Analyst: JMT
Chloride	990	50	*	mg/L	100	11/17/2023 2:44:22 PM	R101292
Nitrogen, Nitrite (As N)	ND	1.0		mg/L	10	11/17/2023 2:31:58 PM	R101292
Nitrogen, Nitrate (As N)	38	1.0	*	mg/L	10	11/17/2023 2:31:58 PM	R101292
SM2540C MOD: TOTAL DISSOLVED SOLIDS							Analyst: KS
Total Dissolved Solids	3150	50.0	*	mg/L	1	11/28/2023 1:22:00 PM	78925
EPA 351.2: TKN							Analyst: DML
Nitrogen, Kjeldahl, Total	ND	0.50		mg/L	1	12/13/2023 5:31:22 PM	79320

Refer to the QC Summary report and sample login checklist for flagged QC data and preservation information.

Qualifiers:	*	Value exceeds Maximum Contaminant Level.	B	Analyte detected in the associated Method Blank
	D	Sample Diluted Due to Matrix	E	Above Quantitation Range/Estimated Value
	H	Holding times for preparation or analysis exceeded	J	Analyte detected below quantitation limits
	ND	Not Detected at the Reporting Limit	P	Sample pH Not In Range
	PQL	Practical Quantitative Limit	RL	Reporting Limit
	S	% Recovery outside of standard limits. If undiluted results may be estimated.		

Hall Environmental Analysis Laboratory, Inc.

Analytical Report

Lab Order 2311943

Date Reported: 12/20/2023

CLIENT: EA Engineering

Client Sample ID: 42-02

Project: Dominguez Dairy 2

Collection Date: 11/16/2023 3:00:00 PM

Lab ID: 2311943-003

Matrix: GROUNDWA

Received Date: 11/17/2023 8:50:00 AM

Analyses	Result	RL	Qual	Units	DF	Date Analyzed	Batch
EPA METHOD 300.0: ANIONS							Analyst: JMT
Chloride	500	50	*	mg/L	100	11/17/2023 3:09:12 PM	R101292
Nitrogen, Nitrite (As N)	ND	1.0		mg/L	10	11/17/2023 2:56:47 PM	R101292
Nitrogen, Nitrate (As N)	7.4	1.0		mg/L	10	11/17/2023 2:56:47 PM	R101292
SM2540C MOD: TOTAL DISSOLVED SOLIDS							Analyst: KS
Total Dissolved Solids	2570	50.0	*	mg/L	1	11/28/2023 1:22:00 PM	78925
EPA 351.2: TKN							Analyst: DML
Nitrogen, Kjeldahl, Total	0.71	0.50		mg/L	1	12/13/2023 5:32:52 PM	79320

Refer to the QC Summary report and sample login checklist for flagged QC data and preservation information.

Qualifiers:	*	Value exceeds Maximum Contaminant Level.	B	Analyte detected in the associated Method Blank
	D	Sample Diluted Due to Matrix	E	Above Quantitation Range/Estimated Value
	H	Holding times for preparation or analysis exceeded	J	Analyte detected below quantitation limits
	ND	Not Detected at the Reporting Limit	P	Sample pH Not In Range
	PQL	Practical Quantitative Limit	RL	Reporting Limit
	S	% Recovery outside of standard limits. If undiluted results may be estimated.		

Hall Environmental Analysis Laboratory, Inc.

Analytical Report

Lab Order 2311943

Date Reported: 12/20/2023

CLIENT: EA Engineering

Client Sample ID: 42-08

Project: Dominguez Dairy 2

Collection Date: 11/16/2023 3:41:00 PM

Lab ID: 2311943-004

Matrix: GROUNDWA

Received Date: 11/17/2023 8:50:00 AM

Analyses	Result	RL	Qual	Units	DF	Date Analyzed	Batch
EPA METHOD 300.0: ANIONS							Analyst: JMT
Chloride	500	50	*	mg/L	100	11/17/2023 3:58:50 PM	R101292
Nitrogen, Nitrite (As N)	ND	1.0		mg/L	10	11/17/2023 3:46:25 PM	R101292
Nitrogen, Nitrate (As N)	7.3	1.0		mg/L	10	11/17/2023 3:46:25 PM	R101292
SM2540C MOD: TOTAL DISSOLVED SOLIDS							Analyst: KS
Total Dissolved Solids	2540	50.0	*	mg/L	1	11/28/2023 1:22:00 PM	78925
EPA 351.2: TKN							Analyst: DML
Nitrogen, Kjeldahl, Total	0.81	0.50		mg/L	1	12/13/2023 5:34:22 PM	79320

Refer to the QC Summary report and sample login checklist for flagged QC data and preservation information.

Qualifiers:	*	Value exceeds Maximum Contaminant Level.	B	Analyte detected in the associated Method Blank
	D	Sample Diluted Due to Matrix	E	Above Quantitation Range/Estimated Value
	H	Holding times for preparation or analysis exceeded	J	Analyte detected below quantitation limits
	ND	Not Detected at the Reporting Limit	P	Sample pH Not In Range
	PQL	Practical Quantitative Limit	RL	Reporting Limit
	S	% Recovery outside of standard limits. If undiluted results may be estimated.		

Hall Environmental Analysis Laboratory, Inc.

Analytical Report

Lab Order 2311943

Date Reported: 12/20/2023

CLIENT: EA Engineering

Client Sample ID: 42-06

Project: Dominguez Dairy 2

Collection Date: 11/16/2023 5:00:00 PM

Lab ID: 2311943-005

Matrix: GROUNDWA

Received Date: 11/17/2023 8:50:00 AM

Analyses	Result	RL	Qual	Units	DF	Date Analyzed	Batch
EPA METHOD 300.0: ANIONS							Analyst: JMT
Chloride	330	50	*	mg/L	100	11/17/2023 4:23:39 PM	R101292
Nitrogen, Nitrite (As N)	ND	1.0		mg/L	10	11/17/2023 4:11:15 PM	R101292
Nitrogen, Nitrate (As N)	66	1.0	*	mg/L	10	11/17/2023 4:11:15 PM	R101292
SM2540C MOD: TOTAL DISSOLVED SOLIDS							Analyst: KS
Total Dissolved Solids	2090	100	*D	mg/L	1	11/28/2023 1:22:00 PM	78925
EPA 351.2: TKN							Analyst: DML
Nitrogen, Kjeldahl, Total	ND	0.50		mg/L	1	12/13/2023 5:35:52 PM	79320

Refer to the QC Summary report and sample login checklist for flagged QC data and preservation information.

Qualifiers:	*	Value exceeds Maximum Contaminant Level.	B	Analyte detected in the associated Method Blank
	D	Sample Diluted Due to Matrix	E	Above Quantitation Range/Estimated Value
	H	Holding times for preparation or analysis exceeded	J	Analyte detected below quantitation limits
	ND	Not Detected at the Reporting Limit	P	Sample pH Not In Range
	PQL	Practical Quantitative Limit	RL	Reporting Limit
	S	% Recovery outside of standard limits. If undiluted results may be estimated.		

QC SUMMARY REPORT

Hall Environmental Analysis Laboratory, Inc.

WO#: 2311943

20-Dec-23

Client: EA Engineering
Project: Dominguez Dairy 2

Sample ID: MB	SampType: mblk	TestCode: EPA Method 300.0: Anions								
Client ID: PBW	Batch ID: R101292	RunNo: 101292								
Prep Date:	Analysis Date: 11/17/2023	SeqNo: 3725188			Units: mg/L					
Analyte	Result	PQL	SPK value	SPK Ref Val	%REC	LowLimit	HighLimit	%RPD	RPDLimit	Qual
Chloride	ND	0.50								
Nitrogen, Nitrite (As N)	ND	0.10								
Nitrogen, Nitrate (As N)	ND	0.10								

Sample ID: LCS	SampType: ics	TestCode: EPA Method 300.0: Anions								
Client ID: LCSW	Batch ID: R101292	RunNo: 101292								
Prep Date:	Analysis Date: 11/17/2023	SeqNo: 3725189			Units: mg/L					
Analyte	Result	PQL	SPK value	SPK Ref Val	%REC	LowLimit	HighLimit	%RPD	RPDLimit	Qual
Chloride	5.0	0.50	5.000	0	99.5	90	110			
Nitrogen, Nitrite (As N)	1.0	0.10	1.000	0	102	90	110			
Nitrogen, Nitrate (As N)	2.6	0.10	2.500	0	105	90	110			

Qualifiers:

- * Value exceeds Maximum Contaminant Level.
- D Sample Diluted Due to Matrix
- H Holding times for preparation or analysis exceeded
- ND Not Detected at the Reporting Limit
- PQL Practical Quantitative Limit
- S % Recovery outside of standard limits. If undiluted results may be estimated.
- B Analyte detected in the associated Method Blank
- E Above Quantitation Range/Estimated Value
- J Analyte detected below quantitation limits
- P Sample pH Not In Range
- RL Reporting Limit

QC SUMMARY REPORT

Hall Environmental Analysis Laboratory, Inc.

WO#: 2311943

20-Dec-23

Client: EA Engineering
Project: Dominguez Dairy 2

Sample ID: MB-78925	SampType: MBLK	TestCode: SM2540C MOD: Total Dissolved Solids								
Client ID: PBW	Batch ID: 78925	RunNo: 101437								
Prep Date: 11/21/2023	Analysis Date: 11/28/2023	SeqNo: 3732357	Units: mg/L							
Analyte	Result	PQL	SPK value	SPK Ref Val	%REC	LowLimit	HighLimit	%RPD	RPDLimit	Qual
Total Dissolved Solids	ND	50.0								

Sample ID: LCS-78925	SampType: LCS	TestCode: SM2540C MOD: Total Dissolved Solids								
Client ID: LCSW	Batch ID: 78925	RunNo: 101437								
Prep Date: 11/21/2023	Analysis Date: 11/28/2023	SeqNo: 3732358	Units: mg/L							
Analyte	Result	PQL	SPK value	SPK Ref Val	%REC	LowLimit	HighLimit	%RPD	RPDLimit	Qual
Total Dissolved Solids	1060	50.0	1000	0	106	80	120			

Sample ID: 2311943-002ADUP	SampType: DUP	TestCode: SM2540C MOD: Total Dissolved Solids								
Client ID: 42-13	Batch ID: 78925	RunNo: 101437								
Prep Date: 11/21/2023	Analysis Date: 11/28/2023	SeqNo: 3732372	Units: mg/L							
Analyte	Result	PQL	SPK value	SPK Ref Val	%REC	LowLimit	HighLimit	%RPD	RPDLimit	Qual
Total Dissolved Solids	3170	50.0						0.633	10	*

Qualifiers:

- * Value exceeds Maximum Contaminant Level.
- D Sample Diluted Due to Matrix
- H Holding times for preparation or analysis exceeded
- ND Not Detected at the Reporting Limit
- PQL Practical Quantitative Limit
- S % Recovery outside of standard limits. If undiluted results may be estimated.
- B Analyte detected in the associated Method Blank
- E Above Quantitation Range/Estimated Value
- J Analyte detected below quantitation limits
- P Sample pH Not In Range
- RL Reporting Limit

QC SUMMARY REPORT

Hall Environmental Analysis Laboratory, Inc.

WO#: 2311943

20-Dec-23

Client: EA Engineering
Project: Dominguez Dairy 2

Sample ID: MB-79320	SampType: MBLK	TestCode: EPA 351.2: TKN								
Client ID: PBW	Batch ID: 79320	RunNo: 101810								
Prep Date: 12/12/2023	Analysis Date: 12/13/2023	SeqNo: 3753144	Units: mg/L							
Analyte	Result	PQL	SPK value	SPK Ref Val	%REC	LowLimit	HighLimit	%RPD	RPDLimit	Qual
Nitrogen, Kjeldahl, Total	ND	0.50								

Sample ID: LCSLL-79320	SampType: LCSLL	TestCode: EPA 351.2: TKN								
Client ID: BatchQC	Batch ID: 79320	RunNo: 101810								
Prep Date: 12/12/2023	Analysis Date: 12/13/2023	SeqNo: 3753145	Units: mg/L							
Analyte	Result	PQL	SPK value	SPK Ref Val	%REC	LowLimit	HighLimit	%RPD	RPDLimit	Qual
Nitrogen, Kjeldahl, Total	0.50	0.50	0.5000	0	100	50	150			

Sample ID: LCS-79320	SampType: LCS	TestCode: EPA 351.2: TKN								
Client ID: LCSW	Batch ID: 79320	RunNo: 101810								
Prep Date: 12/12/2023	Analysis Date: 12/13/2023	SeqNo: 3753148	Units: mg/L							
Analyte	Result	PQL	SPK value	SPK Ref Val	%REC	LowLimit	HighLimit	%RPD	RPDLimit	Qual
Nitrogen, Kjeldahl, Total	10	0.50	10.00	0	99.6	90	110			

Sample ID: 2311943-001AMS	SampType: MS	TestCode: EPA 351.2: TKN								
Client ID: 42-03	Batch ID: 79320	RunNo: 101810								
Prep Date: 12/12/2023	Analysis Date: 12/13/2023	SeqNo: 3753150	Units: mg/L							
Analyte	Result	PQL	SPK value	SPK Ref Val	%REC	LowLimit	HighLimit	%RPD	RPDLimit	Qual
Nitrogen, Kjeldahl, Total	4.0	0.50	10.00	0	40.4	90	110			S

Sample ID: 2311943-001AMSD	SampType: MSD	TestCode: EPA 351.2: TKN								
Client ID: 42-03	Batch ID: 79320	RunNo: 101810								
Prep Date: 12/12/2023	Analysis Date: 12/13/2023	SeqNo: 3753151	Units: mg/L							
Analyte	Result	PQL	SPK value	SPK Ref Val	%REC	LowLimit	HighLimit	%RPD	RPDLimit	Qual
Nitrogen, Kjeldahl, Total	5.1	0.50	10.00	0	51.1	90	110	23.5	0	S

Qualifiers:

- * Value exceeds Maximum Contaminant Level.
- D Sample Diluted Due to Matrix
- H Holding times for preparation or analysis exceeded
- ND Not Detected at the Reporting Limit
- PQL Practical Quantitative Limit
- S % Recovery outside of standard limits. If undiluted results may be estimated.
- B Analyte detected in the associated Method Blank
- E Above Quantitation Range/Estimated Value
- J Analyte detected below quantitation limits
- P Sample pH Not In Range
- RL Reporting Limit

Sample Log-In Check List

Client Name: EA Engineering

Work Order Number: 2311943

RcptNo: 1

Received By: Desiree Dominguez

11/17/2023 8:50:00 AM

DD

Completed By: Desiree Dominguez

11/17/2023 9:51:47 AM

DD

Reviewed By: *Jul 11/17/23*

Chain of Custody

1. Is Chain of Custody complete? Yes No Not Present
2. How was the sample delivered? FedEx

Log In

3. Was an attempt made to cool the samples? Yes No NA
4. Were all samples received at a temperature of >0° C to 6.0°C Yes No NA
5. Sample(s) in proper container(s)? ~~Samples were collected the same day and chilled.~~ *11/17/23* Yes No
6. Sufficient sample volume for indicated test(s)? Yes No
7. Are samples (except VOA and ONG) properly preserved? Yes No
8. Was preservative added to bottles? Yes No NA
9. Received at least 1 vial with headspace <1/4" for AQ VOA? Yes No NA
10. Were any sample containers received broken? Yes No
11. Does paperwork match bottle labels? Yes No
(Note discrepancies on chain of custody)
12. Are matrices correctly identified on Chain of Custody? Yes No
13. Is it clear what analyses were requested? Yes No
14. Were all holding times able to be met? Yes No
(If no, notify customer for authorization.)

of preserved bottles checked for pH: 5
(2) or >12 unless noted

Adjusted? NO

Checked by: DA D 11/17/23

Special Handling (if applicable)

15. Was client notified of all discrepancies with this order? Yes No NA

Person Notified:	<input type="text"/>	Date:	<input type="text"/>
By Whom:	<input type="text"/>	Via:	<input type="checkbox"/> eMail <input type="checkbox"/> Phone <input type="checkbox"/> Fax <input type="checkbox"/> In Person
Regarding:	<input type="text"/>		
Client Instructions:	<input type="text"/>		

16. Additional remarks:

17. Cooler Information

Cooler No	Temp °C	Condition	Seal Intact	Seal No	Seal Date	Signed By
1	0.8	Good	Not Present	Yogi		

Chain-of-Custody Record

Client: _____
 EA Engineering, Science, and Technology
 Mailing Address: _____
 320 Gold Ave SW Suite _____
 Phone #: 505-715-4279

email or Fax#: rnullen@eaest.com
 QA/QC Package: _____
 Standard Level 4 (Full Validation)
 Accreditation: Az Compliance
 NELAC Other _____
 EDD (Type) _____

Turn-Around Time: _____
 Standard Rush
 Project Name: _____
 Dominguez Dairy 2
 Project #: _____

Project Manager: Gina Mullen
 Sampler: Angel N. Rivera
 On Ice: Yes No
 # of Coolers: 1
 Cooler Temp (including CFM): 0.8 ± 0.0 = 0.8 ±

Container Type and # _____
 Preservative Type _____
 HEAL No. 2311943
 -001
 -002
 -003
 -004
 -005

Date	Time	Matrix	Sample Name
11-16	10:47	GW	42-03
11-16	12:50	GW	42-13
11-16	15:00	GW	42-02
11-16	15:41	GW	42-08
11-16	17:00	GW	42-06

Date: 11-16 Time: 18:30
 Relinquished by: *[Signature]*
 Date: 11-17 Time: 08:50
 Relinquished by: *[Signature]*

Received by: *[Signature]* Date: 11/17/23 Time: 08:50
 Via: Fed Ex
 Received by: _____ Date: _____ Time: _____
 Via: _____



HALL ENVIRONMENTAL ANALYSIS LABORATORY
 www.hallenvironmental.com
 4901 Hawkins NE - Albuquerque, NM 87109
 Tel. 505-345-3975 Fax 505-345-4107

Analysis Request

Nitrate/Nitrites EPA Method 300	TKN SM 4500 NORG C	Chloride EPA 300	TDS SM 2540 C MOD	Sulfate EPA 300	Phosphorus EPA 6010B	Total Sulfur
X	X	X	X			
X	X	X	X			
X	X	X	X			
X	X	X	X			
X	X	X	X			

Remarks: _____

If necessary, samples submitted to Hall Environmental may be subcontracted to other accredited laboratories. This serves as notice of this possibility. Any sub-contracted data will be clearly notated on the analytical report.

January 15, 2024

Regina Mullen
EA Engineering
320 Gold Ave SW Suite 1210
Albuquerque, NM 87102
TEL:
FAX:

RE: Del Oro Dairy

OrderNo.: 2312093

Dear Regina Mullen:

Eurofins Environment Testing South Central, LLC received 4 sample(s) on 12/2/2023 for the analyses presented in the following report.

These were analyzed according to EPA procedures or equivalent. To access our accredited tests please go to www.hallenvironmental.com or the state specific web sites. In order to properly interpret your results, it is imperative that you review this report in its entirety. See the sample checklist and/or the Chain of Custody for information regarding the sample receipt temperature and preservation. Data qualifiers or a narrative will be provided if the sample analysis or analytical quality control parameters require a flag. When necessary, data qualifiers are provided on both the sample analysis report and the QC summary report, both sections should be reviewed. All samples are reported, as received, unless otherwise indicated. Lab measurement of analytes considered field parameters that require analysis within 15 minutes of sampling such as pH and residual chlorine are qualified as being analyzed outside of the recommended holding time.

Please do not hesitate to contact Eurofins Albuquerque for any additional information or clarifications.

ADHS Cert #AZ0682 -- NMED-DWB Cert #NM9425 -- NMED-Micro Cert #NM0901

Sincerely,



Andy Freeman
Laboratory Manager
4901 Hawkins NE
Albuquerque, NM 87109

Hall Environmental Analysis Laboratory, Inc.

Analytical Report

Lab Order 2312093

Date Reported: 1/15/2024

CLIENT: EA Engineering

Client Sample ID: 692-05

Project: Del Oro Dairy

Collection Date: 12/1/2023 11:05:00 AM

Lab ID: 2312093-001

Matrix: GROUNDWA

Received Date: 12/2/2023 11:30:00 AM

Analyses	Result	RL	Qual	Units	DF	Date Analyzed	Batch
EPA METHOD 300.0: ANIONS							Analyst: JMT
Chloride	430	50	*	mg/L	100	12/4/2023 3:25:40 PM	R101592
Sulfate	290	5.0	*	mg/L	10	12/4/2023 3:12:47 PM	R101592
Nitrate+Nitrite as N	19	1.0	*	mg/L	5	12/4/2023 11:04:25 PM	R101592
SM2540C MOD: TOTAL DISSOLVED SOLIDS							Analyst: KS
Total Dissolved Solids	1610	100	*D	mg/L	1	12/8/2023 4:07:00 PM	79215
EPA 351.2: TKN							Analyst: DML
Nitrogen, Kjeldahl, Total	ND	0.50		mg/L	1	12/29/2023 2:35:40 PM	79636

Refer to the QC Summary report and sample login checklist for flagged QC data and preservation information.

Qualifiers:	*	Value exceeds Maximum Contaminant Level.	B	Analyte detected in the associated Method Blank
	D	Sample Diluted Due to Matrix	E	Above Quantitation Range/Estimated Value
	H	Holding times for preparation or analysis exceeded	J	Analyte detected below quantitation limits
	ND	Not Detected at the Reporting Limit	P	Sample pH Not In Range
	PQL	Practical Quantitative Limit	RL	Reporting Limit
	S	% Recovery outside of standard limits. If undiluted results may be estimated.		

Hall Environmental Analysis Laboratory, Inc.

Analytical Report

Lab Order 2312093

Date Reported: 1/15/2024

CLIENT: EA Engineering

Client Sample ID: 692-06

Project: Del Oro Dairy

Collection Date: 12/1/2023 12:50:00 PM

Lab ID: 2312093-002

Matrix: GROUNDWA

Received Date: 12/2/2023 11:30:00 AM

Analyses	Result	RL	Qual	Units	DF	Date Analyzed	Batch
EPA METHOD 300.0: ANIONS							Analyst: JMT
Chloride	430	50	*	mg/L	100	12/4/2023 3:51:25 PM	R101592
Sulfate	220	5.0		mg/L	10	12/4/2023 3:38:33 PM	R101592
Nitrate+Nitrite as N	4.3	1.0		mg/L	5	12/4/2023 11:17:15 PM	R101592
SM2540C MOD: TOTAL DISSOLVED SOLIDS							Analyst: KS
Total Dissolved Solids	1450	100	*D	mg/L	1	12/8/2023 4:07:00 PM	79215
EPA 351.2: TKN							Analyst: DML
Nitrogen, Kjeldahl, Total	ND	0.50		mg/L	1	12/29/2023 2:37:10 PM	79636

Refer to the QC Summary report and sample login checklist for flagged QC data and preservation information.

Qualifiers:	*	Value exceeds Maximum Contaminant Level.	B	Analyte detected in the associated Method Blank
	D	Sample Diluted Due to Matrix	E	Above Quantitation Range/Estimated Value
	H	Holding times for preparation or analysis exceeded	J	Analyte detected below quantitation limits
	ND	Not Detected at the Reporting Limit	P	Sample pH Not In Range
	PQL	Practical Quantitative Limit	RL	Reporting Limit
	S	% Recovery outside of standard limits. If undiluted results may be estimated.		

Hall Environmental Analysis Laboratory, Inc.

Analytical Report

Lab Order 2312093

Date Reported: 1/15/2024

CLIENT: EA Engineering

Client Sample ID: 692-07

Project: Del Oro Dairy

Collection Date: 12/1/2023 2:20:00 PM

Lab ID: 2312093-003

Matrix: GROUNDWA

Received Date: 12/2/2023 11:30:00 AM

Analyses	Result	RL	Qual	Units	DF	Date Analyzed	Batch
EPA METHOD 300.0: ANIONS							Analyst: JMT
Chloride	550	50	*	mg/L	100	12/4/2023 4:17:07 PM	R101592
Sulfate	210	5.0		mg/L	10	12/4/2023 4:04:16 PM	R101592
Nitrate+Nitrite as N	2.6	1.0		mg/L	5	12/4/2023 11:30:07 PM	R101592
SM2540C MOD: TOTAL DISSOLVED SOLIDS							Analyst: KS
Total Dissolved Solids	1600	50.0	*	mg/L	1	12/8/2023 4:07:00 PM	79215
EPA 351.2: TKN							Analyst: DML
Nitrogen, Kjeldahl, Total	ND	0.50		mg/L	1	12/29/2023 2:38:40 PM	79636

Refer to the QC Summary report and sample login checklist for flagged QC data and preservation information.

Qualifiers:	*	Value exceeds Maximum Contaminant Level.	B	Analyte detected in the associated Method Blank
	D	Sample Diluted Due to Matrix	E	Above Quantitation Range/Estimated Value
	H	Holding times for preparation or analysis exceeded	J	Analyte detected below quantitation limits
	ND	Not Detected at the Reporting Limit	P	Sample pH Not In Range
	PQL	Practical Quantitative Limit	RL	Reporting Limit
	S	% Recovery outside of standard limits. If undiluted results may be estimated.		

Hall Environmental Analysis Laboratory, Inc.

Analytical Report

Lab Order 2312093

Date Reported: 1/15/2024

CLIENT: EA Engineering

Client Sample ID: 692-10

Project: Del Oro Dairy

Collection Date: 12/1/2023 3:30:00 PM

Lab ID: 2312093-004

Matrix: GROUNDWA

Received Date: 12/2/2023 11:30:00 AM

Analyses	Result	RL	Qual	Units	DF	Date Analyzed	Batch
EPA METHOD 300.0: ANIONS							Analyst: JMT
Chloride	660	50	*	mg/L	100	12/4/2023 4:42:51 PM	R101592
Sulfate	200	5.0		mg/L	10	12/4/2023 4:30:00 PM	R101592
Nitrate+Nitrite as N	ND	1.0		mg/L	5	12/4/2023 11:42:59 PM	R101592
SM2540C MOD: TOTAL DISSOLVED SOLIDS							Analyst: KS
Total Dissolved Solids	1610	500	*D	mg/L	1	12/8/2023 4:07:00 PM	79215
EPA 351.2: TKN							Analyst: DML
Nitrogen, Kjeldahl, Total	ND	2.5	D	mg/L	1	12/29/2023 2:40:10 PM	79636

Refer to the QC Summary report and sample login checklist for flagged QC data and preservation information.

Qualifiers:	*	Value exceeds Maximum Contaminant Level.	B	Analyte detected in the associated Method Blank
	D	Sample Diluted Due to Matrix	E	Above Quantitation Range/Estimated Value
	H	Holding times for preparation or analysis exceeded	J	Analyte detected below quantitation limits
	ND	Not Detected at the Reporting Limit	P	Sample pH Not In Range
	PQL	Practical Quantitative Limit	RL	Reporting Limit
	S	% Recovery outside of standard limits. If undiluted results may be estimated.		

QC SUMMARY REPORT

Hall Environmental Analysis Laboratory, Inc.

WO#: 2312093

15-Jan-24

Client: EA Engineering
Project: Del Oro Dairy

Sample ID: MB	SampType: mblk	TestCode: EPA Method 300.0: Anions								
Client ID: PBW	Batch ID: R101592	RunNo: 101592								
Prep Date:	Analysis Date: 12/4/2023	SeqNo: 3741217	Units: mg/L							
Analyte	Result	PQL	SPK value	SPK Ref Val	%REC	LowLimit	HighLimit	%RPD	RPDLimit	Qual
Chloride	ND	0.50								
Sulfate	ND	0.50								
Nitrate+Nitrite as N	ND	0.20								

Sample ID: LCS	SampType: lcs	TestCode: EPA Method 300.0: Anions								
Client ID: LCSW	Batch ID: R101592	RunNo: 101592								
Prep Date:	Analysis Date: 12/4/2023	SeqNo: 3741218	Units: mg/L							
Analyte	Result	PQL	SPK value	SPK Ref Val	%REC	LowLimit	HighLimit	%RPD	RPDLimit	Qual
Chloride	4.8	0.50	5.000	0	95.1	90	110			
Sulfate	9.6	0.50	10.00	0	96.5	90	110			
Nitrate+Nitrite as N	3.4	0.20	3.500	0	98.2	90	110			

Qualifiers:

- * Value exceeds Maximum Contaminant Level.
- D Sample Diluted Due to Matrix
- H Holding times for preparation or analysis exceeded
- ND Not Detected at the Reporting Limit
- PQL Practical Quantitative Limit
- S % Recovery outside of standard limits. If undiluted results may be estimated.
- B Analyte detected in the associated Method Blank
- E Above Quantitation Range/Estimated Value
- J Analyte detected below quantitation limits
- P Sample pH Not In Range
- RL Reporting Limit

QC SUMMARY REPORT

Hall Environmental Analysis Laboratory, Inc.

WO#: 2312093

15-Jan-24

Client: EA Engineering
Project: Del Oro Dairy

Sample ID: MB-79215	SampType: MBLK	TestCode: SM2540C MOD: Total Dissolved Solids								
Client ID: PBW	Batch ID: 79215	RunNo: 101719								
Prep Date: 12/7/2023	Analysis Date: 12/8/2023	SeqNo: 3747840	Units: mg/L							
Analyte	Result	PQL	SPK value	SPK Ref Val	%REC	LowLimit	HighLimit	%RPD	RPDLimit	Qual
Total Dissolved Solids	ND	50.0								

Sample ID: LCS-79215	SampType: LCS	TestCode: SM2540C MOD: Total Dissolved Solids								
Client ID: LCSW	Batch ID: 79215	RunNo: 101719								
Prep Date: 12/7/2023	Analysis Date: 12/8/2023	SeqNo: 3747841	Units: mg/L							
Analyte	Result	PQL	SPK value	SPK Ref Val	%REC	LowLimit	HighLimit	%RPD	RPDLimit	Qual
Total Dissolved Solids	992	50.0	1000	0	99.2	80	120			

Qualifiers:

- * Value exceeds Maximum Contaminant Level.
- D Sample Diluted Due to Matrix
- H Holding times for preparation or analysis exceeded
- ND Not Detected at the Reporting Limit
- PQL Practical Quantitative Limit
- S % Recovery outside of standard limits. If undiluted results may be estimated.
- B Analyte detected in the associated Method Blank
- E Above Quantitation Range/Estimated Value
- J Analyte detected below quantitation limits
- P Sample pH Not In Range
- RL Reporting Limit

QC SUMMARY REPORT

Hall Environmental Analysis Laboratory, Inc.

WO#: 2312093

15-Jan-24

Client: EA Engineering
Project: Del Oro Dairy

Sample ID: MB-79636	SampType: MBLK	TestCode: EPA 351.2: TKN								
Client ID: PBW	Batch ID: 79636	RunNo: 102166								
Prep Date: 12/28/2023	Analysis Date: 12/29/2023	SeqNo: 3771551	Units: mg/L							
Analyte	Result	PQL	SPK value	SPK Ref Val	%REC	LowLimit	HighLimit	%RPD	RPDLimit	Qual
Nitrogen, Kjeldahl, Total	ND	0.50								

Sample ID: LCSLL-79636	SampType: LCSLL	TestCode: EPA 351.2: TKN								
Client ID: BatchQC	Batch ID: 79636	RunNo: 102166								
Prep Date: 12/28/2023	Analysis Date: 12/29/2023	SeqNo: 3771552	Units: mg/L							
Analyte	Result	PQL	SPK value	SPK Ref Val	%REC	LowLimit	HighLimit	%RPD	RPDLimit	Qual
Nitrogen, Kjeldahl, Total	0.39	0	0.5000	0	77.2	50	150			

Sample ID: LCS-79636	SampType: LCS	TestCode: EPA 351.2: TKN								
Client ID: LCSW	Batch ID: 79636	RunNo: 102166								
Prep Date: 12/28/2023	Analysis Date: 12/29/2023	SeqNo: 3771553	Units: mg/L							
Analyte	Result	PQL	SPK value	SPK Ref Val	%REC	LowLimit	HighLimit	%RPD	RPDLimit	Qual
Nitrogen, Kjeldahl, Total	10	0.50	10.00	0	102	90	110			

Qualifiers:

- | | |
|---|---|
| * Value exceeds Maximum Contaminant Level. | B Analyte detected in the associated Method Blank |
| D Sample Diluted Due to Matrix | E Above Quantitation Range/Estimated Value |
| H Holding times for preparation or analysis exceeded | J Analyte detected below quantitation limits |
| ND Not Detected at the Reporting Limit | P Sample pH Not In Range |
| PQL Practical Quantitative Limit | RL Reporting Limit |
| S % Recovery outside of standard limits. If undiluted results may be estimated. | |

Sample Log-In Check List

Client Name: **EA Engineering** Work Order Number: **2312093** RcptNo: **1**

Received By: **Tracy Casarrubias** 12/2/2023 11:30:00 AM

Completed By: **Tracy Casarrubias** 12/2/2023 11:32:43 AM

Reviewed By: **JN 12/4/23**

Chain of Custody

1. Is Chain of Custody complete? Yes No Not Present

2. How was the sample delivered? Courier **FedEx** M# **12/4/23**

Log In

3. Was an attempt made to cool the samples? Yes No NA

4. Were all samples received at a temperature of >0° C to 6.0°C Yes No NA

5. Sample(s) in proper container(s)? Yes No

6. Sufficient sample volume for indicated test(s)? Yes No

7. Are samples (except VOA and ONG) properly preserved? Yes No

8. Was preservative added to bottles? Yes No NA

9. Received at least 1 vial with headspace <1/4" for AQ VOA? Yes No NA

10. Were any sample containers received broken? Yes No

11. Does paperwork match bottle labels? Yes No
(Note discrepancies on chain of custody)

12. Are matrices correctly identified on Chain of Custody? Yes No

13. Is it clear what analyses were requested? Yes No

14. Were all holding times able to be met? Yes No
(If no, notify customer for authorization.)

of preserved bottles checked for pH: **4**
(~~2~~ or >12 unless noted)

Adjusted? **NO**

Checked by: **TMC 12/2/23**

Special Handling (if applicable)

15. Was client notified of all discrepancies with this order? Yes No NA

Person Notified: Date:

By Whom: Via: eMail Phone Fax In Person

Regarding:

Client Instructions:

16. Additional remarks:

17. Cooler Information

Cooler No	Temp °C	Condition	Seal Intact	Seal No	Seal Date	Signed By
1	0.4	Good	Not Present	Morty		

Chain-of-Custody Record

Client: _____

EA Engineering, Science, and Technology
Mailing Address: _____

320 Gold Ave SW Suite _____
Phone #: 505-715-4279
email or Fax#: rmullen@eaest.com

QA/QC Package:
 Standard Level 4 (Full Validation)
 Accreditation: Az Compliance
 NELAC Other
 EDD (Type) _____

Turn-Around Time:
 Standard Rush

Project Name: _____

Project #: _____

Del Oro Dairy
Project Manager: Gina Mullen

Sampler: Angel N. Rivera
 On Job: Yes No *MOIST*
 # of Coolers: _____
 Cooler Temp (including CP): *0.4 - 0.4*

Date	Time	Matrix	Sample Name	Container Type and #	Preservative Type	HEAL No.
12-1	11:05	GW	692-05	2		2312093
12-1	12:50	GW	692-06	2		001
12-1	14:20	GW	692-07	2		002
12-1	15:30	GW	692-10	2		003
						004

Date: 12-1 Time: 17:25 Relinquished by: *Ad M*

Date: 12-1 Time: 11:30 Relinquished by: *[Signature]*

Received by: _____ Date: 12/2/23 Time: 11:30

Received by: _____ Date: _____ Time: _____

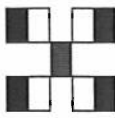

HALL ENVIRONMENTAL ANALYSIS LABORATORY

www.hallenvironmental.com
 4901 Hawkins NE - Albuquerque, NM 87109
 Tel. 505-345-3975 Fax 505-345-4107

Analysis Request

Nitrate/Nitrites EPA Method 300	TKN SM 4500 NORG C	Chloride EPA 300	TDS SM 2540 C MOD	Sulfate EPA 300	Phosphorus EPA 6010B	Total Sulfur
X	X	X	X	X		
X	X	X	X	X		
X	X	X	X	X		
X	X	X	X	X		

Remarks: _____

If necessary, samples submitted to Hall Environmental may be subcontracted to other accredited laboratories. This serves as notice of this possibility. Any sub-contracted data will be clearly notated on the analytical report.

January 15, 2024

Regina Mullen
EA Engineering
320 Gold Ave SW Suite 1210
Albuquerque, NM 87102
TEL:
FAX:

RE: Del Oro Dairy

OrderNo.: 2312185

Dear Regina Mullen:

Eurofins Environment Testing South Central, LLC received 3 sample(s) on 12/5/2023 for the analyses presented in the following report.

These were analyzed according to EPA procedures or equivalent. To access our accredited tests please go to www.hallenvironmental.com or the state specific web sites. In order to properly interpret your results, it is imperative that you review this report in its entirety. See the sample checklist and/or the Chain of Custody for information regarding the sample receipt temperature and preservation. Data qualifiers or a narrative will be provided if the sample analysis or analytical quality control parameters require a flag. When necessary, data qualifiers are provided on both the sample analysis report and the QC summary report, both sections should be reviewed. All samples are reported, as received, unless otherwise indicated. Lab measurement of analytes considered field parameters that require analysis within 15 minutes of sampling such as pH and residual chlorine are qualified as being analyzed outside of the recommended holding time.

Please do not hesitate to contact Eurofins Albuquerque for any additional information or clarifications.

ADHS Cert #AZ0682 -- NMED-DWB Cert #NM9425 -- NMED-Micro Cert #NM0901

Sincerely,



Andy Freeman
Laboratory Manager
4901 Hawkins NE
Albuquerque, NM 87109

Hall Environmental Analysis Laboratory, Inc.

Analytical Report

Lab Order 2312185

Date Reported: 1/15/2024

CLIENT: EA Engineering

Client Sample ID: 692-09

Project: Del Oro Dairy

Collection Date: 12/4/2023 11:09:00 AM

Lab ID: 2312185-001

Matrix: GROUNDWA

Received Date: 12/5/2023 8:55:00 AM

Analyses	Result	RL	Qual	Units	DF	Date Analyzed	Batch
EPA METHOD 300.0: ANIONS							Analyst: SNS
Chloride	400	50	*	mg/L	100	12/5/2023 11:01:03 PM	A101631
Nitrogen, Nitrite (As N)	ND	1.0		mg/L	10	12/5/2023 10:22:28 PM	A101631
Nitrogen, Nitrate (As N)	3.4	1.0		mg/L	10	12/5/2023 10:22:28 PM	A101631
Sulfate	210	5.0		mg/L	10	12/5/2023 10:22:28 PM	A101631
SM2540C MOD: TOTAL DISSOLVED SOLIDS							Analyst: KS
Total Dissolved Solids	1410	50.0	*	mg/L	1	12/11/2023 8:16:00 AM	79267
EPA 351.2: TKN							Analyst: DML
Nitrogen, Kjeldahl, Total	ND	0.50		mg/L	1	12/29/2023 4:21:03 PM	79642

Refer to the QC Summary report and sample login checklist for flagged QC data and preservation information.

Qualifiers:	*	Value exceeds Maximum Contaminant Level.	B	Analyte detected in the associated Method Blank
	D	Sample Diluted Due to Matrix	E	Above Quantitation Range/Estimated Value
	H	Holding times for preparation or analysis exceeded	J	Analyte detected below quantitation limits
	ND	Not Detected at the Reporting Limit	P	Sample pH Not In Range
	PQL	Practical Quantitative Limit	RL	Reporting Limit
	S	% Recovery outside of standard limits. If undiluted results may be estimated.		

Hall Environmental Analysis Laboratory, Inc.

Analytical Report

Lab Order 2312185

Date Reported: 1/15/2024

CLIENT: EA Engineering

Client Sample ID: 692-08

Project: Del Oro Dairy

Collection Date: 12/4/2023 2:17:00 PM

Lab ID: 2312185-002

Matrix: GROUNDWA

Received Date: 12/5/2023 8:55:00 AM

Analyses	Result	RL	Qual	Units	DF	Date Analyzed	Batch
EPA METHOD 300.0: ANIONS							Analyst: SNS
Chloride	400	50	*	mg/L	100	12/5/2023 11:26:46 PM	A101631
Nitrogen, Nitrite (As N)	ND	1.0		mg/L	10	12/5/2023 11:13:54 PM	A101631
Nitrogen, Nitrate (As N)	3.1	1.0		mg/L	10	12/5/2023 11:13:54 PM	A101631
Sulfate	200	5.0		mg/L	10	12/5/2023 11:13:54 PM	A101631
SM2540C MOD: TOTAL DISSOLVED SOLIDS							Analyst: KS
Total Dissolved Solids	1380	50.0	*	mg/L	1	12/11/2023 8:16:00 AM	79267
EPA 351.2: TKN							Analyst: DML
Nitrogen, Kjeldahl, Total	ND	0.50		mg/L	1	12/29/2023 4:22:33 PM	79642

Refer to the QC Summary report and sample login checklist for flagged QC data and preservation information.

Qualifiers:	*	Value exceeds Maximum Contaminant Level.	B	Analyte detected in the associated Method Blank
	D	Sample Diluted Due to Matrix	E	Above Quantitation Range/Estimated Value
	H	Holding times for preparation or analysis exceeded	J	Analyte detected below quantitation limits
	ND	Not Detected at the Reporting Limit	P	Sample pH Not In Range
	PQL	Practical Quantitative Limit	RL	Reporting Limit
	S	% Recovery outside of standard limits. If undiluted results may be estimated.		

Hall Environmental Analysis Laboratory, Inc.

Analytical Report

Lab Order 2312185

Date Reported: 1/15/2024

CLIENT: EA Engineering

Client Sample ID: EW-01

Project: Del Oro Dairy

Collection Date: 12/4/2023 3:40:00 PM

Lab ID: 2312185-003

Matrix: GROUNDWA

Received Date: 12/5/2023 8:55:00 AM

Analyses	Result	RL	Qual	Units	DF	Date Analyzed	Batch
EPA METHOD 300.0: ANIONS							Analyst: SNS
Chloride	1100	50	*	mg/L	100	12/5/2023 11:52:29 PM	A101631
Nitrogen, Nitrite (As N)	ND	1.0		mg/L	10	12/5/2023 11:39:38 PM	A101631
Nitrogen, Nitrate (As N)	190	10	*	mg/L	100	12/5/2023 11:52:29 PM	A101631
Sulfate	660	50	*	mg/L	100	12/5/2023 11:52:29 PM	A101631
SM2540C MOD: TOTAL DISSOLVED SOLIDS							Analyst: KS
Total Dissolved Solids	4340	50.0	*	mg/L	1	12/11/2023 8:16:00 AM	79267
EPA 351.2: TKN							Analyst: DML
Nitrogen, Kjeldahl, Total	ND	0.50		mg/L	1	12/29/2023 4:31:52 PM	79642

Refer to the QC Summary report and sample login checklist for flagged QC data and preservation information.

Qualifiers:	*	Value exceeds Maximum Contaminant Level.	B	Analyte detected in the associated Method Blank
	D	Sample Diluted Due to Matrix	E	Above Quantitation Range/Estimated Value
	H	Holding times for preparation or analysis exceeded	J	Analyte detected below quantitation limits
	ND	Not Detected at the Reporting Limit	P	Sample pH Not In Range
	PQL	Practical Quantitative Limit	RL	Reporting Limit
	S	% Recovery outside of standard limits. If undiluted results may be estimated.		

QC SUMMARY REPORT

Hall Environmental Analysis Laboratory, Inc.

WO#: 2312185

15-Jan-24

Client: EA Engineering
Project: Del Oro Dairy

Sample ID: MB	SampType: MBLK	TestCode: EPA Method 300.0: Anions								
Client ID: PBW	Batch ID: A101631	RunNo: 101631								
Prep Date:	Analysis Date: 12/5/2023	SeqNo: 3743171			Units: mg/L					
Analyte	Result	PQL	SPK value	SPK Ref Val	%REC	LowLimit	HighLimit	%RPD	RPDLimit	Qual
Chloride	ND	0.50								
Nitrogen, Nitrite (As N)	ND	0.10								
Nitrogen, Nitrate (As N)	ND	0.10								
Sulfate	ND	0.50								

Sample ID: LCS	SampType: LCS	TestCode: EPA Method 300.0: Anions								
Client ID: LCSW	Batch ID: A101631	RunNo: 101631								
Prep Date:	Analysis Date: 12/5/2023	SeqNo: 3743172			Units: mg/L					
Analyte	Result	PQL	SPK value	SPK Ref Val	%REC	LowLimit	HighLimit	%RPD	RPDLimit	Qual
Chloride	4.7	0.50	5.000	0	94.9	90	110			
Nitrogen, Nitrite (As N)	0.98	0.10	1.000	0	97.6	90	110			
Nitrogen, Nitrate (As N)	2.5	0.10	2.500	0	99.3	90	110			
Sulfate	9.6	0.50	10.00	0	96.3	90	110			

Sample ID: 2312185-001AMS	SampType: MS	TestCode: EPA Method 300.0: Anions								
Client ID: 692-09	Batch ID: A101631	RunNo: 101631								
Prep Date:	Analysis Date: 12/5/2023	SeqNo: 3743176			Units: mg/L					
Analyte	Result	PQL	SPK value	SPK Ref Val	%REC	LowLimit	HighLimit	%RPD	RPDLimit	Qual
Nitrogen, Nitrite (As N)	10	1.0	10.00	0.2903	98.1	80	120			
Nitrogen, Nitrate (As N)	29	1.0	25.00	3.424	103	80	120			
Sulfate	320	5.0	100.0	209.2	108	80	120			

Sample ID: 2312185-001AMSD	SampType: MSD	TestCode: EPA Method 300.0: Anions								
Client ID: 692-09	Batch ID: A101631	RunNo: 101631								
Prep Date:	Analysis Date: 12/5/2023	SeqNo: 3743177			Units: mg/L					
Analyte	Result	PQL	SPK value	SPK Ref Val	%REC	LowLimit	HighLimit	%RPD	RPDLimit	Qual
Nitrogen, Nitrite (As N)	10	1.0	10.00	0.2903	96.6	80	120	1.46	20	
Nitrogen, Nitrate (As N)	29	1.0	25.00	3.424	100	80	120	1.85	20	
Sulfate	310	5.0	100.0	209.2	100	80	120	2.50	20	

Qualifiers:

- * Value exceeds Maximum Contaminant Level.
- D Sample Diluted Due to Matrix
- H Holding times for preparation or analysis exceeded
- ND Not Detected at the Reporting Limit
- PQL Practical Quantitative Limit
- S % Recovery outside of standard limits. If undiluted results may be estimated.
- B Analyte detected in the associated Method Blank
- E Above Quantitation Range/Estimated Value
- J Analyte detected below quantitation limits
- P Sample pH Not In Range
- RL Reporting Limit

QC SUMMARY REPORT

Hall Environmental Analysis Laboratory, Inc.

WO#: 2312185

15-Jan-24

Client: EA Engineering
Project: Del Oro Dairy

Sample ID: MB-79267	SampType: MBLK	TestCode: SM2540C MOD: Total Dissolved Solids								
Client ID: PBW	Batch ID: 79267	RunNo: 101728								
Prep Date: 12/9/2023	Analysis Date: 12/11/2023	SeqNo: 3748381	Units: mg/L							
Analyte	Result	PQL	SPK value	SPK Ref Val	%REC	LowLimit	HighLimit	%RPD	RPDLimit	Qual
Total Dissolved Solids	ND	50.0								

Sample ID: LCS-79267	SampType: LCS	TestCode: SM2540C MOD: Total Dissolved Solids								
Client ID: LCSW	Batch ID: 79267	RunNo: 101728								
Prep Date: 12/9/2023	Analysis Date: 12/11/2023	SeqNo: 3748382	Units: mg/L							
Analyte	Result	PQL	SPK value	SPK Ref Val	%REC	LowLimit	HighLimit	%RPD	RPDLimit	Qual
Total Dissolved Solids	998	50.0	1000	0	99.8	80	120			

Qualifiers:

- * Value exceeds Maximum Contaminant Level.
- D Sample Diluted Due to Matrix
- H Holding times for preparation or analysis exceeded
- ND Not Detected at the Reporting Limit
- PQL Practical Quantitative Limit
- S % Recovery outside of standard limits. If undiluted results may be estimated.
- B Analyte detected in the associated Method Blank
- E Above Quantitation Range/Estimated Value
- J Analyte detected below quantitation limits
- P Sample pH Not In Range
- RL Reporting Limit

QC SUMMARY REPORT

Hall Environmental Analysis Laboratory, Inc.

WO#: 2312185

15-Jan-24

Client: EA Engineering
Project: Del Oro Dairy

Sample ID: MB-79642	SampType: MBLK	TestCode: EPA 351.2: TKN								
Client ID: PBW	Batch ID: 79642	RunNo: 102166								
Prep Date: 12/28/2023	Analysis Date: 12/29/2023	SeqNo: 3771614	Units: mg/L							
Analyte	Result	PQL	SPK value	SPK Ref Val	%REC	LowLimit	HighLimit	%RPD	RPDLimit	Qual
Nitrogen, Kjeldahl, Total	ND	0.50								

Sample ID: LCSLL-79642	SampType: LCSLL	TestCode: EPA 351.2: TKN								
Client ID: BatchQC	Batch ID: 79642	RunNo: 102166								
Prep Date: 12/28/2023	Analysis Date: 12/29/2023	SeqNo: 3771615	Units: mg/L							
Analyte	Result	PQL	SPK value	SPK Ref Val	%REC	LowLimit	HighLimit	%RPD	RPDLimit	Qual
Nitrogen, Kjeldahl, Total	0.34	0	0.5000	0	68.9	50	150			

Sample ID: LCS-79642	SampType: LCS	TestCode: EPA 351.2: TKN								
Client ID: LCSW	Batch ID: 79642	RunNo: 102166								
Prep Date: 12/28/2023	Analysis Date: 12/29/2023	SeqNo: 3771616	Units: mg/L							
Analyte	Result	PQL	SPK value	SPK Ref Val	%REC	LowLimit	HighLimit	%RPD	RPDLimit	Qual
Nitrogen, Kjeldahl, Total	11	0.50	10.00	0	107	90	110			

Qualifiers:

- * Value exceeds Maximum Contaminant Level.
- D Sample Diluted Due to Matrix
- H Holding times for preparation or analysis exceeded
- ND Not Detected at the Reporting Limit
- PQL Practical Quantitative Limit
- S % Recovery outside of standard limits. If undiluted results may be estimated.
- B Analyte detected in the associated Method Blank
- E Above Quantitation Range/Estimated Value
- J Analyte detected below quantitation limits
- P Sample pH Not In Range
- RL Reporting Limit

Client Name: EA Engineering Work Order Number: 2312185 RcptNo: 1

Received By: Juan Rojas 12/5/2023 8:55:00 AM *Juan Rojas*

Completed By: Cheyenne Cason 12/5/2023 9:47:57 AM *Cason*

Reviewed By: *JA 12-5-23*

Chain of Custody

1. Is Chain of Custody complete? Yes No Not Present
2. How was the sample delivered? FedEx

Log In

3. Was an attempt made to cool the samples? Yes No NA
4. Were all samples received at a temperature of >0° C to 6.0°C Yes No NA
5. Sample(s) in proper container(s)? Yes No Samples not frozen
6. Sufficient sample volume for indicated test(s)? Yes No
7. Are samples (except VOA and ONG) properly preserved? Yes No
8. Was preservative added to bottles? Yes No NA
9. Received at least 1 vial with headspace <1/4" for AQ VOA? Yes No NA
10. Were any sample containers received broken? Yes No
11. Does paperwork match bottle labels? Yes No
 (Note discrepancies on chain of custody)
12. Are matrices correctly identified on Chain of Custody? Yes No
13. Is it clear what analyses were requested? Yes No
14. Were all holding times able to be met? Yes No
 (If no, notify customer for authorization.)

of preserved bottles checked for pH: 3
 (2 or >12 unless noted)
 Adjusted? NO
 Checked by: m/12/5/23

Special Handling (if applicable)

15. Was client notified of all discrepancies with this order? Yes No NA

Person Notified: Date:

By Whom: Via: eMail Phone Fax In Person

Regarding:

Client Instructions:

16. Additional remarks:

17. Cooler Information

Cooler No	Temp °C	Condition	Seal Intact	Seal No	Seal Date	Signed By
1	-0.7	Good	Not Present	Yogi		

January 15, 2024

Regina Mullen
EA Engineering
320 Gold Ave SW Suite 1210
Albuquerque, NM 87102
TEL:
FAX:

RE: Dona Ana Dairies

OrderNo.: 2312305

Dear Regina Mullen:

Eurofins Environment Testing South Central, LLC received 4 sample(s) on 12/6/2023 for the analyses presented in the following report.

These were analyzed according to EPA procedures or equivalent. To access our accredited tests please go to www.hallenvironmental.com or the state specific web sites. In order to properly interpret your results, it is imperative that you review this report in its entirety. See the sample checklist and/or the Chain of Custody for information regarding the sample receipt temperature and preservation. Data qualifiers or a narrative will be provided if the sample analysis or analytical quality control parameters require a flag. When necessary, data qualifiers are provided on both the sample analysis report and the QC summary report, both sections should be reviewed. All samples are reported, as received, unless otherwise indicated. Lab measurement of analytes considered field parameters that require analysis within 15 minutes of sampling such as pH and residual chlorine are qualified as being analyzed outside of the recommended holding time.

Please do not hesitate to contact Eurofins Albuquerque for any additional information or clarifications.

ADHS Cert #AZ0682 -- NMED-DWB Cert #NM9425 -- NMED-Micro Cert #NM0901

Sincerely,



Andy Freeman
Laboratory Manager
4901 Hawkins NE
Albuquerque, NM 87109

Hall Environmental Analysis Laboratory, Inc.

Analytical Report

Lab Order 2312305

Date Reported: 1/15/2024

CLIENT: EA Engineering

Client Sample ID: DAD-01

Project: Dona Ana Dairies

Collection Date: 12/5/2023 9:25:00 AM

Lab ID: 2312305-001

Matrix: GROUNDWA

Received Date: 12/6/2023 9:47:00 AM

Analyses	Result	RL	Qual	Units	DF	Date Analyzed
EPA METHOD 300.0: ANIONS						Analyst: JMT
Chloride	360	50	*	mg/L	100	12/9/2023 5:48:01 PM
Nitrate+Nitrite as N	11	1.0	*	mg/L	5	12/9/2023 8:34:46 PM
SM2540C MOD: TOTAL DISSOLVED SOLIDS						Analyst: KS
Total Dissolved Solids	1450	250	*D	mg/L	1	12/12/2023 5:15:00 PM
EPA 351.2: TKN						Analyst: DML
Nitrogen, Kjeldahl, Total	ND	0.50		mg/L	1	12/29/2023 5:07:52 PM

Refer to the QC Summary report and sample login checklist for flagged QC data and preservation information.

Qualifiers:	*	Value exceeds Maximum Contaminant Level.	B	Analyte detected in the associated Method Blank
	D	Sample Diluted Due to Matrix	E	Above Quantitation Range/Estimated Value
	H	Holding times for preparation or analysis exceeded	J	Analyte detected below quantitation limits
	ND	Not Detected at the Reporting Limit	P	Sample pH Not In Range
	PQL	Practical Quantitative Limit	RL	Reporting Limit
	S	% Recovery outside of standard limits. If undiluted results may be estimated.		

Hall Environmental Analysis Laboratory, Inc.

Analytical Report

Lab Order 2312305

Date Reported: 1/15/2024

CLIENT: EA Engineering

Client Sample ID: DAD-12

Project: Dona Ana Dairies

Collection Date: 12/5/2023 10:50:00 AM

Lab ID: 2312305-002

Matrix: GROUNDWA

Received Date: 12/6/2023 9:47:00 AM

Analyses	Result	RL	Qual	Units	DF	Date Analyzed
EPA METHOD 300.0: ANIONS						Analyst: JMT
Chloride	810	50	*	mg/L	100	12/9/2023 6:18:57 PM
Nitrate+Nitrite as N	10	1.0	*	mg/L	5	12/9/2023 8:49:55 PM
SM2540C MOD: TOTAL DISSOLVED SOLIDS						Analyst: KS
Total Dissolved Solids	3070	50.0	*	mg/L	1	12/12/2023 5:15:00 PM
EPA 351.2: TKN						Analyst: DML
Nitrogen, Kjeldahl, Total	0.53	0.50		mg/L	1	12/29/2023 5:12:22 PM

Refer to the QC Summary report and sample login checklist for flagged QC data and preservation information.

Qualifiers:	*	Value exceeds Maximum Contaminant Level.	B	Analyte detected in the associated Method Blank
	D	Sample Diluted Due to Matrix	E	Above Quantitation Range/Estimated Value
	H	Holding times for preparation or analysis exceeded	J	Analyte detected below quantitation limits
	ND	Not Detected at the Reporting Limit	P	Sample pH Not In Range
	PQL	Practical Quantitative Limit	RL	Reporting Limit
	S	% Recovery outside of standard limits. If undiluted results may be estimated.		

Hall Environmental Analysis Laboratory, Inc.

Analytical Report

Lab Order 2312305

Date Reported: 1/15/2024

CLIENT: EA Engineering

Client Sample ID: DAD-14

Project: Dona Ana Dairies

Collection Date: 12/5/2023 12:54:00 PM

Lab ID: 2312305-003

Matrix: GROUNDWA

Received Date: 12/6/2023 9:47:00 AM

Analyses	Result	RL	Qual	Units	DF	Date Analyzed
EPA METHOD 300.0: ANIONS						Analyst: JMT
Chloride	1400	50	*	mg/L	100	12/9/2023 6:48:43 PM
Nitrate+Nitrite as N	84	4.0	*	mg/L	20	12/15/2023 8:08:39 PM
SM2540C MOD: TOTAL DISSOLVED SOLIDS						Analyst: KS
Total Dissolved Solids	4050	100	*D	mg/L	1	12/12/2023 5:15:00 PM
EPA 351.2: TKN						Analyst: DML
Nitrogen, Kjeldahl, Total	ND	0.50		mg/L	1	12/29/2023 5:13:52 PM

Refer to the QC Summary report and sample login checklist for flagged QC data and preservation information.

Qualifiers:	*	Value exceeds Maximum Contaminant Level.	B	Analyte detected in the associated Method Blank
	D	Sample Diluted Due to Matrix	E	Above Quantitation Range/Estimated Value
	H	Holding times for preparation or analysis exceeded	J	Analyte detected below quantitation limits
	ND	Not Detected at the Reporting Limit	P	Sample pH Not In Range
	PQL	Practical Quantitative Limit	RL	Reporting Limit
	S	% Recovery outside of standard limits. If undiluted results may be estimated.		

Hall Environmental Analysis Laboratory, Inc.

Analytical Report

Lab Order 2312305

Date Reported: 1/15/2024

CLIENT: EA Engineering

Client Sample ID: DAD-13

Project: Dona Ana Dairies

Collection Date: 12/5/2023 2:46:00 PM

Lab ID: 2312305-004

Matrix: GROUNDWA

Received Date: 12/6/2023 9:47:00 AM

Analyses	Result	RL	Qual	Units	DF	Date Analyzed
EPA METHOD 300.0: ANIONS						Analyst: JMT
Chloride	850	50	*	mg/L	100	12/9/2023 7:18:59 PM
Nitrate+Nitrite as N	26	1.0	*	mg/L	5	12/9/2023 9:20:15 PM
SM2540C MOD: TOTAL DISSOLVED SOLIDS						Analyst: KS
Total Dissolved Solids	2650	100	*D	mg/L	1	12/12/2023 5:15:00 PM
EPA 351.2: TKN						Analyst: DML
Nitrogen, Kjeldahl, Total	ND	0.50		mg/L	1	12/29/2023 5:15:22 PM

Refer to the QC Summary report and sample login checklist for flagged QC data and preservation information.

Qualifiers:	*	Value exceeds Maximum Contaminant Level.	B	Analyte detected in the associated Method Blank
	D	Sample Diluted Due to Matrix	E	Above Quantitation Range/Estimated Value
	H	Holding times for preparation or analysis exceeded	J	Analyte detected below quantitation limits
	ND	Not Detected at the Reporting Limit	P	Sample pH Not In Range
	PQL	Practical Quantitative Limit	RL	Reporting Limit
	S	% Recovery outside of standard limits. If undiluted results may be estimated.		

QC SUMMARY REPORT

Hall Environmental Analysis Laboratory, Inc.

WO#: 2312305

15-Jan-24

Client: EA Engineering
Project: Dona Ana Dairies

Sample ID: MB	SampType: mblk	TestCode: EPA Method 300.0: Anions								
Client ID: PBW	Batch ID: R101742	RunNo: 101742								
Prep Date:	Analysis Date: 12/9/2023	SeqNo: 3749435			Units: mg/L					
Analyte	Result	PQL	SPK value	SPK Ref Val	%REC	LowLimit	HighLimit	%RPD	RPDLimit	Qual
Chloride	ND	0.50								
Nitrate+Nitrite as N	ND	0.20								

Sample ID: LCS	SampType: lcs	TestCode: EPA Method 300.0: Anions								
Client ID: LCSW	Batch ID: R101742	RunNo: 101742								
Prep Date:	Analysis Date: 12/9/2023	SeqNo: 3749436			Units: mg/L					
Analyte	Result	PQL	SPK value	SPK Ref Val	%REC	LowLimit	HighLimit	%RPD	RPDLimit	Qual
Chloride	4.7	0.50	5.000	0	93.4	90	110			
Nitrate+Nitrite as N	3.4	0.20	3.500	0	97.3	90	110			

Sample ID: MB	SampType: MBLK	TestCode: EPA Method 300.0: Anions								
Client ID: PBW	Batch ID: R101873	RunNo: 101873								
Prep Date:	Analysis Date: 12/15/2023	SeqNo: 3756389			Units: mg/L					
Analyte	Result	PQL	SPK value	SPK Ref Val	%REC	LowLimit	HighLimit	%RPD	RPDLimit	Qual
Nitrate+Nitrite as N	ND	0.20								

Sample ID: LCS	SampType: LCS	TestCode: EPA Method 300.0: Anions								
Client ID: LCSW	Batch ID: R101873	RunNo: 101873								
Prep Date:	Analysis Date: 12/15/2023	SeqNo: 3756390			Units: mg/L					
Analyte	Result	PQL	SPK value	SPK Ref Val	%REC	LowLimit	HighLimit	%RPD	RPDLimit	Qual
Nitrate+Nitrite as N	3.6	0.20	3.500	0	102	90	110			

Sample ID: MB	SampType: MBLK	TestCode: EPA Method 300.0: Anions								
Client ID: PBW	Batch ID: R101873	RunNo: 101873								
Prep Date:	Analysis Date: 12/15/2023	SeqNo: 3756424			Units: mg/L					
Analyte	Result	PQL	SPK value	SPK Ref Val	%REC	LowLimit	HighLimit	%RPD	RPDLimit	Qual
Nitrate+Nitrite as N	ND	0.20								

Sample ID: LCS	SampType: LCS	TestCode: EPA Method 300.0: Anions								
Client ID: LCSW	Batch ID: R101873	RunNo: 101873								
Prep Date:	Analysis Date: 12/15/2023	SeqNo: 3756425			Units: mg/L					
Analyte	Result	PQL	SPK value	SPK Ref Val	%REC	LowLimit	HighLimit	%RPD	RPDLimit	Qual
Nitrate+Nitrite as N	3.5	0.20	3.500	0	101	90	110			

Qualifiers:

- * Value exceeds Maximum Contaminant Level.
- D Sample Diluted Due to Matrix
- H Holding times for preparation or analysis exceeded
- ND Not Detected at the Reporting Limit
- PQL Practical Quantitative Limit
- S % Recovery outside of standard limits. If undiluted results may be estimated.
- B Analyte detected in the associated Method Blank
- E Above Quantitation Range/Estimated Value
- J Analyte detected below quantitation limits
- P Sample pH Not In Range
- RL Reporting Limit

QC SUMMARY REPORT

Hall Environmental Analysis Laboratory, Inc.

WO#: 2312305

15-Jan-24

Client: EA Engineering
Project: Dona Ana Dairies

Sample ID: MB	SampType: MBLK	TestCode: EPA Method 300.0: Anions								
Client ID: PBW	Batch ID: R101873	RunNo: 101873								
Prep Date:	Analysis Date: 12/15/2023	SeqNo: 3756452	Units: mg/L							
Analyte	Result	PQL	SPK value	SPK Ref Val	%REC	LowLimit	HighLimit	%RPD	RPDLimit	Qual
Nitrate+Nitrite as N	ND	0.20								

Sample ID: LCS	SampType: LCS	TestCode: EPA Method 300.0: Anions								
Client ID: LCSW	Batch ID: R101873	RunNo: 101873								
Prep Date:	Analysis Date: 12/15/2023	SeqNo: 3756453	Units: mg/L							
Analyte	Result	PQL	SPK value	SPK Ref Val	%REC	LowLimit	HighLimit	%RPD	RPDLimit	Qual
Nitrate+Nitrite as N	3.6	0.20	3.500	0	102	90	110			

Qualifiers:

- * Value exceeds Maximum Contaminant Level.
- D Sample Diluted Due to Matrix
- H Holding times for preparation or analysis exceeded
- ND Not Detected at the Reporting Limit
- PQL Practical Quantitative Limit
- S % Recovery outside of standard limits. If undiluted results may be estimated.
- B Analyte detected in the associated Method Blank
- E Above Quantitation Range/Estimated Value
- J Analyte detected below quantitation limits
- P Sample pH Not In Range
- RL Reporting Limit

QC SUMMARY REPORT

Hall Environmental Analysis Laboratory, Inc.

WO#: 2312305

15-Jan-24

Client: EA Engineering
Project: Dona Ana Dairies

Sample ID: MB-79282	SampType: MBLK	TestCode: SM2540C MOD: Total Dissolved Solids								
Client ID: PBW	Batch ID: 79282	RunNo: 101787								
Prep Date: 12/11/2023	Analysis Date: 12/12/2023	SeqNo: 3751455	Units: mg/L							
Analyte	Result	PQL	SPK value	SPK Ref Val	%REC	LowLimit	HighLimit	%RPD	RPDLimit	Qual
Total Dissolved Solids	ND	50.0								

Sample ID: LCS-79282	SampType: LCS	TestCode: SM2540C MOD: Total Dissolved Solids								
Client ID: LCSW	Batch ID: 79282	RunNo: 101787								
Prep Date: 12/11/2023	Analysis Date: 12/12/2023	SeqNo: 3751456	Units: mg/L							
Analyte	Result	PQL	SPK value	SPK Ref Val	%REC	LowLimit	HighLimit	%RPD	RPDLimit	Qual
Total Dissolved Solids	995	50.0	1000	0	99.5	80	120			

Qualifiers:

- * Value exceeds Maximum Contaminant Level.
- D Sample Diluted Due to Matrix
- H Holding times for preparation or analysis exceeded
- ND Not Detected at the Reporting Limit
- PQL Practical Quantitative Limit
- S % Recovery outside of standard limits. If undiluted results may be estimated.
- B Analyte detected in the associated Method Blank
- E Above Quantitation Range/Estimated Value
- J Analyte detected below quantitation limits
- P Sample pH Not In Range
- RL Reporting Limit

QC SUMMARY REPORT

Hall Environmental Analysis Laboratory, Inc.

WO#: 2312305

15-Jan-24

Client: EA Engineering
Project: Dona Ana Dairies

Sample ID: MB-79643	SampType: MBLK	TestCode: EPA 351.2: TKN								
Client ID: PBW	Batch ID: 79643	RunNo: 102166								
Prep Date: 12/28/2023	Analysis Date: 12/29/2023	SeqNo: 3771647	Units: mg/L							
Analyte	Result	PQL	SPK value	SPK Ref Val	%REC	LowLimit	HighLimit	%RPD	RPDLimit	Qual
Nitrogen, Kjeldahl, Total	ND	0.50								

Sample ID: LCS-79643	SampType: LCS	TestCode: EPA 351.2: TKN								
Client ID: LCSW	Batch ID: 79643	RunNo: 102166								
Prep Date: 12/28/2023	Analysis Date: 12/29/2023	SeqNo: 3771649	Units: mg/L							
Analyte	Result	PQL	SPK value	SPK Ref Val	%REC	LowLimit	HighLimit	%RPD	RPDLimit	Qual
Nitrogen, Kjeldahl, Total	11	0.50	10.00	0	107	90	110			

Sample ID: 2312305-001AMS	SampType: MS	TestCode: EPA 351.2: TKN								
Client ID: DAD-01	Batch ID: 79643	RunNo: 102166								
Prep Date: 12/28/2023	Analysis Date: 12/29/2023	SeqNo: 3771651	Units: mg/L							
Analyte	Result	PQL	SPK value	SPK Ref Val	%REC	LowLimit	HighLimit	%RPD	RPDLimit	Qual
Nitrogen, Kjeldahl, Total	6.4	0.50	10.00	0	63.7	90	110			S

Sample ID: 2312305-001AMSD	SampType: MSD	TestCode: EPA 351.2: TKN								
Client ID: DAD-01	Batch ID: 79643	RunNo: 102166								
Prep Date: 12/28/2023	Analysis Date: 12/29/2023	SeqNo: 3771652	Units: mg/L							
Analyte	Result	PQL	SPK value	SPK Ref Val	%REC	LowLimit	HighLimit	%RPD	RPDLimit	Qual
Nitrogen, Kjeldahl, Total	7.1	0.50	10.00	0	71.1	90	110	10.9	0	S

Qualifiers:

- * Value exceeds Maximum Contaminant Level.
- D Sample Diluted Due to Matrix
- H Holding times for preparation or analysis exceeded
- ND Not Detected at the Reporting Limit
- PQL Practical Quantitative Limit
- S % Recovery outside of standard limits. If undiluted results may be estimated.
- B Analyte detected in the associated Method Blank
- E Above Quantitation Range/Estimated Value
- J Analyte detected below quantitation limits
- P Sample pH Not In Range
- RL Reporting Limit

Client Name: EA Engineering Work Order Number: 2312305 RcptNo: 1

Received By: Joseph Alderette 12/6/2023 9:47:00 AM

Completed By: Desiree Dominguez 12/6/2023 12:47:33 PM

Reviewed By: *JD* *JD*

Chain of Custody

1. Is Chain of Custody complete? Yes No Not Present
2. How was the sample delivered? FedEx

Log In

3. Was an attempt made to cool the samples? Yes No NA
4. Were all samples received at a temperature of >0° C to 6.0°C Yes No NA
5. Sample(s) in proper container(s)? Yes No
6. Sufficient sample volume for indicated test(s)? Yes No
7. Are samples (except VOA and ONG) properly preserved? Yes No
8. Was preservative added to bottles? Yes No NA
9. Received at least 1 vial with headspace <1/4" for AQ VOA? Yes No NA
10. Were any sample containers received broken? Yes No
11. Does paperwork match bottle labels?
(Note discrepancies on chain of custody) Yes No
12. Are matrices correctly identified on Chain of Custody? Yes No
13. Is it clear what analyses were requested? Yes No
14. Were all holding times able to be met?
(If no, notify customer for authorization.) Yes No

of preserved bottles checked for pH: 4
(2 or >12 unless noted)

Adjusted? NO

Checked by: SCM 12/6/23

Special Handling (if applicable)

15. Was client notified of all discrepancies with this order? Yes No NA

Person Notified: _____ Date: _____

By Whom: _____ Via: eMail Phone Fax In Person

Regarding: _____

Client Instructions: _____

16. Additional remarks:

17. Cooler Information

Cooler No	Temp °C	Condition	Seal Intact	Seal No	Seal Date	Signed By
1	1.2	Good	Not Present	Yogi		

January 18, 2024

Regina Mullen
EA Engineering
320 Gold Ave SW Suite 1210
Albuquerque, NM 87102
TEL:
FAX:

RE: Dona Ana Dairies

OrderNo.: 2312414

Dear Regina Mullen:

Eurofins Environment Testing South Central, LLC received 3 sample(s) on 12/7/2023 for the analyses presented in the following report.

These were analyzed according to EPA procedures or equivalent. To access our accredited tests please go to www.hallenvironmental.com or the state specific web sites. In order to properly interpret your results, it is imperative that you review this report in its entirety. See the sample checklist and/or the Chain of Custody for information regarding the sample receipt temperature and preservation. Data qualifiers or a narrative will be provided if the sample analysis or analytical quality control parameters require a flag. When necessary, data qualifiers are provided on both the sample analysis report and the QC summary report, both sections should be reviewed. All samples are reported, as received, unless otherwise indicated. Lab measurement of analytes considered field parameters that require analysis within 15 minutes of sampling such as pH and residual chlorine are qualified as being analyzed outside of the recommended holding time.

Please do not hesitate to contact Eurofins Albuquerque for any additional information or clarifications.

ADHS Cert #AZ0682 -- NMED-DWB Cert #NM9425 -- NMED-Micro Cert #NM0901

Sincerely,



Andy Freeman
Laboratory Manager
4901 Hawkins NE
Albuquerque, NM 87109

Hall Environmental Analysis Laboratory, Inc.

Analytical Report

Lab Order 2312414

Date Reported: 1/18/2024

CLIENT: EA Engineering

Client Sample ID: DAD-11

Project: Dona Ana Dairies

Collection Date: 12/6/2023 12:20:00 PM

Lab ID: 2312414-001

Matrix: GROUNDWA

Received Date: 12/7/2023 9:35:00 AM

Analyses	Result	RL	Qual	Units	DF	Date Analyzed
EPA METHOD 300.0: ANIONS						Analyst: SNS
Chloride	1000	50	*	mg/L	100	12/8/2023 2:20:06 AM
Nitrogen, Nitrite (As N)	ND	1.0		mg/L	10	12/8/2023 2:07:14 AM
Nitrogen, Nitrate (As N)	31	1.0	*	mg/L	10	12/8/2023 2:07:14 AM
SM2540C MOD: TOTAL DISSOLVED SOLIDS						Analyst: KS
Total Dissolved Solids	3490	100	*D	mg/L	1	12/14/2023 6:49:00 PM
EPA 351.2: TKN						Analyst: DML
Nitrogen, Kjeldahl, Total	ND	0.50	H	mg/L	1	1/10/2024 2:02:22 PM

Refer to the QC Summary report and sample login checklist for flagged QC data and preservation information.

Qualifiers:	*	Value exceeds Maximum Contaminant Level.	B	Analyte detected in the associated Method Blank
	D	Sample Diluted Due to Matrix	E	Above Quantitation Range/Estimated Value
	H	Holding times for preparation or analysis exceeded	J	Analyte detected below quantitation limits
	ND	Not Detected at the Reporting Limit	P	Sample pH Not In Range
	PQL	Practical Quantitative Limit	RL	Reporting Limit
	S	% Recovery outside of standard limits. If undiluted results may be estimated.		

Hall Environmental Analysis Laboratory, Inc.

Analytical Report

Lab Order 2312414

Date Reported: 1/18/2024

CLIENT: EA Engineering

Client Sample ID: DAD-23

Project: Dona Ana Dairies

Collection Date: 12/6/2023 2:00:00 PM

Lab ID: 2312414-002

Matrix: GROUNDWA

Received Date: 12/7/2023 9:35:00 AM

Analyses	Result	RL	Qual	Units	DF	Date Analyzed
EPA METHOD 300.0: ANIONS						Analyst: SNS
Chloride	270	50	*	mg/L	100	12/8/2023 2:45:42 AM
Nitrogen, Nitrite (As N)	ND	1.0		mg/L	10	12/8/2023 2:32:51 AM
Nitrogen, Nitrate (As N)	17	1.0	*	mg/L	10	12/8/2023 2:32:51 AM
SM2540C MOD: TOTAL DISSOLVED SOLIDS						Analyst: KS
Total Dissolved Solids	1490	100	*D	mg/L	1	12/14/2023 6:49:00 PM
EPA 351.2: TKN						Analyst: DML
Nitrogen, Kjeldahl, Total	ND	0.50	H	mg/L	1	1/10/2024 2:03:52 PM

Refer to the QC Summary report and sample login checklist for flagged QC data and preservation information.

Qualifiers:	*	Value exceeds Maximum Contaminant Level.	B	Analyte detected in the associated Method Blank
	D	Sample Diluted Due to Matrix	E	Above Quantitation Range/Estimated Value
	H	Holding times for preparation or analysis exceeded	J	Analyte detected below quantitation limits
	ND	Not Detected at the Reporting Limit	P	Sample pH Not In Range
	PQL	Practical Quantitative Limit	RL	Reporting Limit
	S	% Recovery outside of standard limits. If undiluted results may be estimated.		

Hall Environmental Analysis Laboratory, Inc.

Analytical Report

Lab Order 2312414

Date Reported: 1/18/2024

CLIENT: EA Engineering

Client Sample ID: DAD-02

Project: Dona Ana Dairies

Collection Date: 12/6/2023 3:36:00 PM

Lab ID: 2312414-003

Matrix: GROUNDWA

Received Date: 12/7/2023 9:35:00 AM

Analyses	Result	RL	Qual	Units	DF	Date Analyzed
EPA METHOD 300.0: ANIONS						Analyst: SNS
Chloride	670	50	*	mg/L	100	12/8/2023 3:12:20 AM
Nitrogen, Nitrite (As N)	ND	1.0		mg/L	10	12/8/2023 2:58:34 AM
Nitrogen, Nitrate (As N)	6.5	1.0		mg/L	10	12/8/2023 2:58:34 AM
SM2540C MOD: TOTAL DISSOLVED SOLIDS						Analyst: KS
Total Dissolved Solids	2290	500	*D	mg/L	1	12/14/2023 6:49:00 PM
EPA 351.2: TKN						Analyst: DML
Nitrogen, Kjeldahl, Total	ND	2.5	H, D	mg/L	1	1/10/2024 2:05:22 PM

Refer to the QC Summary report and sample login checklist for flagged QC data and preservation information.

Qualifiers:	*	Value exceeds Maximum Contaminant Level.	B	Analyte detected in the associated Method Blank
	D	Sample Diluted Due to Matrix	E	Above Quantitation Range/Estimated Value
	H	Holding times for preparation or analysis exceeded	J	Analyte detected below quantitation limits
	ND	Not Detected at the Reporting Limit	P	Sample pH Not In Range
	PQL	Practical Quantitative Limit	RL	Reporting Limit
	S	% Recovery outside of standard limits. If undiluted results may be estimated.		

QC SUMMARY REPORT

Hall Environmental Analysis Laboratory, Inc.

WO#: 2312414

18-Jan-24

Client: EA Engineering
Project: Dona Ana Dairies

Sample ID: MB	SampType: MBLK	TestCode: EPA Method 300.0: Anions								
Client ID: PBW	Batch ID: A101699	RunNo: 101699								
Prep Date:	Analysis Date: 12/7/2023	SeqNo: 3747127			Units: mg/L					
Analyte	Result	PQL	SPK value	SPK Ref Val	%REC	LowLimit	HighLimit	%RPD	RPDLimit	Qual
Chloride	ND	0.50								
Nitrogen, Nitrite (As N)	ND	0.10								
Nitrogen, Nitrate (As N)	ND	0.10								

Sample ID: LCS	SampType: LCS	TestCode: EPA Method 300.0: Anions								
Client ID: LCSW	Batch ID: A101699	RunNo: 101699								
Prep Date:	Analysis Date: 12/7/2023	SeqNo: 3747128			Units: mg/L					
Analyte	Result	PQL	SPK value	SPK Ref Val	%REC	LowLimit	HighLimit	%RPD	RPDLimit	Qual
Chloride	4.8	0.50	5.000	0	95.2	90	110			
Nitrogen, Nitrite (As N)	0.98	0.10	1.000	0	98.3	90	110			
Nitrogen, Nitrate (As N)	2.5	0.10	2.500	0	99.6	90	110			

Qualifiers:

- * Value exceeds Maximum Contaminant Level.
- D Sample Diluted Due to Matrix
- H Holding times for preparation or analysis exceeded
- ND Not Detected at the Reporting Limit
- PQL Practical Quantitative Limit
- S % Recovery outside of standard limits. If undiluted results may be estimated.
- B Analyte detected in the associated Method Blank
- E Above Quantitation Range/Estimated Value
- J Analyte detected below quantitation limits
- P Sample pH Not In Range
- RL Reporting Limit

QC SUMMARY REPORT

Hall Environmental Analysis Laboratory, Inc.

WO#: 2312414

18-Jan-24

Client: EA Engineering
Project: Dona Ana Dairies

Sample ID: MB-79342	SampType: MBLK	TestCode: SM2540C MOD: Total Dissolved Solids								
Client ID: PBW	Batch ID: 79342	RunNo: 101845								
Prep Date: 12/13/2023	Analysis Date: 12/14/2023	SeqNo: 3754949	Units: mg/L							
Analyte	Result	PQL	SPK value	SPK Ref Val	%REC	LowLimit	HighLimit	%RPD	RPDLimit	Qual
Total Dissolved Solids	ND	50.0								

Sample ID: LCS-79342	SampType: LCS	TestCode: SM2540C MOD: Total Dissolved Solids								
Client ID: LCSW	Batch ID: 79342	RunNo: 101845								
Prep Date: 12/13/2023	Analysis Date: 12/14/2023	SeqNo: 3754950	Units: mg/L							
Analyte	Result	PQL	SPK value	SPK Ref Val	%REC	LowLimit	HighLimit	%RPD	RPDLimit	Qual
Total Dissolved Solids	1010	50.0	1000	0	101	80	120			

Qualifiers:

- * Value exceeds Maximum Contaminant Level.
- D Sample Diluted Due to Matrix
- H Holding times for preparation or analysis exceeded
- ND Not Detected at the Reporting Limit
- PQL Practical Quantitative Limit
- S % Recovery outside of standard limits. If undiluted results may be estimated.
- B Analyte detected in the associated Method Blank
- E Above Quantitation Range/Estimated Value
- J Analyte detected below quantitation limits
- P Sample pH Not In Range
- RL Reporting Limit

QC SUMMARY REPORT

Hall Environmental Analysis Laboratory, Inc.

WO#: 2312414

18-Jan-24

Client: EA Engineering
Project: Dona Ana Dairies

Sample ID: MB-79797	SampType: MBLK	TestCode: EPA 351.2: TKN								
Client ID: PBW	Batch ID: 79797	RunNo: 102361								
Prep Date: 1/9/2024	Analysis Date: 1/10/2024	SeqNo: 3780020	Units: mg/L							
Analyte	Result	PQL	SPK value	SPK Ref Val	%REC	LowLimit	HighLimit	%RPD	RPDLimit	Qual
Nitrogen, Kjeldahl, Total	ND	0.50								

Sample ID: LCS-79797	SampType: LCS	TestCode: EPA 351.2: TKN								
Client ID: LCSW	Batch ID: 79797	RunNo: 102361								
Prep Date: 1/9/2024	Analysis Date: 1/10/2024	SeqNo: 3780022	Units: mg/L							
Analyte	Result	PQL	SPK value	SPK Ref Val	%REC	LowLimit	HighLimit	%RPD	RPDLimit	Qual
Nitrogen, Kjeldahl, Total	10	0.50	10.00	0	103	90	110			

Qualifiers:

- * Value exceeds Maximum Contaminant Level.
- D Sample Diluted Due to Matrix
- H Holding times for preparation or analysis exceeded
- ND Not Detected at the Reporting Limit
- PQL Practical Quantitative Limit
- S % Recovery outside of standard limits. If undiluted results may be estimated.
- B Analyte detected in the associated Method Blank
- E Above Quantitation Range/Estimated Value
- J Analyte detected below quantitation limits
- P Sample pH Not In Range
- RL Reporting Limit

Sample Log-In Check List

Client Name: EA Engineering

Work Order Number: 2312414

RcptNo: 1

Received By: Desiree Dominguez

12/7/2023 9:35:00 AM

DD

Completed By: Cheyenne Cason

12/7/2023 11:27:50 AM

CC

Reviewed By: *mc 12/7/23*

Chain of Custody

1. Is Chain of Custody complete? Yes No Not Present
 2. How was the sample delivered? Client FedEx 12/7/23

Log In

3. Was an attempt made to cool the samples? Yes No NA
 4. Were all samples received at a temperature of >0° C to 6.0°C Yes No NA
 5. Sample(s) in proper container(s)? Yes No
 6. Sufficient sample volume for indicated test(s)? Yes No
 7. Are samples (except VOA and ONG) properly preserved? Yes No
 8. Was preservative added to bottles? Yes No NA
 9. Received at least 1 vial with headspace <1/4" for AQ VOA? Yes No NA
 10. Were any sample containers received broken? Yes No
 11. Does paperwork match bottle labels? Yes No
 (Note discrepancies on chain of custody)
 12. Are matrices correctly identified on Chain of Custody? Yes No
 13. Is it clear what analyses were requested? Yes No
 14. Were all holding times able to be met? Yes No
 (If no, notify customer for authorization.)

of preserved bottles checked for pH: 3
 (≤ or >12 unless noted)
 Adjusted? No
 Checked by: *mc 12/07/23*

Special Handling (if applicable)

15. Was client notified of all discrepancies with this order? Yes No NA

Person Notified: _____ Date: _____
 By Whom: _____ Via: eMail Phone Fax In Person
 Regarding: _____
 Client Instructions: _____

16. Additional remarks:

17. Cooler Information

Cooler No	Temp °C	Condition	Seal Intact	Seal No	Seal Date	Signed By
1	0.5	Good	Not Present	Morty		

January 16, 2024

Regina Mullen
EA Engineering
320 Gold Ave SW Suite 1210
Albuquerque, NM 87102
TEL:
FAX:

RE: Dona Ana Dairies

OrderNo.: 2312520

Dear Regina Mullen:

Eurofins Environment Testing South Central, LLC received 3 sample(s) on 12/8/2023 for the analyses presented in the following report.

These were analyzed according to EPA procedures or equivalent. To access our accredited tests please go to www.hallenvironmental.com or the state specific web sites. In order to properly interpret your results, it is imperative that you review this report in its entirety. See the sample checklist and/or the Chain of Custody for information regarding the sample receipt temperature and preservation. Data qualifiers or a narrative will be provided if the sample analysis or analytical quality control parameters require a flag. When necessary, data qualifiers are provided on both the sample analysis report and the QC summary report, both sections should be reviewed. All samples are reported, as received, unless otherwise indicated. Lab measurement of analytes considered field parameters that require analysis within 15 minutes of sampling such as pH and residual chlorine are qualified as being analyzed outside of the recommended holding time.

Please do not hesitate to contact Eurofins Albuquerque for any additional information or clarifications.

ADHS Cert #AZ0682 -- NMED-DWB Cert #NM9425 -- NMED-Micro Cert #NM0901

Sincerely,



Andy Freeman
Laboratory Manager
4901 Hawkins NE
Albuquerque, NM 87109

Hall Environmental Analysis Laboratory, Inc.

Analytical Report

Lab Order 2312520

Date Reported: 1/16/2024

CLIENT: EA Engineering

Client Sample ID: DAD-03

Project: Dona Ana Dairies

Collection Date: 12/7/2023 11:10:00 AM

Lab ID: 2312520-001

Matrix: GROUNDWA

Received Date: 12/8/2023 8:35:00 AM

Analyses	Result	RL	Qual	Units	DF	Date Analyzed
EPA METHOD 300.0: ANIONS						Analyst: JTT
Chloride	310	50	*	mg/L	100	12/8/2023 2:10:37 PM
Nitrogen, Nitrite (As N)	ND	1.0		mg/L	10	12/8/2023 1:56:16 PM
Nitrogen, Nitrate (As N)	ND	1.0		mg/L	10	12/8/2023 1:56:16 PM
SM2540C MOD: TOTAL DISSOLVED SOLIDS						Analyst: KS
Total Dissolved Solids	1580	250	*D	mg/L	1	12/19/2023 9:19:00 AM
EPA 351.2: TKN						Analyst: DML
Nitrogen, Kjeldahl, Total	1.3	0.50	H	mg/L	1	1/8/2024 5:00:00 PM

Refer to the QC Summary report and sample login checklist for flagged QC data and preservation information.

Qualifiers:	*	Value exceeds Maximum Contaminant Level.	B	Analyte detected in the associated Method Blank
	D	Sample Diluted Due to Matrix	E	Above Quantitation Range/Estimated Value
	H	Holding times for preparation or analysis exceeded	J	Analyte detected below quantitation limits
	ND	Not Detected at the Reporting Limit	P	Sample pH Not In Range
	PQL	Practical Quantitative Limit	RL	Reporting Limit
	S	% Recovery outside of standard limits. If undiluted results may be estimated.		

Hall Environmental Analysis Laboratory, Inc.

Analytical Report

Lab Order 2312520

Date Reported: 1/16/2024

CLIENT: EA Engineering

Client Sample ID: DAD-04

Project: Dona Ana Dairies

Collection Date: 12/7/2023 12:36:00 PM

Lab ID: 2312520-002

Matrix: GROUNDWA

Received Date: 12/8/2023 8:35:00 AM

Analyses	Result	RL	Qual	Units	DF	Date Analyzed
EPA METHOD 300.0: ANIONS						Analyst: JTT
Chloride	410	50	*	mg/L	100	12/8/2023 3:02:01 PM
Nitrogen, Nitrite (As N)	ND	1.0		mg/L	10	12/8/2023 2:49:09 PM
Nitrogen, Nitrate (As N)	ND	1.0		mg/L	10	12/8/2023 2:49:09 PM
SM2540C MOD: TOTAL DISSOLVED SOLIDS						Analyst: KS
Total Dissolved Solids	2130	250	*D	mg/L	1	12/19/2023 9:19:00 AM
EPA 351.2: TKN						Analyst: DML
Nitrogen, Kjeldahl, Total	0.75	0.50	H	mg/L	1	1/8/2024 5:02:00 PM

Refer to the QC Summary report and sample login checklist for flagged QC data and preservation information.

Qualifiers:	*	Value exceeds Maximum Contaminant Level.	B	Analyte detected in the associated Method Blank
	D	Sample Diluted Due to Matrix	E	Above Quantitation Range/Estimated Value
	H	Holding times for preparation or analysis exceeded	J	Analyte detected below quantitation limits
	ND	Not Detected at the Reporting Limit	P	Sample pH Not In Range
	PQL	Practical Quantitative Limit	RL	Reporting Limit
	S	% Recovery outside of standard limits. If undiluted results may be estimated.		

Hall Environmental Analysis Laboratory, Inc.

Analytical Report

Lab Order 2312520

Date Reported: 1/16/2024

CLIENT: EA Engineering

Client Sample ID: DAD-16

Project: Dona Ana Dairies

Collection Date: 12/7/2023 2:47:00 PM

Lab ID: 2312520-003

Matrix: GROUNDWA

Received Date: 12/8/2023 8:35:00 AM

Analyses	Result	RL	Qual	Units	DF	Date Analyzed
EPA METHOD 300.0: ANIONS						Analyst: JTT
Chloride	280	50	*	mg/L	100	12/8/2023 3:27:45 PM
Nitrogen, Nitrite (As N)	ND	1.0		mg/L	10	12/8/2023 3:14:52 PM
Nitrogen, Nitrate (As N)	1.1	1.0		mg/L	10	12/8/2023 3:14:52 PM
SM2540C MOD: TOTAL DISSOLVED SOLIDS						Analyst: KS
Total Dissolved Solids	1640	100	*D	mg/L	1	12/19/2023 9:19:00 AM
EPA 351.2: TKN						Analyst: DML
Nitrogen, Kjeldahl, Total	0.73	0.50	H	mg/L	1	1/8/2024 5:06:00 PM

Refer to the QC Summary report and sample login checklist for flagged QC data and preservation information.

Qualifiers:	*	Value exceeds Maximum Contaminant Level.	B	Analyte detected in the associated Method Blank
	D	Sample Diluted Due to Matrix	E	Above Quantitation Range/Estimated Value
	H	Holding times for preparation or analysis exceeded	J	Analyte detected below quantitation limits
	ND	Not Detected at the Reporting Limit	P	Sample pH Not In Range
	PQL	Practical Quantitative Limit	RL	Reporting Limit
	S	% Recovery outside of standard limits. If undiluted results may be estimated.		

QC SUMMARY REPORT

Hall Environmental Analysis Laboratory, Inc.

WO#: 2312520

16-Jan-24

Client: EA Engineering
Project: Dona Ana Dairies

Sample ID: MB	SampType: MBLK	TestCode: EPA Method 300.0: Anions								
Client ID: PBW	Batch ID: R101717	RunNo: 101717								
Prep Date:	Analysis Date: 12/8/2023	SeqNo: 3747702			Units: mg/L					
Analyte	Result	PQL	SPK value	SPK Ref Val	%REC	LowLimit	HighLimit	%RPD	RPDLimit	Qual
Chloride	ND	0.50								
Nitrogen, Nitrite (As N)	ND	0.10								
Nitrogen, Nitrate (As N)	ND	0.10								

Sample ID: LCS	SampType: LCS	TestCode: EPA Method 300.0: Anions								
Client ID: LCSW	Batch ID: R101717	RunNo: 101717								
Prep Date:	Analysis Date: 12/8/2023	SeqNo: 3747703			Units: mg/L					
Analyte	Result	PQL	SPK value	SPK Ref Val	%REC	LowLimit	HighLimit	%RPD	RPDLimit	Qual
Chloride	4.8	0.50	5.000	0	96.4	90	110			
Nitrogen, Nitrite (As N)	0.99	0.10	1.000	0	99.3	90	110			
Nitrogen, Nitrate (As N)	2.5	0.10	2.500	0	102	90	110			

Qualifiers:

- * Value exceeds Maximum Contaminant Level.
- D Sample Diluted Due to Matrix
- H Holding times for preparation or analysis exceeded
- ND Not Detected at the Reporting Limit
- PQL Practical Quantitative Limit
- S % Recovery outside of standard limits. If undiluted results may be estimated.
- B Analyte detected in the associated Method Blank
- E Above Quantitation Range/Estimated Value
- J Analyte detected below quantitation limits
- P Sample pH Not In Range
- RL Reporting Limit

QC SUMMARY REPORT

Hall Environmental Analysis Laboratory, Inc.

WO#: 2312520

16-Jan-24

Client: EA Engineering
Project: Dona Ana Dairies

Sample ID: MB-79388	SampType: MBLK	TestCode: SM2540C MOD: Total Dissolved Solids								
Client ID: PBW	Batch ID: 79388	RunNo: 101931								
Prep Date: 12/14/2023	Analysis Date: 12/19/2023	SeqNo: 3760082	Units: mg/L							
Analyte	Result	PQL	SPK value	SPK Ref Val	%REC	LowLimit	HighLimit	%RPD	RPDLimit	Qual
Total Dissolved Solids	ND	50.0								

Sample ID: LCS-79388	SampType: LCS	TestCode: SM2540C MOD: Total Dissolved Solids								
Client ID: LCSW	Batch ID: 79388	RunNo: 101931								
Prep Date: 12/14/2023	Analysis Date: 12/19/2023	SeqNo: 3760083	Units: mg/L							
Analyte	Result	PQL	SPK value	SPK Ref Val	%REC	LowLimit	HighLimit	%RPD	RPDLimit	Qual
Total Dissolved Solids	1010	50.0	1000	0	101	80	120			

Qualifiers:

- * Value exceeds Maximum Contaminant Level.
- D Sample Diluted Due to Matrix
- H Holding times for preparation or analysis exceeded
- ND Not Detected at the Reporting Limit
- PQL Practical Quantitative Limit
- S % Recovery outside of standard limits. If undiluted results may be estimated.
- B Analyte detected in the associated Method Blank
- E Above Quantitation Range/Estimated Value
- J Analyte detected below quantitation limits
- P Sample pH Not In Range
- RL Reporting Limit

QC SUMMARY REPORT

Hall Environmental Analysis Laboratory, Inc.

WO#: 2312520

16-Jan-24

Client: EA Engineering
Project: Dona Ana Dairies

Sample ID: MB-79762	SampType: MBLK	TestCode: EPA 351.2: TKN								
Client ID: PBW	Batch ID: 79762	RunNo: 102360								
Prep Date: 1/6/2024	Analysis Date: 1/8/2024	SeqNo: 3783597	Units: mg/L							
Analyte	Result	PQL	SPK value	SPK Ref Val	%REC	LowLimit	HighLimit	%RPD	RPDLimit	Qual
Nitrogen, Kjeldahl, Total	ND	0.50								

Sample ID: LCS-79762	SampType: LCS	TestCode: EPA 351.2: TKN								
Client ID: LCSW	Batch ID: 79762	RunNo: 102360								
Prep Date: 1/6/2024	Analysis Date: 1/8/2024	SeqNo: 3783601	Units: mg/L							
Analyte	Result	PQL	SPK value	SPK Ref Val	%REC	LowLimit	HighLimit	%RPD	RPDLimit	Qual
Nitrogen, Kjeldahl, Total	10	0.50	10.00	0	101	90	110			

Qualifiers:

- | | |
|---|---|
| * Value exceeds Maximum Contaminant Level. | B Analyte detected in the associated Method Blank |
| D Sample Diluted Due to Matrix | E Above Quantitation Range/Estimated Value |
| H Holding times for preparation or analysis exceeded | J Analyte detected below quantitation limits |
| ND Not Detected at the Reporting Limit | P Sample pH Not In Range |
| PQL Practical Quantitative Limit | RL Reporting Limit |
| S % Recovery outside of standard limits. If undiluted results may be estimated. | |

Sample Log-In Check List

Client Name: **EA Engineering** Work Order Number: **2312520** RcptNo: **1**

Received By: **Joseph Alderette** 12/8/2023 8:35:00 AM

Completed By: **Desiree Dominguez** 12/8/2023 9:20:29 AM

Reviewed By: *JA 12/8/23*

Chain of Custody

1. Is Chain of Custody complete? Yes No Not Present
2. How was the sample delivered? Client

Log In

3. Was an attempt made to cool the samples? Yes No NA
4. Were all samples received at a temperature of >0° C to 6.0°C Yes No NA
5. Sample(s) in proper container(s)? Yes No
6. Sufficient sample volume for indicated test(s)? Yes No
7. Are samples (except VOA and ONG) properly preserved? Yes No
8. Was preservative added to bottles? Yes No NA
9. Received at least 1 vial with headspace <1/4" for AQ VOA? Yes No NA
10. Were any sample containers received broken? Yes No
11. Does paperwork match bottle labels?
(Note discrepancies on chain of custody) Yes No
12. Are matrices correctly identified on Chain of Custody? Yes No
13. Is it clear what analyses were requested? Yes No
14. Were all holding times able to be met?
(If no, notify customer for authorization.) Yes No

of preserved bottles checked for pH: 3
(~~0~~ or >12 unless noted)

Adjusted? NO

Checked by: *JA 12-8-23*

Special Handling (if applicable)

15. Was client notified of all discrepancies with this order? Yes No NA

Person Notified:	<input type="text"/>	Date:	<input type="text"/>
By Whom:	<input type="text"/>	Via:	<input type="checkbox"/> eMail <input type="checkbox"/> Phone <input type="checkbox"/> Fax <input type="checkbox"/> In Person
Regarding:	<input type="text"/>		
Client Instructions:	<input type="text"/>		

16. Additional remarks:

17. Cooler Information

Cooler No	Temp °C	Condition	Seal Intact	Seal No	Seal Date	Signed By
1	0.7	Good	Not Present	Yogi		

January 22, 2024

Regina Mullen
EA Engineering
320 Gold Ave SW Suite 1210
Albuquerque, NM 87102
TEL:
FAX:

RE: Dona Ana Dairies DADS

OrderNo.: 2312765

Dear Regina Mullen:

Eurofins Environment Testing South Central, LLC received 3 sample(s) on 12/13/2023 for the analyses presented in the following report.

These were analyzed according to EPA procedures or equivalent. To access our accredited tests please go to www.hallenvironmental.com or the state specific web sites. In order to properly interpret your results, it is imperative that you review this report in its entirety. See the sample checklist and/or the Chain of Custody for information regarding the sample receipt temperature and preservation. Data qualifiers or a narrative will be provided if the sample analysis or analytical quality control parameters require a flag. When necessary, data qualifiers are provided on both the sample analysis report and the QC summary report, both sections should be reviewed. All samples are reported, as received, unless otherwise indicated. Lab measurement of analytes considered field parameters that require analysis within 15 minutes of sampling such as pH and residual chlorine are qualified as being analyzed outside of the recommended holding time.

Please do not hesitate to contact Eurofins Albuquerque for any additional information or clarifications.

ADHS Cert #AZ0682 -- NMED-DWB Cert #NM9425 -- NMED-Micro Cert #NM0901

Sincerely,



Andy Freeman
Laboratory Manager
4901 Hawkins NE
Albuquerque, NM 87109

Hall Environmental Analysis Laboratory, Inc.

Analytical Report

Lab Order 2312765

Date Reported: 1/22/2024

CLIENT: EA Engineering

Client Sample ID: DAD-19

Project: Dona Ana Dairies DADS

Collection Date: 12/12/2023 10:40:00 AM

Lab ID: 2312765-001

Matrix: GROUNDWA

Received Date: 12/13/2023 9:20:00 AM

Analyses	Result	RL	Qual	Units	DF	Date Analyzed
EPA METHOD 300.0: ANIONS						Analyst: JMT
Chloride	1000	50	*	mg/L	100	12/13/2023 10:38:47 PM
Nitrogen, Nitrite (As N)	ND	1.0		mg/L	10	12/13/2023 10:26:23 PM
Nitrogen, Nitrate (As N)	30	1.0	*	mg/L	10	12/13/2023 10:26:23 PM
SM2540C MOD: TOTAL DISSOLVED SOLIDS						Analyst: KS
Total Dissolved Solids	3070	50.0	*	mg/L	1	12/21/2023 10:22:00 AM
EPA 351.2: TKN						Analyst: DML
Nitrogen, Kjeldahl, Total	ND	2.5	H, D	mg/L	1	1/16/2024 4:44:20 PM

Refer to the QC Summary report and sample login checklist for flagged QC data and preservation information.

Qualifiers:

- * Value exceeds Maximum Contaminant Level.
- D Sample Diluted Due to Matrix
- H Holding times for preparation or analysis exceeded
- ND Not Detected at the Reporting Limit
- PQL Practical Quantitative Limit
- S % Recovery outside of standard limits. If undiluted results may be estimated.

- B Analyte detected in the associated Method Blank
- E Above Quantitation Range/Estimated Value
- J Analyte detected below quantitation limits
- P Sample pH Not In Range
- RL Reporting Limit

Hall Environmental Analysis Laboratory, Inc.

Analytical Report

Lab Order 2312765

Date Reported: 1/22/2024

CLIENT: EA Engineering

Client Sample ID: DAD-17

Project: Dona Ana Dairies DADS

Collection Date: 12/12/2023 11:52:00 AM

Lab ID: 2312765-002

Matrix: GROUNDWA

Received Date: 12/13/2023 9:20:00 AM

Analyses	Result	RL	Qual	Units	DF	Date Analyzed
EPA METHOD 300.0: ANIONS						Analyst: JMT
Chloride	100	5.0		mg/L	10	12/13/2023 10:51:12 PM
Nitrogen, Nitrite (As N)	ND	1.0		mg/L	10	12/13/2023 10:51:12 PM
Nitrogen, Nitrate (As N)	ND	1.0		mg/L	10	12/13/2023 10:51:12 PM
SM2540C MOD: TOTAL DISSOLVED SOLIDS						Analyst: KS
Total Dissolved Solids	750	100	*D	mg/L	1	12/21/2023 10:22:00 AM
EPA 351.2: TKN						Analyst: DML
Nitrogen, Kjeldahl, Total	ND	0.50	H	mg/L	1	1/16/2024 4:45:50 PM

Refer to the QC Summary report and sample login checklist for flagged QC data and preservation information.

Qualifiers:

- | | | | |
|-----|---|----|---|
| * | Value exceeds Maximum Contaminant Level. | B | Analyte detected in the associated Method Blank |
| D | Sample Diluted Due to Matrix | E | Above Quantitation Range/Estimated Value |
| H | Holding times for preparation or analysis exceeded | J | Analyte detected below quantitation limits |
| ND | Not Detected at the Reporting Limit | P | Sample pH Not In Range |
| PQL | Practical Quantitative Limit | RL | Reporting Limit |
| S | % Recovery outside of standard limits. If undiluted results may be estimated. | | |

Hall Environmental Analysis Laboratory, Inc.

Analytical Report

Lab Order 2312765

Date Reported: 1/22/2024

CLIENT: EA Engineering

Client Sample ID: DAD-05

Project: Dona Ana Dairies DADS

Collection Date: 12/12/2023 3:30:00 PM

Lab ID: 2312765-003

Matrix: GROUNDWA

Received Date: 12/13/2023 9:20:00 AM

Analyses	Result	RL	Qual	Units	DF	Date Analyzed
EPA METHOD 300.0: ANIONS						Analyst: JMT
Chloride	180	50		mg/L	100	12/13/2023 11:28:25 PM
Nitrogen, Nitrite (As N)	ND	1.0		mg/L	10	12/13/2023 11:16:00 PM
Nitrogen, Nitrate (As N)	ND	1.0		mg/L	10	12/13/2023 11:16:00 PM
SM2540C MOD: TOTAL DISSOLVED SOLIDS						Analyst: KS
Total Dissolved Solids	1180	250	*D	mg/L	1	12/21/2023 10:22:00 AM
EPA 351.2: TKN						Analyst: DML
Nitrogen, Kjeldahl, Total	3.8	1.2	H, D	mg/L	1	1/16/2024 4:47:20 PM

Refer to the QC Summary report and sample login checklist for flagged QC data and preservation information.

Qualifiers:	*	Value exceeds Maximum Contaminant Level.	B	Analyte detected in the associated Method Blank
	D	Sample Diluted Due to Matrix	E	Above Quantitation Range/Estimated Value
	H	Holding times for preparation or analysis exceeded	J	Analyte detected below quantitation limits
	ND	Not Detected at the Reporting Limit	P	Sample pH Not In Range
	PQL	Practical Quantitative Limit	RL	Reporting Limit
	S	% Recovery outside of standard limits. If undiluted results may be estimated.		

QC SUMMARY REPORT

Hall Environmental Analysis Laboratory, Inc.

WO#: 2312765

22-Jan-24

Client: EA Engineering
Project: Dona Ana Dairies DADS

Sample ID: MB	SampType: mblk	TestCode: EPA Method 300.0: Anions								
Client ID: PBW	Batch ID: R101819	RunNo: 101819								
Prep Date:	Analysis Date: 12/13/2023	SeqNo: 3753650	Units: mg/L							
Analyte	Result	PQL	SPK value	SPK Ref Val	%REC	LowLimit	HighLimit	%RPD	RPDLimit	Qual
Chloride	ND	0.50								
Nitrogen, Nitrite (As N)	ND	0.10								
Nitrogen, Nitrate (As N)	ND	0.10								

Sample ID: LCS	SampType: lcs	TestCode: EPA Method 300.0: Anions								
Client ID: LCSW	Batch ID: R101819	RunNo: 101819								
Prep Date:	Analysis Date: 12/13/2023	SeqNo: 3753651	Units: mg/L							
Analyte	Result	PQL	SPK value	SPK Ref Val	%REC	LowLimit	HighLimit	%RPD	RPDLimit	Qual
Chloride	4.6	0.50	5.000	0	92.4	90	110			
Nitrogen, Nitrite (As N)	0.94	0.10	1.000	0	93.7	90	110			
Nitrogen, Nitrate (As N)	2.4	0.10	2.500	0	95.2	90	110			

Qualifiers:

- * Value exceeds Maximum Contaminant Level.
- D Sample Diluted Due to Matrix
- H Holding times for preparation or analysis exceeded
- ND Not Detected at the Reporting Limit
- PQL Practical Quantitative Limit
- S % Recovery outside of standard limits. If undiluted results may be estimated.
- B Analyte detected in the associated Method Blank
- E Above Quantitation Range/Estimated Value
- J Analyte detected below quantitation limits
- P Sample pH Not In Range
- RL Reporting Limit

QC SUMMARY REPORT

Hall Environmental Analysis Laboratory, Inc.

WO#: 2312765

22-Jan-24

Client: EA Engineering
Project: Dona Ana Dairies DADS

Sample ID: MB-79489	SampType: MBLK	TestCode: SM2540C MOD: Total Dissolved Solids								
Client ID: PBW	Batch ID: 79489	RunNo: 102003								
Prep Date: 12/19/2023	Analysis Date: 12/21/2023	SeqNo: 3763783	Units: mg/L							
Analyte	Result	PQL	SPK value	SPK Ref Val	%REC	LowLimit	HighLimit	%RPD	RPDLimit	Qual
Total Dissolved Solids	ND	50.0								

Sample ID: LCS-79489	SampType: LCS	TestCode: SM2540C MOD: Total Dissolved Solids								
Client ID: LCSW	Batch ID: 79489	RunNo: 102003								
Prep Date: 12/19/2023	Analysis Date: 12/21/2023	SeqNo: 3763784	Units: mg/L							
Analyte	Result	PQL	SPK value	SPK Ref Val	%REC	LowLimit	HighLimit	%RPD	RPDLimit	Qual
Total Dissolved Solids	1010	50.0	1000	0	101	80	120			

Qualifiers:

- * Value exceeds Maximum Contaminant Level.
- D Sample Diluted Due to Matrix
- H Holding times for preparation or analysis exceeded
- ND Not Detected at the Reporting Limit
- PQL Practical Quantitative Limit
- S % Recovery outside of standard limits. If undiluted results may be estimated.
- B Analyte detected in the associated Method Blank
- E Above Quantitation Range/Estimated Value
- J Analyte detected below quantitation limits
- P Sample pH Not In Range
- RL Reporting Limit

QC SUMMARY REPORT

Hall Environmental Analysis Laboratory, Inc.

WO#: 2312765

22-Jan-24

Client: EA Engineering
Project: Dona Ana Dairies DADS

Sample ID: MB-79892	SampType: MBLK	TestCode: EPA 351.2: TKN								
Client ID: PBW	Batch ID: 79892	RunNo: 102467								
Prep Date: 1/14/2024	Analysis Date: 1/16/2024	SeqNo: 3785117	Units: mg/L							
Analyte	Result	PQL	SPK value	SPK Ref Val	%REC	LowLimit	HighLimit	%RPD	RPDLimit	Qual
Nitrogen, Kjeldahl, Total	ND	0.50								

Sample ID: LCS-79892	SampType: LCS	TestCode: EPA 351.2: TKN								
Client ID: LCSW	Batch ID: 79892	RunNo: 102467								
Prep Date: 1/14/2024	Analysis Date: 1/16/2024	SeqNo: 3785119	Units: mg/L							
Analyte	Result	PQL	SPK value	SPK Ref Val	%REC	LowLimit	HighLimit	%RPD	RPDLimit	Qual
Nitrogen, Kjeldahl, Total	10	0.50	10.00	0	104	90	110			

Qualifiers:

- * Value exceeds Maximum Contaminant Level.
- D Sample Diluted Due to Matrix
- H Holding times for preparation or analysis exceeded
- ND Not Detected at the Reporting Limit
- PQL Practical Quantitative Limit
- S % Recovery outside of standard limits. If undiluted results may be estimated.
- B Analyte detected in the associated Method Blank
- E Above Quantitation Range/Estimated Value
- J Analyte detected below quantitation limits
- P Sample pH Not In Range
- RL Reporting Limit

Sample Log-In Check List

Client Name: **EA Engineering** Work Order Number: **2312765** RcptNo: **1**

Received By: **Joseph Alderette** 12/13/2023 9:20:00 AM *JA*

Completed By: **Cheyenne Cason** 12/13/2023 11:44:28 AM *CC*

Reviewed By: *JW 12/13/23*

Chain of Custody

1. Is Chain of Custody complete? Yes No Not Present
2. How was the sample delivered? FedEx

Log In

3. Was an attempt made to cool the samples? Yes No NA
4. Were all samples received at a temperature of >0° C to 6.0°C Yes No NA
5. Sample(s) in proper container(s)? Yes No
6. Sufficient sample volume for indicated test(s)? Yes No
7. Are samples (except VOA and ONG) properly preserved? Yes No
8. Was preservative added to bottles? Yes No NA
9. Received at least 1 vial with headspace <1/4" for AQ VOA? Yes No NA
10. Were any sample containers received broken? Yes No
11. Does paperwork match bottle labels? Yes No
(Note discrepancies on chain of custody)
12. Are matrices correctly identified on Chain of Custody? Yes No
13. Is it clear what analyses were requested? Yes No
14. Were all holding times able to be met? Yes No
(If no, notify customer for authorization.)

of preserved bottles checked for pH: 3
(<2 or >12 unless noted)

Adjusted? No

Checked by: *JW 12/13/23*

Special Handling (if applicable)

15. Was client notified of all discrepancies with this order? Yes No NA

Person Notified:	_____	Date:	_____
By Whom:	_____	Via:	<input type="checkbox"/> eMail <input type="checkbox"/> Phone <input type="checkbox"/> Fax <input type="checkbox"/> In Person
Regarding:	_____		
Client Instructions:	_____		

16. Additional remarks:

17. Cooler Information

Cooler No	Temp °C	Condition	Seal Intact	Seal No	Seal Date	Signed By
1	0.3	Good	Not Present	Morty		

January 23, 2024

Regina Mullen
EA Engineering
320 Gold Ave SW Suite 1210
Albuquerque, NM 87102
TEL:
FAX:

RE: Dona Ana Dairies DADs

OrderNo.: 2312838

Dear Regina Mullen:

Eurofins Environment Testing South Central, LLC received 4 sample(s) on 12/14/2023 for the analyses presented in the following report.

These were analyzed according to EPA procedures or equivalent. To access our accredited tests please go to www.hallenvironmental.com or the state specific web sites. In order to properly interpret your results, it is imperative that you review this report in its entirety. See the sample checklist and/or the Chain of Custody for information regarding the sample receipt temperature and preservation. Data qualifiers or a narrative will be provided if the sample analysis or analytical quality control parameters require a flag. When necessary, data qualifiers are provided on both the sample analysis report and the QC summary report, both sections should be reviewed. All samples are reported, as received, unless otherwise indicated. Lab measurement of analytes considered field parameters that require analysis within 15 minutes of sampling such as pH and residual chlorine are qualified as being analyzed outside of the recommended holding time.

Please do not hesitate to contact Eurofins Albuquerque for any additional information or clarifications.

ADHS Cert #AZ0682 -- NMED-DWB Cert #NM9425 -- NMED-Micro Cert #NM0901

Sincerely,



Andy Freeman
Laboratory Manager
4901 Hawkins NE
Albuquerque, NM 87109

Hall Environmental Analysis Laboratory, Inc.

Analytical Report

Lab Order 2312838

Date Reported: 1/23/2024

CLIENT: EA Engineering

Client Sample ID: DAD-07

Project: Dona Ana Dairies DADs

Collection Date: 12/13/2023 10:35:00 AM

Lab ID: 2312838-001

Matrix: GROUNDWA

Received Date: 12/14/2023 8:40:00 AM

Analyses	Result	RL	Qual	Units	DF	Date Analyzed
EPA METHOD 300.0: ANIONS						Analyst: SNS
Chloride	720	50	*	mg/L	100	12/14/2023 2:32:13 PM
Nitrogen, Nitrite (As N)	ND	1.0		mg/L	10	12/14/2023 1:53:36 PM
Nitrogen, Nitrate (As N)	43	1.0	*	mg/L	10	12/14/2023 1:53:36 PM
SM2540C MOD: TOTAL DISSOLVED SOLIDS						Analyst: KS
Total Dissolved Solids	3220	100	*D	mg/L	1	12/21/2023 7:22:00 PM
EPA 351.2: TKN						Analyst: DML
Nitrogen, Kjeldahl, Total	ND	0.50	H	mg/L	1	1/19/2024 2:26:14 PM

Refer to the QC Summary report and sample login checklist for flagged QC data and preservation information.

Qualifiers:

- * Value exceeds Maximum Contaminant Level.
- D Sample Diluted Due to Matrix
- H Holding times for preparation or analysis exceeded
- ND Not Detected at the Reporting Limit
- PQL Practical Quantitative Limit
- S % Recovery outside of standard limits. If undiluted results may be estimated.

- B Analyte detected in the associated Method Blank
- E Above Quantitation Range/Estimated Value
- J Analyte detected below quantitation limits
- P Sample pH Not In Range
- RL Reporting Limit

Hall Environmental Analysis Laboratory, Inc.

Analytical Report

Lab Order 2312838

Date Reported: 1/23/2024

CLIENT: EA Engineering

Client Sample ID: DAD-18

Project: Dona Ana Dairies DADs

Collection Date: 12/13/2023 12:20:00 PM

Lab ID: 2312838-002

Matrix: GROUNDWA

Received Date: 12/14/2023 8:40:00 AM

Analyses	Result	RL	Qual	Units	DF	Date Analyzed
EPA METHOD 300.0: ANIONS						Analyst: SNS
Chloride	640	50	*	mg/L	100	12/14/2023 2:57:56 PM
Nitrogen, Nitrite (As N)	ND	1.0		mg/L	10	12/14/2023 2:45:04 PM
Nitrogen, Nitrate (As N)	10	1.0	*	mg/L	10	12/14/2023 2:45:04 PM
SM2540C MOD: TOTAL DISSOLVED SOLIDS						Analyst: KS
Total Dissolved Solids	2650	50.0	*	mg/L	1	12/21/2023 7:22:00 PM
EPA 351.2: TKN						Analyst: DML
Nitrogen, Kjeldahl, Total	0.84	0.50	H	mg/L	1	1/19/2024 2:30:44 PM

Refer to the QC Summary report and sample login checklist for flagged QC data and preservation information.

Qualifiers:	*	Value exceeds Maximum Contaminant Level.	B	Analyte detected in the associated Method Blank
	D	Sample Diluted Due to Matrix	E	Above Quantitation Range/Estimated Value
	H	Holding times for preparation or analysis exceeded	J	Analyte detected below quantitation limits
	ND	Not Detected at the Reporting Limit	P	Sample pH Not In Range
	PQL	Practical Quantitative Limit	RL	Reporting Limit
	S	% Recovery outside of standard limits. If undiluted results may be estimated.		

Hall Environmental Analysis Laboratory, Inc.

Analytical Report

Lab Order 2312838

Date Reported: 1/23/2024

CLIENT: EA Engineering

Client Sample ID: DAD-08

Project: Dona Ana Dairies DADs

Collection Date: 12/13/2023 2:26:00 PM

Lab ID: 2312838-003

Matrix: GROUNDWA

Received Date: 12/14/2023 8:40:00 AM

Analyses	Result	RL	Qual	Units	DF	Date Analyzed
EPA METHOD 300.0: ANIONS						Analyst: SNS
Chloride	1400	50	*	mg/L	100	12/14/2023 3:23:37 PM
Nitrogen, Nitrite (As N)	ND	1.0		mg/L	10	12/14/2023 3:10:44 PM
Nitrogen, Nitrate (As N)	42	1.0	*	mg/L	10	12/14/2023 3:10:44 PM
SM2540C MOD: TOTAL DISSOLVED SOLIDS						Analyst: KS
Total Dissolved Solids	4100	100	*D	mg/L	1	12/21/2023 7:22:00 PM
EPA 351.2: TKN						Analyst: DML
Nitrogen, Kjeldahl, Total	ND	2.5	HD	mg/L	1	1/19/2024 2:32:14 PM

Refer to the QC Summary report and sample login checklist for flagged QC data and preservation information.

Qualifiers:	*	Value exceeds Maximum Contaminant Level.	B	Analyte detected in the associated Method Blank
	D	Sample Diluted Due to Matrix	E	Above Quantitation Range/Estimated Value
	H	Holding times for preparation or analysis exceeded	J	Analyte detected below quantitation limits
	ND	Not Detected at the Reporting Limit	P	Sample pH Not In Range
	PQL	Practical Quantitative Limit	RL	Reporting Limit
	S	% Recovery outside of standard limits. If undiluted results may be estimated.		

Hall Environmental Analysis Laboratory, Inc.

Analytical Report

Lab Order 2312838

Date Reported: 1/23/2024

CLIENT: EA Engineering

Client Sample ID: DAD-25

Project: Dona Ana Dairies DADs

Collection Date: 12/13/2023 4:18:00 PM

Lab ID: 2312838-004

Matrix: GROUNDWA

Received Date: 12/14/2023 8:40:00 AM

Analyses	Result	RL	Qual	Units	DF	Date Analyzed
EPA METHOD 300.0: ANIONS						Analyst: SNS
Chloride	840	50	*	mg/L	100	12/14/2023 3:49:20 PM
Nitrogen, Nitrite (As N)	ND	1.0		mg/L	10	12/14/2023 3:36:29 PM
Nitrogen, Nitrate (As N)	8.4	1.0		mg/L	10	12/14/2023 3:36:29 PM
SM2540C MOD: TOTAL DISSOLVED SOLIDS						Analyst: KS
Total Dissolved Solids	2180	500	*D	mg/L	1	12/21/2023 7:22:00 PM
EPA 351.2: TKN						Analyst: DML
Nitrogen, Kjeldahl, Total	ND	2.5	HD	mg/L	1	1/19/2024 2:33:44 PM

Refer to the QC Summary report and sample login checklist for flagged QC data and preservation information.

Qualifiers:	*	Value exceeds Maximum Contaminant Level.	B	Analyte detected in the associated Method Blank
	D	Sample Diluted Due to Matrix	E	Above Quantitation Range/Estimated Value
	H	Holding times for preparation or analysis exceeded	J	Analyte detected below quantitation limits
	ND	Not Detected at the Reporting Limit	P	Sample pH Not In Range
	PQL	Practical Quantitative Limit	RL	Reporting Limit
	S	% Recovery outside of standard limits. If undiluted results may be estimated.		

QC SUMMARY REPORT

Hall Environmental Analysis Laboratory, Inc.

WO#: 2312838

23-Jan-24

Client: EA Engineering
Project: Dona Ana Dairies DADs

Sample ID: MB	SampType: MBLK	TestCode: EPA Method 300.0: Anions								
Client ID: PBW	Batch ID: R101854	RunNo: 101854								
Prep Date:	Analysis Date: 12/14/2023	SeqNo: 3755550			Units: mg/L					
Analyte	Result	PQL	SPK value	SPK Ref Val	%REC	LowLimit	HighLimit	%RPD	RPDLimit	Qual
Chloride	ND	0.50								
Nitrogen, Nitrite (As N)	ND	0.10								
Nitrogen, Nitrate (As N)	ND	0.10								

Sample ID: LCS	SampType: LCS	TestCode: EPA Method 300.0: Anions								
Client ID: LCSW	Batch ID: R101854	RunNo: 101854								
Prep Date:	Analysis Date: 12/14/2023	SeqNo: 3755551			Units: mg/L					
Analyte	Result	PQL	SPK value	SPK Ref Val	%REC	LowLimit	HighLimit	%RPD	RPDLimit	Qual
Chloride	4.7	0.50	5.000	0	93.2	90	110			
Nitrogen, Nitrite (As N)	0.96	0.10	1.000	0	96.2	90	110			
Nitrogen, Nitrate (As N)	2.4	0.10	2.500	0	97.6	90	110			

Sample ID: 2312838-001AMS	SampType: MS	TestCode: EPA Method 300.0: Anions								
Client ID: DAD-07	Batch ID: R101854	RunNo: 101854								
Prep Date:	Analysis Date: 12/14/2023	SeqNo: 3755573			Units: mg/L					
Analyte	Result	PQL	SPK value	SPK Ref Val	%REC	LowLimit	HighLimit	%RPD	RPDLimit	Qual
Nitrogen, Nitrite (As N)	9.5	1.0	10.00	0	94.6	80	120			
Nitrogen, Nitrate (As N)	70	1.0	25.00	43.25	108	80	120			

Sample ID: 2312838-001AMSD	SampType: MSD	TestCode: EPA Method 300.0: Anions								
Client ID: DAD-07	Batch ID: R101854	RunNo: 101854								
Prep Date:	Analysis Date: 12/14/2023	SeqNo: 3755574			Units: mg/L					
Analyte	Result	PQL	SPK value	SPK Ref Val	%REC	LowLimit	HighLimit	%RPD	RPDLimit	Qual
Nitrogen, Nitrite (As N)	9.6	1.0	10.00	0	95.5	80	120	1.01	20	
Nitrogen, Nitrate (As N)	69	1.0	25.00	43.25	105	80	120	1.23	20	

Qualifiers:

- * Value exceeds Maximum Contaminant Level.
- D Sample Diluted Due to Matrix
- H Holding times for preparation or analysis exceeded
- ND Not Detected at the Reporting Limit
- PQL Practical Quantitative Limit
- S % Recovery outside of standard limits. If undiluted results may be estimated.
- B Analyte detected in the associated Method Blank
- E Above Quantitation Range/Estimated Value
- J Analyte detected below quantitation limits
- P Sample pH Not In Range
- RL Reporting Limit

QC SUMMARY REPORT

Hall Environmental Analysis Laboratory, Inc.

WO#: 2312838

23-Jan-24

Client: EA Engineering
Project: Dona Ana Dairies DADs

Sample ID: MB-79518	SampType: MBLK	TestCode: SM2540C MOD: Total Dissolved Solids								
Client ID: PBW	Batch ID: 79518	RunNo: 102025								
Prep Date: 12/20/2023	Analysis Date: 12/21/2023	SeqNo: 3764700	Units: mg/L							
Analyte	Result	PQL	SPK value	SPK Ref Val	%REC	LowLimit	HighLimit	%RPD	RPDLimit	Qual
Total Dissolved Solids	ND	50.0								

Sample ID: LCS-79518	SampType: LCS	TestCode: SM2540C MOD: Total Dissolved Solids								
Client ID: LCSW	Batch ID: 79518	RunNo: 102025								
Prep Date: 12/20/2023	Analysis Date: 12/21/2023	SeqNo: 3764701	Units: mg/L							
Analyte	Result	PQL	SPK value	SPK Ref Val	%REC	LowLimit	HighLimit	%RPD	RPDLimit	Qual
Total Dissolved Solids	995	50.0	1000	0	99.5	80	120			

Qualifiers:

- * Value exceeds Maximum Contaminant Level.
- D Sample Diluted Due to Matrix
- H Holding times for preparation or analysis exceeded
- ND Not Detected at the Reporting Limit
- PQL Practical Quantitative Limit
- S % Recovery outside of standard limits. If undiluted results may be estimated.
- B Analyte detected in the associated Method Blank
- E Above Quantitation Range/Estimated Value
- J Analyte detected below quantitation limits
- P Sample pH Not In Range
- RL Reporting Limit

QC SUMMARY REPORT

Hall Environmental Analysis Laboratory, Inc.

WO#: 2312838

23-Jan-24

Client: EA Engineering
Project: Dona Ana Dairies DADs

Sample ID: MB-79983	SampType: MBLK	TestCode: EPA 351.2: TKN								
Client ID: PBW	Batch ID: 79983	RunNo: 102583								
Prep Date: 1/18/2024	Analysis Date: 1/19/2024	SeqNo: 3789705	Units: mg/L							
Analyte	Result	PQL	SPK value	SPK Ref Val	%REC	LowLimit	HighLimit	%RPD	RPDLimit	Qual
Nitrogen, Kjeldahl, Total	ND	0.50								

Sample ID: LCS-79983	SampType: LCS	TestCode: EPA 351.2: TKN								
Client ID: LCSW	Batch ID: 79983	RunNo: 102583								
Prep Date: 1/18/2024	Analysis Date: 1/19/2024	SeqNo: 3789707	Units: mg/L							
Analyte	Result	PQL	SPK value	SPK Ref Val	%REC	LowLimit	HighLimit	%RPD	RPDLimit	Qual
Nitrogen, Kjeldahl, Total	9.9	0.50	10.00	0	99.0	90	110			

Sample ID: 2312838-001AMS	SampType: MS	TestCode: EPA 351.2: TKN								
Client ID: DAD-07	Batch ID: 79983	RunNo: 102583								
Prep Date: 1/18/2024	Analysis Date: 1/19/2024	SeqNo: 3789709	Units: mg/L							
Analyte	Result	PQL	SPK value	SPK Ref Val	%REC	LowLimit	HighLimit	%RPD	RPDLimit	Qual
Nitrogen, Kjeldahl, Total	1.3	0.50	10.00	0	12.7	90	110			SH

Sample ID: 2312838-001AMSD	SampType: MSD	TestCode: EPA 351.2: TKN								
Client ID: DAD-07	Batch ID: 79983	RunNo: 102583								
Prep Date: 1/18/2024	Analysis Date: 1/19/2024	SeqNo: 3789710	Units: mg/L							
Analyte	Result	PQL	SPK value	SPK Ref Val	%REC	LowLimit	HighLimit	%RPD	RPDLimit	Qual
Nitrogen, Kjeldahl, Total	2.2	0.50	10.00	0	21.7	90	110	52.4	20	RSH

Qualifiers:

- * Value exceeds Maximum Contaminant Level.
- D Sample Diluted Due to Matrix
- H Holding times for preparation or analysis exceeded
- ND Not Detected at the Reporting Limit
- PQL Practical Quantitative Limit
- S % Recovery outside of standard limits. If undiluted results may be estimated.
- B Analyte detected in the associated Method Blank
- E Above Quantitation Range/Estimated Value
- J Analyte detected below quantitation limits
- P Sample pH Not In Range
- RL Reporting Limit

Sample Log-In Check List

Client Name: EA Engineering

Work Order Number: 2312838

RcptNo: 1

Received By: Desiree Dominguez

12/14/2023 8:40:00 AM

Completed By: Desiree Dominguez

12/14/2023 9:36:05 AM

Reviewed By:

12/14/23

Chain of Custody

1. Is Chain of Custody complete? Yes No Not Present

2. How was the sample delivered? FedEx

Log In

3. Was an attempt made to cool the samples? Yes No NA

4. Were all samples received at a temperature of >0° C to 6.0° C? Yes No NA

5. Sample(s) in proper container(s)? Yes No

6. Sufficient sample volume for indicated test(s)? Yes No

7. Are samples (except VOA and ONG) properly preserved? Yes No

8. Was preservative added to bottles? Yes No NA

9. Received at least 1 vial with headspace <1/4" for AQ VOA? Yes No NA

10. Were any sample containers received broken? Yes No

11. Does paperwork match bottle labels?
 (Note discrepancies on chain of custody) Yes No

12. Are matrices correctly identified on Chain of Custody? Yes No

13. Is it clear what analyses were requested? Yes No

14. Were all holding times able to be met?
 (If no, notify customer for authorization.) Yes No

of preserved bottles checked for pH: 4
 (2 or >12 unless noted)
 Adjusted? NO
 Checked by: Ju 12/14/23

Special Handling (if applicable)

15. Was client notified of all discrepancies with this order? Yes No NA

Person Notified:	<input type="text"/>	Date:	<input type="text"/>
By Whom:	<input type="text"/>	Via:	<input type="checkbox"/> eMail <input type="checkbox"/> Phone <input type="checkbox"/> Fax <input type="checkbox"/> In Person
Regarding:	<input type="text"/>		
Client Instructions:	<input type="text"/>		

16. Additional remarks:

17. Cooler Information

Cooler No	Temp °C	Condition	Seal Intact	Seal No	Seal Date	Signed By
1	3.9	Good	Not Present	Yogi		

January 22, 2024

Regina Mullen
EA Engineering
320 Gold Ave SW Suite 1210
Albuquerque, NM 87102
TEL:
FAX:

RE: Dona Ana Dairies DADs

OrderNo.: 2312922

Dear Regina Mullen:

Eurofins Environment Testing South Central, LLC received 5 sample(s) on 12/15/2023 for the analyses presented in the following report.

These were analyzed according to EPA procedures or equivalent. To access our accredited tests please go to www.hallenvironmental.com or the state specific web sites. In order to properly interpret your results, it is imperative that you review this report in its entirety. See the sample checklist and/or the Chain of Custody for information regarding the sample receipt temperature and preservation. Data qualifiers or a narrative will be provided if the sample analysis or analytical quality control parameters require a flag. When necessary, data qualifiers are provided on both the sample analysis report and the QC summary report, both sections should be reviewed. All samples are reported, as received, unless otherwise indicated. Lab measurement of analytes considered field parameters that require analysis within 15 minutes of sampling such as pH and residual chlorine are qualified as being analyzed outside of the recommended holding time.

Please do not hesitate to contact Eurofins Albuquerque for any additional information or clarifications.

ADHS Cert #AZ0682 -- NMED-DWB Cert #NM9425 -- NMED-Micro Cert #NM0901

Sincerely,



Andy Freeman
Laboratory Manager
4901 Hawkins NE
Albuquerque, NM 87109

Hall Environmental Analysis Laboratory, Inc.

Analytical Report

Lab Order 2312922

Date Reported: 1/22/2024

CLIENT: EA Engineering

Client Sample ID: DAD-10

Project: Dona Ana Dairies DADs

Collection Date: 12/14/2023 10:18:00 AM

Lab ID: 2312922-001

Matrix: GROUNDWA

Received Date: 12/15/2023 9:30:00 AM

Analyses	Result	RL	Qual	Units	DF	Date Analyzed
EPA METHOD 300.0: ANIONS						Analyst: JTT
Chloride	380	50	*	mg/L	100	12/15/2023 5:59:12 PM
Nitrogen, Nitrite (As N)	ND	1.0		mg/L	10	12/15/2023 5:46:22 PM
Nitrogen, Nitrate (As N)	1.1	1.0		mg/L	10	12/15/2023 5:46:22 PM
SM2540C MOD: TOTAL DISSOLVED SOLIDS						Analyst: KS
Total Dissolved Solids	1450	250	*D	mg/L	1	12/22/2023 11:46:00 AM
EPA 351.2: TKN						Analyst: MRA
Nitrogen, Kjeldahl, Total	ND	2.5	HD	mg/L	1	1/13/2024 3:13:57 PM

Refer to the QC Summary report and sample login checklist for flagged QC data and preservation information.

Qualifiers:	*	Value exceeds Maximum Contaminant Level.	B	Analyte detected in the associated Method Blank
	D	Sample Diluted Due to Matrix	E	Above Quantitation Range/Estimated Value
	H	Holding times for preparation or analysis exceeded	J	Analyte detected below quantitation limits
	ND	Not Detected at the Reporting Limit	P	Sample pH Not In Range
	PQL	Practical Quantitative Limit	RL	Reporting Limit
	S	% Recovery outside of standard limits. If undiluted results may be estimated.		

Hall Environmental Analysis Laboratory, Inc.

Analytical Report

Lab Order 2312922

Date Reported: 1/22/2024

CLIENT: EA Engineering

Client Sample ID: DAD-21

Project: Dona Ana Dairies DADs

Collection Date: 12/14/2023 12:31:00 PM

Lab ID: 2312922-002

Matrix: GROUNDWA

Received Date: 12/15/2023 9:30:00 AM

Analyses	Result	RL	Qual	Units	DF	Date Analyzed
EPA METHOD 300.0: ANIONS						Analyst: JTT
Chloride	660	50	*	mg/L	100	12/15/2023 6:53:11 PM
Nitrogen, Nitrite (As N)	ND	1.0		mg/L	10	12/15/2023 6:12:03 PM
Nitrogen, Nitrate (As N)	28	1.0	*	mg/L	10	12/15/2023 6:12:03 PM
SM2540C MOD: TOTAL DISSOLVED SOLIDS						Analyst: KS
Total Dissolved Solids	2430	100	*D	mg/L	1	12/22/2023 11:46:00 AM
EPA 351.2: TKN						Analyst: MRA
Nitrogen, Kjeldahl, Total	ND	0.50	H	mg/L	1	1/13/2024 3:15:27 PM

Refer to the QC Summary report and sample login checklist for flagged QC data and preservation information.

Qualifiers:	*	Value exceeds Maximum Contaminant Level.	B	Analyte detected in the associated Method Blank
	D	Sample Diluted Due to Matrix	E	Above Quantitation Range/Estimated Value
	H	Holding times for preparation or analysis exceeded	J	Analyte detected below quantitation limits
	ND	Not Detected at the Reporting Limit	P	Sample pH Not In Range
	PQL	Practical Quantitative Limit	RL	Reporting Limit
	S	% Recovery outside of standard limits. If undiluted results may be estimated.		

Hall Environmental Analysis Laboratory, Inc.

Analytical Report

Lab Order 2312922

Date Reported: 1/22/2024

CLIENT: EA Engineering

Client Sample ID: DAD-09

Project: Dona Ana Dairies DADs

Collection Date: 12/14/2023 2:00:00 PM

Lab ID: 2312922-003

Matrix: GROUNDWA

Received Date: 12/15/2023 9:30:00 AM

Analyses	Result	RL	Qual	Units	DF	Date Analyzed
EPA METHOD 300.0: ANIONS						Analyst: JTT
Chloride	430	50	*	mg/L	100	12/15/2023 7:44:36 PM
Nitrogen, Nitrite (As N)	ND	1.0		mg/L	10	12/15/2023 7:31:44 PM
Nitrogen, Nitrate (As N)	33	1.0	*	mg/L	10	12/15/2023 7:31:44 PM
SM2540C MOD: TOTAL DISSOLVED SOLIDS						Analyst: KS
Total Dissolved Solids	1860	250	*D	mg/L	1	12/22/2023 11:46:00 AM
EPA 351.2: TKN						Analyst: MRA
Nitrogen, Kjeldahl, Total	ND	0.50		mg/L	1	1/13/2024 3:19:57 PM

Refer to the QC Summary report and sample login checklist for flagged QC data and preservation information.

Qualifiers:	*	Value exceeds Maximum Contaminant Level.	B	Analyte detected in the associated Method Blank
	D	Sample Diluted Due to Matrix	E	Above Quantitation Range/Estimated Value
	H	Holding times for preparation or analysis exceeded	J	Analyte detected below quantitation limits
	ND	Not Detected at the Reporting Limit	P	Sample pH Not In Range
	PQL	Practical Quantitative Limit	RL	Reporting Limit
	S	% Recovery outside of standard limits. If undiluted results may be estimated.		

Hall Environmental Analysis Laboratory, Inc.

Analytical Report

Lab Order 2312922

Date Reported: 1/22/2024

CLIENT: EA Engineering

Client Sample ID: DAD-22

Project: Dona Ana Dairies DADs

Collection Date: 12/14/2023 2:46:00 PM

Lab ID: 2312922-004

Matrix: GROUNDWA

Received Date: 12/15/2023 9:30:00 AM

Analyses	Result	RL	Qual	Units	DF	Date Analyzed
EPA METHOD 300.0: ANIONS						Analyst: JTT
Chloride	820	50	*	mg/L	100	12/15/2023 8:10:21 PM
Nitrogen, Nitrite (As N)	ND	1.0		mg/L	10	12/15/2023 7:57:29 PM
Nitrogen, Nitrate (As N)	15	1.0	*	mg/L	10	12/15/2023 7:57:29 PM
SM2540C MOD: TOTAL DISSOLVED SOLIDS						Analyst: KS
Total Dissolved Solids	2370	100	*D	mg/L	1	12/22/2023 11:46:00 AM
EPA 351.2: TKN						Analyst: MRA
Nitrogen, Kjeldahl, Total	ND	0.50		mg/L	1	1/13/2024 3:21:27 PM

Refer to the QC Summary report and sample login checklist for flagged QC data and preservation information.

Qualifiers:	*	Value exceeds Maximum Contaminant Level.	B	Analyte detected in the associated Method Blank
	D	Sample Diluted Due to Matrix	E	Above Quantitation Range/Estimated Value
	H	Holding times for preparation or analysis exceeded	J	Analyte detected below quantitation limits
	ND	Not Detected at the Reporting Limit	P	Sample pH Not In Range
	PQL	Practical Quantitative Limit	RL	Reporting Limit
	S	% Recovery outside of standard limits. If undiluted results may be estimated.		

Hall Environmental Analysis Laboratory, Inc.

Analytical Report

Lab Order 2312922

Date Reported: 1/22/2024

CLIENT: EA Engineering

Client Sample ID: DAD-27

Project: Dona Ana Dairies DADs

Collection Date: 12/14/2023 3:55:00 PM

Lab ID: 2312922-005

Matrix: GROUNDWA

Received Date: 12/15/2023 9:30:00 AM

Analyses	Result	RL	Qual	Units	DF	Date Analyzed
EPA METHOD 300.0: ANIONS						Analyst: JTT
Chloride	450	50	*	mg/L	100	12/15/2023 8:36:04 PM
Nitrogen, Nitrite (As N)	ND	1.0		mg/L	10	12/15/2023 8:23:12 PM
Nitrogen, Nitrate (As N)	6.4	1.0		mg/L	10	12/15/2023 8:23:12 PM
SM2540C MOD: TOTAL DISSOLVED SOLIDS						Analyst: KS
Total Dissolved Solids	2000	250	*D	mg/L	1	12/22/2023 11:46:00 AM
EPA 351.2: TKN						Analyst: MRA
Nitrogen, Kjeldahl, Total	ND	2.5	D	mg/L	1	1/13/2024 3:22:57 PM

Refer to the QC Summary report and sample login checklist for flagged QC data and preservation information.

Qualifiers:	*	Value exceeds Maximum Contaminant Level.	B	Analyte detected in the associated Method Blank
	D	Sample Diluted Due to Matrix	E	Above Quantitation Range/Estimated Value
	H	Holding times for preparation or analysis exceeded	J	Analyte detected below quantitation limits
	ND	Not Detected at the Reporting Limit	P	Sample pH Not In Range
	PQL	Practical Quantitative Limit	RL	Reporting Limit
	S	% Recovery outside of standard limits. If undiluted results may be estimated.		

QC SUMMARY REPORT

Hall Environmental Analysis Laboratory, Inc.

WO#: 2312922

22-Jan-24

Client: EA Engineering
Project: Dona Ana Dairies DADs

Sample ID: MB	SampType: MBLK	TestCode: EPA Method 300.0: Anions								
Client ID: PBW	Batch ID: R101875	RunNo: 101875								
Prep Date:	Analysis Date: 12/15/2023	SeqNo: 3756696			Units: mg/L					
Analyte	Result	PQL	SPK value	SPK Ref Val	%REC	LowLimit	HighLimit	%RPD	RPDLimit	Qual
Chloride	ND	0.50								
Nitrogen, Nitrite (As N)	ND	0.10								
Nitrogen, Nitrate (As N)	ND	0.10								

Sample ID: LCS	SampType: LCS	TestCode: EPA Method 300.0: Anions								
Client ID: LCSW	Batch ID: R101875	RunNo: 101875								
Prep Date:	Analysis Date: 12/15/2023	SeqNo: 3756697			Units: mg/L					
Analyte	Result	PQL	SPK value	SPK Ref Val	%REC	LowLimit	HighLimit	%RPD	RPDLimit	Qual
Chloride	4.9	0.50	5.000	0	97.0	90	110			
Nitrogen, Nitrite (As N)	1.0	0.10	1.000	0	99.9	90	110			
Nitrogen, Nitrate (As N)	2.5	0.10	2.500	0	102	90	110			

Sample ID: 2312922-002AMS	SampType: MS	TestCode: EPA Method 300.0: Anions								
Client ID: DAD-21	Batch ID: R101875	RunNo: 101875								
Prep Date:	Analysis Date: 12/15/2023	SeqNo: 3756725			Units: mg/L					
Analyte	Result	PQL	SPK value	SPK Ref Val	%REC	LowLimit	HighLimit	%RPD	RPDLimit	Qual
Nitrogen, Nitrite (As N)	9.5	1.0	10.00	0	94.8	80	120			
Nitrogen, Nitrate (As N)	55	1.0	25.00	28.03	107	80	120			

Sample ID: 2312922-002AMSD	SampType: MSD	TestCode: EPA Method 300.0: Anions								
Client ID: DAD-21	Batch ID: R101875	RunNo: 101875								
Prep Date:	Analysis Date: 12/15/2023	SeqNo: 3756726			Units: mg/L					
Analyte	Result	PQL	SPK value	SPK Ref Val	%REC	LowLimit	HighLimit	%RPD	RPDLimit	Qual
Nitrogen, Nitrite (As N)	9.6	1.0	10.00	0	95.9	80	120	1.12	20	
Nitrogen, Nitrate (As N)	54	1.0	25.00	28.03	106	80	120	0.721	20	

Qualifiers:

- * Value exceeds Maximum Contaminant Level.
- D Sample Diluted Due to Matrix
- H Holding times for preparation or analysis exceeded
- ND Not Detected at the Reporting Limit
- PQL Practical Quantitative Limit
- S % Recovery outside of standard limits. If undiluted results may be estimated.
- B Analyte detected in the associated Method Blank
- E Above Quantitation Range/Estimated Value
- J Analyte detected below quantitation limits
- P Sample pH Not In Range
- RL Reporting Limit

QC SUMMARY REPORT

Hall Environmental Analysis Laboratory, Inc.

WO#: 2312922

22-Jan-24

Client: EA Engineering
Project: Dona Ana Dairies DADs

Sample ID: MB-79519	SampType: MBLK	TestCode: SM2540C MOD: Total Dissolved Solids								
Client ID: PBW	Batch ID: 79519	RunNo: 102043								
Prep Date: 12/20/2023	Analysis Date: 12/22/2023	SeqNo: 3765883	Units: mg/L							
Analyte	Result	PQL	SPK value	SPK Ref Val	%REC	LowLimit	HighLimit	%RPD	RPDLimit	Qual
Total Dissolved Solids	ND	50.0								

Sample ID: LCS-79519	SampType: LCS	TestCode: SM2540C MOD: Total Dissolved Solids								
Client ID: LCSW	Batch ID: 79519	RunNo: 102043								
Prep Date: 12/20/2023	Analysis Date: 12/22/2023	SeqNo: 3765884	Units: mg/L							
Analyte	Result	PQL	SPK value	SPK Ref Val	%REC	LowLimit	HighLimit	%RPD	RPDLimit	Qual
Total Dissolved Solids	1020	50.0	1000	0	102	80	120			

Qualifiers:

- * Value exceeds Maximum Contaminant Level.
- D Sample Diluted Due to Matrix
- H Holding times for preparation or analysis exceeded
- ND Not Detected at the Reporting Limit
- PQL Practical Quantitative Limit
- S % Recovery outside of standard limits. If undiluted results may be estimated.
- B Analyte detected in the associated Method Blank
- E Above Quantitation Range/Estimated Value
- J Analyte detected below quantitation limits
- P Sample pH Not In Range
- RL Reporting Limit

QC SUMMARY REPORT

Hall Environmental Analysis Laboratory, Inc.

WO#: 2312922

22-Jan-24

Client: EA Engineering
Project: Dona Ana Dairies DADs

Sample ID: MB-79864	SampType: MBLK	TestCode: EPA 351.2: TKN								
Client ID: PBW	Batch ID: 79864	RunNo: 102531								
Prep Date: 1/11/2024	Analysis Date: 1/13/2024	SeqNo: 3787319	Units: mg/L							
Analyte	Result	PQL	SPK value	SPK Ref Val	%REC	LowLimit	HighLimit	%RPD	RPDLimit	Qual
Nitrogen, Kjeldahl, Total	ND	0.50								

Sample ID: LCS-79864	SampType: LCS	TestCode: EPA 351.2: TKN								
Client ID: LCSW	Batch ID: 79864	RunNo: 102531								
Prep Date: 1/11/2024	Analysis Date: 1/13/2024	SeqNo: 3787321	Units: mg/L							
Analyte	Result	PQL	SPK value	SPK Ref Val	%REC	LowLimit	HighLimit	%RPD	RPDLimit	Qual
Nitrogen, Kjeldahl, Total	9.5	0.50	10.00	0	95.2	90	110			

Qualifiers:

- * Value exceeds Maximum Contaminant Level.
- D Sample Diluted Due to Matrix
- H Holding times for preparation or analysis exceeded
- ND Not Detected at the Reporting Limit
- PQL Practical Quantitative Limit
- S % Recovery outside of standard limits. If undiluted results may be estimated.
- B Analyte detected in the associated Method Blank
- E Above Quantitation Range/Estimated Value
- J Analyte detected below quantitation limits
- P Sample pH Not In Range
- RL Reporting Limit

Sample Log-In Check List

Client Name: EA Engineering Work Order Number: 2312922 RcptNo: 1

Received By: Joseph Alderette 12/15/2023 9:30:00 AM *JA*
 Completed By: Cheyenne Cason 12/15/2023 10:32:20 AM *CC*
 Reviewed By: *SCM 12/15/23*

Chain of Custody

1. Is Chain of Custody complete? Yes No Not Present
 2. How was the sample delivered? FedEx

Log In

3. Was an attempt made to cool the samples? Yes No NA
 4. Were all samples received at a temperature of >0° C to 6.0°C Yes No NA
 5. Sample(s) in proper container(s)? Yes No
 6. Sufficient sample volume for indicated test(s)? Yes No
 7. Are samples (except VOA and ONG) properly preserved? Yes No
 8. Was preservative added to bottles? Yes No NA
 9. Received at least 1 vial with headspace <1/4" for AQ VOA? Yes No NA
 10. Were any sample containers received broken? Yes No
 11. Does paperwork match bottle labels?
 (Note discrepancies on chain of custody) Yes No
 12. Are matrices correctly identified on Chain of Custody? Yes No
 13. Is it clear what analyses were requested? Yes No
 14. Were all holding times able to be met?
 (If no, notify customer for authorization.) Yes No

of preserved bottles checked for pH: 5
 (2 or >12 unless noted)
 Adjusted? NO
 Checked by: JM 12/15/23

Special Handling (if applicable)

15. Was client notified of all discrepancies with this order? Yes No NA

Person Notified:	<input type="text"/>	Date:	<input type="text"/>
By Whom:	<input type="text"/>	Via:	<input type="checkbox"/> eMail <input type="checkbox"/> Phone <input type="checkbox"/> Fax <input type="checkbox"/> In Person
Regarding:	<input type="text"/>		
Client Instructions:	<input type="text"/>		

16. Additional remarks:

17. Cooler Information

Cooler No	Temp °C	Condition	Seal Intact	Seal No	Seal Date	Signed By
1	1.3	Good	Not Present	Yogi		

Chain-of-Custody Record

Client: _____

EA Engineering, Science, and Technology
Mailing Address: _____

320 Gold Ave SW Suite _____
Phone #: 505-715-4279
email or Fax#: rnullen@east.com

QA/QC Package: _____
 Standard Level 4 (Full Validation)
 Accreditation: Az Compliance
 NELAC Other _____
 EDD (Type) _____

Turn-Around Time: _____
 Standard Rush

Project Name: _____

Project #: _____
 Dona Ana Dairies (DAD'S)
 Project Manager: Gina Mullen

Sampler: Angel N. Rivera
 On Ice: Yes No
 # of Coolers: _____
 Cooler Temp (including CF): 1.2 +0.1 = 1.3°C fog



HALL ENVIRONMENTAL ANALYSIS LABORATORY
 www.hallenvironmental.com
 4901 Hawkins NE - Albuquerque, NM 87109
 Tel. 505-345-3975 Fax 505-345-4107

Analysis Request

Nitrate/Nitrites EPA Method 300	TKN SM 4500 NORG C	Chloride EPA 300	TDS SM 2540 C MOD	Sulfate EPA 300	Phosphorus EPA 6010B	Total Sulfur
X	X	X	X			
X	X	X	X			
X	X	X	X			
X	X	X	X			
X	X	X	X			

Date	Time	Matrix	Sample Name	Container Type and #	Preservative Type	HEAL No.
12-14	10:18	Gw	DAD-10	2		2312922
12-14	12:31	Gw	DAD-21	2		001
12-14	14:00	Gw	DAD-09	2		002
12-14	14:46	Gw	DAD-22	2		003
12-14	15:55	Gw	DAD-27	2		003-004
						005-005
						N ^o 1215103

Date: 12-14 Time: 17:20
 Relinquished by: *Chad*

Date: 12-15 Time: 9:30
 Received by: *Feba* Via: *Feba*

Date: _____ Time: _____
 Relinquished by: _____

Date: _____ Time: _____
 Received by: _____

Remarks: _____

If necessary, samples submitted to Hall Environmental may be subcontracted to other accredited laboratories. This serves as notice of this possibility. Any sub-contracted data will be clearly notated on the analytical report.

January 12, 2024

Regina Mullen
EA Engineering
320 Gold Ave SW Suite 1210
Albuquerque, NM 87102
TEL:
FAX:

RE: Dona Ana Dairies

OrderNo.: 2312965

Dear Regina Mullen:

Eurofins Environment Testing South Central, LLC received 3 sample(s) on 12/15/2023 for the analyses presented in the following report.

These were analyzed according to EPA procedures or equivalent. To access our accredited tests please go to www.hallenvironmental.com or the state specific web sites. In order to properly interpret your results, it is imperative that you review this report in its entirety. See the sample checklist and/or the Chain of Custody for information regarding the sample receipt temperature and preservation. Data qualifiers or a narrative will be provided if the sample analysis or analytical quality control parameters require a flag. When necessary, data qualifiers are provided on both the sample analysis report and the QC summary report, both sections should be reviewed. All samples are reported, as received, unless otherwise indicated. Lab measurement of analytes considered field parameters that require analysis within 15 minutes of sampling such as pH and residual chlorine are qualified as being analyzed outside of the recommended holding time.

Please do not hesitate to contact Eurofins Albuquerque for any additional information or clarifications.

ADHS Cert #AZ0682 -- NMED-DWB Cert #NM9425 -- NMED-Micro Cert #NM0901

Sincerely,



Andy Freeman
Laboratory Manager
4901 Hawkins NE
Albuquerque, NM 87109

Hall Environmental Analysis Laboratory, Inc.

Analytical Report

Lab Order 2312965

Date Reported: 1/12/2024

CLIENT: EA Engineering

Client Sample ID: DAD-15

Project: Dona Ana Dairies

Collection Date: 12/8/2023 10:40:00 AM

Lab ID: 2312965-001

Matrix: GROUNDWA

Received Date: 12/15/2023 2:52:00 PM

Analyses	Result	RL	Qual	Units	DF	Date Analyzed
EPA METHOD 300.0: ANIONS						Analyst: SNS
Chloride	720	50	*	mg/L	100	12/18/2023 2:08:26 PM
Nitrate+Nitrite as N	18	1.0	*	mg/L	5	12/18/2023 8:47:22 PM
SM2540C MOD: TOTAL DISSOLVED SOLIDS						Analyst: KS
Total Dissolved Solids	5060	100	*HD	mg/L	1	12/22/2023 11:46:00 AM
EPA 351.2: TKN						Analyst: DML
Nitrogen, Kjeldahl, Total	ND	0.50		mg/L	1	1/7/2024 12:20:00 PM

Refer to the QC Summary report and sample login checklist for flagged QC data and preservation information.

Qualifiers:	*	Value exceeds Maximum Contaminant Level.	B	Analyte detected in the associated Method Blank
	D	Sample Diluted Due to Matrix	E	Above Quantitation Range/Estimated Value
	H	Holding times for preparation or analysis exceeded	J	Analyte detected below quantitation limits
	ND	Not Detected at the Reporting Limit	P	Sample pH Not In Range
	PQL	Practical Quantitative Limit	RL	Reporting Limit
	S	% Recovery outside of standard limits. If undiluted results may be estimated.		

Hall Environmental Analysis Laboratory, Inc.

Analytical Report

Lab Order 2312965

Date Reported: 1/12/2024

CLIENT: EA Engineering

Client Sample ID: DAD-06R

Project: Dona Ana Dairies

Collection Date: 12/8/2023 12:55:00 PM

Lab ID: 2312965-002

Matrix: GROUNDWA

Received Date: 12/15/2023 2:52:00 PM

Analyses	Result	RL	Qual	Units	DF	Date Analyzed
EPA METHOD 300.0: ANIONS						Analyst: SNS
Chloride	98	5.0		mg/L	10	12/18/2023 2:21:19 PM
Nitrate+Nitrite as N	9.6	1.0		mg/L	5	12/18/2023 9:38:49 PM
SM2540C MOD: TOTAL DISSOLVED SOLIDS						Analyst: KS
Total Dissolved Solids	347	50.0	H	mg/L	1	12/22/2023 11:46:00 AM
EPA 351.2: TKN						Analyst: DML
Nitrogen, Kjeldahl, Total	ND	0.50		mg/L	1	1/7/2024 12:24:30 PM

Refer to the QC Summary report and sample login checklist for flagged QC data and preservation information.

Qualifiers:	*	Value exceeds Maximum Contaminant Level.	B	Analyte detected in the associated Method Blank
	D	Sample Diluted Due to Matrix	E	Above Quantitation Range/Estimated Value
	H	Holding times for preparation or analysis exceeded	J	Analyte detected below quantitation limits
	ND	Not Detected at the Reporting Limit	P	Sample pH Not In Range
	PQL	Practical Quantitative Limit	RL	Reporting Limit
	S	% Recovery outside of standard limits. If undiluted results may be estimated.		

Hall Environmental Analysis Laboratory, Inc.

Analytical Report

Lab Order 2312965

Date Reported: 1/12/2024

CLIENT: EA Engineering

Client Sample ID: DAD-24

Project: Dona Ana Dairies

Collection Date: 12/8/2023 4:18:00 PM

Lab ID: 2312965-003

Matrix: GROUNDWA

Received Date: 12/15/2023 2:52:00 PM

Analyses	Result	RL	Qual	Units	DF	Date Analyzed
EPA METHOD 300.0: ANIONS						Analyst: SNS
Chloride	1100	50	*	mg/L	100	12/18/2023 3:25:39 PM
Nitrate+Nitrite as N	6.2	1.0		mg/L	5	12/18/2023 9:51:41 PM
SM2540C MOD: TOTAL DISSOLVED SOLIDS						Analyst: KS
Total Dissolved Solids	2850	50.0	*H	mg/L	1	12/22/2023 11:46:00 AM
EPA 351.2: TKN						Analyst: DML
Nitrogen, Kjeldahl, Total	ND	0.50		mg/L	1	1/7/2024 12:26:00 PM

Refer to the QC Summary report and sample login checklist for flagged QC data and preservation information.

Qualifiers:	*	Value exceeds Maximum Contaminant Level.	B	Analyte detected in the associated Method Blank
	D	Sample Diluted Due to Matrix	E	Above Quantitation Range/Estimated Value
	H	Holding times for preparation or analysis exceeded	J	Analyte detected below quantitation limits
	ND	Not Detected at the Reporting Limit	P	Sample pH Not In Range
	PQL	Practical Quantitative Limit	RL	Reporting Limit
	S	% Recovery outside of standard limits. If undiluted results may be estimated.		

QC SUMMARY REPORT

Hall Environmental Analysis Laboratory, Inc.

WO#: 2312965

12-Jan-24

Client: EA Engineering
Project: Dona Ana Dairies

Sample ID: MB	SampType: MBLK	TestCode: EPA Method 300.0: Anions								
Client ID: PBW	Batch ID: R101930	RunNo: 101930								
Prep Date:	Analysis Date: 12/18/2023	SeqNo: 3759998			Units: mg/L					
Analyte	Result	PQL	SPK value	SPK Ref Val	%REC	LowLimit	HighLimit	%RPD	RPDLimit	Qual
Chloride	ND	0.50								
Nitrate+Nitrite as N	ND	0.20								

Sample ID: LCS	SampType: LCS	TestCode: EPA Method 300.0: Anions								
Client ID: LCSW	Batch ID: R101930	RunNo: 101930								
Prep Date:	Analysis Date: 12/18/2023	SeqNo: 3759999			Units: mg/L					
Analyte	Result	PQL	SPK value	SPK Ref Val	%REC	LowLimit	HighLimit	%RPD	RPDLimit	Qual
Chloride	4.9	0.50	5.000	0	97.2	90	110			
Nitrate+Nitrite as N	3.6	0.20	3.500	0	102	90	110			

Sample ID: 2312965-003AMS	SampType: MS	TestCode: EPA Method 300.0: Anions								
Client ID: DAD-24	Batch ID: R101930	RunNo: 101930								
Prep Date:	Analysis Date: 12/18/2023	SeqNo: 3760026			Units: mg/L					
Analyte	Result	PQL	SPK value	SPK Ref Val	%REC	LowLimit	HighLimit	%RPD	RPDLimit	Qual
Nitrate+Nitrite as N	42	2.0	35.00	6.343	102	80	120			

Sample ID: 2312965-003AMSD	SampType: MSD	TestCode: EPA Method 300.0: Anions								
Client ID: DAD-24	Batch ID: R101930	RunNo: 101930								
Prep Date:	Analysis Date: 12/18/2023	SeqNo: 3760027			Units: mg/L					
Analyte	Result	PQL	SPK value	SPK Ref Val	%REC	LowLimit	HighLimit	%RPD	RPDLimit	Qual
Nitrate+Nitrite as N	47	2.0	35.00	6.343	117	80	120	11.8	20	

Sample ID: MB	SampType: MBLK	TestCode: EPA Method 300.0: Anions								
Client ID: PBW	Batch ID: R101930	RunNo: 101930								
Prep Date:	Analysis Date: 12/18/2023	SeqNo: 3760060			Units: mg/L					
Analyte	Result	PQL	SPK value	SPK Ref Val	%REC	LowLimit	HighLimit	%RPD	RPDLimit	Qual
Chloride	ND	0.50								
Nitrate+Nitrite as N	ND	0.20								

Sample ID: LCS	SampType: LCS	TestCode: EPA Method 300.0: Anions								
Client ID: LCSW	Batch ID: R101930	RunNo: 101930								
Prep Date:	Analysis Date: 12/18/2023	SeqNo: 3760061			Units: mg/L					
Analyte	Result	PQL	SPK value	SPK Ref Val	%REC	LowLimit	HighLimit	%RPD	RPDLimit	Qual
Chloride	4.9	0.50	5.000	0	97.3	90	110			
Nitrate+Nitrite as N	3.6	0.20	3.500	0	102	90	110			

Qualifiers:

- * Value exceeds Maximum Contaminant Level.
- D Sample Diluted Due to Matrix
- H Holding times for preparation or analysis exceeded
- ND Not Detected at the Reporting Limit
- PQL Practical Quantitative Limit
- S % Recovery outside of standard limits. If undiluted results may be estimated.
- B Analyte detected in the associated Method Blank
- E Above Quantitation Range/Estimated Value
- J Analyte detected below quantitation limits
- P Sample pH Not In Range
- RL Reporting Limit

QC SUMMARY REPORT

Hall Environmental Analysis Laboratory, Inc.

WO#: 2312965

12-Jan-24

Client: EA Engineering
Project: Dona Ana Dairies

Sample ID: MB-79519	SampType: MBLK	TestCode: SM2540C MOD: Total Dissolved Solids								
Client ID: PBW	Batch ID: 79519	RunNo: 102043								
Prep Date: 12/20/2023	Analysis Date: 12/22/2023	SeqNo: 3765883	Units: mg/L							
Analyte	Result	PQL	SPK value	SPK Ref Val	%REC	LowLimit	HighLimit	%RPD	RPDLimit	Qual
Total Dissolved Solids	ND	50.0								

Sample ID: LCS-79519	SampType: LCS	TestCode: SM2540C MOD: Total Dissolved Solids								
Client ID: LCSW	Batch ID: 79519	RunNo: 102043								
Prep Date: 12/20/2023	Analysis Date: 12/22/2023	SeqNo: 3765884	Units: mg/L							
Analyte	Result	PQL	SPK value	SPK Ref Val	%REC	LowLimit	HighLimit	%RPD	RPDLimit	Qual
Total Dissolved Solids	1020	50.0	1000	0	102	80	120			

Qualifiers:

- * Value exceeds Maximum Contaminant Level.
- D Sample Diluted Due to Matrix
- H Holding times for preparation or analysis exceeded
- ND Not Detected at the Reporting Limit
- PQL Practical Quantitative Limit
- S % Recovery outside of standard limits. If undiluted results may be estimated.
- B Analyte detected in the associated Method Blank
- E Above Quantitation Range/Estimated Value
- J Analyte detected below quantitation limits
- P Sample pH Not In Range
- RL Reporting Limit

QC SUMMARY REPORT

Hall Environmental Analysis Laboratory, Inc.

WO#: 2312965

12-Jan-24

Client: EA Engineering
Project: Dona Ana Dairies

Sample ID: MB-79752	SampType: MBLK	TestCode: EPA 351.2: TKN								
Client ID: PBW	Batch ID: 79752	RunNo: 102286								
Prep Date: 1/5/2024	Analysis Date: 1/7/2024	SeqNo: 3777264	Units: mg/L							
Analyte	Result	PQL	SPK value	SPK Ref Val	%REC	LowLimit	HighLimit	%RPD	RPDLimit	Qual
Nitrogen, Kjeldahl, Total	ND	0.50								

Sample ID: LCS-79752	SampType: LCS	TestCode: EPA 351.2: TKN								
Client ID: LCSW	Batch ID: 79752	RunNo: 102286								
Prep Date: 1/5/2024	Analysis Date: 1/7/2024	SeqNo: 3777266	Units: mg/L							
Analyte	Result	PQL	SPK value	SPK Ref Val	%REC	LowLimit	HighLimit	%RPD	RPDLimit	Qual
Nitrogen, Kjeldahl, Total	9.9	0.50	10.00	0	98.6	90	110			

Qualifiers:

- * Value exceeds Maximum Contaminant Level.
- D Sample Diluted Due to Matrix
- H Holding times for preparation or analysis exceeded
- ND Not Detected at the Reporting Limit
- PQL Practical Quantitative Limit
- S % Recovery outside of standard limits. If undiluted results may be estimated.
- B Analyte detected in the associated Method Blank
- E Above Quantitation Range/Estimated Value
- J Analyte detected below quantitation limits
- P Sample pH Not In Range
- RL Reporting Limit

Sample Log-In Check List

Client Name: EA Engineering

Work Order Number: 2312965

RcptNo: 1

Received By: Joseph Alderette

12/15/2023 2:52:00 PM

JA

Completed By: Cheyenne Cason

12/15/2023 3:19:27 PM

CC

Reviewed By:

[Signature]

12/18/23

Chain of Custody

- 1. Is Chain of Custody complete? Yes No Not Present
- 2. How was the sample delivered? FedEx

Log In

- 3. Was an attempt made to cool the samples? Yes No NA
- 4. Were all samples received at a temperature of >0° C to 6.0°C Yes No NA
- 5. Sample(s) in proper container(s)? Yes No
- 6. Sufficient sample volume for indicated test(s)? Yes No
- 7. Are samples (except VOA and ONG) properly preserved? Yes No
- 8. Was preservative added to bottles? Yes No NA
- 9. Received at least 1 vial with headspace <1/4" for AQ VOA? Yes No NA
- 10. Were any sample containers received broken? Yes No
- 11. Does paperwork match bottle labels? (Note discrepancies on chain of custody) Yes No
- 12. Are matrices correctly identified on Chain of Custody? Yes No
- 13. Is it clear what analyses were requested? Yes No
- 14. Were all holding times able to be met? (If no, notify customer for authorization.) Yes No

Approved by client.

of preserved bottles checked for pH: 3
(2 or >12 unless noted)
Adjusted? NO
Checked by: JA 12/18/23

W 12/18/23

Special Handling (if applicable)

- 15. Was client notified of all discrepancies with this order? Yes No NA

Person Notified:	Gina M	Date:	12/15/2023
By Whom:	Cheyenne Cason	Via:	<input type="checkbox"/> eMail <input checked="" type="checkbox"/> Phone <input type="checkbox"/> Fax <input type="checkbox"/> In Person
Regarding:	LVM Samples out of temp. Running samples.		
Client Instructions:			

16. Additional remarks: *Samples received out of hold for TDS. W 12/18/23*

Cooler Information

Cooler No	Temp °C	Condition	Seal Intact	Seal No	Seal Date	Signed By
1	15.0	Good	Not Present	Yogi		

January 22, 2024

Regina Mullen
EA Engineering
320 Gold Ave SW Suite 1210
Albuquerque, NM 87102
TEL:
FAX:

RE: Dona Ana Dairies DADS

OrderNo.: 2312990

Dear Regina Mullen:

Eurofins Environment Testing South Central, LLC received 1 sample(s) on 12/16/2023 for the analyses presented in the following report.

These were analyzed according to EPA procedures or equivalent. To access our accredited tests please go to www.hallenvironmental.com or the state specific web sites. In order to properly interpret your results, it is imperative that you review this report in its entirety. See the sample checklist and/or the Chain of Custody for information regarding the sample receipt temperature and preservation. Data qualifiers or a narrative will be provided if the sample analysis or analytical quality control parameters require a flag. When necessary, data qualifiers are provided on both the sample analysis report and the QC summary report, both sections should be reviewed. All samples are reported, as received, unless otherwise indicated. Lab measurement of analytes considered field parameters that require analysis within 15 minutes of sampling such as pH and residual chlorine are qualified as being analyzed outside of the recommended holding time.

Please do not hesitate to contact Eurofins Albuquerque for any additional information or clarifications.

ADHS Cert #AZ0682 -- NMED-DWB Cert #NM9425 -- NMED-Micro Cert #NM0901

Sincerely,



Andy Freeman
Laboratory Manager
4901 Hawkins NE
Albuquerque, NM 87109

Hall Environmental Analysis Laboratory, Inc.

Analytical Report

Lab Order 2312990

Date Reported: 1/22/2024

CLIENT: EA Engineering

Client Sample ID: DAD-26

Project: Dona Ana Dairies DADS

Collection Date: 12/15/2023 2:57:00 PM

Lab ID: 2312990-001

Matrix: GROUNDWA

Received Date: 12/16/2023 10:15:00 AM

Analyses	Result	RL	Qual	Units	DF	Date Analyzed
EPA METHOD 300.0: ANIONS						Analyst: RBC
Chloride	1000	50	*	mg/L	100	12/20/2023 12:09:16 PM
Nitrate+Nitrite as N	14	1.0	*	mg/L	5	12/20/2023 8:13:12 PM
SM2540C MOD: TOTAL DISSOLVED SOLIDS						Analyst: KS
Total Dissolved Solids	3070	100	*D	mg/L	1	12/23/2023 4:48:00 PM
EPA 351.2: TKN						Analyst: DML
Nitrogen, Kjeldahl, Total	ND	1.2	D	mg/L	1	1/14/2024 12:04:45 PM

Refer to the QC Summary report and sample login checklist for flagged QC data and preservation information.

Qualifiers:	*	Value exceeds Maximum Contaminant Level.	B	Analyte detected in the associated Method Blank
	D	Sample Diluted Due to Matrix	E	Above Quantitation Range/Estimated Value
	H	Holding times for preparation or analysis exceeded	J	Analyte detected below quantitation limits
	ND	Not Detected at the Reporting Limit	P	Sample pH Not In Range
	PQL	Practical Quantitative Limit	RL	Reporting Limit
	S	% Recovery outside of standard limits. If undiluted results may be estimated.		

QC SUMMARY REPORT

Hall Environmental Analysis Laboratory, Inc.

WO#: 2312990

22-Jan-24

Client: EA Engineering
Project: Dona Ana Dairies DADS

Sample ID: MB	SampType: MBLK	TestCode: EPA Method 300.0: Anions								
Client ID: PBW	Batch ID: R102012	RunNo: 102012								
Prep Date:	Analysis Date: 12/20/2023	SeqNo: 3764192			Units: mg/L					
Analyte	Result	PQL	SPK value	SPK Ref Val	%REC	LowLimit	HighLimit	%RPD	RPDLimit	Qual
Chloride	ND	0.50								
Nitrate+Nitrite as N	ND	0.20								

Sample ID: LCS	SampType: LCS	TestCode: EPA Method 300.0: Anions								
Client ID: LCSW	Batch ID: R102012	RunNo: 102012								
Prep Date:	Analysis Date: 12/20/2023	SeqNo: 3764194			Units: mg/L					
Analyte	Result	PQL	SPK value	SPK Ref Val	%REC	LowLimit	HighLimit	%RPD	RPDLimit	Qual
Chloride	4.6	0.50	5.000	0	91.3	90	110			
Nitrate+Nitrite as N	3.3	0.20	3.500	0	93.6	90	110			

Sample ID: MB	SampType: MBLK	TestCode: EPA Method 300.0: Anions								
Client ID: PBW	Batch ID: R102012	RunNo: 102012								
Prep Date:	Analysis Date: 12/20/2023	SeqNo: 3764258			Units: mg/L					
Analyte	Result	PQL	SPK value	SPK Ref Val	%REC	LowLimit	HighLimit	%RPD	RPDLimit	Qual
Chloride	ND	0.50								
Nitrate+Nitrite as N	ND	0.20								

Sample ID: LCS	SampType: LCS	TestCode: EPA Method 300.0: Anions								
Client ID: LCSW	Batch ID: R102012	RunNo: 102012								
Prep Date:	Analysis Date: 12/20/2023	SeqNo: 3764259			Units: mg/L					
Analyte	Result	PQL	SPK value	SPK Ref Val	%REC	LowLimit	HighLimit	%RPD	RPDLimit	Qual
Chloride	4.6	0.50	5.000	0	92.7	90	110			
Nitrate+Nitrite as N	3.3	0.20	3.500	0	95.0	90	110			

Qualifiers:

- * Value exceeds Maximum Contaminant Level.
- D Sample Diluted Due to Matrix
- H Holding times for preparation or analysis exceeded
- ND Not Detected at the Reporting Limit
- PQL Practical Quantitative Limit
- S % Recovery outside of standard limits. If undiluted results may be estimated.
- B Analyte detected in the associated Method Blank
- E Above Quantitation Range/Estimated Value
- J Analyte detected below quantitation limits
- P Sample pH Not In Range
- RL Reporting Limit

QC SUMMARY REPORT

Hall Environmental Analysis Laboratory, Inc.

WO#: 2312990

22-Jan-24

Client: EA Engineering
Project: Dona Ana Dairies DADS

Sample ID: MB-79570	SampType: MBLK	TestCode: SM2540C MOD: Total Dissolved Solids								
Client ID: PBW	Batch ID: 79570	RunNo: 102061								
Prep Date: 12/22/2023	Analysis Date: 12/23/2023	SeqNo: 3766391	Units: mg/L							
Analyte	Result	PQL	SPK value	SPK Ref Val	%REC	LowLimit	HighLimit	%RPD	RPDLimit	Qual
Total Dissolved Solids	ND	50.0								

Sample ID: LCS-79570	SampType: LCS	TestCode: SM2540C MOD: Total Dissolved Solids								
Client ID: LCSW	Batch ID: 79570	RunNo: 102061								
Prep Date: 12/22/2023	Analysis Date: 12/23/2023	SeqNo: 3766392	Units: mg/L							
Analyte	Result	PQL	SPK value	SPK Ref Val	%REC	LowLimit	HighLimit	%RPD	RPDLimit	Qual
Total Dissolved Solids	1010	50.0	1000	0	101	80	120			

Qualifiers:

- * Value exceeds Maximum Contaminant Level.
- D Sample Diluted Due to Matrix
- H Holding times for preparation or analysis exceeded
- ND Not Detected at the Reporting Limit
- PQL Practical Quantitative Limit
- S % Recovery outside of standard limits. If undiluted results may be estimated.
- B Analyte detected in the associated Method Blank
- E Above Quantitation Range/Estimated Value
- J Analyte detected below quantitation limits
- P Sample pH Not In Range
- RL Reporting Limit

QC SUMMARY REPORT

Hall Environmental Analysis Laboratory, Inc.

WO#: 2312990

22-Jan-24

Client: EA Engineering
Project: Dona Ana Dairies DADS

Sample ID: MB-79877	SampType: MBLK	TestCode: EPA 351.2: TKN								
Client ID: PBW	Batch ID: 79877	RunNo: 102536								
Prep Date: 1/12/2024	Analysis Date: 1/14/2024	SeqNo: 3787470	Units: mg/L							
Analyte	Result	PQL	SPK value	SPK Ref Val	%REC	LowLimit	HighLimit	%RPD	RPDLimit	Qual
Nitrogen, Kjeldahl, Total	ND	0.50								

Sample ID: LCS-79877	SampType: LCS	TestCode: EPA 351.2: TKN								
Client ID: LCSW	Batch ID: 79877	RunNo: 102536								
Prep Date: 1/12/2024	Analysis Date: 1/14/2024	SeqNo: 3787472	Units: mg/L							
Analyte	Result	PQL	SPK value	SPK Ref Val	%REC	LowLimit	HighLimit	%RPD	RPDLimit	Qual
Nitrogen, Kjeldahl, Total	10	0.50	10.00	0	99.9	90	110			

Qualifiers:

- * Value exceeds Maximum Contaminant Level.
- D Sample Diluted Due to Matrix
- H Holding times for preparation or analysis exceeded
- ND Not Detected at the Reporting Limit
- PQL Practical Quantitative Limit
- S % Recovery outside of standard limits. If undiluted results may be estimated.
- B Analyte detected in the associated Method Blank
- E Above Quantitation Range/Estimated Value
- J Analyte detected below quantitation limits
- P Sample pH Not In Range
- RL Reporting Limit

Client Name: EA Engineering Work Order Number: 2312990 RcptNo: 1

Received By: Tracy Casarrubias 12/16/2023 10:15:00 AM

Completed By: Tracy Casarrubias 12/16/2023 11:15:38 AM

Reviewed By: *[Signature]* 12/18/23

Chain of Custody

1. Is Chain of Custody complete? Yes No Not Present
2. How was the sample delivered? FedEx

Log In

3. Was an attempt made to cool the samples? Yes No NA
4. Were all samples received at a temperature of >0° C to 6.0°C Yes No NA
5. Sample(s) in proper container(s)? Yes No
6. Sufficient sample volume for indicated test(s)? Yes No
7. Are samples (except VOA and ONG) properly preserved? Yes No
8. Was preservative added to bottles? Yes No NA
9. Received at least 1 vial with headspace <1/4" for AQ VOA? Yes No NA
10. Were any sample containers received broken? Yes No
11. Does paperwork match bottle labels?
 (Note discrepancies on chain of custody) Yes No
12. Are matrices correctly identified on Chain of Custody? Yes No
13. Is it clear what analyses were requested? Yes No
14. Were all holding times able to be met?
 (If no, notify customer for authorization.) Yes No

of preserved bottles checked for pH: 1
 (<2 or >12 unless noted)

Adjusted? NO

Checked by: [Signature] 12/18/23

Special Handling (if applicable)

15. Was client notified of all discrepancies with this order? Yes No NA

Person Notified: _____ Date: _____

By Whom: _____ Via: eMail Phone Fax In Person

Regarding: _____

Client Instructions: _____

16. Additional remarks:

17. Cooler Information

Cooler No	Temp °C	Condition	Seal Intact	Seal No	Seal Date	Signed By
1	3.5	Good	Not Present	Morty		

January 22, 2024

Regina Mullen
EA Engineering
320 Gold Ave SW Suite 1210
Albuquerque, NM 87102
TEL:
FAX:

RE: Sunset Dairy

OrderNo.: 2312992

Dear Regina Mullen:

Eurofins Environment Testing South Central, LLC received 1 sample(s) on 12/16/2023 for the analyses presented in the following report.

These were analyzed according to EPA procedures or equivalent. To access our accredited tests please go to www.hallenvironmental.com or the state specific web sites. In order to properly interpret your results, it is imperative that you review this report in its entirety. See the sample checklist and/or the Chain of Custody for information regarding the sample receipt temperature and preservation. Data qualifiers or a narrative will be provided if the sample analysis or analytical quality control parameters require a flag. When necessary, data qualifiers are provided on both the sample analysis report and the QC summary report, both sections should be reviewed. All samples are reported, as received, unless otherwise indicated. Lab measurement of analytes considered field parameters that require analysis within 15 minutes of sampling such as pH and residual chlorine are qualified as being analyzed outside of the recommended holding time.

Please do not hesitate to contact Eurofins Albuquerque for any additional information or clarifications.

ADHS Cert #AZ0682 -- NMED-DWB Cert #NM9425 -- NMED-Micro Cert #NM0901

Sincerely,



Andy Freeman
Laboratory Manager
4901 Hawkins NE
Albuquerque, NM 87109

Hall Environmental Analysis Laboratory, Inc.

Analytical Report

Lab Order 2312992

Date Reported: 1/22/2024

CLIENT: EA Engineering

Client Sample ID: 257-Lagoon

Project: Sunset Dairy

Collection Date: 12/15/2023 12:45:00 PM

Lab ID: 2312992-001

Matrix: AQUEOUS

Received Date: 12/16/2023 10:15:00 AM

Analyses	Result	RL	Qual	Units	DF	Date Analyzed
EPA METHOD 300.0: ANIONS						Analyst: RBC
Chloride	1300	50	*	mg/L	100	12/20/2023 12:58:54 PM
Nitrate+Nitrite as N	ND	1.0		mg/L	5	12/20/2023 9:15:14 PM
EPA METHOD 200.7: TOTAL METALS						Analyst: JRR
Sulfur	76	5.0		mg/L	5	1/3/2024 4:52:50 PM
SM2540C MOD: TOTAL DISSOLVED SOLIDS						Analyst: KS
Total Dissolved Solids	7000	5000	*D	mg/L	1	12/23/2023 4:48:00 PM
EPA 351.2: TKN						Analyst: DML
Nitrogen, Kjeldahl, Total	930	50	D	mg/L	1	1/14/2024 12:07:45 PM

Refer to the QC Summary report and sample login checklist for flagged QC data and preservation information.

Qualifiers:	*	Value exceeds Maximum Contaminant Level.	B	Analyte detected in the associated Method Blank
	D	Sample Diluted Due to Matrix	E	Above Quantitation Range/Estimated Value
	H	Holding times for preparation or analysis exceeded	J	Analyte detected below quantitation limits
	ND	Not Detected at the Reporting Limit	P	Sample pH Not In Range
	PQL	Practical Quantitative Limit	RL	Reporting Limit
	S	% Recovery outside of standard limits. If undiluted results may be estimated.		

QC SUMMARY REPORT

Hall Environmental Analysis Laboratory, Inc.

WO#: 2312992

22-Jan-24

Client: EA Engineering
Project: Sunset Dairy

Sample ID: MB-79558	SampType: MBLK	TestCode: EPA Method 200.7: Total Metals								
Client ID: PBW	Batch ID: 79558	RunNo: 102210								
Prep Date: 12/21/2023	Analysis Date: 1/2/2024	SeqNo: 3773164	Units: mg/L							
Analyte	Result	PQL	SPK value	SPK Ref Val	%REC	LowLimit	HighLimit	%RPD	RPDLimit	Qual
Sulfur	ND	1.0								

Sample ID: LCS-79558	SampType: LCS	TestCode: EPA Method 200.7: Total Metals								
Client ID: LCSW	Batch ID: 79558	RunNo: 102210								
Prep Date: 12/21/2023	Analysis Date: 1/2/2024	SeqNo: 3773171	Units: mg/L							
Analyte	Result	PQL	SPK value	SPK Ref Val	%REC	LowLimit	HighLimit	%RPD	RPDLimit	Qual
Sulfur	53	1.0	50.00	0	106	85	115			

Sample ID: MB-79558	SampType: MBLK	TestCode: EPA Method 200.7: Total Metals								
Client ID: PBW	Batch ID: 79558	RunNo: 102265								
Prep Date: 12/21/2023	Analysis Date: 1/3/2024	SeqNo: 3775386	Units: mg/L							
Analyte	Result	PQL	SPK value	SPK Ref Val	%REC	LowLimit	HighLimit	%RPD	RPDLimit	Qual
Sulfur	ND	1.0								

Sample ID: LCS-79558	SampType: LCS	TestCode: EPA Method 200.7: Total Metals								
Client ID: LCSW	Batch ID: 79558	RunNo: 102265								
Prep Date: 12/21/2023	Analysis Date: 1/3/2024	SeqNo: 3775388	Units: mg/L							
Analyte	Result	PQL	SPK value	SPK Ref Val	%REC	LowLimit	HighLimit	%RPD	RPDLimit	Qual
Sulfur	54	1.0	50.00	0	108	85	115			

Qualifiers:

- | | |
|---|---|
| * Value exceeds Maximum Contaminant Level. | B Analyte detected in the associated Method Blank |
| D Sample Diluted Due to Matrix | E Above Quantitation Range/Estimated Value |
| H Holding times for preparation or analysis exceeded | J Analyte detected below quantitation limits |
| ND Not Detected at the Reporting Limit | P Sample pH Not In Range |
| PQL Practical Quantitative Limit | RL Reporting Limit |
| S % Recovery outside of standard limits. If undiluted results may be estimated. | |

QC SUMMARY REPORT

Hall Environmental Analysis Laboratory, Inc.

WO#: 2312992

22-Jan-24

Client: EA Engineering
Project: Sunset Dairy

Sample ID: MB	SampType: MBLK	TestCode: EPA Method 300.0: Anions								
Client ID: PBW	Batch ID: R102012	RunNo: 102012								
Prep Date:	Analysis Date: 12/20/2023	SeqNo: 3764192			Units: mg/L					
Analyte	Result	PQL	SPK value	SPK Ref Val	%REC	LowLimit	HighLimit	%RPD	RPDLimit	Qual
Chloride	ND	0.50								
Nitrate+Nitrite as N	ND	0.20								

Sample ID: LCS	SampType: LCS	TestCode: EPA Method 300.0: Anions								
Client ID: LCSW	Batch ID: R102012	RunNo: 102012								
Prep Date:	Analysis Date: 12/20/2023	SeqNo: 3764194			Units: mg/L					
Analyte	Result	PQL	SPK value	SPK Ref Val	%REC	LowLimit	HighLimit	%RPD	RPDLimit	Qual
Chloride	4.6	0.50	5.000	0	91.3	90	110			
Nitrate+Nitrite as N	3.3	0.20	3.500	0	93.6	90	110			

Sample ID: MB	SampType: MBLK	TestCode: EPA Method 300.0: Anions								
Client ID: PBW	Batch ID: R102012	RunNo: 102012								
Prep Date:	Analysis Date: 12/20/2023	SeqNo: 3764258			Units: mg/L					
Analyte	Result	PQL	SPK value	SPK Ref Val	%REC	LowLimit	HighLimit	%RPD	RPDLimit	Qual
Chloride	ND	0.50								
Nitrate+Nitrite as N	ND	0.20								

Sample ID: LCS	SampType: LCS	TestCode: EPA Method 300.0: Anions								
Client ID: LCSW	Batch ID: R102012	RunNo: 102012								
Prep Date:	Analysis Date: 12/20/2023	SeqNo: 3764259			Units: mg/L					
Analyte	Result	PQL	SPK value	SPK Ref Val	%REC	LowLimit	HighLimit	%RPD	RPDLimit	Qual
Chloride	4.6	0.50	5.000	0	92.7	90	110			
Nitrate+Nitrite as N	3.3	0.20	3.500	0	95.0	90	110			

Qualifiers:

- | | |
|---|---|
| * Value exceeds Maximum Contaminant Level. | B Analyte detected in the associated Method Blank |
| D Sample Diluted Due to Matrix | E Above Quantitation Range/Estimated Value |
| H Holding times for preparation or analysis exceeded | J Analyte detected below quantitation limits |
| ND Not Detected at the Reporting Limit | P Sample pH Not In Range |
| PQL Practical Quantitative Limit | RL Reporting Limit |
| S % Recovery outside of standard limits. If undiluted results may be estimated. | |

QC SUMMARY REPORT

Hall Environmental Analysis Laboratory, Inc.

WO#: 2312992

22-Jan-24

Client: EA Engineering
Project: Sunset Dairy

Sample ID: MB-79570	SampType: MBLK	TestCode: SM2540C MOD: Total Dissolved Solids								
Client ID: PBW	Batch ID: 79570	RunNo: 102061								
Prep Date: 12/22/2023	Analysis Date: 12/23/2023	SeqNo: 3766391	Units: mg/L							
Analyte	Result	PQL	SPK value	SPK Ref Val	%REC	LowLimit	HighLimit	%RPD	RPDLimit	Qual
Total Dissolved Solids	ND	50.0								

Sample ID: LCS-79570	SampType: LCS	TestCode: SM2540C MOD: Total Dissolved Solids								
Client ID: LCSW	Batch ID: 79570	RunNo: 102061								
Prep Date: 12/22/2023	Analysis Date: 12/23/2023	SeqNo: 3766392	Units: mg/L							
Analyte	Result	PQL	SPK value	SPK Ref Val	%REC	LowLimit	HighLimit	%RPD	RPDLimit	Qual
Total Dissolved Solids	1010	50.0	1000	0	101	80	120			

Qualifiers:

- * Value exceeds Maximum Contaminant Level.
- D Sample Diluted Due to Matrix
- H Holding times for preparation or analysis exceeded
- ND Not Detected at the Reporting Limit
- PQL Practical Quantitative Limit
- S % Recovery outside of standard limits. If undiluted results may be estimated.
- B Analyte detected in the associated Method Blank
- E Above Quantitation Range/Estimated Value
- J Analyte detected below quantitation limits
- P Sample pH Not In Range
- RL Reporting Limit

QC SUMMARY REPORT

Hall Environmental Analysis Laboratory, Inc.

WO#: 2312992

22-Jan-24

Client: EA Engineering
Project: Sunset Dairy

Sample ID: MB-79877	SampType: MBLK	TestCode: EPA 351.2: TKN								
Client ID: PBW	Batch ID: 79877	RunNo: 102536								
Prep Date: 1/12/2024	Analysis Date: 1/14/2024	SeqNo: 3787470	Units: mg/L							
Analyte	Result	PQL	SPK value	SPK Ref Val	%REC	LowLimit	HighLimit	%RPD	RPDLimit	Qual
Nitrogen, Kjeldahl, Total	ND	0.50								

Sample ID: LCS-79877	SampType: LCS	TestCode: EPA 351.2: TKN								
Client ID: LCSW	Batch ID: 79877	RunNo: 102536								
Prep Date: 1/12/2024	Analysis Date: 1/14/2024	SeqNo: 3787472	Units: mg/L							
Analyte	Result	PQL	SPK value	SPK Ref Val	%REC	LowLimit	HighLimit	%RPD	RPDLimit	Qual
Nitrogen, Kjeldahl, Total	10	0.50	10.00	0	99.9	90	110			

Qualifiers:

- * Value exceeds Maximum Contaminant Level.
- D Sample Diluted Due to Matrix
- H Holding times for preparation or analysis exceeded
- ND Not Detected at the Reporting Limit
- PQL Practical Quantitative Limit
- S % Recovery outside of standard limits. If undiluted results may be estimated.
- B Analyte detected in the associated Method Blank
- E Above Quantitation Range/Estimated Value
- J Analyte detected below quantitation limits
- P Sample pH Not In Range
- RL Reporting Limit

Client Name: EA Engineering

Work Order Number: 2312992

RcptNo: 1

Received By: Tracy Casarrubias

12/16/2023 10:15:00 AM

Completed By: Tracy Casarrubias

12/16/2023 11:25:56 AM

Reviewed By:

12/18/23

Chain of Custody

1. Is Chain of Custody complete? Yes No Not Present

2. How was the sample delivered? FedEx

Log In

3. Was an attempt made to cool the samples? Yes No NA

4. Were all samples received at a temperature of >0° C to 6.0°C Yes No NA

5. Sample(s) in proper container(s)? Yes No

6. Sufficient sample volume for indicated test(s)? Yes No

7. Are samples (except VOA and ONG) properly preserved? Yes No

8. Was preservative added to bottles? Yes No NA

9. Received at least 1 vial with headspace <1/4" for AQ VOA? Yes No HNO3 NA

10. Were any sample containers received broken? Yes No

11. Does paperwork match bottle labels? (Note discrepancies on chain of custody) Yes No

12. Are matrices correctly identified on Chain of Custody? Yes No

13. Is it clear what analyses were requested? Yes No

14. Were all holding times able to be met? (If no, notify customer for authorization.) Yes No

of preserved bottles checked for pH: 2
 (<2 or >12 unless noted)
 Adjusted? yes
 Checked by: Ju 12/18/23

Special Handling (if applicable)

15. Was client notified of all discrepancies with this order? Yes No NA

Person Notified:	<input type="text"/>	Date:	<input type="text"/>
By Whom:	<input type="text"/>	Via:	<input type="checkbox"/> eMail <input type="checkbox"/> Phone <input type="checkbox"/> Fax <input type="checkbox"/> In Person
Regarding:	<input type="text"/>		
Client Instructions:	<input type="text"/>		

16. Additional remarks:

From original unpreserved volume provided, ~200mL was poured off into 250mL HDPE bottle for metal analysis and ~50mL of HNO3 (Chem#7342) was added for proper pH. ~2.0mL of H2SO4 (7343) was added to

17. Cooler Information

sample 0013 for pH < 2. Ju 12/18/23

Cooler No	Temp °C	Condition	Seal Intact	Seal No	Seal Date	Signed By
1	3.5	Good	Not Present	Morty		

APPENDIX D
HYDROGRAPHS BY AREA

HYDROGRAPHS FOR SELECT DP MONITORING WELLS NORTHERN PORTION DONA ANA DAIRIES, DONA ANA COUNTY, NEW MEXICO

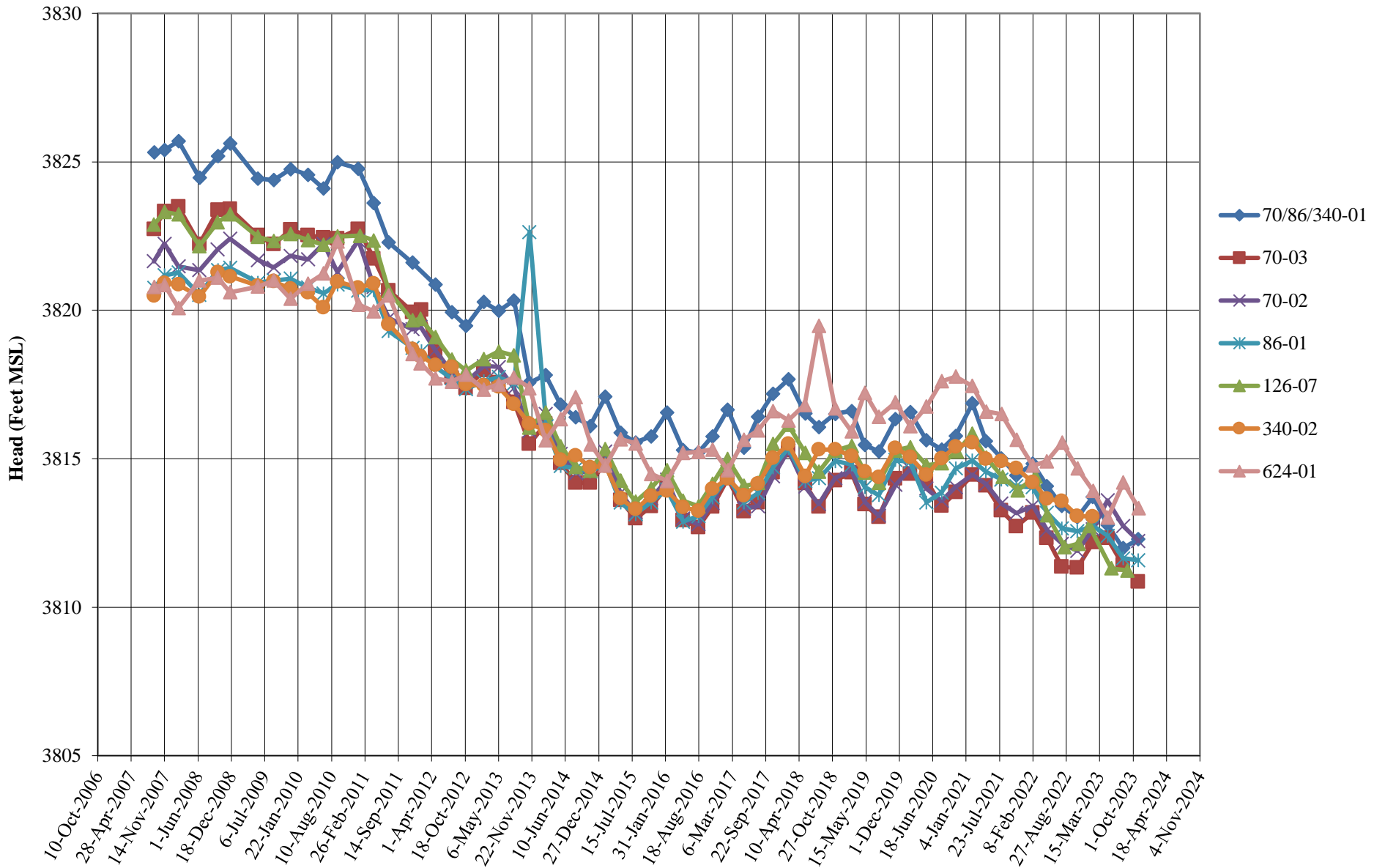

HYDROGRAPHS FOR DP MONITORING WELLS SOUTHERN PORTION DONA ANA DAIRIES, DONA ANA COUNTY, NEW MEXICO

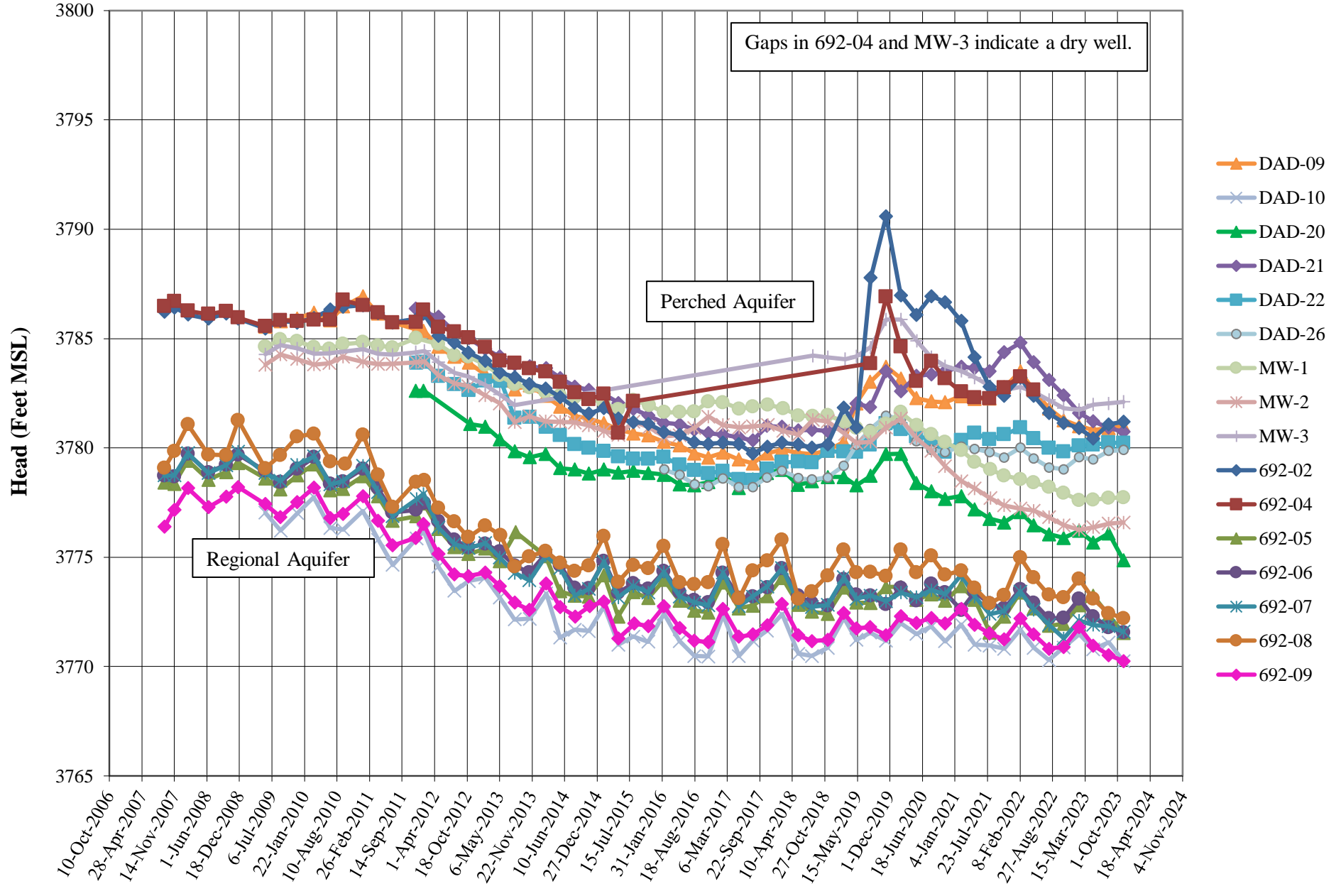

APPENDIX E
FIELD PARAMETER TRENDS BY AREA

SPECIFIC CONDUCTANCE TRENDS
NORTHERN AREA DISCHARGE PLAN MONITORING WELLS
DONA ANA DAIRIES, DONA ANA COUNTY, NEW MEXICO

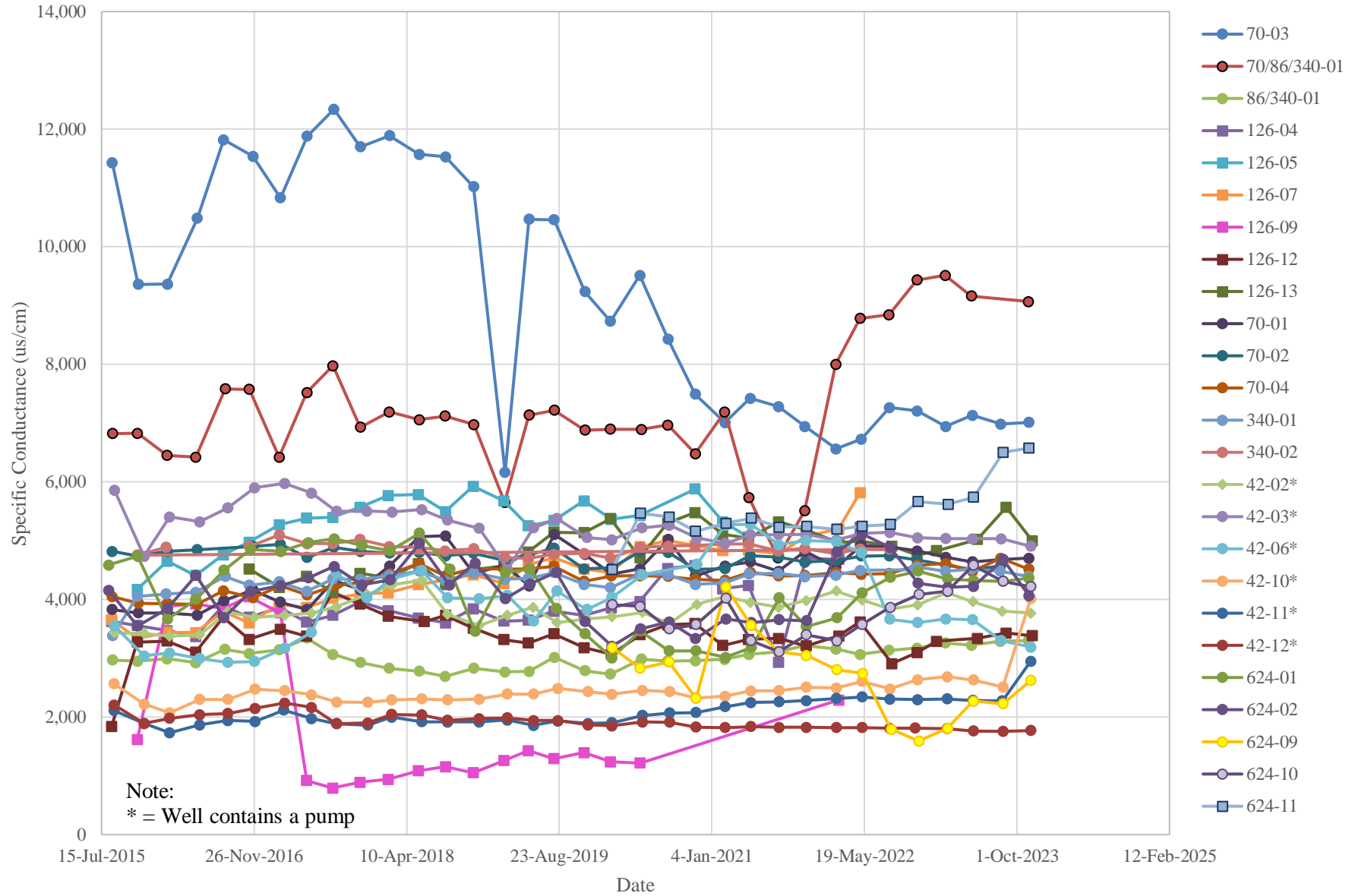

**DISSOLVED OXYGEN TRENDS
NORTHERN AREA DISCHARGE PLAN MONITORING WELLS
DONA ANA DAIRIES, DONA ANA COUNTY, NEW MEXICO**

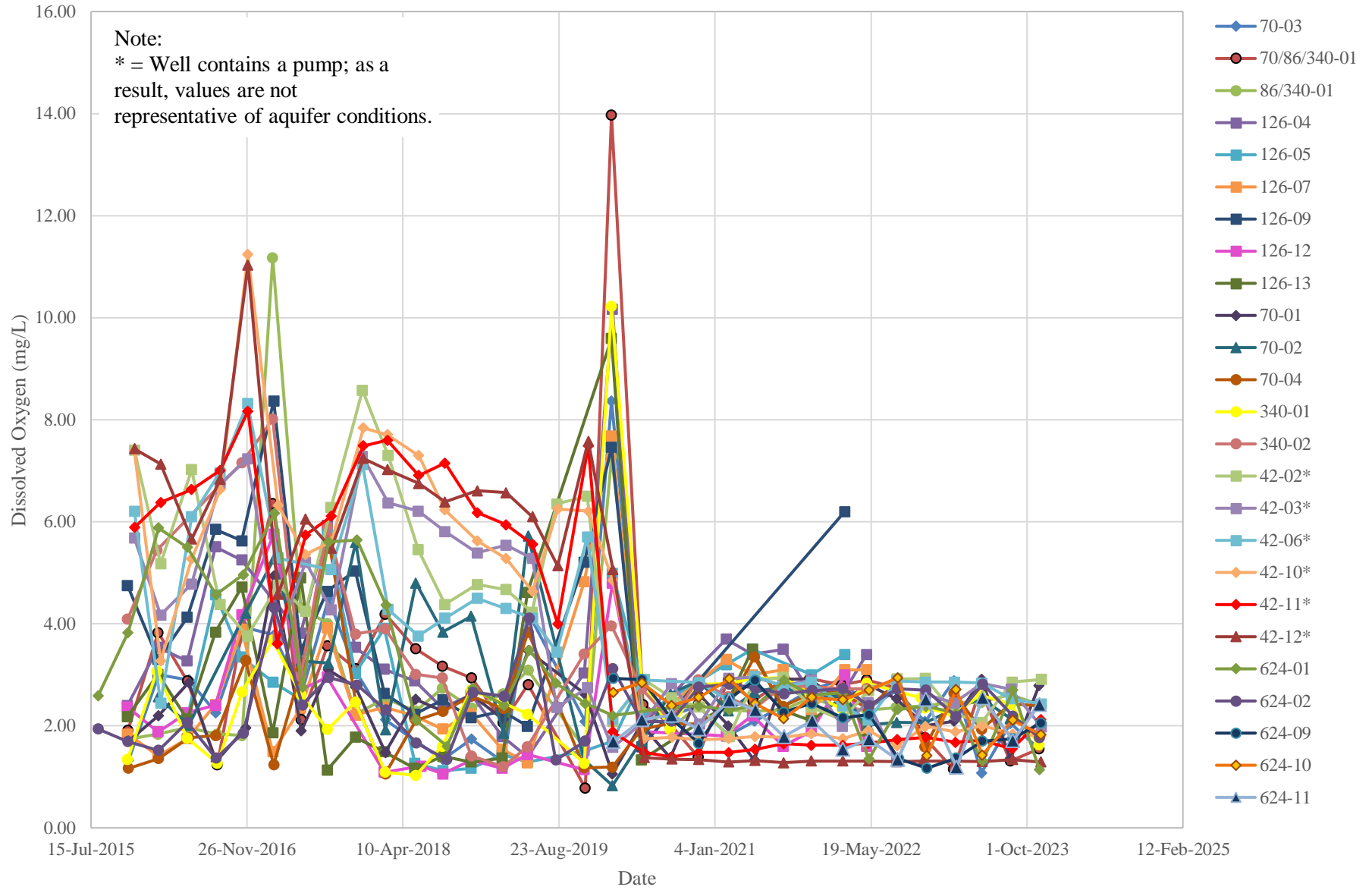

**OXIDATION-REDUCTION POTENTIAL TRENDS
NORTHERN AREA DISCHARGE PLAN MONITORING WELLS
DONA ANA DAIRIES, DONA ANA COUNTY, NEW MEXICO**

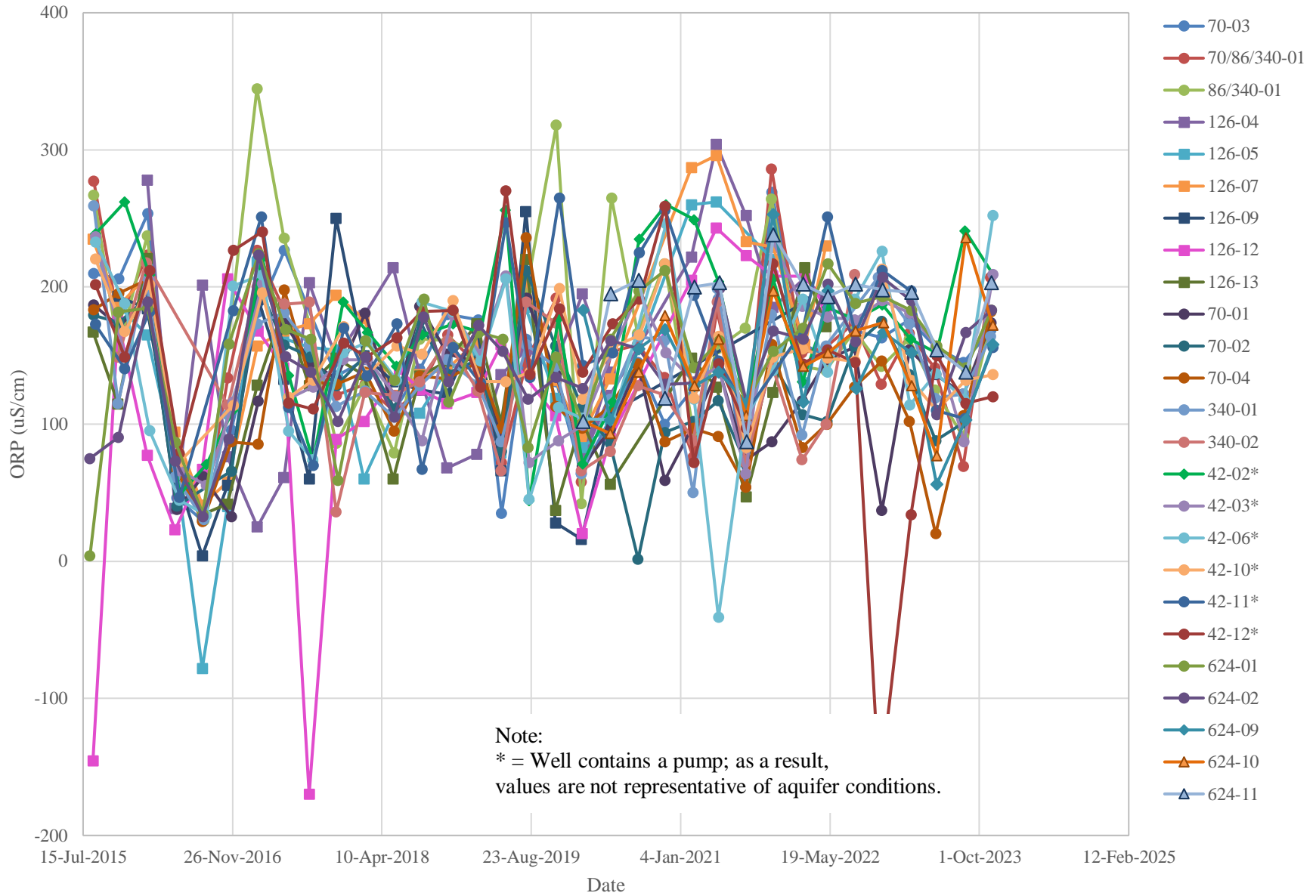

**SPECIFIC CONDUCTANCE TRENDS
CENTRAL AREA DISCHARGE PLAN MONITORING WELLS
DONA ANA DAIRIES, DONA ANA COUNTY, NEW MEXICO**

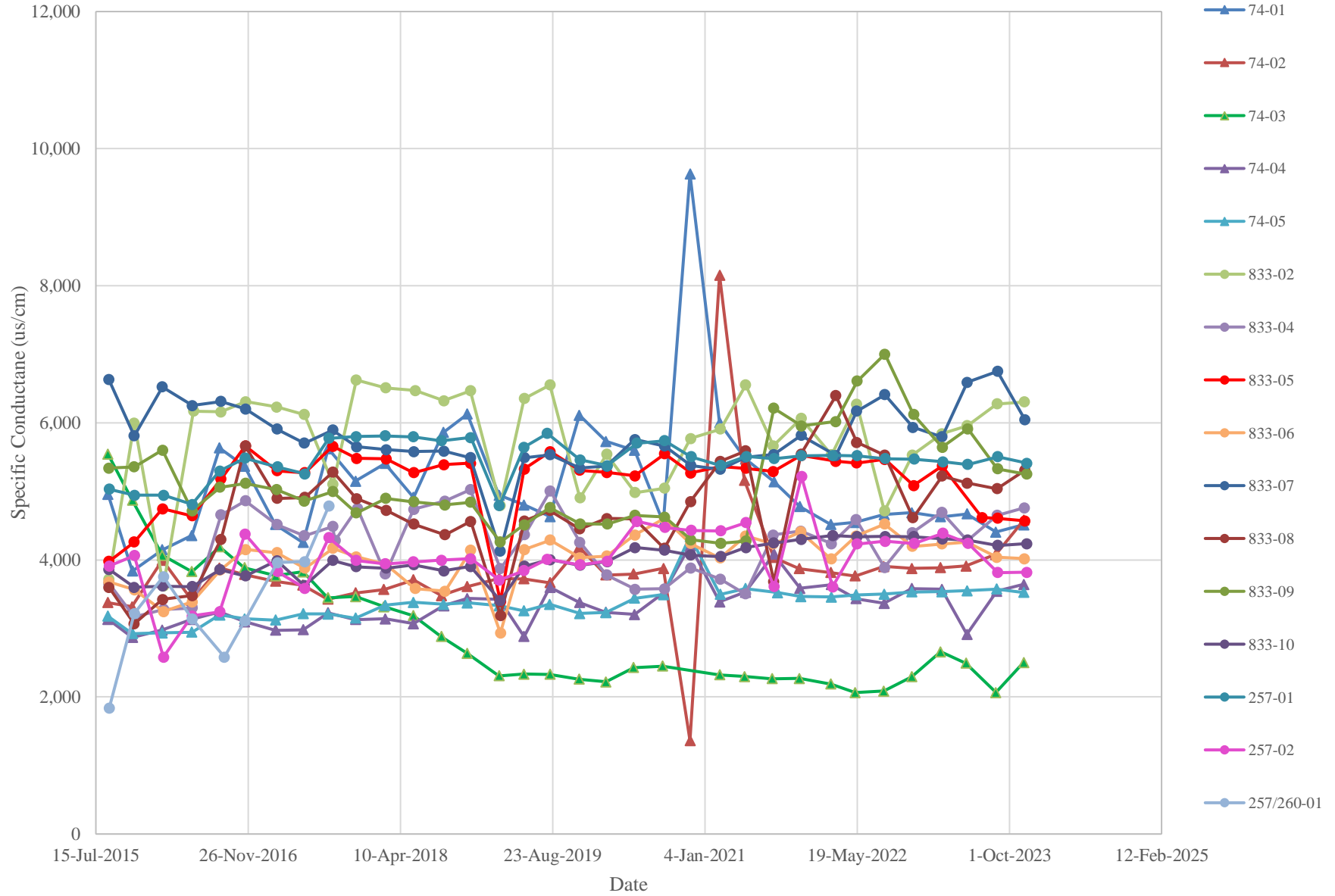

DISSOLVED OXYGEN TRENDS
CENTRAL AREA DISCHARGE PLAN MONITORING WELLS
DONA ANA DAIRIES, DONA ANA COUNTY, NEW MEXICO

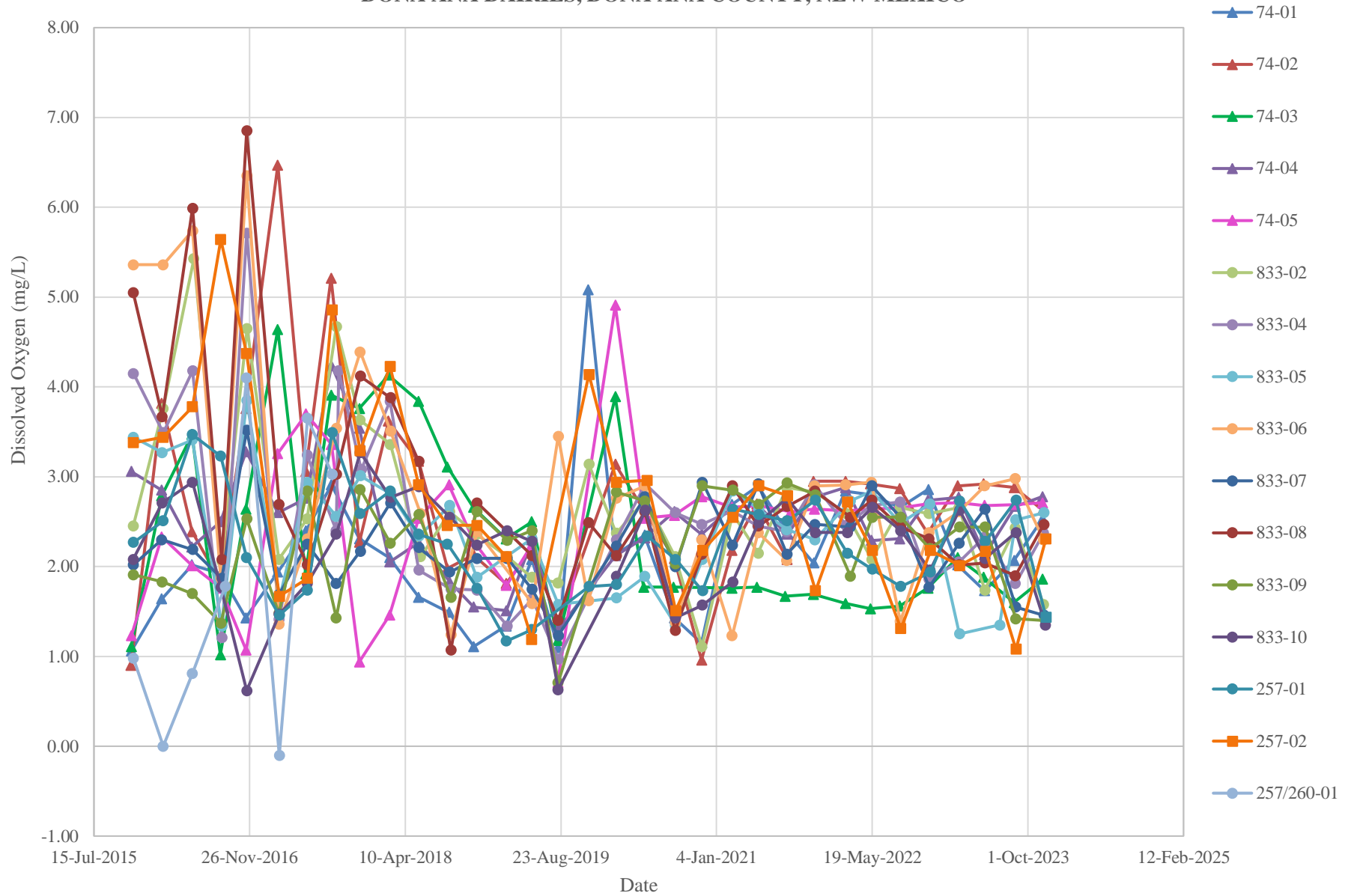

**OXIDATION-REDUCTION POTENTIAL TRENDS
CENTRAL AREA DISCHARGE PLAN MONITORING WELLS
DONA ANA DAIRIES, DONA ANA COUNTY, NEW MEXICO**

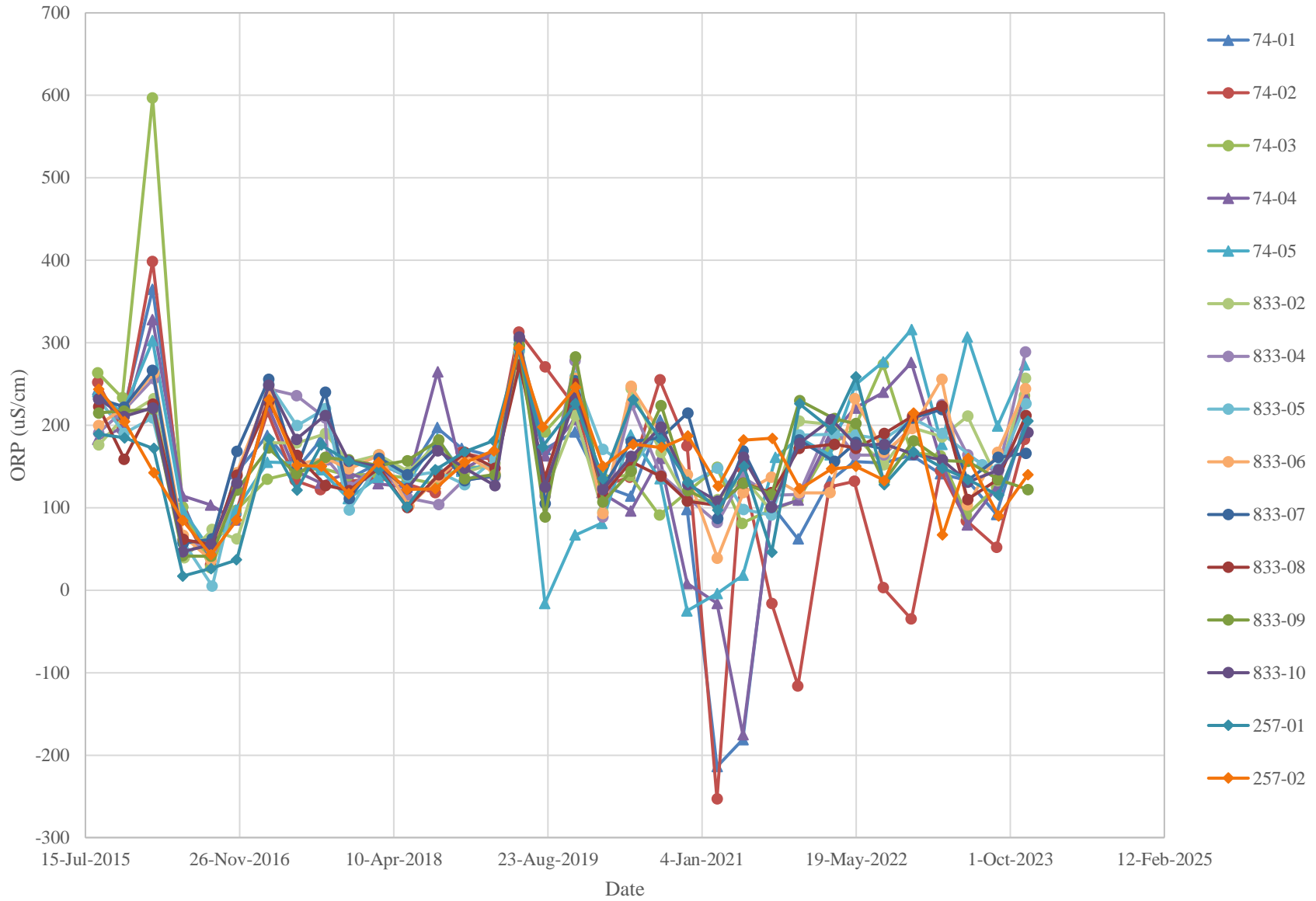

**SPECIFIC CONDUCTANCE TRENDS
SOUTHERN AREA DISCHARGE PLAN MONITORING WELLS
IN THE REGIONAL AQUIFER
DONA ANA DAIRIES, DONA ANA COUNTY, NEW MEXICO**

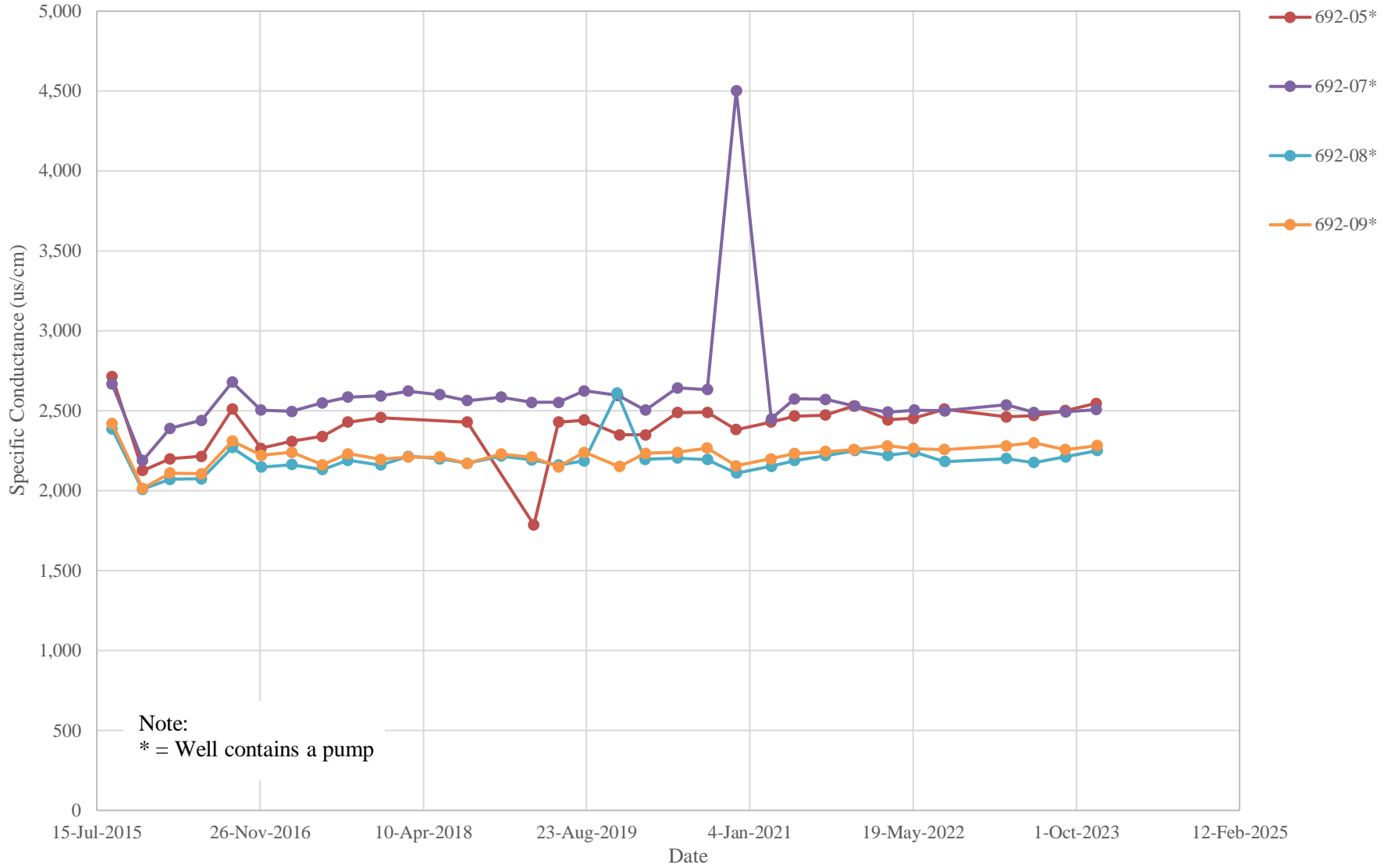

**DISSOLVED OXYGEN TRENDS
SOUTHERN AREA DISCHARGE PLAN MONITORING WELLS
IN THE REGIONAL AQUIFER
DONA ANA DAIRIES, DONA ANA COUNTY, NEW MEXICO**

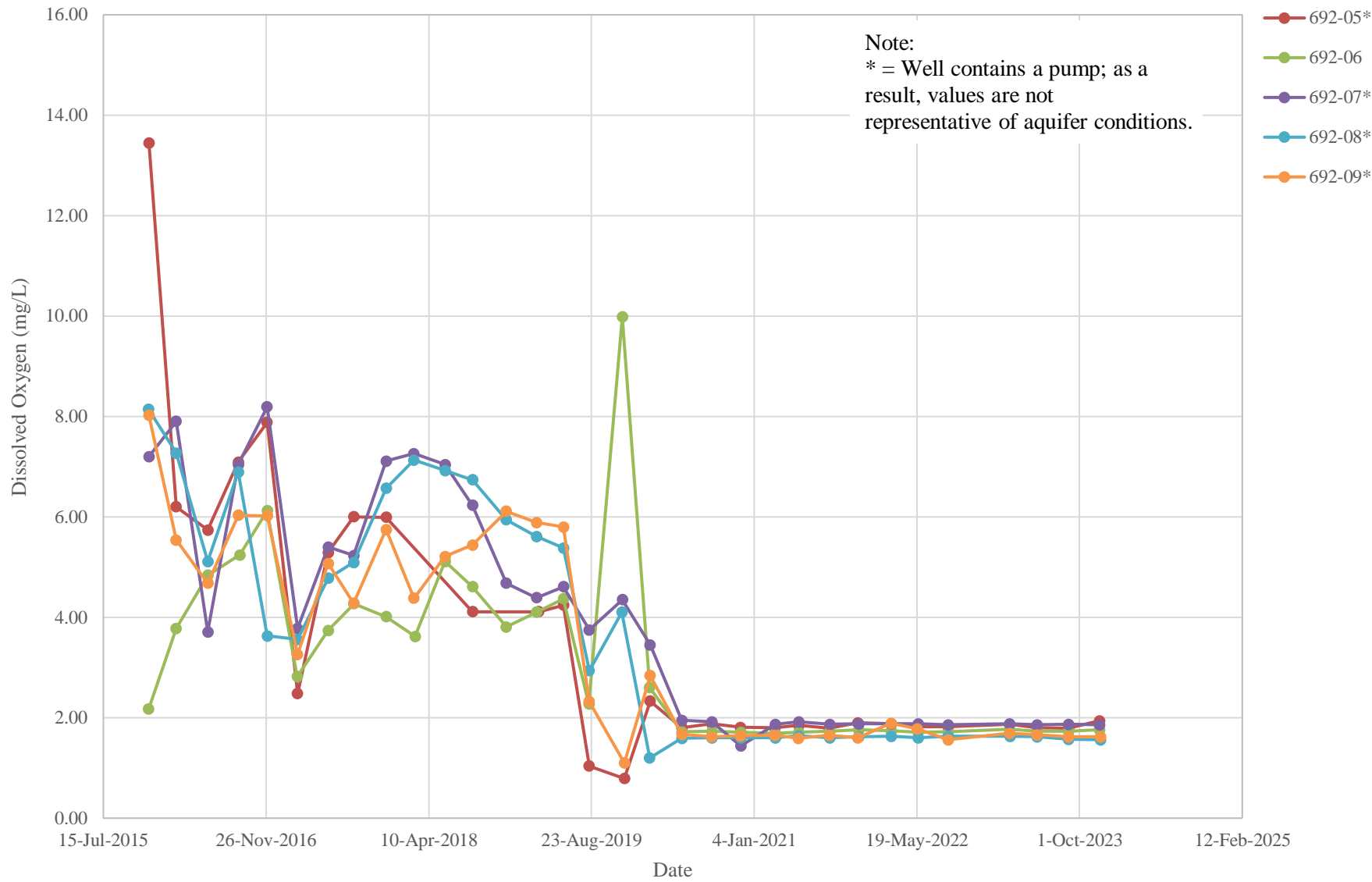

**OXIDATION-REDUCTION POTENTIAL TRENDS
SOUTHERN AREA DISCHARGE PLAN MONITORING WELLS
DONA ANA DAIRIES, DONA ANA COUNTY, NEW MEXICO**

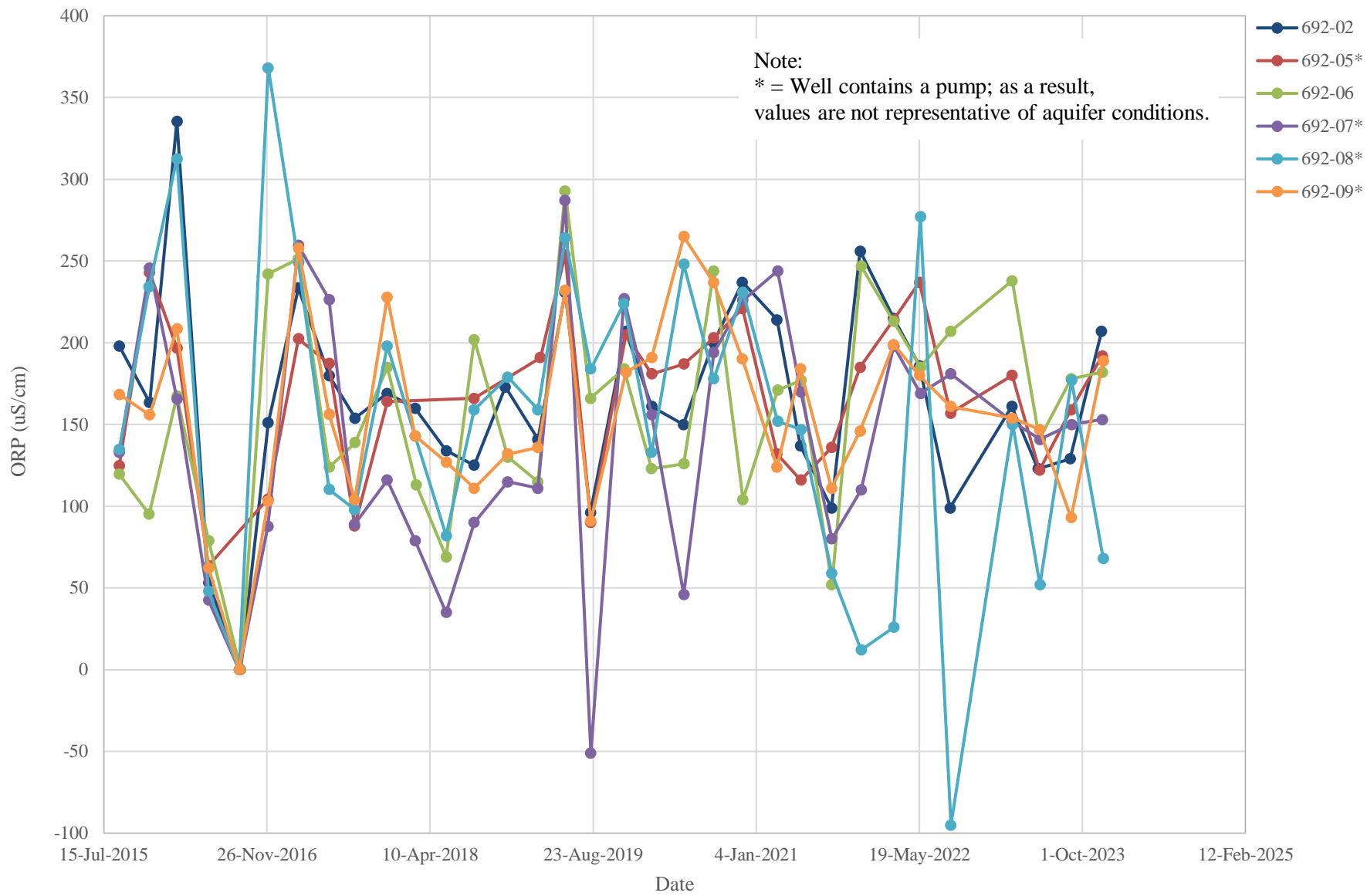

**SPECIFIC CONDUCTANCE TRENDS
SOUTHERN AREA DISCHARGE PLAN MONITORING WELLS
IN THE PERCHED AQUIFER
DONA ANA DAIRIES, DONA ANA COUNTY, NEW MEXICO**

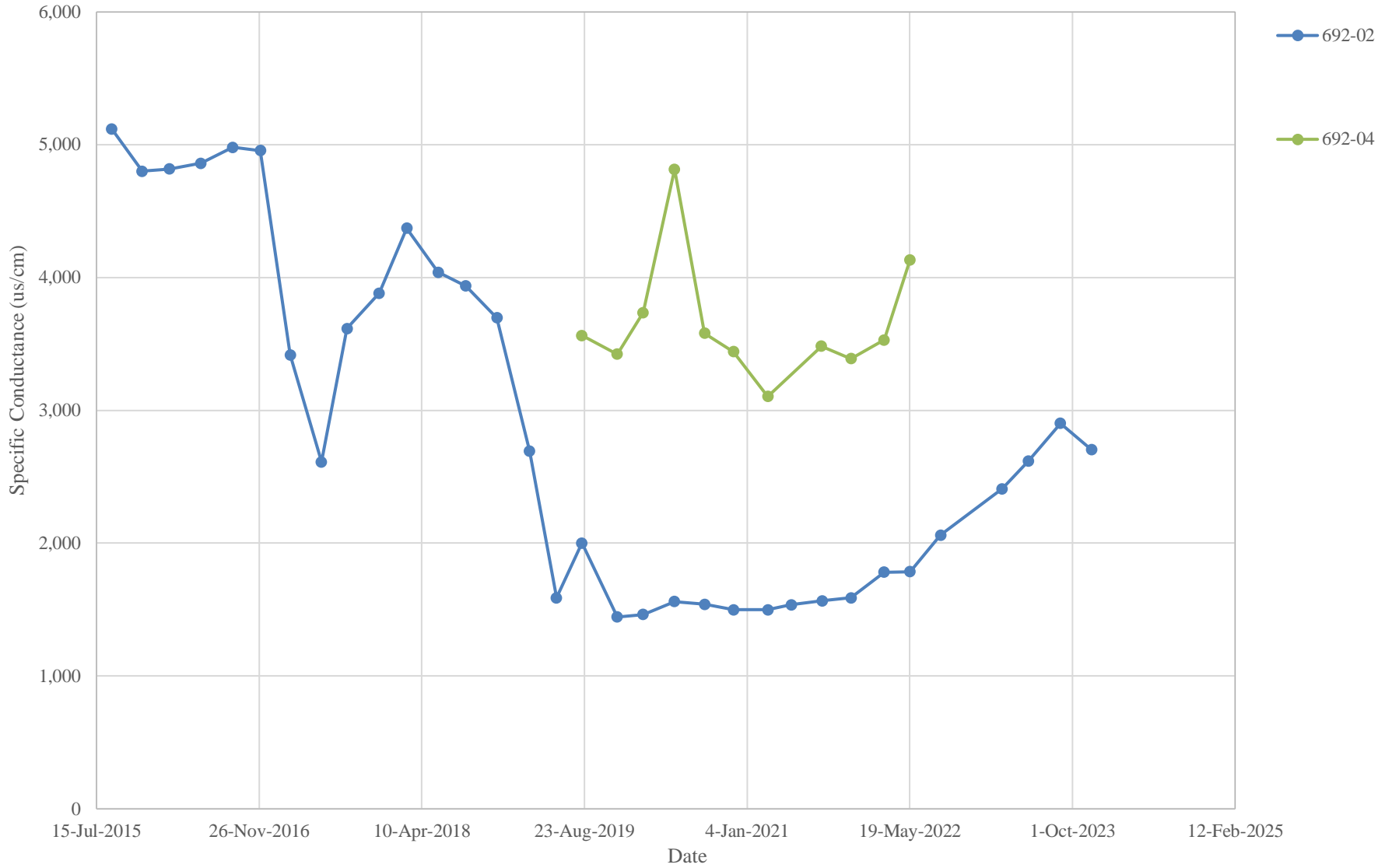

**DISSOLVED OXYGEN TRENDS
SOUTHERN AREA DISCHARGE PLAN MONITORING WELLS
DONA ANA DAIRIES, DONA ANA COUNTY, NEW MEXICO**

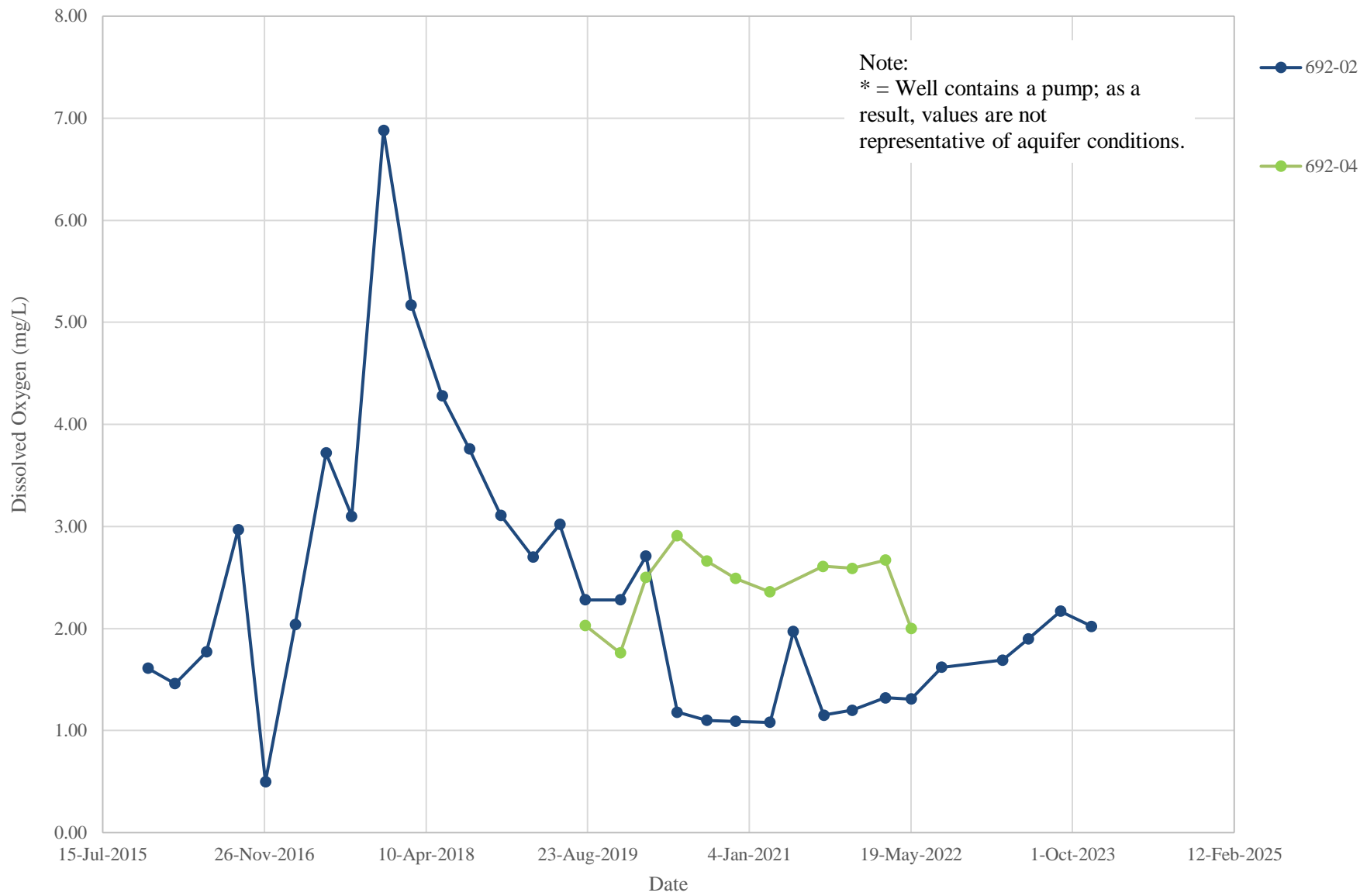

**OXIDATION-REDUCTION POTENTIAL TRENDS
SOUTHERN AREA DISCHARGE PLAN MONITORING WELLS
IN THE PERCHED AQUIFER
DONA ANA DAIRIES, DONA ANA COUNTY, NEW MEXICO**

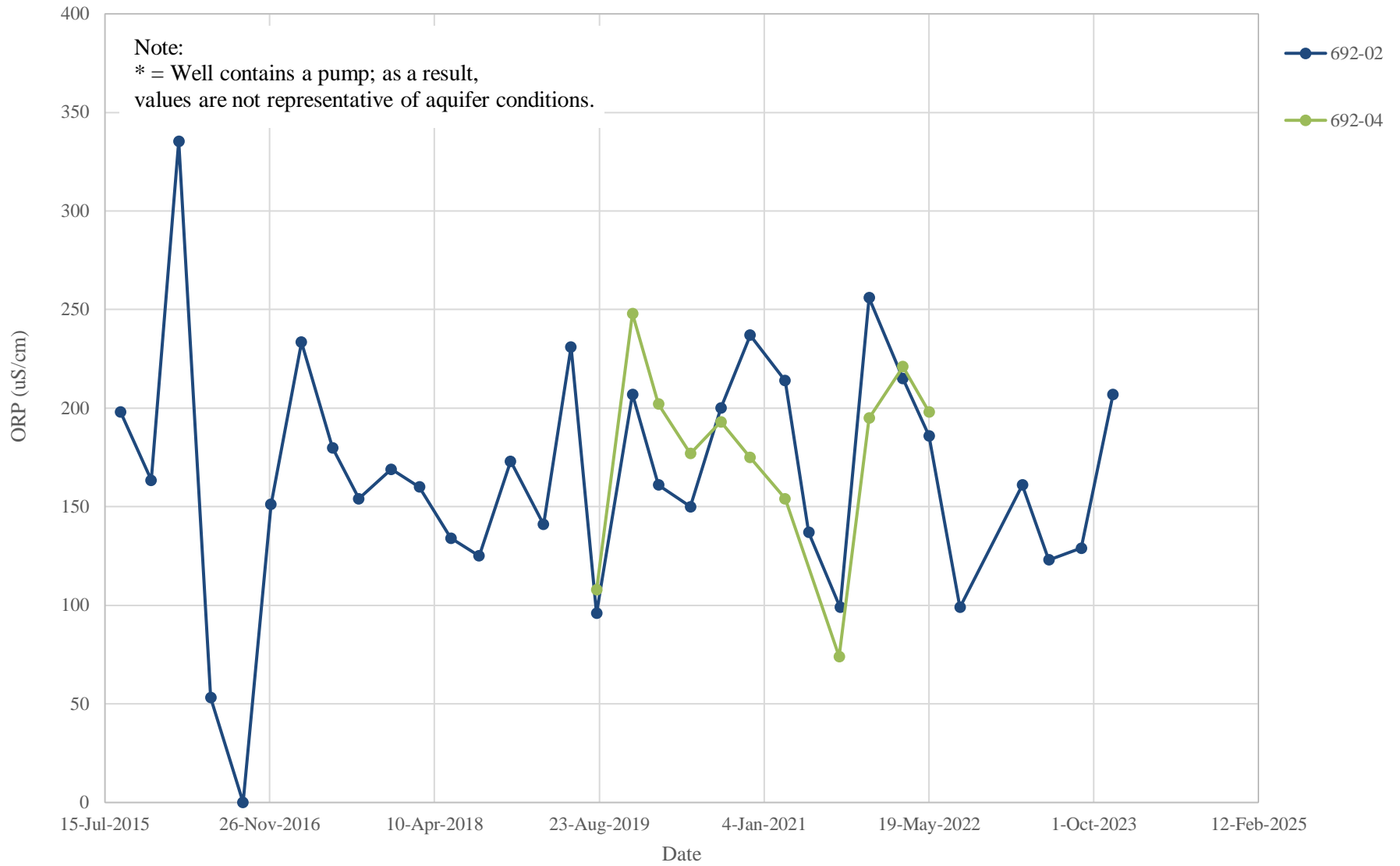

APPENDIX F

**CONCENTRATION TRENDS BY AREA -
ABATEMENT PLAN WELLS**

**NITRATE CONCENTRATION TRENDS
NORTHERN ABATEMENT PLAN MONITORING WELLS
DONA ANA DAIRIES, DONA ANA COUNTY, NEW MEXICO**

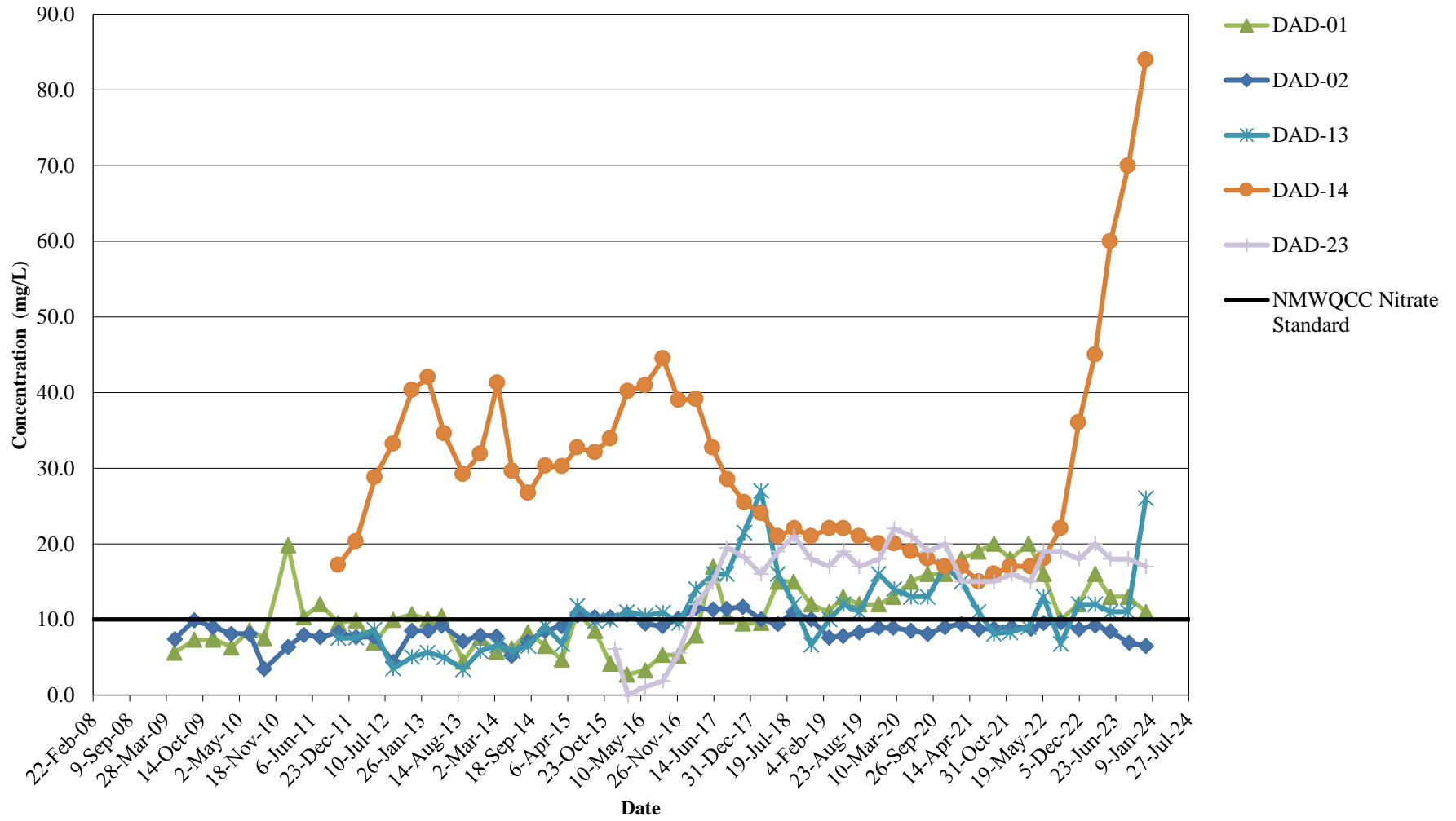

**NITRATE CONCENTRATION TRENDS
 NORTHERN ABATEMENT PLAN MONITORING WELLS -
 VERTICAL DELINEATION
 DONA ANA DAIRIES, DONA ANA COUNTY, NEW MEXICO**

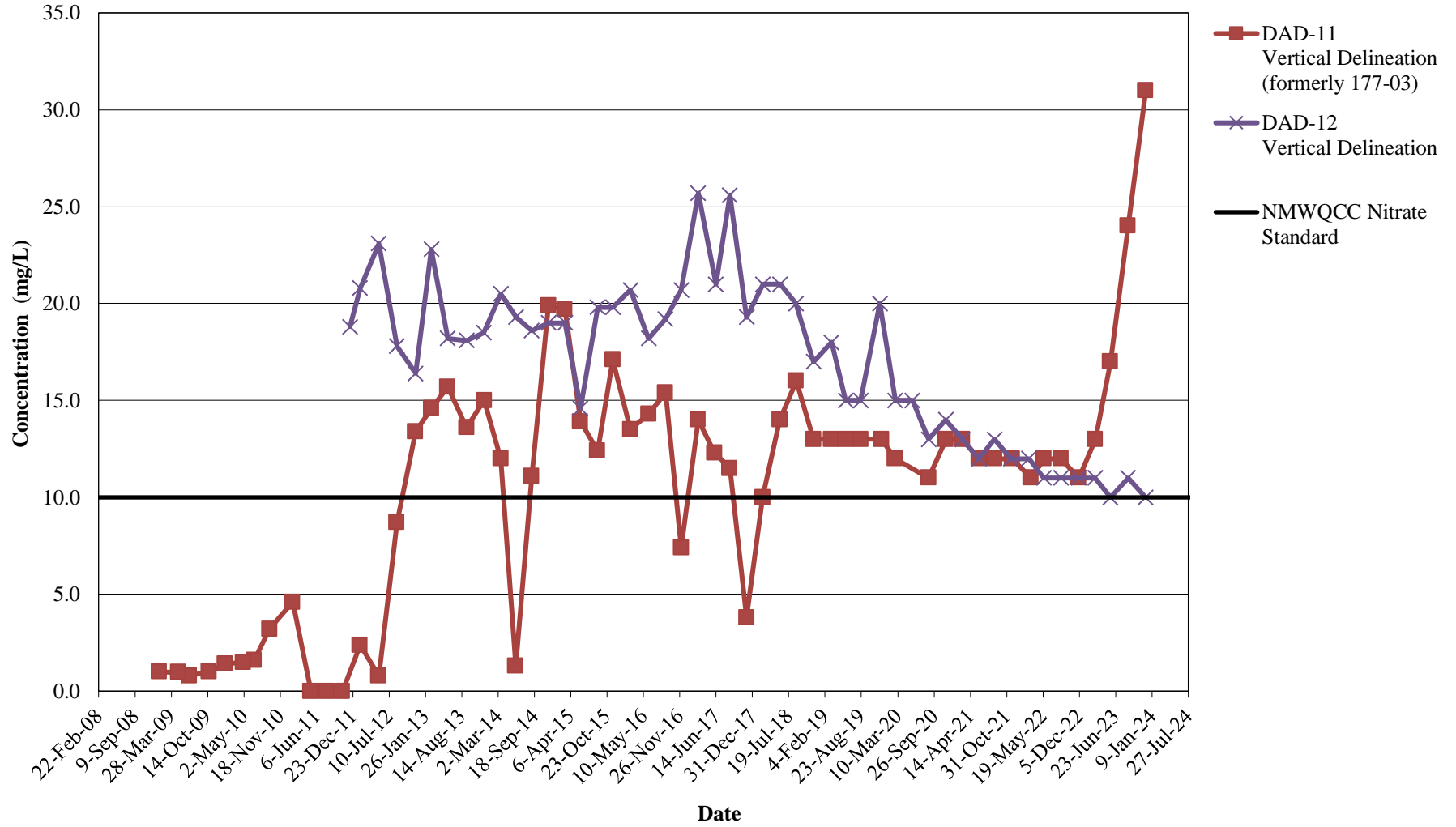

**NITRATE CONCENTRATION TRENDS
CENTRAL ABATEMENT PLAN MONITORING WELLS
DONA ANA DAIRIES, DONA ANA COUNTY, NEW MEXICO**

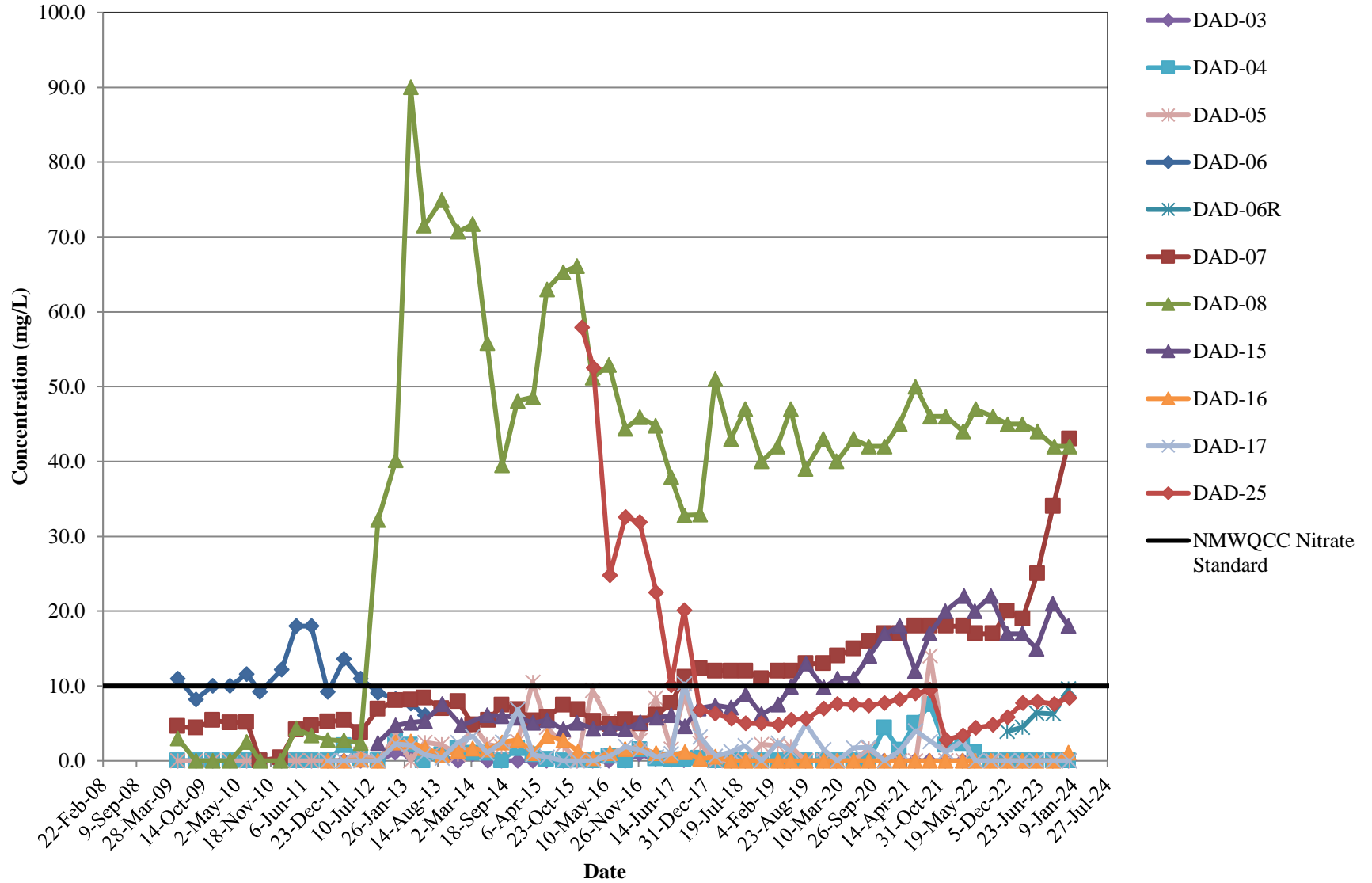

**NITRATE CONCENTRATION TRENDS
CENTRAL ABATEMENT PLAN MONITORING WELLS -
VERTICAL DELINEATION
DONA ANA DAIRIES, DONA ANA COUNTY, NEW MEXICO**

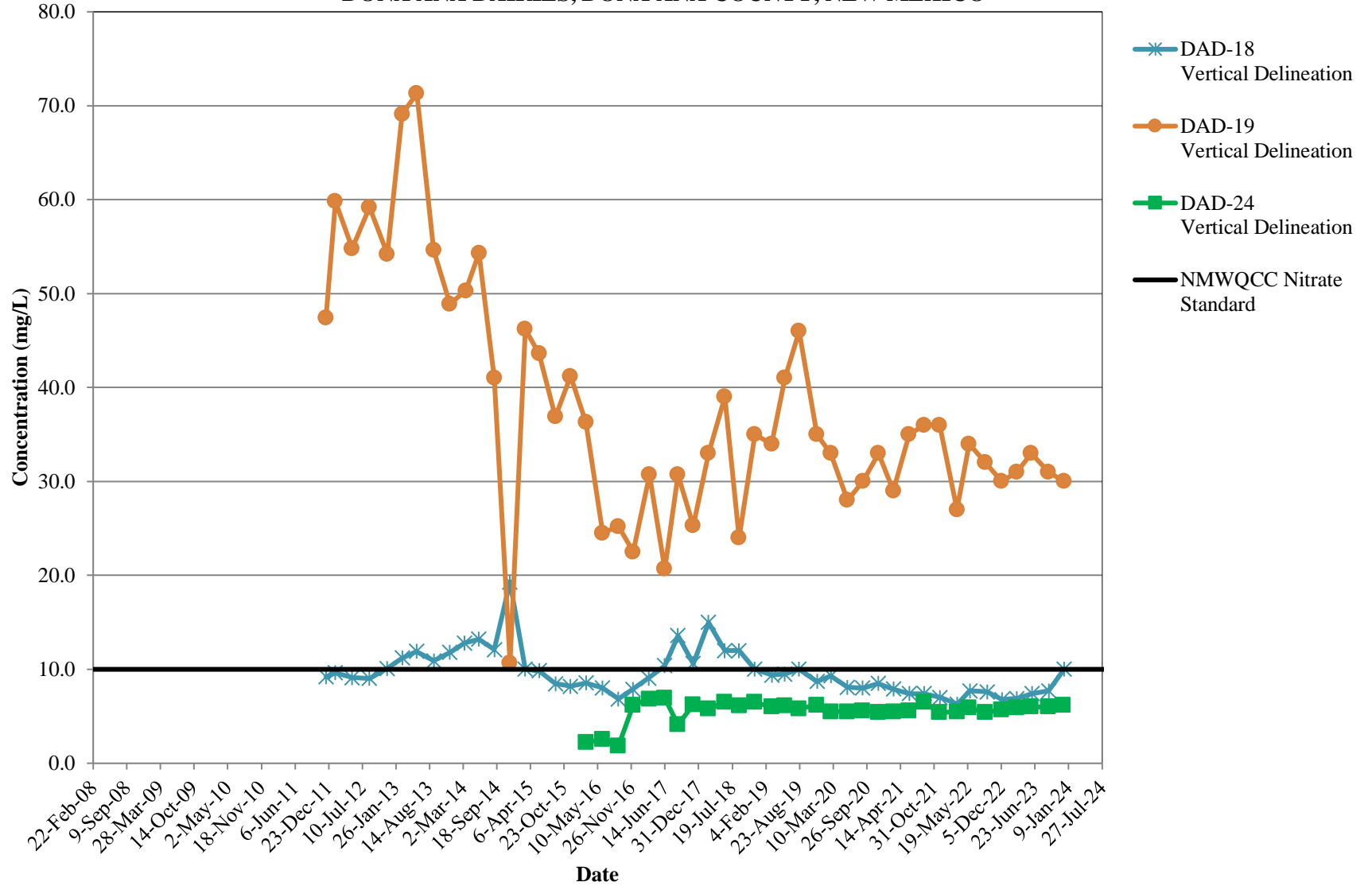

**NITRATE CONCENTRATION TRENDS
SOUTHERN ABATEMENT PLAN MONITORING WELLS
IN THE REGIONAL AQUIFER
DONA ANA DAIRIES, DONA ANA COUNTY, NEW MEXICO**

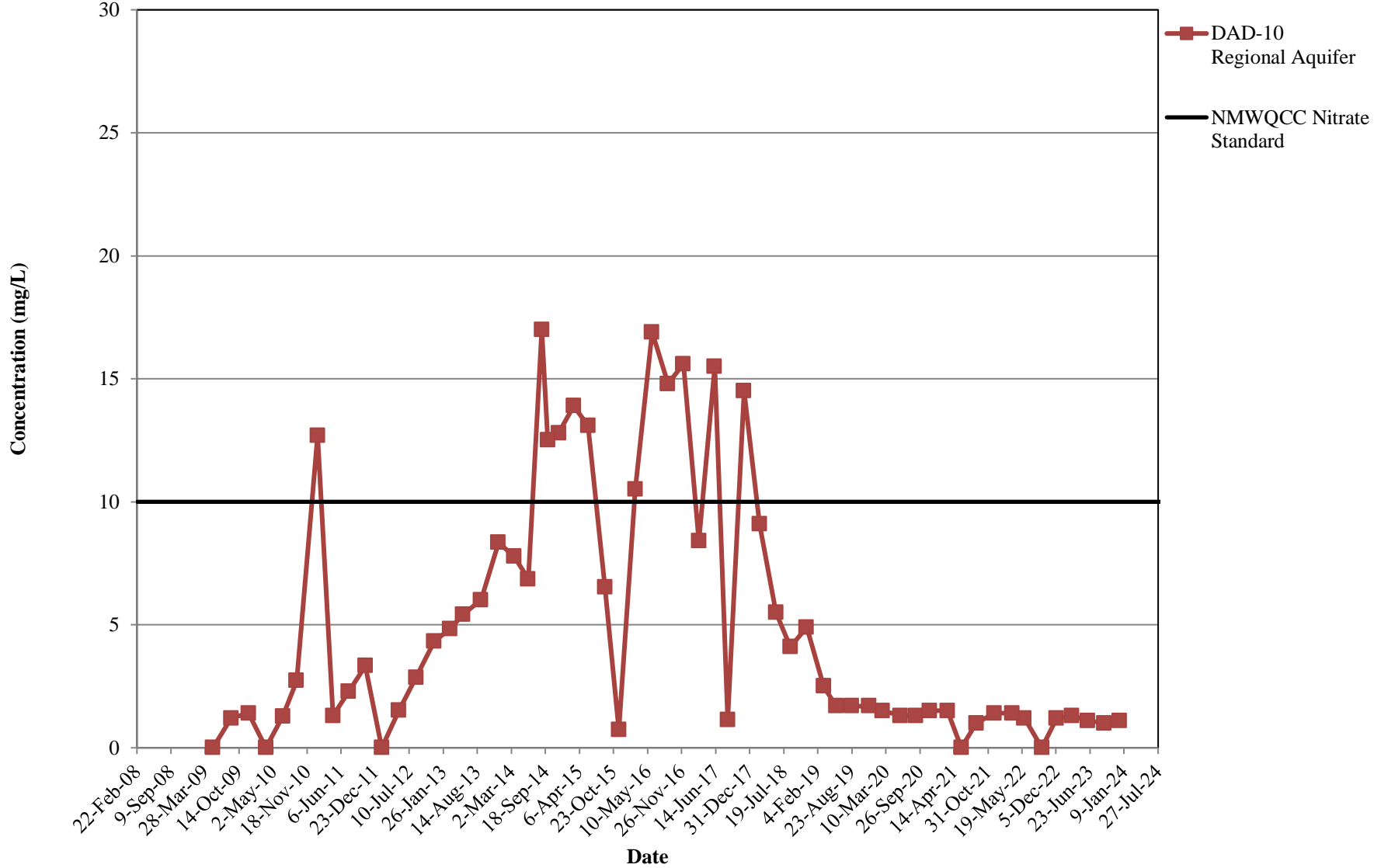

**NITRATE CONCENTRATION TRENDS
SOUTHERN ABATEMENT PLAN MONITORING WELLS
IN THE PERCHED AQUIFER
DONA ANA DAIRIES, DONA ANA COUNTY, NEW MEXICO**

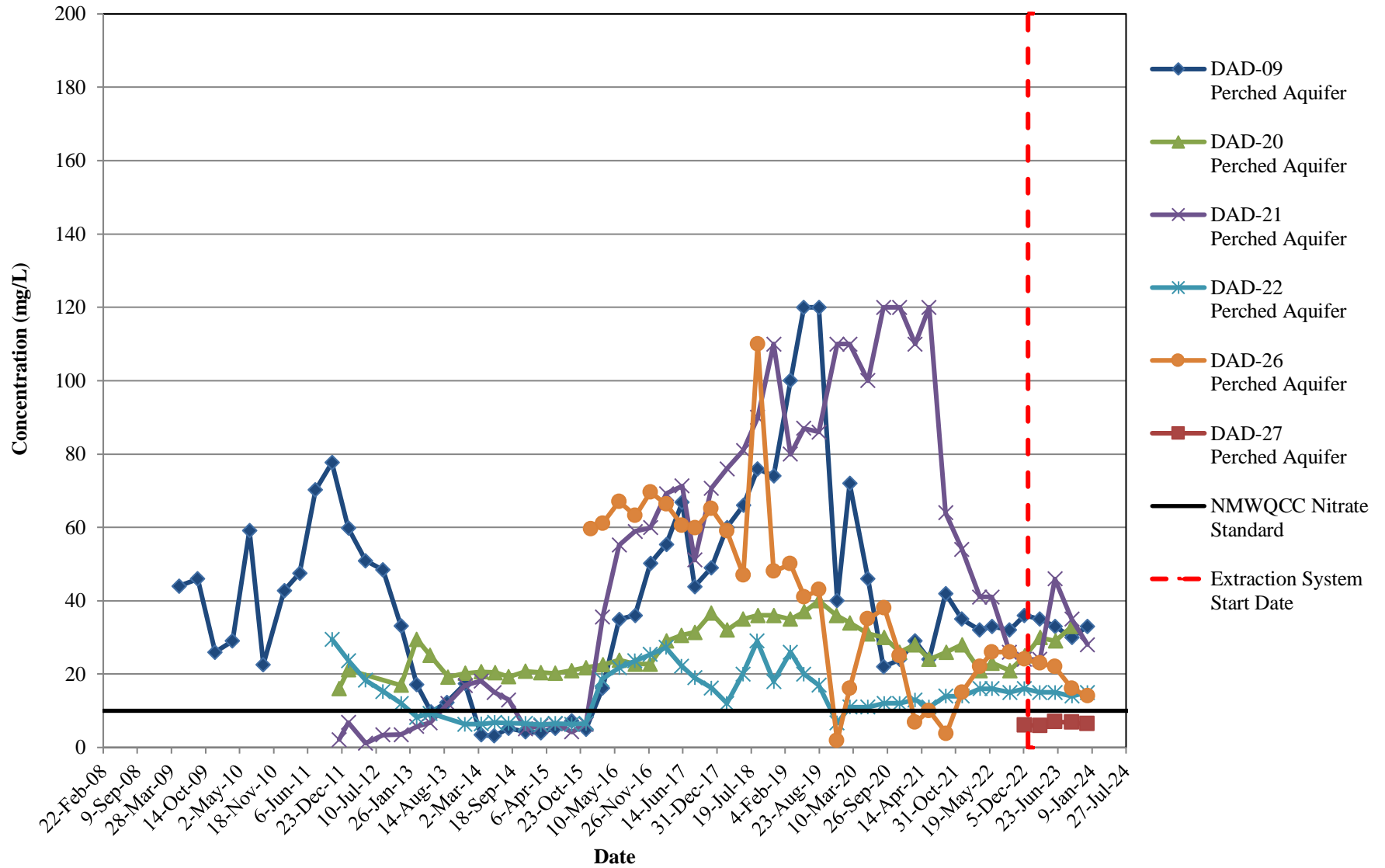

**CHLORIDE CONCENTRATION TRENDS
NORTHERN ABATEMENT PLAN MONITORING WELLS
DONA ANA DAIRIES, DONA ANA COUNTY, NEW MEXICO**

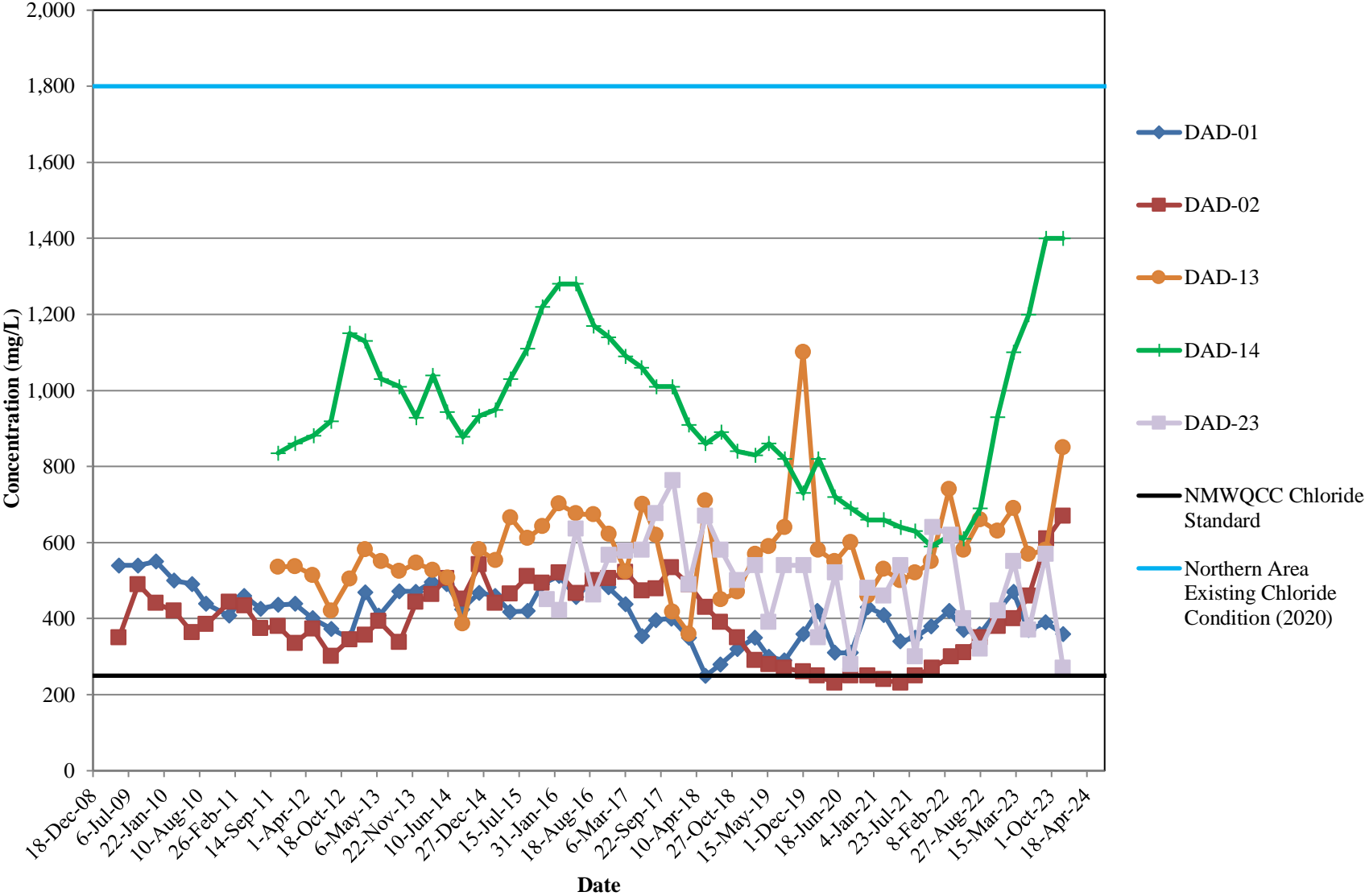

**CHLORIDE CONCENTRATION TRENDS
NORTHERN ABATEMENT PLAN MONITORING WELLS -
VERTICAL DELINEATION
DONA ANA DAIRIES, DONA ANA COUNTY, NEW MEXICO**

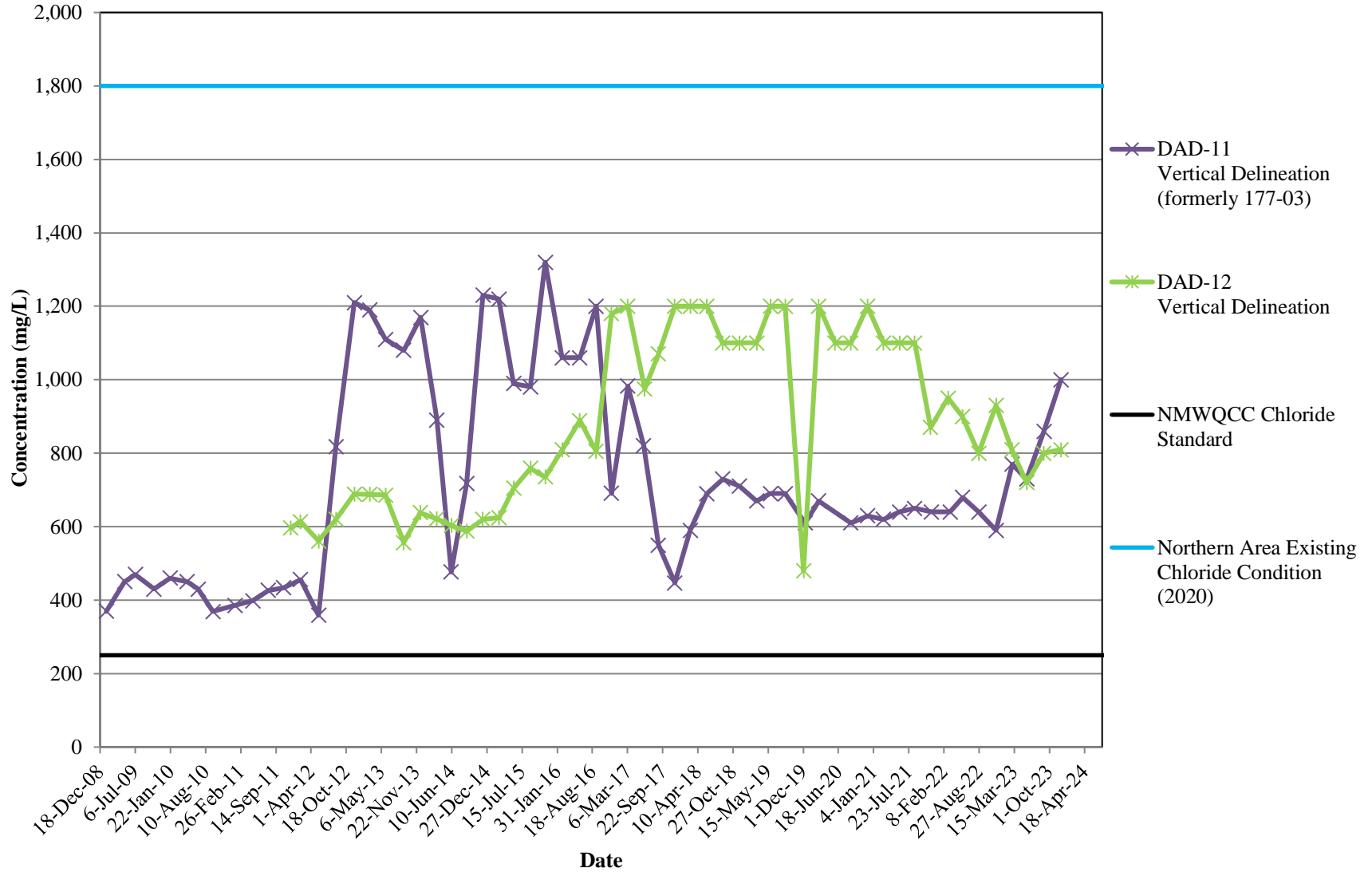

**CHLORIDE CONCENTRATION TRENDS
CENTRAL ABATEMENT PLAN MONITORING WELLS
DONA ANA DAIRIES, DONA ANA COUNTY, NEW MEXICO**

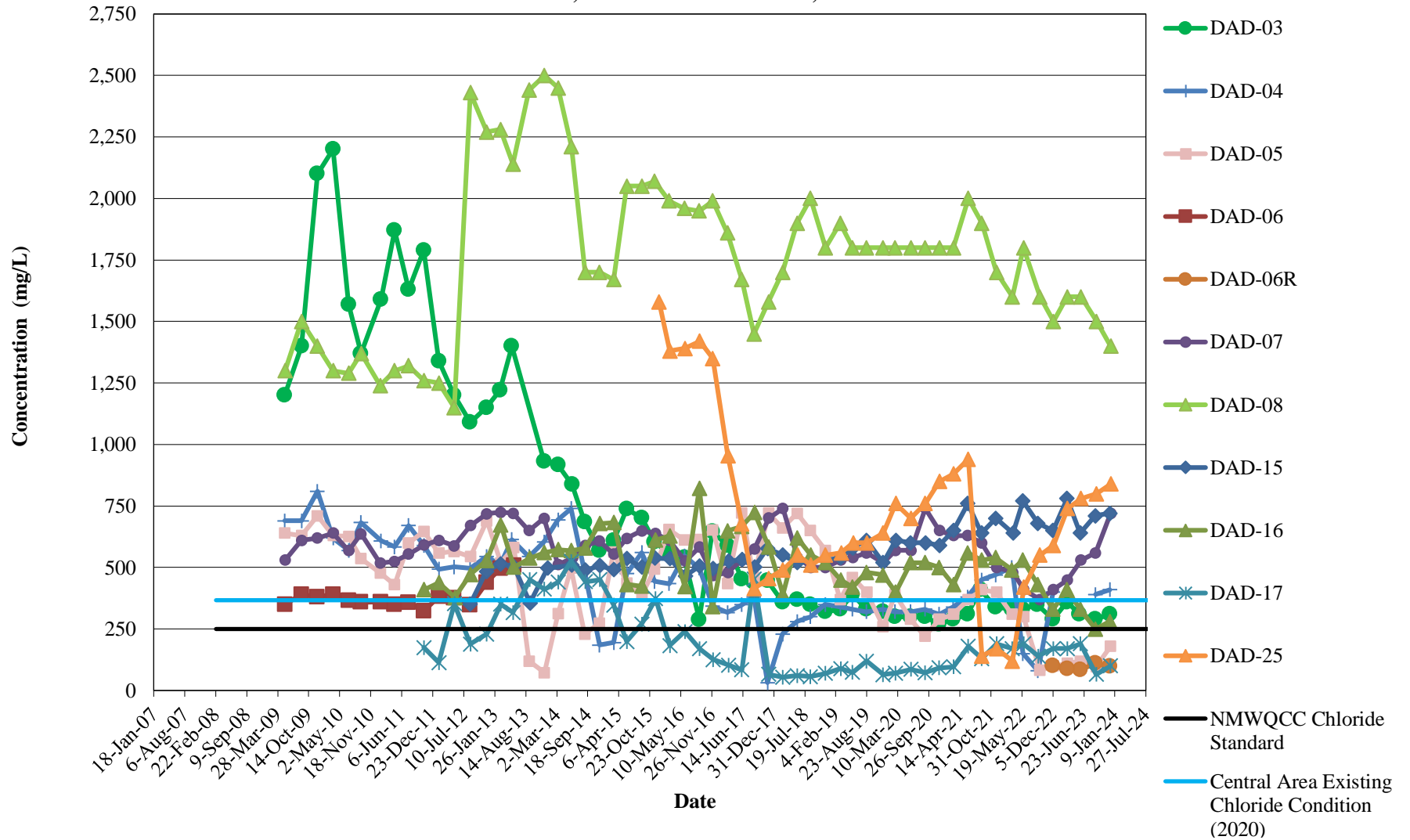

**CHLORIDE CONCENTRATION TRENDS
CENTRAL ABATEMENT PLAN MONITORING WELLS -
VERTICAL DELINEATION
DONA ANA DAIRIES, DONA ANA COUNTY, NEW MEXICO**

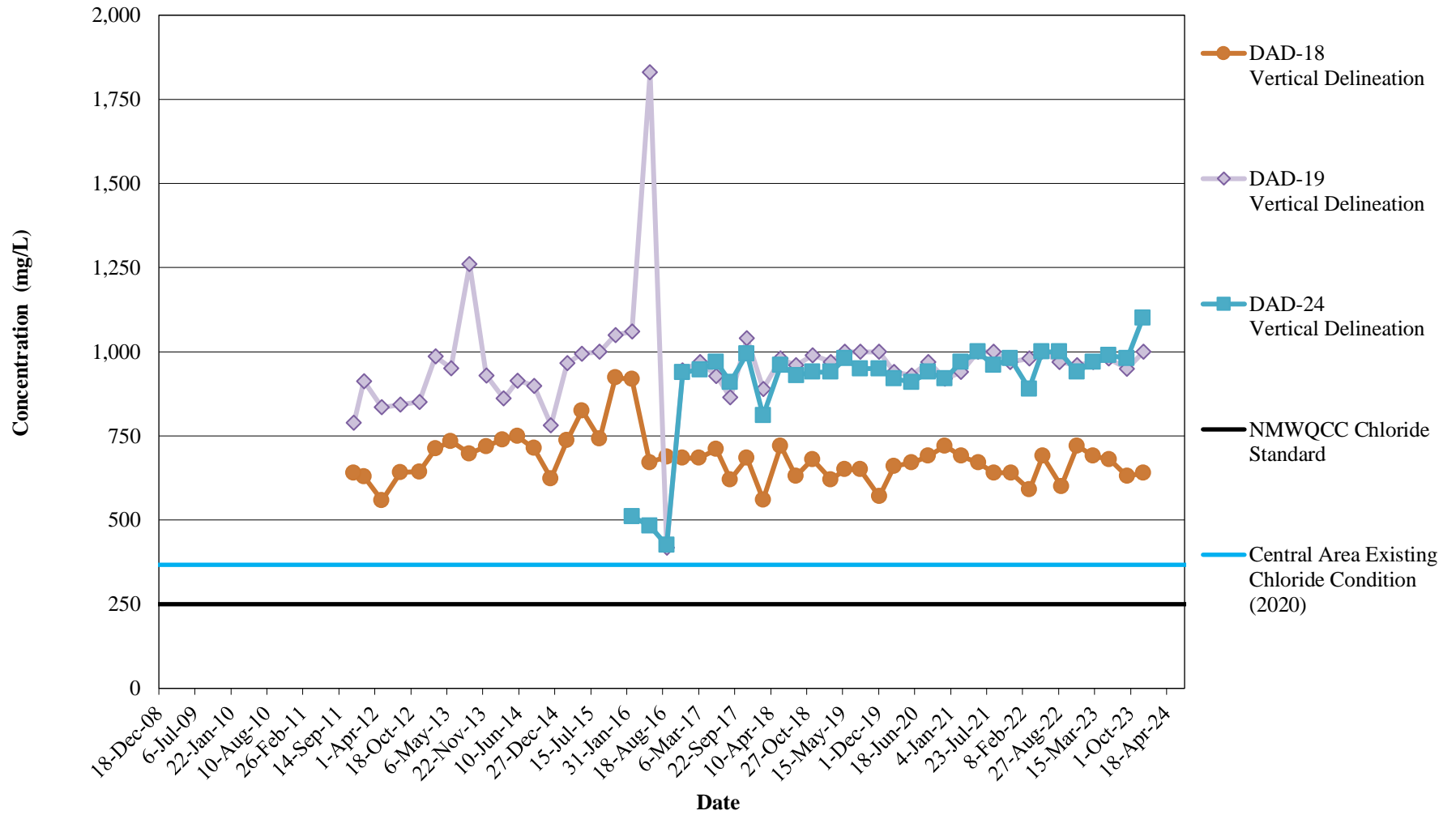

**CHLORIDE CONCENTRATION TRENDS
SOUTHERN ABATEMENT PLAN MONITORING WELLS
IN THE PERCHED AQUIFER
DONA ANA DAIRIES, DONA ANA COUNTY, NEW MEXICO**

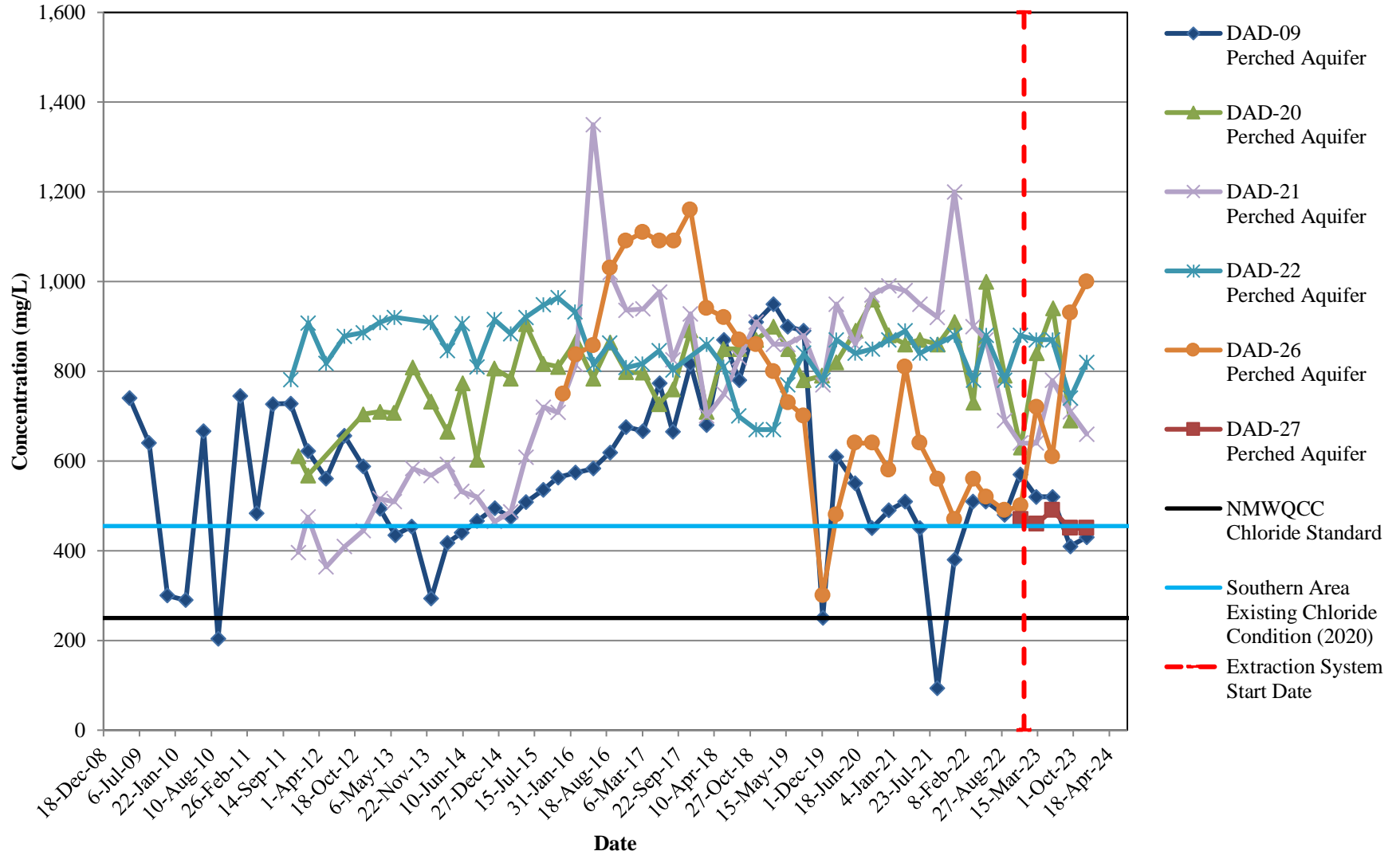

**CHLORIDE CONCENTRATION TRENDS
SOUTHERN ABATEMENT PLAN MONITORING WELLS
IN THE REGIONAL AQUIFER
DONA ANA DAIRIES, DONA ANA COUNTY, NEW MEXICO**

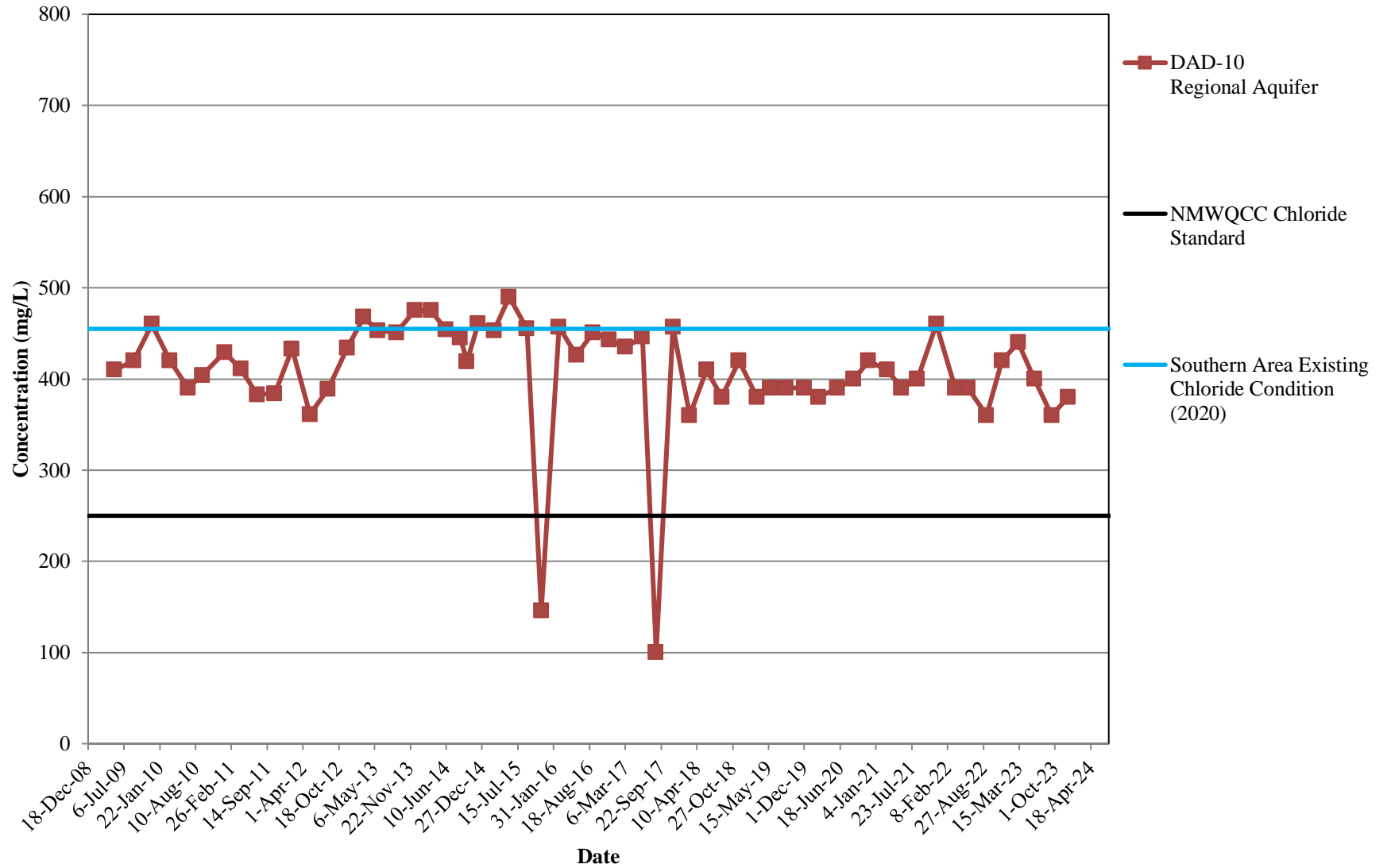

**TDS CONCENTRATION TRENDS
NORTHERN ABATEMENT PLAN MONITORING WELLS
DONA ANA DAIRIES, DONA ANA COUNTY, NEW MEXICO**

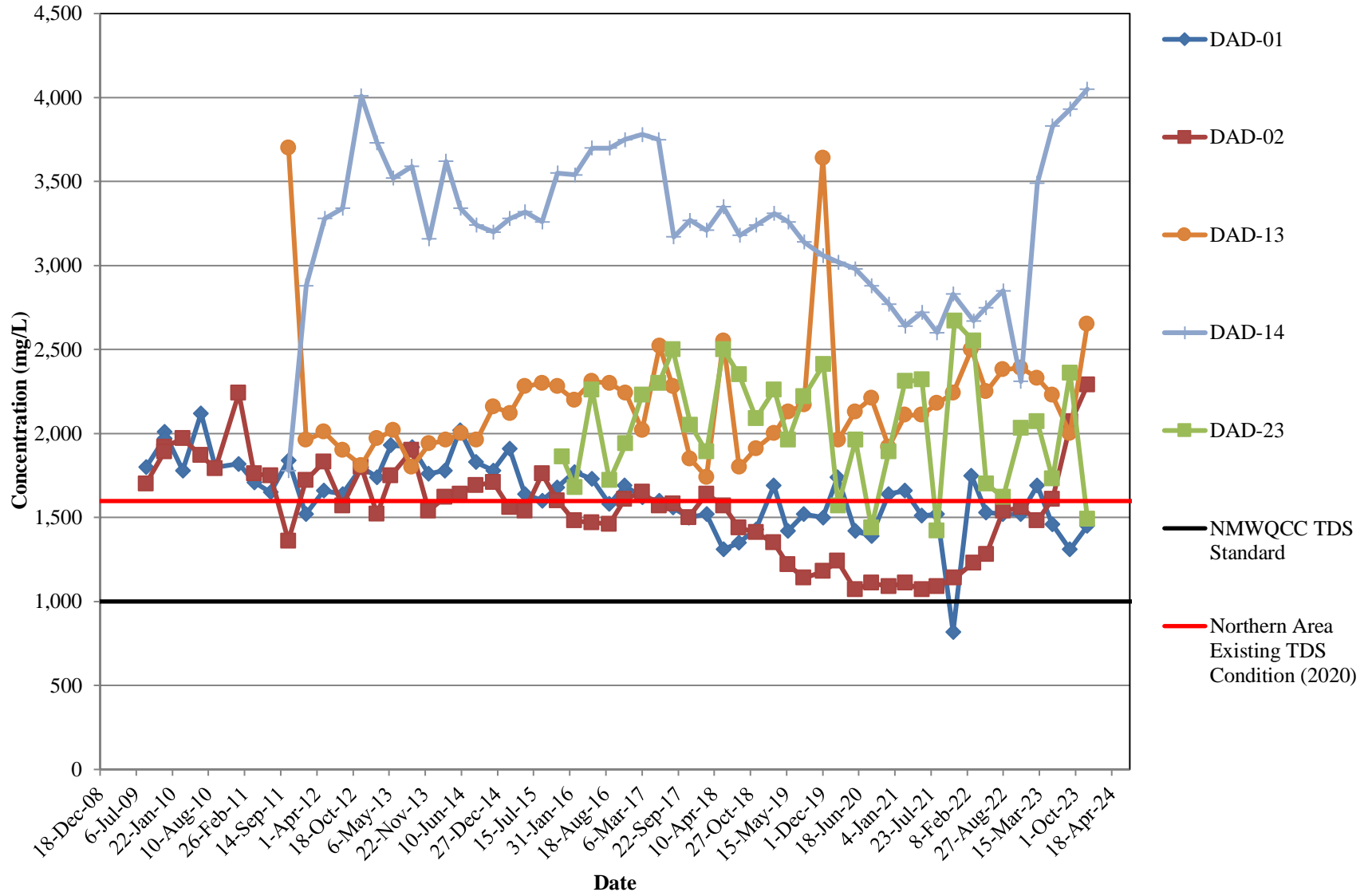

**TDS CONCENTRATION TRENDS
 NORTHERN ABATEMENT PLAN MONITORING WELLS -
 VERTICAL DELINEATION
 DONA ANA DAIRIES, DONA ANA COUNTY, NEW MEXICO**

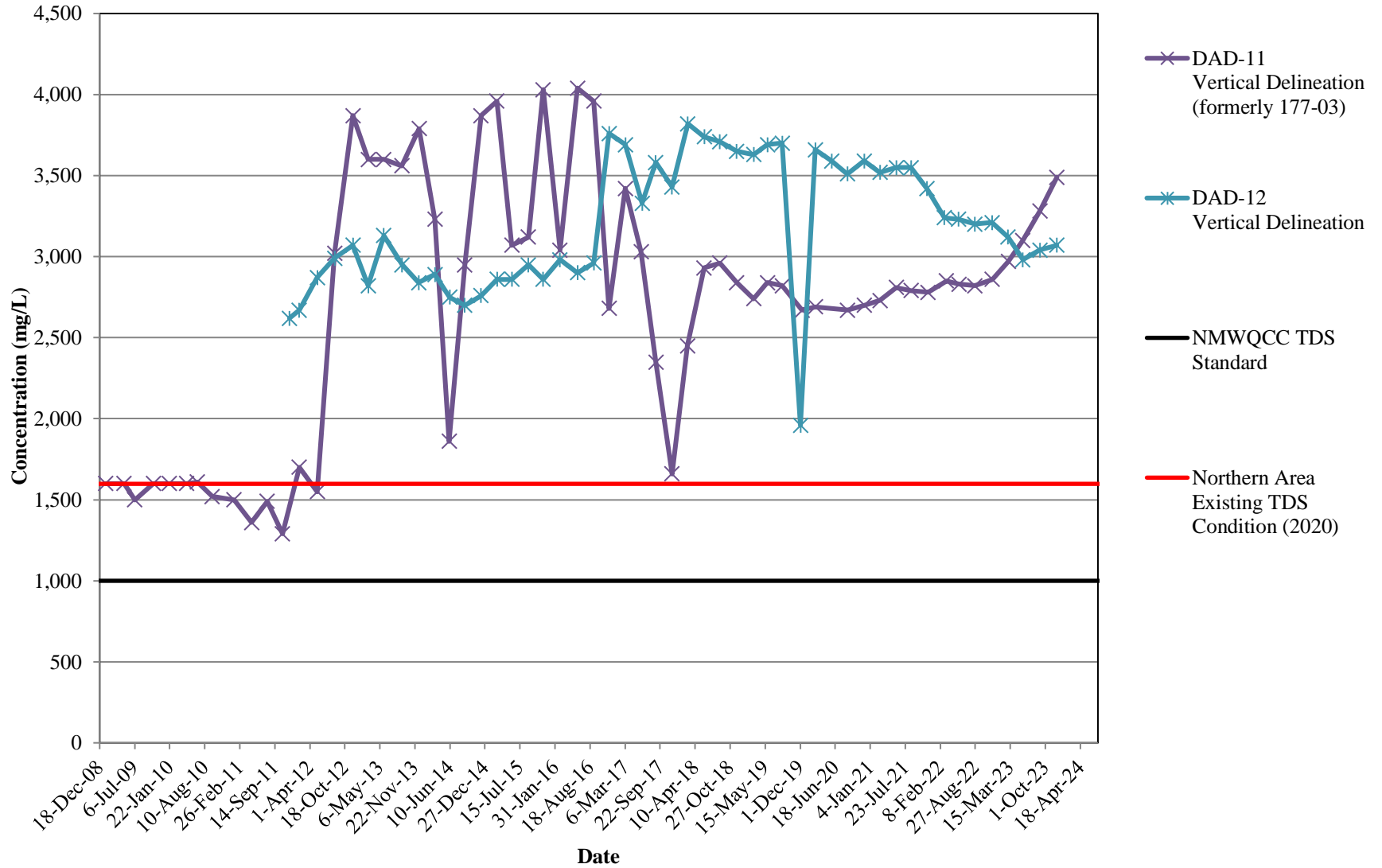

**TDS CONCENTRATION TRENDS
CENTRAL ABATEMENT PLAN MONITORING WELLS
DONA ANA DAIRIES, DONA ANA COUNTY, NEW MEXICO**

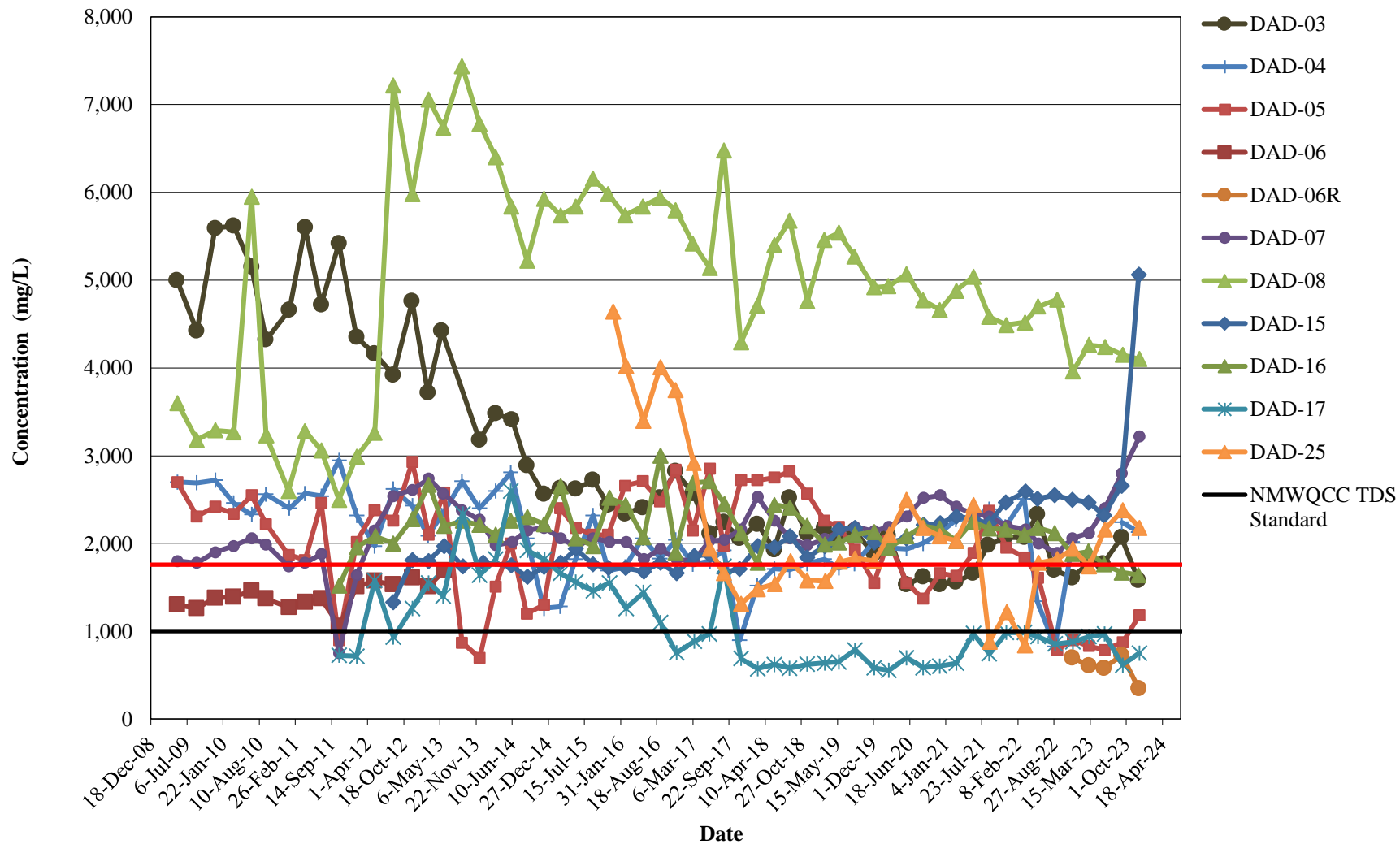

**TDS CONCENTRATION TRENDS
CENTRAL ABATEMENT PLAN MONITORING WELLS -
VERTICAL DELINEATION
DONA ANA DAIRIES, DONA ANA COUNTY, NEW MEXICO**

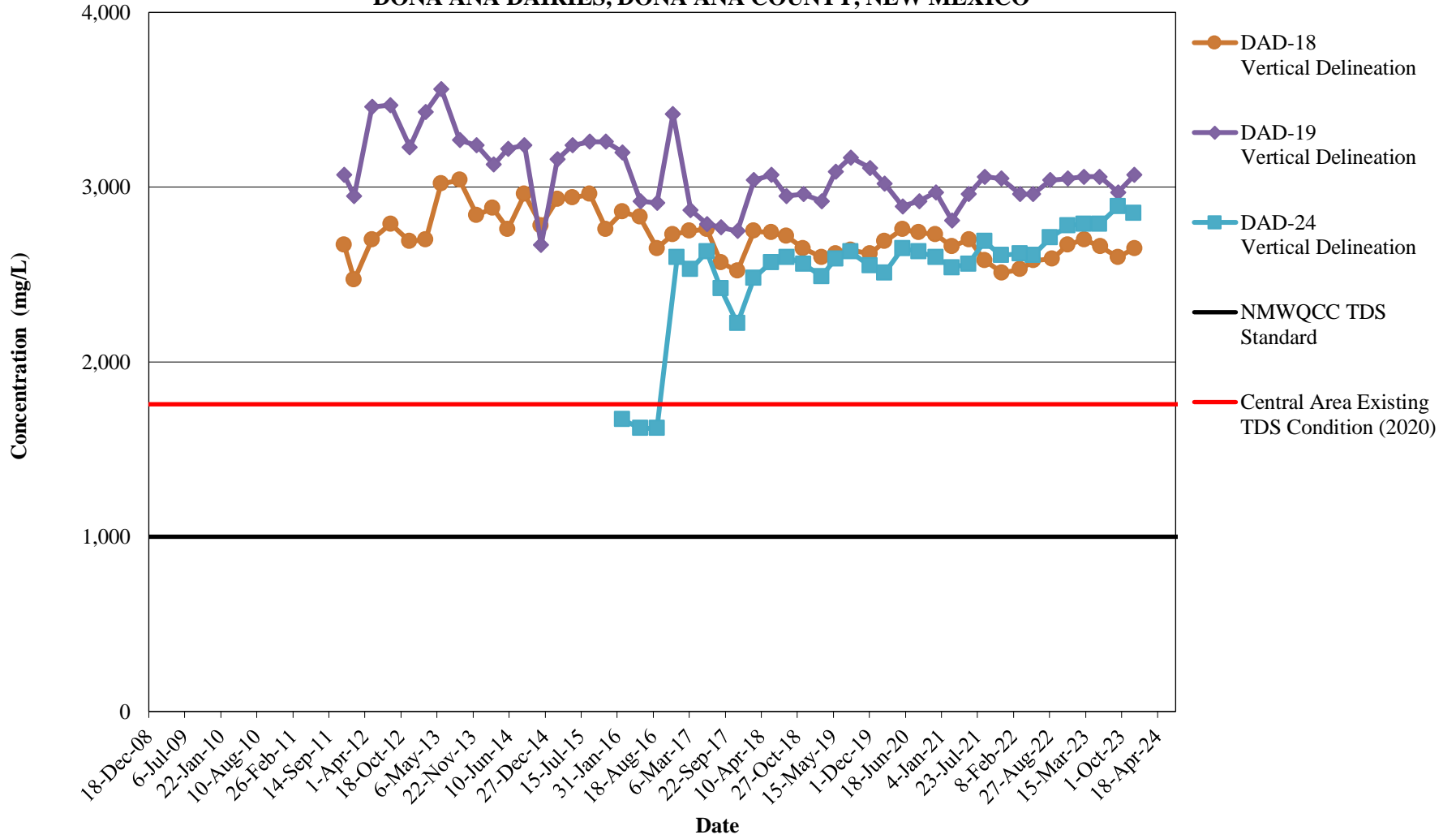

**TDS CONCENTRATION TRENDS
SOUTHERN ABATEMENT PLAN MONITORING WELLS
IN THE PERCHED AQUIFER
DONA ANA DAIRIES, DONA ANA COUNTY, NEW MEXICO**

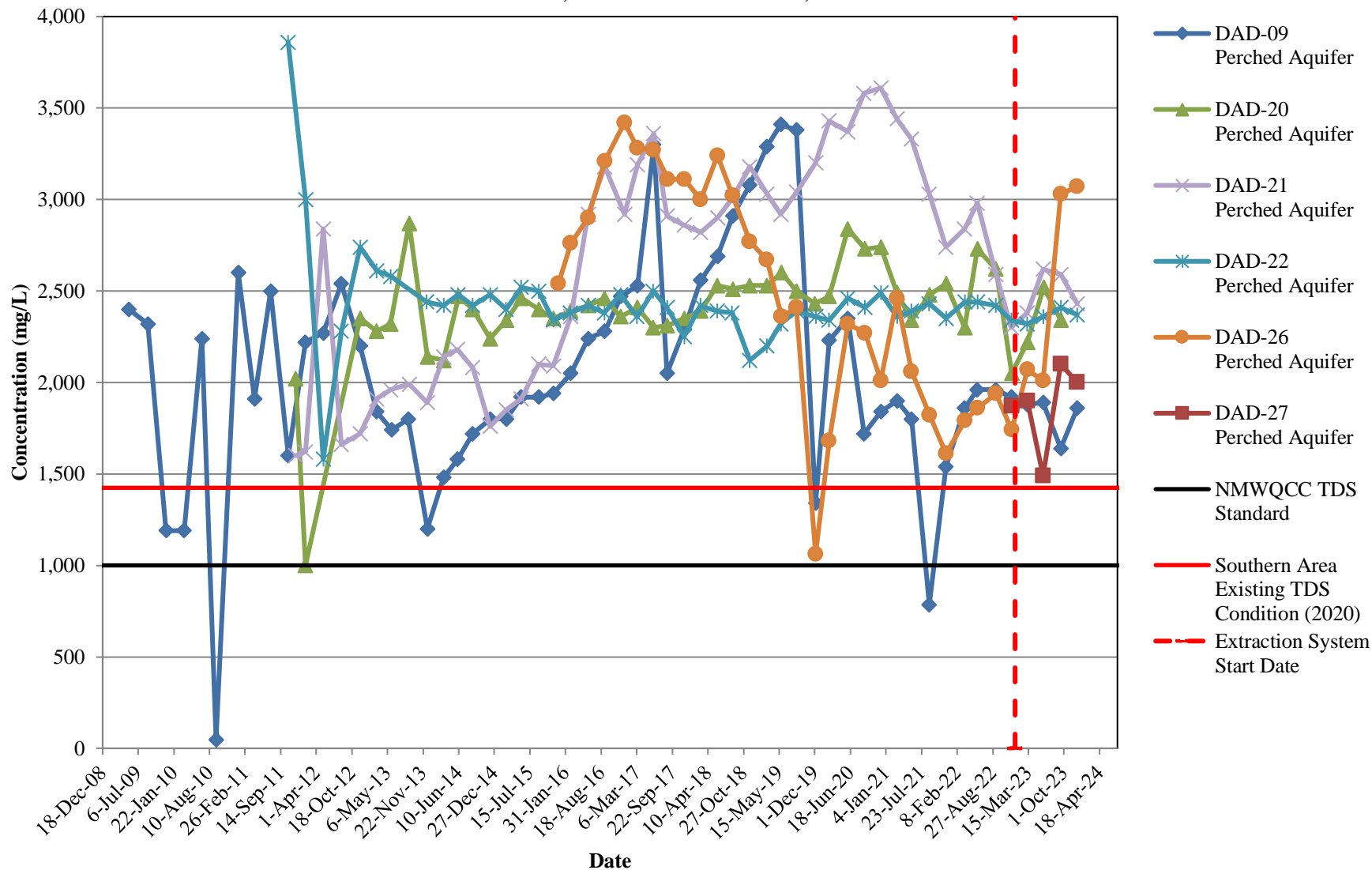

**TDS CONCENTRATION TRENDS
SOUTHERN ABATEMENT PLAN MONITORING WELLS
IN THE REGIONAL AQUIFER
DONA ANA DAIRIES, DONA ANA COUNTY, NEW MEXICO**

