



EA Engineering, Science, and Technology, Inc., PBC
320 Gold Avenue SW, Suite 1300
Albuquerque, New Mexico 87102
www.eaest.com

September 8, 2023

Mr. Jaben Richards
Ground Water Quality Bureau
New Mexico Environment Department
PO Box 5469
Santa Fe, NM 87502

Dear Mr. Richards:

On behalf of Doña Ana Dairies, Inc., EA Engineering, Science, and Technology, Inc., PBC is submitting this Quarterly Groundwater Monitoring Report for the dairies located in Mesquite, Vado, and Anthony, New Mexico. The report includes the Del Oro Dairy pump and reuse system performance assessment and the quarterly groundwater sampling event conducted to fulfill requirements of the Stage 2 Abatement Plan for Doña Ana Dairies.

Please let me know if you have any questions regarding the information provided in this report.

Sincerely,

A handwritten signature in blue ink, appearing to read 'Gina Mullen', is positioned above the printed name.

Gina Mullen
Project Manager

A handwritten signature in blue ink, appearing to read 'Jay Snyder', is positioned above the printed name.

Jay Snyder
Senior Hydrogeologist

Enclosure

Cc: Linda Armstrong, Doña Ana Dairies (electronic)
File



EA Engineering, Science, and Technology, Inc., PBC
320 Gold Avenue SW, Suite 1300
Albuquerque, New Mexico 87102
www.eaest.com

QUARTERLY GROUNDWATER
MONITORING REPORT
DOÑA ANA DAIRIES
MESQUITE, NEW MEXICO

Prepared for:

Doña Ana Dairies
Mesquite, New Mexico

Prepared by:

EA Engineering, Science,
and Technology, Inc., PBC
320 Gold Avenue SW, Suite 1300
Albuquerque, New Mexico 87102

September 2023

EA Project No. 21464112.02
21464111.02

QUARTERLY GROUNDWATER
MONITORING REPORT
DOÑA ANA DAIRIES
MESQUITE, NEW MEXICO

Prepared for:

Doña Ana Dairies
Mesquite, New Mexico

Prepared by:

EA Engineering, Science,
and Technology, Inc., PBC
320 Gold Avenue SW, Suite 1300
Albuquerque, New Mexico



Gina Mullen
Project Manager

September 8, 2023

Date

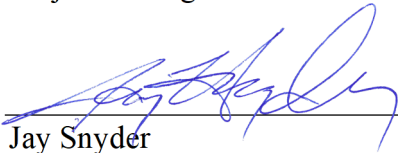

Jay Snyder
Senior Hydrogeologist

September 8, 2023

Date

September 2023

TABLE OF CONTENTS

<u>Section</u>		<u>Page</u>
1.0	INTRODUCTION	1
1.1	Objective and Monitoring Scope	1
1.2	Background.....	1
2.0	GROUNDWATER MONITORING ACTIVITIES	1
2.1	Monitoring Well Gauging.....	1
2.2	Groundwater Sampling	1
3.0	GROUNDWATER MONITORING RESULTS	2
3.1	Hydraulic Gradient and Direction of Groundwater Flow	2
3.2	Groundwater Field Parameters	2
3.3	Groundwater Analytical Results	3
3.3.1	Abatement Plan Monitoring Well Analytical Results	3
3.3.2	Abatement Plan and Discharge Plan Analytical Results by Area.....	3
4.0	CONCLUSION AND RECOMMENDATIONS	5
5.0	REFERENCES	7

LIST OF TABLES

(All Tables Provided Electronically via CD)

Table 1	Summary of Monitoring Well Fluid Gauging Data
Table 2	Summary of Monitoring Well Groundwater Field Parameters
Table 3	Summary of Sample Analytical Methods and Sampling Requirements
Table 4	Abatement Plan Monitoring Well Groundwater Analytical Results
Table 5	Discharge Plan Monitoring Well Groundwater Analytical Results

LIST OF FIGURES

Figure 1	Site Location Map
Figure 2	Potentiometric Surface Map, May 2023, Northern Portion
Figure 3	Potentiometric Surface Map, May 2023, Central Portion
Figure 4	Potentiometric Surface Map, May 2023, Southern Portion, Regional Aquifer
Figure 5	Potentiometric Surface Map, May 2023, Southern Portion, Perched Aquifer
Figure 6	Groundwater Analytical Results, May/June 2023, Northern Portion
Figure 7	Groundwater Analytical Results, May/June/July 2023, Central Portion
Figure 8	Groundwater Analytical Results, May/June 2023, Southern Portion, Regional Aquifer
Figure 9	Groundwater Analytical Results, May/June 2023, Southern Portion, Perched Aquifer

LIST OF APPENDICES

Appendix A	Del Oro Dairy Pump and Reuse System Performance Assessment
Appendix B	Gauging and Sampling Field Forms (Provided Electronically via CD)
Appendix C	Analytical Laboratory Reports (Provided Electronically via CD)
Appendix D	Hydrographs by Area
Appendix E	Field Parameter Trends by Area
Appendix F	Concentration Trends by Area – Abatement Plan Wells

1.0 INTRODUCTION

On behalf of Doña Ana Dairies (Dairies), EA Engineering, Science, and Technology, Inc., PBC (EA) has prepared this Quarterly Monitoring Report for Doña Ana Dairies located south of Las Cruces, New Mexico (Figure 1). The report was completed in accordance with the *Stage 2 Abatement Plan* and the *Sampling and Analysis Plan, Doña Ana Dairies, Doña Ana County, New Mexico* dated November 7, 2013, and August 11, 2008, respectively, and the *Conceptual Work Plan (CWP)* dated February 1, 2008. All were prepared to satisfy requirements stated in the New Mexico Administrative Code (NMAC), Title 20, Chapter 6, Part 2, Sections 4106 through 4110 (20.6.2.4106 – 20.6.2.4110 NMAC). The *Sampling and Analysis Plan* was approved by the New Mexico Environment Department (NMED) Ground Water Quality Bureau (GWQB) on September 25, 2008. On March 25, 2015, the stipulated agreement to additional requirements to the *Dona Ana Dairies Stage 2 Abatement Plan* was agreed upon by NMED, the Dairies, and the Rio Valle Concerned Citizens. The *Stage 2 Abatement Plan* was approved by NMED by Final Order on April 10, 2015. A *Stage 2 Abatement Plan Modification* was approved by NMED on April 26, 2022 (NMED 2022). Document references are provided in Section 5.0.

1.1 Objective and Monitoring Scope

The objectives of this monitoring program is to satisfy the requirements set forth in the *Stage 2 Abatement Plan* and the *Stipulated Agreement* and to satisfy the requirements set forth in 20.6.2.4110 NMAC.

The following work was performed to meet the objectives of the monitoring program:

- Representatives from D&H Petroleum and Environmental Services, Inc. (D&H) gauged discharge plan (DP) monitoring wells, abatement plan (AP) monitoring wells, and Anthony Waste Water Treatment Plant (WWTP) wells from May 1, 2023 through May 4, 2023. Organ Dairy wells were gauged by Glorieta Geosciences, Inc. (Glorieta) on May 24, 2023.
- From May 25, 2023 through July 3, 2023, D&H representatives collected groundwater samples from all AP and DP wells that contained sufficient water. The samples were analyzed for nitrate, chloride, total dissolved solids (TDS), and total Kjeldhal nitrogen (TKN). Field parameters including specific conductance, pH, temperature, oxidation reduction potential (ORP), and dissolved oxygen were monitored and recorded on field forms during sampling.

Additionally, a performance assessment was performed on the Del Oro pump and reuse system in compliance with the *Stage 2 Abatement Plan Modification Performance Plan for Dona Ana Dairies (EA 2022)*. The performance assessment is provided in Appendix A.

1.2 Background

In correspondence dated April 7, 2006, NMED required a *Stage 1 Abatement Plan* for 13 dairies in Doña Ana County, based on analytical results from DP monitoring of on-site compliance

monitoring wells that showed concentrations of nitrate, chloride and TDS exceeding ground water standards promulgated in New Mexico Water Quality Control Commission (NMWQCC) Regulations (20.6.2.3103 NMAC). The 13 dairies were:

1. Organ Dairy (Former Daybreak and Del Norte Dairy)
2. Mountain View Dairy
3. Buena Vista I Dairy
4. Bright Star Dairy
5. Dominguez 2 (Former D&J Dairy)
6. Dominguez Dairy
7. Gonzales Dairy
8. Buena Vista Dairy I and II
9. River Valley Dairy
10. Big Sky Dairy
11. Sunset Dairy
12. Desert Land Dairy
13. Del Oro Dairy

On October 30, 2006, the 13 dairies notified NMED that they had reached an agreement to work as a group and submit a joint response to NMED's request (Doña Ana Dairies, 2006). Currently the Doña Ana Dairies (DAD) consortium consists of 9 dairies with the departure from the group by Buena Vista I Dairy in 2011, River Valley Dairy in April 2019, and Gonzalez Dairy in October 2020.

The current DAD consortium is organized geographically into the northern area, central area and southern area. The northern area currently consists of Organ Dairy, Mountain View Dairy, Bright Star Dairy, Dominguez 2 Dairy, and Dominguez Dairy. The northern land application is also included in the northern area of DAD. Buena Vista Dairy and Gonzalez Dairy, though no longer members of the DAD consortium, are located within the northern area. The central area consists of Buena Vista Dairy II, Big Sky Dairy, and Sunset Dairy/Desert Land Dairy. Though no longer a member of the DAD consortium, River Valley Dairy is also located in the central area. The southern area includes only the Del Oro Dairy.

On December 11, 2006, on behalf of the Doña Ana Dairies, Golder Associates Inc. (Golder) submitted a Stage 1 and 2 Abatement Plan Proposal to address impacts to groundwater in the area containing the Dairies (Golder 2006).

The first major deliverable in the Abatement Plan Proposal was an Existing Data Report (EDR), created to combine all existing and historical data and practices of the constituent dairies. The EDR, submitted on February 1, 2008 (Golder 2008a), was intended to satisfy the DAD consortiums' commitment for compilation and submission of existing data identified in the Doña Ana Dairies response (Golder 2006) to the NMED requirement for Stage 1 Abatement Plans. Section 9 of the EDR outlined data gaps identified during the preparation of the report, as well as the actions recommended. To facilitate the discussion of the path forward after the submittal of the EDR and concurrent with the EDR submission, a conceptual work plan (CWP) was prepared (Golder 2008b).

A meeting was held on July 15, 2008 between the DAD consortium, Golder and NMED. During that meeting, plume maps presented in the EDR (Golder 2008a), new monitoring data, and knowledge of monitoring well locations and groundwater chemistry results at adjacent DP-regulated facilities were used to identify data gaps with respect to ground water flow direction

and plume delineation. The agreed upon data gaps yielded monitoring well locations (including contingency monitoring well locations) recorded in the meeting minutes (Golder 2008c) and depicted in the Sampling and Analysis Plan (SAP) dated August 8, 2008 (Golder 2008d). The SAP outlined the details of the field operations to be implemented for completion of data gaps, such that a Site Investigation Report (§4106.C.6 NMAC) and Stage 2 Abatement Plan (§4106.D NMAC) could be prepared.

Between February 2008 and December 2008, quarterly groundwater gauging was conducted concurrent to discussions with NMED at the DAD consortium to determine the current and historical site groundwater gradient.

In May 2009, field work was conducted as outlined in the SAP and ten AP monitoring wells (DAD-01 through DAD-10) were installed. In July 2009, the Site Investigation Report was submitted to the NMED (EA 2009).

On February 9, 2012, the Final Site Investigation Report was submitted to NMED (EA 2012a). The report summarized field activities that occurred from October 10 through October 14, 2011, and November 10 through 18, 2011, during which eleven soil borings were advanced at the site and converted into monitoring wells DAD-12 through DAD-14, DAD-16 through DAD-22, and DP well 177-03A.

On August 16, 2012, soil boring/monitoring well DAD-15 was installed and on August 20, 2012, well DAD-15 was sampled. An addendum to the Final Site Investigation Report was submitted to NMED on September 9, 2012 (EA 2012b), which summarized DAD-15 field activities.

A Stage 2 Abatement Plan was submitted to NMED on March 13, 2013 (EA 2013a). Based on an NMED response in August 2013, a Revision to the Stage 2 Abatement Plan was submitted on November 7, 2013 (EA 2013b).

On March 25, 2015, the stipulated agreement to additional requirements to the Doña Ana Dairies Stage 2 Abatement Plan was agreed to by NMED Doña Ana Dairies, and the Rio Valle Concerned Citizens. On April 10, 2015, the Stage 2 Abatement Plan with the stipulated agreement was approved by NMED by Final Order (NMED 2015).

EA began implementation of the Stage 2 Abatement Plan and stipulated agreement as directed by the Final Order in December 2015. To meet objectives, four monitoring wells were installed (DAD-23 through DAD-26) and Del Oro Dairy discharge plan (DP) well 692-01 was plugged and abandoned. Details on implementation of these tasks are included *Stage 2 Implementation and Quarterly Groundwater Monitoring Report* dated July 2016 (EA 2016).

In accordance with the approved Stage 2 Abatement Plan and stipulated agreement, a baseline compound specific isotope analysis for nitrogen 14 and nitrogen 15 ($^{15}\text{N}/^{14}\text{N}$ [$\delta^{15}\text{N}$]) and total organic carbon (TOC) was completed for 16 monitoring wells in spring of 2016. Additionally, existing conditions concentrations were recalculated for the contaminants of concern. Results of these analyses are presented in the *Stage 2 Implementation and Quarterly Groundwater Monitoring Report* dated July 2016 (EA 2016). A five-year review containing results of repeated

compound specific isotope analysis sampling and recalculated existing conditions concentrations was submitted to NMED in December 2020 (EA 2020a).

Contaminant concentration trend analysis as well as geospatial analysis to evaluate changes in plume behavior are required on an annual basis and are provided in the annual report. Additionally, the results of the annual sampling of irrigation and supply wells and concentration trends of analytes in AP and DP wells are provided in the annual report.

A Stage 2 Abatement Plan Modification proposal was submitted to NMED on August 10, 2018, to address plume instability in the perched aquifer nitrate plume at Del Oro Dairy. Following discussions with NMED, a revised Stage 2 Abatement Plan Modification proposal was submitted on May 1, 2019. A public meeting to discuss the plan was held in Anthony, New Mexico on May 17, 2019. The Stage 2 Abatement Plan Modification proposal was revised based on additional input from NMED and the public and submitted on July 26, 2019 (EA 2019). Public notice for the proposal was initiated on October 23, 2019, and closed on December 31, 2019. An addendum to the Stage 2 Abatement Plan Modification proposal was submitted on July 13, 2020 (EA 2020b). A revised addendum to the Stage 2 Abatement Plan Modification proposal was submitted on July 13, 2021, based on additional comments from the public (EA 2021). An additional virtual townhall meeting was held on December 15, 2021, that presented the current proposal. The performance plan was submitted to NMED on February 15, 2022 (EA 2022). NMED approved the Stage 2 Abatement Plan Modification for Doña Ana Dairies (EA 2019), the accompanying Stage 2 Abatement Plan Addendum for Reuse of Pumped Groundwater at Del Oro Dairy (EA 2021), and the Stage 2 Abatement Plan Modification Performance Plan (EA 2022) on April 26, 2022 (NMED 2022). Implementation is detailed in the Stage 2 Abatement Plan Modification Completion Report (EA 2023). The quarterly performance assessment of the Del Oro Dairy pump and reuse system, as required by Stage 2 Abatement Plan Modification Performance Plan (EA 2022) is provided in Appendix A.

2.0 GROUNDWATER MONITORING ACTIVITIES

Groundwater monitoring activities included gauging AP monitoring wells, DP monitoring wells for dairies that are a part of the DAD consortium, and the Anthony WWTP monitoring wells. Groundwater samples were collected from AP monitoring wells and DP monitoring wells for dairies that are a part of the DAD consortium. The DAD consortium currently consists of the following dairies: Big Sky, Bright Star, Buena Vista 2, Del Oro, Dominguez, Dominguez 2, Mountain View, Organ, and Sunset/Desert Land. Groundwater samples were analyzed for nitrate, chloride, TDS, and TKN. The resulting data from this groundwater monitoring event are compiled and presented below.

2.1 Monitoring Well Gauging

From May 1, 2023, through May 4, 2023, representatives from D&H gauged DP monitoring wells, AP monitoring wells, and Anthony WWTP wells with an electronic water level indicator. Organ Dairy wells were gauged by Glorieta on May 24, 2023. Table 1 provides a summary of the groundwater gauging data collected from the monitoring network. Data obtained during gauging are shown on potentiometric surface maps included as Figures 2, 3, 4, and 5. Well gauging field forms are available in Appendix B.

2.2 Groundwater Sampling

D&H collected groundwater from all AP monitoring wells with sufficient water from May 25, 2023, through June 9, 2023. Well DAD-06 has been dry since August 2013 and was plugged and abandoned in November 2022 (EA 2023). Groundwater sampling from AP wells was accomplished with new, disposable bailers and twine. Three well casing volumes were purged unless the well contained insufficient water.

D&H collected groundwater from the DP wells from May 4, 2023, through July 3, 2023. Glorieta collected groundwater from Organ Dairy DP wells on May 24, 2023. Prior to sampling, all DP wells were purged of three well casing volumes, if practicable, by (1) hand-bailing with new, disposable bailers and twine, (2) pumping with a submersible pump and new polyethylene tubing, or (3) pumping with a dedicated pump and new polyethylene tubing. Several DP wells and one AP well (DAD-04) were dry or contained insufficient water for sampling. Organ Dairy wells 126-04, 126-05, 126-07, and 126-09 contained insufficient water and were not sampled. Sunset/Desert Land Dairy well 257-03 has an unknown blockage and could not be sampled. Bright Star well 340-02 and Del Oro Dairy well 692-04 were dry.

The wells were sampled from historically clean to dirty to the extent possible to minimize cross-contamination potential. All non-dedicated or disposable equipment was decontaminated between wells with an Alconox™ solution to further ensure sample quality. All meters were calibrated and/or checked with standards in accordance with the manufacturer's specifications prior to daily use. Purge water was ground discharged.

When sufficient water was available, field parameters including specific conductance, temperature, pH, ORP, and dissolved oxygen were monitored using a water quality meter and data were recorded on field forms. Dissolved oxygen and ORP were only measured in the first

set of readings. Field parameters from August 2015 to present are summarized in Table 2. The sampling field forms are presented in Appendix B.

All groundwater samples were collected immediately after purging. Sampling was either accomplished by carefully pouring groundwater from the bailer into the sample containers or by pumping groundwater through new polyethylene tubing into the sample container. Sample containers were provided by Hall Environmental Analysis Laboratory, Inc. (Hall). Container size, type, sample preservatives, analytical methods, and holding times are specified in Table 3. All samples were preserved in accordance with method requirements, labeled, then immediately cooled to $<6^{\circ}\text{C}$ with ice and delivered under chain-of-custody to Hall in Albuquerque, New Mexico. All analytical laboratory reports are provided in Appendix C.

3.0 GROUNDWATER MONITORING RESULTS

3.1 Hydraulic Gradient and Direction of Groundwater Flow

During the past quarter, groundwater was present beneath the site at depths ranging from 14.93 feet below top-of-casing (ft btoc) in Sunset well 257-03 to 135.42 ft btoc in Dominguez 2 well 42-12. Groundwater was encountered at shallower depths near the Mesquite Drain and at greater depths near I-10 where the topographic elevation increases.

AP monitoring well DAD-25 may have been completed in a perched aquifer, as groundwater elevations have consistently measured several feet higher than groundwater elevations in surrounding wells. As a result, this groundwater elevation has not been used in contouring for the central area potentiometric surface map.

Potentiometric surface maps of groundwater elevation were completed using monitoring well gauging data for the northern, central, and southern areas (perched and regional aquifers) of the Dairies. Groundwater elevation data are provided in Table 1 and potentiometric surface maps are provided as Figures 2 through 5. Hydrographs were completed for select monitoring wells in each area and are provided in Appendix D. On average, regional aquifer groundwater elevations decreased by 0.75, 0.69 and 0.53 feet in the northern, central, and southern areas, respectively compared to the previous quarter. In the southern perched aquifer, groundwater elevations decreased by an average of 0.28 feet.

During the most recent gauging event, groundwater flow direction in the northern area was to the east except in the southern portion of the northern area where groundwater flowed to the southeast. Groundwater flow direction in the central and southern regional aquifers was generally to the southeast. Flow direction in the southern perched aquifer was to the south.

The hydraulic gradient across the Dairies in the northern, central, and southern portions of the regional aquifer was approximately 0.001 ft/ft and the hydraulic gradient in the perched aquifer in the southern area was approximately 0.004 ft/ft.

3.2 Groundwater Field Parameters

Field parameters from the most recent monitoring event (specific conductance, pH, temperature, ORP, and dissolved oxygen) were recorded on the sampling field forms provided in Appendix B and are summarized in Table 2. Specific conductance, dissolved oxygen, and ORP trends for select wells are presented in Appendix E. Though dissolved oxygen and ORP measurements from wells containing a dedicated pump were recorded, these measurements are not considered representative of aquifer conditions. As noted in Section 2.2, dissolved oxygen and ORP are only recorded in the first set of readings. This is because hand bailing agitates the aquifer and the ORP and dissolved oxygen measurements are not considered representative once agitation begins.

3.3 Groundwater Analytical Results

3.3.1 Abatement Plan Monitoring Well Analytical Results

Groundwater analyte concentrations were below the 10 milligrams per liter (mg/L) NMWQCC standard for nitrate as nitrogen in 11 of the 26 AP monitoring wells sampled. Groundwater collected from the following 15 AP wells had nitrate concentrations above the standard: DAD-01, DAD-07, DAD-08, DAD-09, DAD-11 (vertical delineation well), DAD-12 (vertical delineation well), DAD-13, DAD-14, DAD-15, DAD-19 (vertical delineation well), DAD-20, DAD-21, DAD-22, DAD-23, and DAD-26.

Nitrate concentrations decreased or were the same in groundwater collected from AP wells DAD-01, DAD-02, DAD-03, DAD-05, DAD-08, DAD-09, DAD-10, DAD-12, DAD-13, DAD-15, DAD-16, DAD-17, DAD-20, DAD-22, DAD-23, and DAD-26 compared to the previous sampling event. The largest decrease in nitrate concentration was observed in well DAD-01, which decreased from 16 mg/L in March 2023 to 13 mg/L in May 2023. The largest nitrate concentration increase was observed in well DAD-21 which increased from 24 mg/L in March 2023 to 46 mg/L in June 2023. During this sampling event, nitrate concentrations in groundwater collected from AP wells ranged from 60 mg/L in well DAD-14 to below the laboratory reporting limit of 1.0 mg/L in wells DAD-03, DAD-05, DAD-16, and DAD-17.

Both chloride and TDS concentrations equaled or exceeded their respective NMWQCC standards in most AP wells. Exceptions include wells DAD-05, DAD-06R, and DAD-17, where both chloride and TDS groundwater concentrations were below the 250 mg/L and 1,000 mg/L standards, respectively. The highest chloride and TDS concentrations in the AP wells were found in well DAD-08, where respective concentrations were 1,600 mg/L and 4,240 mg/L.

Table 4 and Figures 6 through 9 present the analytical results for AP monitoring wells. Analytical laboratory reports are provided in Appendix C. Nitrate, chloride, and TDS concentration trends for select AP wells are presented by area in Appendix F.

3.3.2 Abatement Plan and Discharge Plan Analytical Results by Area

DP groundwater analytical results are presented in Table 5. Nitrate, chloride, and TDS concentration trends for the AP wells by area are presented in Appendix F. Analytical data for all sampled wells are plotted on Figures 6 through 9. Analytical laboratory reports are included in Appendix C. Discussions of upgradient/downgradient conditions in the following section are

based on groundwater flow directions presented in Section 3.1. The following discussions summarize the results by area at the Dairies.

Northern Portion

Groundwater collected from upgradient well 86/340-01 (located north of the abatement area) has been below the nitrate NMWQCC standard of 10 mg/L since February 2018; historically, groundwater concentrations in this well were consistently above the nitrate standard. Northern Land Application Area well 70/86/340-01, located at the northern-most boundary of the abatement area, contained groundwater above the nitrate standard in May 2023 at a concentration of 24 mg/L. Organ Dairy well 126-12, Dominguez Dairy 2 well 42-02, and Dominguez Dairy 624-02 delineate the western edge of the plume. The nitrate plume is defined to the east by Dominguez Dairy wells 42-10, 42-11, and 42-12 and AP wells DAD-01 and DAD-13, which are just over the standard. Delineation is provided by AP well DAD-02 to the south. The highest nitrate concentration in the northern portion was observed in Dominguez Dairy well 42-06 with a concentration of 91 mg/L.

The chloride and TDS concentrations in DP wells were at or above the 250 mg/L standard in all wells sampled within the northern portion of the Dairies. The highest concentrations of chloride and TDS were observed in Northern Land Application area well 70/86/340-01 at concentrations of 1,900 mg/L and 6,060 mg/L, respectively.

Central Portion

The northern extent of the central portion nitrate plume is defined by Buena Vista Dairy II well 74-03 where nitrate concentrations were not detected above the laboratory detection limit. The southern extent is defined by Las Cruces Community Farms (formerly McAnally Enterprises) well MW-4, where nitrate concentrations were not detected above the laboratory detection limit in May 2023. Historically, the eastern cross-gradient extent of the plume was defined by wells DAD-07 and DAD-15. In the most recent sampling event, nitrate concentrations in groundwater collected from these wells exceeded the standard at 25 mg/L and 15 mg/L, respectively. The eastern edge of the nitrate plume is currently delineated by AP well DAD-06R, at a concentration of 6.4 mg/L. The western extent is defined by Buena Vista Dairy well 74-02 (1.3 mg/L) and AP wells DAD-16 and DAD-05; nitrate concentrations remain below standard in these AP wells. The highest nitrate concentration in the central portion was 110 mg/L, observed in Big Sky Dairy well 833-09.

Chloride and TDS concentrations were generally at or above standards in wells within the central portion of the Dairies. Chloride was below the standard in AP wells DAD-05, DAD-06R and DAD-17, at respective concentrations of 120 mg/L, 84 mg/L, and 190 mg/L. TDS was below the standard in AP wells DAD-05, DAD-06R, and DAD-17 at concentrations of 785 mg/L, 580 mg/L, and 968 mg/L, respectively. The highest chloride concentration was observed at AP well DAD-08 at 1,600 mg/L. The highest TDS concentration of 4,700 mg/L was detected at Las Cruces Community Farms well MW-4.

Southern Portion – Regional and Perched Aquifers

Wells completed in the regional aquifer in the southern portion of the dairies include AP well

DAD-10 and Del Oro wells 692-05 through 692-10 (Figure 8). All of the groundwater collected from wells in the regional aquifer contained nitrate below the NMWQCC standard except for Del Oro well 692-05 (14 mg/L).

Chloride concentrations were detected above the NMWQCC standard and ranged from 360 mg/L in Del Oro Dairy well 692-08 to 630 mg/L in Del Oro Dairy well 692-10. TDS concentrations ranged from 1,290 mg/L in DP well 692-08 to 1,520 mg/L in Del Oro Dairy well 692-10.

Wells completed in the perched aquifer in the southern portion that are sampled on a quarterly basis by DAD include wells 692-02, 629-04, DAD-09, DAD-20, DAD-21, DAD-22, DAD-26, and DAD-27 (Figure 9). Groundwater nitrate concentrations were above the standard in all monitoring wells in the perched aquifer except downgradient well DAD-27 (7.0 mg/L). The highest nitrate concentration was detected at AP well DAD-21 (46 mg/L). The concentration of nitrate in groundwater collected from downgradient AP wells DAD-20, DAD-22, and DAD-26 are 29 mg/L, 15 mg/L, and 22 mg/L, respectively. The nitrate plume is delineated to the southwest by AP well DAD-27.

Chloride concentrations in the perched aquifer ranged from 440 mg/L in Del Oro well 692-02 to 940 mg/L in AP well DAD-20. TDS in the perched aquifer ranged from 1,490 mg/L in AP well DAD-27 to 2,620 mg/L in AP well DAD-21.

4.0 CONCLUSION AND RECOMMENDATIONS

This groundwater monitoring event included the gauging of all accessible DP and AP wells and sampling of all accessible wells that contained sufficient water. Based on the data collected, the following conclusions and recommendations are presented:

- Depth to groundwater ranged from 14.93 feet btoc in Sunset well 257-03 to 135.42 ft btoc in Dominguez 2 well 42-12.
- On average, regional aquifer groundwater elevations decreased by 0.75, 0.69 and 0.53 feet in the northern, central, and southern areas, respectively compared to the previous quarter. In the southern perched aquifer, groundwater elevations decreased by an average of 0.28 feet.
- During the most recent gauging event, groundwater flow direction in the northern area was to the east except in the southern portion of the northern area where groundwater flowed to the southeast. Groundwater flow direction in the central and southern regional aquifers was generally to the southeast. Flow direction in the southern perched aquifer was to the south.
- The hydraulic gradient across the Dairies in the regional aquifer was approximately 0.001 ft/ft. The hydraulic gradient in the southern perched aquifer was approximately 0.004 ft/ft.
- Nitrate was below the NMWQCC standard of 10 mg/L in 11 of the 26 groundwater samples collected from the AP wells.

- Chloride and TDS generally remain at or above standards in regional aquifer wells upgradient of the northern, central, and southern portions of the plumes at the Dairies.

5.0 REFERENCES

- Doña Ana Dairies. 2006. Letter Regarding Agreement for Joint Stage 1 and Stage 2 Abatement Plan and Storm Water and Wastewater Pond Upgrades. Letter from Mr. Michael Weatherly, Chairman, Doña Ana Dairies, to Mr. William Olson, Chief, Ground Water Quality Bureau. 30 October.
- EA. 2009. *Site Investigation Report, Doña Ana Dairies, Mesquite, New Mexico*. 16 July.
- EA. 2012a. *Final Site Investigation Report, Doña Ana Dairies, Mesquite, New Mexico*. 9 February.
- EA. 2012b. *Final Site Investigation Report Addendum, Doña Ana Dairies, Mesquite, New Mexico*. 9 September.
- EA. 2013a. *Stage 2 Abatement Plan, Doña Ana Dairies, Mesquite, New Mexico*. 13 March.
- EA. 2013b. *Stage 2 Abatement Plan, Revision 01, Doña Ana Dairies, Mesquite, New Mexico*. 7 November.
- EA. 2016. *Stage 2 Implementation and Quarterly Groundwater Monitoring Report, Doña Ana Dairies, Mesquite, New Mexico*. 26 July.
- EA. 2018. *Annual Groundwater Monitoring Report, Doña Ana Dairies, Mesquite, New Mexico*. July.
- EA. 2019. *Stage 2 Abatement Plan Modification Proposal and DAD-06 Monitoring Well Rehabilitation for Doña Ana Dairies, Doña Ana County, New Mexico, Revision 02*. 26 July.
- EA. 2020a. *Five-Year Evaluation and Quarterly Groundwater Monitoring Report, Doña Ana Dairies, Mesquite, New Mexico*. 20 December.
- EA. 2020b. *S2AP Addendum for Reuse of Pumped Groundwater, Revision 01, Del Oro Dairy, Anthony, New Mexico*. 15 July.
- EA. 2021. *Stage 2 Abatement Plan Addendum for Reuse of Pumped Groundwater, Revision 02, Del Oro Dairy, Anthony, New Mexico*. July.
- EA. 2022. *Stage 2 Abatement Plan Modification Performance Plan for Doña Ana Dairies*. 15 February.
- EA. 2023. *Stage 2 Abatement Plan Modification Completion Report for Doña Ana Dairies (Del Oro Dairy), Anthony, New Mexico*. 16 May.
- Golder Associates, Inc. (Golder). 2006. *Stage 1 and 2 Abatement Plan Proposal, prepared for New Mexico Environment Department, Remediation Oversight Section, on behalf of Doña Ana Dairies*. 11 December.

- Golder. 2008a. *Existing Data Report and Conceptual Work Plan, Doña Ana Dairies, Mesquite, New Mexico*. 1 February.
- Golder. 2008b. Conceptual Work Plan. Doña Ana Dairies, Mesquite, New Mexico. February 1.
- Golder. 2008c. Notes for the Meeting Regarding New Monitoring Well Installation. Meeting Participants: Doña Ana Dairy representative, DAD technical representatives, and NMED staff. 28 July.
- Golder. 2008d. Sampling and Analysis Plan. Doña Ana Dairies, Mesquite, New Mexico. 11 August.
- New Mexico Environment Department (NMED). 2008. Approval of Sampling and Analysis Plan for the Doña Ana Dairies, Stage 1 Abatement Plan, Doña Ana County, New Mexico. 25 September.
- NMED. 2015. Approval of Stage 2 Abatement Plan Proposal for Doña Ana Dairies. Final Order from Mr. Ryan Flynn, Secretary, Ground Water Quality Bureau. 10 April.
- NMED. 2022. Stage 2 Abatement Plan Modification Approval for Dona Ana Dairies. 26 April.
- NMED, Doña Ana Dairies, and Rio Valle Concerned Citizens. 2015. Stipulated Agreement, Dona Ana Dairies Stage 2 Abatement Plan. 25 March.

TABLES

(Provided in Electronic Format via CD Located on Front Cover of Report)

**TABLE 1. SUMMARY OF MONITORING WELL FLUID GAUGING DATA
DONA ANA DAIRIES, DONA ANA COUNTY, NEW MEXICO**

Monitoring Well	Date Measured	Northing ^a	Easting ^a	Casing Elevation ^b	Depth to Water ^c	Ground Water Elevation ^b
NORTHERN AREA						
Northern Land Application Area						
70-03	1-May-2023	424580.78	1510233.88	3871.43	59.11	3812.32
	2-Feb-2023				59.25	3812.18
	1-Nov-2022				60.10	3811.33
	1-Aug-2022				60.07	3811.36
	2-May-2022				59.10	3812.33
	7-Feb-2022				58.25	3813.18
	1-Nov-2021				58.71	3812.72
	4-Aug-2021				58.18	3813.25
	3-May-2021				57.34	3814.09
	10-Feb-2021				56.98	3814.45
	2-Nov-2020				57.56	3813.87
	10-Aug-2020				58.02	3813.41
	11-May-2020				57.18	3814.25
	4-Feb-2020				56.95	3814.48
	8-Nov-2019				57.10	3814.33
	1-Aug-2019				58.39	3813.04
	8-May-2019				57.97	3813.46
	19-Feb-2019				56.90	3814.53
	12-Nov-2018				57.16	3814.27
	6-Aug-2018				58.05	3813.38
	17-May-2018				57.26	3814.17
	5-Feb-2018				56.16	3815.27
	6-Nov-2017				56.89	3814.54
	8-Aug-2017				57.90	3813.53
	15-May-2017				58.20	3813.23
	6-Feb-2017				57.09	3814.34
	7-Nov-2016				58.05	3813.38
	15-Aug-2016				58.74	3812.69
	16-May-2016				58.50	3812.93
	9-Feb-2016				57.37	3814.06
	6-Nov-2015				58.03	3813.40
	5-Aug-2015				58.45	3812.98
	6-May-2015				57.82	3813.61
	5-Feb-2015				56.55	3814.88
	5-Nov-2014				57.25	3814.18
	12-Aug-2014				57.24	3814.19
	12-May-2014				56.58	3814.85
	12-Feb-2014				55.26	3816.17
	6-Nov-2013				55.93	3815.50
	6-Aug-2013				54.52	3816.91
	7-May-2013				53.87	3817.56
7-Feb-2013	53.46	3817.97				
24-Oct-2012	54.05	3817.38				
30-Jul-2012	53.70	3817.73				
23-Apr-2012	52.84	3818.59				
30-Jan-2012	51.41	3820.02				
8-Dec-2011	51.49	3819.94				
19-Jul-2011	50.77	3820.66				
20-Apr-2011	49.69	3821.74				
17-Jan-2011	48.70	3822.73				
14-Sep-2010	49.02	3822.41				
24-Jun-2010	48.99	3822.44				
22-Mar-2010	48.90	3822.53				
8-Dec-2009	48.72	3822.71				
28-Aug-2009	49.21	3822.22				
26-May-2009	48.91	3822.52				
11-Dec-2008	48.02	3823.41				
28-Sep-2008	48.06	3823.37				
11-Jun-2008	49.20	3822.23				
5-Feb-2008	47.95	3823.48				
14-Nov-2007	48.10	3823.33				
12-Sep-2007	48.70	3822.73				

**TABLE 1. SUMMARY OF MONITORING WELL FLUID GAUGING DATA
DONA ANA DAIRIES, DONA ANA COUNTY, NEW MEXICO**

Monitoring Well	Date Measured	Northing ^a	Easting ^a	Casing Elevation ^b	Depth to Water ^c	Ground Water Elevation ^b
70/86/340-01	1-May-2023	427320.92	1508461.05	3866.77	54.00	3812.77
	2-Feb-2023				53.05	3813.72
	1-Nov-2022				53.74	3813.03
	1-Aug-2022				53.36	3813.41
	2-May-2022				52.69	3814.08
	7-Feb-2022				51.94	3814.83
	1-Nov-2021				52.33	3814.44
	4-Aug-2021				51.76	3815.01
	3-May-2021				51.18	3815.59
	10-Feb-2021				49.90	3816.87
	2-Nov-2020				51.00	3815.77
	10-Aug-2020				51.46	3815.31
	11-May-2020				51.15	3815.62
	4-Feb-2020				50.20	3816.57
	8-Nov-2019				50.44	3816.33
	1-Aug-2019				51.52	3815.25
	8-May-2019				51.31	3815.46
	19-Feb-2019				50.16	3816.61
	12-Nov-2018				50.26	3816.51
	6-Aug-2018				50.70	3816.07
	17-May-2018				50.25	3816.52
	5-Feb-2018				49.10	3817.67
	6-Nov-2017				49.58	3817.19
	8-Aug-2017				50.35	3816.42
	15-May-2017				51.40	3815.37
	6-Feb-2017				50.12	3816.65
	7-Nov-2016				51.02	3815.75
	15-Aug-2016				51.56	3815.21
	16-May-2016				51.48	3815.29
	9-Feb-2016				50.22	3816.55
	6-Nov-2015				51.02	3815.75
	5-Aug-2015				51.22	3815.55
	6-May-2015				50.90	3815.87
	5-Feb-2015				49.68	3817.09
	5-Nov-2014				50.67	3816.10
	12-Aug-2014				50.38	3816.39
	12-May-2014				49.94	3816.83
	12-Feb-2014				48.95	3817.82
	6-Nov-2013				49.21	3817.56
	6-Aug-2013				46.44	3820.33
	7-May-2013				46.79	3819.98
	7-Feb-2013				46.49	3820.28
	24-Oct-2012				47.30	3819.47
	30-Jul-2012				46.84	3819.93
	23-Apr-2012				45.91	3820.86
	8-Dec-2011				45.17	3821.60
	19-Jul-2011				44.49	3822.28
20-Apr-2011	43.15	3823.62				
17-Jan-2011	42.00	3824.77				
14-Sep-2010	41.79	3824.98				
24-Jun-2010	42.67	3824.10				
22-Mar-2010	42.21	3824.56				
8-Dec-2009	42.02	3824.75				
28-Aug-2009	42.39	3824.38				
26-May-2009	42.33	3824.44				
11-Dec-2008	41.15	3825.62				
28-Sep-2008	41.58	3825.19				
11-Jun-2008	42.31	3824.46				
5-Feb-2008	41.07	3825.70				
14-Nov-2007	41.38	3825.39				
12-Sep-2007	41.46	3825.31				

**TABLE 1. SUMMARY OF MONITORING WELL FLUID GAUGING DATA
DONA ANA DAIRIES, DONA ANA COUNTY, NEW MEXICO**

Monitoring Well	Date Measured	Northing ^a	Easting ^a	Casing Elevation ^b	Depth to Water ^c	Ground Water Elevation ^b
86/340-01	1-May-2023	432021.33	1503216.90	3876.14	60.31	3815.83
	2-Feb-2023				59.55	3816.59
	1-Nov-2022				60.05	3816.09
	1-Aug-2022				60.10	3816.04
	2-May-2022				59.20	3816.94
	7-Feb-2022				58.41	3817.73
	1-Nov-2021				58.78	3817.36
	4-Aug-2021				58.01	3818.13
	3-May-2021				57.21	3818.93
	10-Feb-2021				56.92	3819.22
	2-Nov-2020				57.08	3819.06
	10-Aug-2020				56.96	3819.18
	11-May-2020				57.00	3819.14
	4-Feb-2020				56.41	3819.73
	8-Nov-2019				56.83	3819.31
	1-Aug-2019				57.87	3818.27
	8-May-2019				57.95	3818.19
	19-Feb-2019				56.61	3819.53
	12-Nov-2018				57.17	3818.97
	6-Aug-2018				56.98	3819.16
	17-May-2018				57.00	3819.14
	5-Feb-2018				55.09	3821.05
	6-Nov-2017				55.91	3820.23
	8-Aug-2017				57.30	3818.84
	15-May-2017				58.13	3818.01
	6-Feb-2017				56.49	3819.65
	7-Nov-2016				57.58	3818.56
	15-Aug-2016				58.36	3817.78
	16-May-2016				58.48	3817.66
	9-Feb-2016				56.93	3819.21
	6-Nov-2015				57.83	3818.31
	5-Aug-2015				57.73	3818.41
	6-May-2015				57.74	3818.40
	5-Feb-2015				56.32	3819.82
	5-Nov-2014				57.31	3818.83
	12-Aug-2014				57.28	3818.86
	12-May-2014				57.04	3819.10
	12-Feb-2014				55.10	3821.04
	6-Nov-2013				55.78	3820.36
	6-Aug-2013				53.29	3822.85
	7-May-2013				52.65	3823.49
	7-Feb-2013				52.31	3823.83
	24-Oct-2012				53.16	3822.98
	30-Jul-2012				52.70	3823.44
	23-Apr-2012				52.20	3823.94
	30-Jan-2012				51.10	3825.04
	8-Dec-2011				51.20	3824.94
19-Jul-2011	50.36	3825.78				
20-Apr-2011	48.91	3827.23				
17-Jan-2011	47.00	3829.14				
14-Sep-2010	47.63	3828.51				
24-Jun-2010	48.22	3827.92				
22-Mar-2010	47.66	3828.48				
8-Dec-2009	47.39	3828.75				
28-Aug-2009	47.75	3828.39				
26-May-2009	47.86	3828.28				
11-Dec-2008	46.68	3829.46				
28-Sep-2008	47.44	3828.70				
11-Jun-2008	48.11	3828.03				
5-Feb-2008	46.68	3829.46				
14-Nov-2007	47.11	3829.03				
12-Sep-2007	47.85	3828.29				

**TABLE 1. SUMMARY OF MONITORING WELL FLUID GAUGING DATA
DONA ANA DAIRIES, DONA ANA COUNTY, NEW MEXICO**

Monitoring Well	Date Measured	Northing ^a	Easting ^a	Casing Elevation ^b	Depth to Water ^c	Ground Water Elevation ^b
Organ Dairy (Formerly known as Del Norte Dairy and Daybreak Dairy)						
126-04	24-May-2023	423258.23	1510546.24	3850.31	38.00	3812.31
	11-Jan-2023				37.62	3812.69
	8-Nov-2022				38.05	3812.26
	17-Aug-2022				38.00	3812.31
	5-May-2022				37.41	3812.90
	24-Feb-2022				36.20	3814.11
	9-Nov-2021				36.75	3813.56
	11-Aug-2021				36.60	3813.71
	4-May-2021				35.85	3814.46
	9-Feb-2021				34.95	3815.36
	10-Nov-2020				35.70	3814.61
	12-Aug-2020				36.13	3814.18
	11-May-2020				35.98	3814.33
	4-Feb-2020				35.35	3814.96
	8-Nov-2019				35.44	3814.87
	1-Aug-2019				36.75	3813.56
	8-May-2019				36.30	3814.01
	19-Feb-2019				35.32	3814.99
	12-Nov-2018				35.56	3814.75
	6-Aug-2018				36.34	3813.97
	17-May-2018				35.75	3814.56
	5-Feb-2018				34.67	3815.64
	6-Nov-2017				35.47	3814.84
	7-Aug-2017				36.60	3813.71
	15-May-2017				36.60	3813.71
	6-Feb-2017				35.61	3814.70
	7-Nov-2016				36.52	3813.79
	15-Aug-2016				37.28	3813.03
	16-May-2016				37.06	3813.25
	9-Feb-2016				38.20	3812.11
	5-Nov-2015				36.51	3813.80
	5-Aug-2015				37.00	3813.31
	6-May-2015				36.30	3814.01
	5-Feb-2015				35.06	3815.25
	5-Nov-2014				35.62	3814.69
	12-Aug-2014				35.61	3814.70
	12-May-2014				34.98	3815.33
	12-Feb-2014				33.79	3816.52
	6-Nov-2013				34.32	3815.99
	6-Aug-2013				32.93	3817.38
7-May-2013	32.01	3818.30				
7-Feb-2013	32.05	3818.26				
24-Oct-2012	32.58	3817.73				
30-Jul-2012	32.23	3818.08				
23-Apr-2012	31.46	3818.85				
26-Jan-2012	30.89	3819.42				
8-Dec-2011	30.84	3819.47				
19-Jul-2011	30.26	3820.05				
20-Apr-2011	29.09	3821.22				
17-Jan-2011	28.20	3822.11				
14-Sep-2010	28.60	3821.71				
24-Jun-2010	28.21	3822.10				
22-Mar-2010	28.33	3821.98				
8-Dec-2009	28.17	3822.14				
28-Aug-2009	28.50	3821.81				
26-May-2009	28.30	3822.01				
11-Dec-2008	27.56	3822.75				
27-Sep-2008	27.96	3822.35				
10-Jun-2008	28.61	3821.70				
6-Feb-2008	27.53	3822.78				
14-Nov-2007	27.61	3822.70				
11-Sep-2007	28.19	3822.12				

**TABLE 1. SUMMARY OF MONITORING WELL FLUID GAUGING DATA
DONA ANA DAIRIES, DONA ANA COUNTY, NEW MEXICO**

Monitoring Well	Date Measured	Northing ^a	Easting ^a	Casing Elevation ^b	Depth to Water ^c	Ground Water Elevation ^b
126-05	24-May-2023	422293.26	1510649.84	3842.62	30.70	3811.92
	11-Jan-2023				29.70	3812.92
	8-Nov-2022				30.05	3812.57
	17-Aug-2022				30.05	3812.57
	5-May-2022				28.20	3814.42
	24-Feb-2022				28.27	3814.35
	9-Nov-2021				28.00	3814.62
	11-Aug-2021				28.10	3814.52
	4-May-2021				27.40	3815.22
	9-Feb-2021				28.60	3814.02
	10-Nov-2020				26.85	3815.77
	12-Aug-2020				27.45	3815.17
	11-May-2020				29.35	3813.27
	4-Feb-2020				28.48	3814.14
	8-Nov-2019				27.71	3814.91
	1-Aug-2019				28.31	3814.31
	8-May-2019				28.04	3814.58
	19-Feb-2019				27.25	3815.37
	12-Nov-2018				27.08	3815.54
	6-Aug-2018				27.53	3815.09
	17-May-2018				27.53	3815.09
	5-Feb-2018				26.59	3816.03
	6-Nov-2017				27.15	3815.47
	7-Aug-2017				28.39	3814.23
	15-May-2017				28.59	3814.03
	6-Feb-2017				27.91	3814.71
	7-Nov-2016				28.45	3814.17
	15-Aug-2016				29.25	3813.37
	16-May-2016				29.48	3813.14
	9-Feb-2016				28.32	3814.30
	5-Nov-2015				28.80	3813.82
	5-Aug-2015				29.38	3813.24
	6-May-2015				28.87	3813.75
	5-Feb-2015				27.65	3814.97
	5-Nov-2014				27.95	3814.67
	12-Aug-2014				27.85	3814.77
	12-May-2014				27.63	3814.99
	12-Feb-2014				26.34	3816.28
	6-Nov-2013				26.67	3815.95
	6-Aug-2013				25.20	3817.42
	7-May-2013				24.65	3817.97
	7-Feb-2013				24.71	3817.91
	24-Oct-2012				24.96	3817.66
	30-Jul-2012				24.73	3817.89
	23-Apr-2012				24.21	3818.41
	26-Jan-2012				23.52	3819.10
	8-Dec-2011				23.50	3819.12
19-Jul-2011	22.72	3819.90				
20-Apr-2011	21.74	3820.88				
21-Jan-2011	21.30	3821.32				
14-Sep-2010	20.91	3821.71				
24-Jun-2010	21.13	3821.49				
22-Mar-2010	21.06	3821.56				
8-Dec-2009	20.88	3821.74				
28-Aug-2009	20.83	3821.79				
26-May-2009	20.91	3821.71				
11-Dec-2008	20.29	3822.33				
27-Sep-2008	20.42	3822.20				
10-Jun-2008	21.26	3821.36				
6-Feb-2008	20.34	3822.28				
14-Nov-2007	20.32	3822.30				
11-Sep-2007	20.74	3821.88				

**TABLE 1. SUMMARY OF MONITORING WELL FLUID GAUGING DATA
DONA ANA DAIRIES, DONA ANA COUNTY, NEW MEXICO**

Monitoring Well	Date Measured	Northing ^a	Easting ^a	Casing Elevation ^b	Depth to Water ^c	Ground Water Elevation ^b
126-07	24-May-2023	423613.62	1509986.47	3850.94	39.63	3811.31
	11-Jan-2023				38.20	3812.74
	8-Nov-2022				38.80	3812.14
	17-Aug-2022				38.92	3812.02
	5-May-2022				37.84	3813.10
	24-Feb-2022				36.54	3814.40
	9-Nov-2021				37.00	3813.94
	11-Aug-2021				36.55	3814.39
	4-May-2021				35.90	3815.04
	9-Feb-2021				35.10	3815.84
	10-Nov-2020				35.70	3815.24
	12-Aug-2020				36.09	3814.85
	11-May-2020				36.16	3814.78
	4-Feb-2020				35.55	3815.39
	8-Nov-2019				35.66	3815.28
	1-Aug-2019				36.76	3814.18
	8-May-2019				36.40	3814.54
	19-Feb-2019				35.50	3815.44
	12-Nov-2018				35.67	3815.27
	6-Aug-2018				36.38	3814.56
	17-May-2018				35.74	3815.20
	5-Feb-2018				34.80	3816.14
	6-Nov-2017				35.45	3815.49
	7-Aug-2017				36.76	3814.18
	15-May-2017				36.85	3814.09
	6-Feb-2017				35.95	3814.99
	7-Nov-2016				36.79	3814.15
	15-Aug-2016				37.54	3813.40
	16-May-2016				37.36	3813.58
	9-Feb-2016				36.33	3814.61
	5-Nov-2015				36.94	3814.00
	5-Aug-2015				37.39	3813.55
	6-May-2015				36.68	3814.26
	5-Feb-2015				35.62	3815.32
	5-Nov-2014				36.34	3814.60
	12-Aug-2014				36.22	3814.72
	12-May-2014				35.52	3815.42
	12-Feb-2014				34.38	3816.56
	6-Nov-2013				34.89	3816.05
	6-Aug-2013				32.46	3818.48
7-May-2013	32.33	3818.61				
7-Feb-2013	32.58	3818.36				
24-Oct-2012	32.97	3817.97				
30-Jul-2012	32.60	3818.34				
23-Apr-2012	31.84	3819.10				
26-Jan-2012	31.23	3819.71				
8-Dec-2011	31.28	3819.66				
19-Jul-2011	30.30	3820.64				
20-Apr-2011	28.59	3822.35				
27-Jan-2011	28.43	3822.51				
14-Sep-2010	28.45	3822.49				
24-Jun-2010	28.74	3822.20				
22-Mar-2010	28.57	3822.37				
8-Dec-2009	28.37	3822.57				
28-Aug-2009	28.61	3822.33				
26-May-2009	28.47	3822.47				
11-Dec-2008	27.70	3823.24				
27-Sep-2008	27.97	3822.97				
10-Jun-2008	28.78	3822.16				
6-Feb-2008	27.71	3823.23				
14-Nov-2007	27.63	3823.31				
11-Sep-2007	28.06	3822.88				

**TABLE 1. SUMMARY OF MONITORING WELL FLUID GAUGING DATA
DONA ANA DAIRIES, DONA ANA COUNTY, NEW MEXICO**

Monitoring Well	Date Measured	Northing ^a	Easting ^a	Casing Elevation ^b	Depth to Water ^c	Ground Water Elevation ^b
126-09	24-May-2023	425154.15	1510994.31	3893.35	82.25	3811.10
	11-Jan-2023				80.70	3812.65
	8-Nov-2022				81.50	3811.85
	17-Aug-2022				82.20	3811.15
	5-May-2022				80.91	3812.44
	24-Feb-2022				79.55	3813.80
	9-Nov-2021				80.40	3812.95
	11-Aug-2021				80.60	3812.75
	4-May-2021				79.50	3813.85
	9-Feb-2021				78.50	3814.85
	10-Nov-2020				79.50	3813.85
	12-Aug-2020				80.00	3813.35
	11-May-2020				80.31	3813.04
	4-Feb-2020				79.67	3813.68
	8-Nov-2019				79.08	3814.27
	1-Aug-2019				80.45	3812.90
	8-May-2019				79.95	3813.40
	19-Feb-2019				78.70	3814.65
	12-Nov-2018				79.00	3814.35
	6-Aug-2018				80.10	3813.25
	17-May-2018				79.28	3814.07
	5-Feb-2018				77.87	3815.48
	6-Nov-2017				78.83	3814.52
	7-Aug-2017				79.61	3813.74
	15-May-2017				79.78	3813.57
	6-Feb-2017				77.00	3816.35
	7-Nov-2016				79.62	3813.73
	15-Aug-2016				80.33	3813.02
	16-May-2016				80.00	3813.35
	9-Feb-2016				78.58	3814.77
	5-Nov-2015				79.27	3814.08
	5-Aug-2015				79.72	3813.63
	6-May-2015				79.01	3814.34
	5-Feb-2015				77.53	3815.82
	5-Nov-2014				78.21	3815.14
	12-Aug-2014				78.15	3815.20
	12-May-2014				77.70	3815.65
	12-Feb-2014				76.14	3817.21
	6-Nov-2013				76.91	3816.44
	6-Aug-2013				76.09	3817.26
	7-May-2013				75.40	3817.95
	7-Feb-2013				74.61	3818.74
24-Oct-2012	75.29	3818.06				
30-Jul-2012	74.98	3818.37				
23-Apr-2012	73.98	3819.37				
26-Jan-2012	72.24	3821.11				
8-Dec-2011	73.34	3820.01				
19-Jul-2011	73.19	3820.16				
20-Apr-2011	72.11	3821.24				
21-Jan-2011	71.00	3822.35				
14-Sep-2010	71.52	3821.83				
29-Jun-2010	72.23	3821.12				
22-Mar-2010	71.03	3822.32				
8-Dec-2009	70.94	3822.41				
28-Aug-2009	71.73	3821.62				
26-May-2009	71.12	3822.23				
11-Dec-2008	70.27	3823.08				
27-Sep-2008	70.79	3822.56				
10-Jun-2008	71.47	3821.88				
6-Feb-2008	70.08	3823.27				
14-Nov-2007	70.46	3822.89				
11-Sep-2007	71.39	3821.96				

**TABLE 1. SUMMARY OF MONITORING WELL FLUID GAUGING DATA
DONA ANA DAIRIES, DONA ANA COUNTY, NEW MEXICO**

Monitoring Well	Date Measured	Northing ^a	Easting ^a	Casing Elevation ^b	Depth to Water ^c	Ground Water Elevation ^b
126-12	24-May-2023	421492.11	1510198.45	3838.88	26.45	3812.43
	11-Jan-2023				25.35	3813.53
	8-Nov-2022				25.30	3813.58
	17-Aug-2022				24.45	3814.43
	5-May-2022				24.26	3814.62
	24-Feb-2022				23.55	3815.33
	9-Nov-2021				22.86	3816.02
	11-Aug-2021				22.60	3816.28
	4-May-2021				22.15	3816.73
	9-Feb-2021				22.00	3816.88
	10-Nov-2020				21.50	3817.38
	12-Aug-2020				21.61	3817.27
	11-May-2020				22.70	3816.18
	4-Feb-2020				22.50	3816.38
	8-Nov-2019				21.69	3817.19
	1-Aug-2019				22.84	3816.04
	8-May-2019				22.70	3816.18
	19-Feb-2019				22.50	3816.38
	12-Nov-2018				21.94	3816.94
	6-Aug-2018				21.56	3817.32
	17-May-2018				Covered in dirt	
	5-Feb-2018				21.85	3817.03
	6-Nov-2017				21.90	3816.98
	7-Aug-2017				23.26	3815.62
	15-May-2017				23.65	3815.23
	6-Feb-2017				23.62	3815.26
	7-Nov-2016				23.59	3815.29
	15-Aug-2016				24.52	3814.36
	16-May-2016				24.84	3814.04
	9-Feb-2016				24.41	3814.47
	5-Nov-2015				24.05	3814.83
	5-Aug-2015				25.02	3813.86
	6-May-2015				24.78	3814.10
	5-Feb-2015				23.86	3815.02
	5-Nov-2014				23.65	3815.23
	14-Aug-2014				23.37	3815.51
	12-May-2014				23.60	3815.28
	12-Feb-2014				22.46	3816.42
	6-Nov-2013				22.39	3816.49
	6-Aug-2013				21.44	3817.44
	7-May-2013				21.05	3817.83
7-Feb-2013	20.92	3817.96				
24-Oct-2012	20.53	3818.35				
30-Jul-2012	20.48	3818.40				
23-Apr-2012	20.22	3818.66				
30-Jan-2012	19.79	3819.09				
8-Dec-2011	19.55	3819.33				
19-Jul-2011	18.27	3820.61				
20-Apr-2011	17.62	3821.26				
17-Jan-2011	17.00	3821.88				
16-Sep-2010	16.48	3822.40				
24-Jun-2010	17.30	3821.58				
24-Jun-2010	17.30	3821.58				
22-Mar-2010	17.19	3821.69				
8-Dec-2009	16.99	3821.89				
28-Aug-2009	16.49	3822.39				
26-May-2009	16.85	3822.03				
11-Dec-2008	16.37	3822.51				
27-Sep-2008	16.29	3822.59				
10-Jun-2008	17.19	3821.69				
6-Feb-2008	16.62	3822.26				
14-Nov-2007	16.33	3822.55				
11-Sep-2007	16.56	3822.32				

**TABLE 1. SUMMARY OF MONITORING WELL FLUID GAUGING DATA
DONA ANA DAIRIES, DONA ANA COUNTY, NEW MEXICO**

Monitoring Well	Date Measured	Northing ^a	Easting ^a	Casing Elevation ^b	Depth to Water ^c	Ground Water Elevation ^b
126-13	24-May-2023	423431.96	1510657.41	3857.37	46.50	3810.87
	11-Jan-2023				44.75	3812.62
	8-Nov-2022				45.40	3811.97
	17-Aug-2022				45.65	3811.72
	5-May-2022				44.54	3812.83
	24-Feb-2022				43.30	3814.07
	9-Nov-2021				43.90	3813.47
	11-Aug-2021				43.80	3813.57
	4-May-2021				43.05	3814.32
	9-Feb-2021				42.10	3815.27
	10-Nov-2020				42.80	3814.57
	12-Aug-2020				43.31	3814.06
	11-May-2020				43.03	3814.34
	4-Feb-2020				42.42	3814.95
	8-Nov-2019				42.75	3814.62
	1-Aug-2019				43.91	3813.46
	8-May-2019				43.48	3813.89
	19-Feb-2019				42.45	3814.92
	12-Nov-2018				42.70	3814.67
	6-Aug-2018				43.52	3813.85
	17-May-2018				42.90	3814.47
	5-Feb-2018				41.78	3815.59
	6-Nov-2017				42.61	3814.76
	7-Aug-2017				43.70	3813.67
	15-May-2017				43.74	3813.63
	6-Feb-2017				42.64	3814.73
	7-Nov-2016				43.60	3813.77
	15-Aug-2016				44.35	3813.02
	16-May-2016				44.13	3813.24
	9-Feb-2016				42.93	3814.44
	5-Nov-2015				43.55	3813.82
	5-Aug-2015				44.00	3813.37
	6-May-2015				43.34	3814.03
	5-Feb-2015				42.05	3815.32
	5-Nov-2014				42.63	3814.74
	12-Aug-2014				42.60	3814.77
	12-May-2014				42.04	3815.33
	12-Feb-2014				40.78	3816.59
	6-Nov-2013				41.35	3816.02
	6-Aug-2013				39.96	3817.41
7-May-2013	39.01	3818.36				
7-Feb-2013	39.07	3818.30				
24-Oct-2012	39.60	3817.77				
30-Jul-2012	39.30	3818.07				
23-Apr-2012	38.52	3818.85				
26-Jan-2012	37.80	3819.57				
8-Dec-2011	37.86	3819.51				
19-Jul-2011	37.29	3820.08				
20-Apr-2011	35.23	3822.14				
13-Jan-2011	35.23	3822.14				
14-Sep-2010	35.66	3821.71				
24-Jun-2010	36.01	3821.36				
22-Mar-2010	35.40	3821.97				
8-Dec-2009	35.24	3822.13				
28-Aug-2009	35.60	3821.77				
26-May-2009	35.37	3822.00				
11-Dec-2008	34.62	3822.75				
27-Sep-2008	34.99	3822.38				
10-Jun-2008	35.69	3821.68				
6-Feb-2008	NA	NA				
14-Nov-2007	16.33	3841.04				
11-Sep-2007	NA	NA				

**TABLE 1. SUMMARY OF MONITORING WELL FLUID GAUGING DATA
DONA ANA DAIRIES, DONA ANA COUNTY, NEW MEXICO**

Monitoring Well	Date Measured	Northing ^a	Easting ^a	Casing Elevation ^b	Depth to Water ^c	Ground Water Elevation ^b
Mountain View Dairy						
70-01	1-May-2023	423303.43	1510585.63	3851.84	40.06	3811.78
	2-Feb-2023				39.15	3812.69
	1-Nov-2022				39.80	3812.04
	1-Aug-2022				39.42	3812.42
	2-May-2022				38.55	3813.29
	7-Feb-2022				37.80	3814.04
	1-Nov-2021				38.21	3813.63
	4-Aug-2021				37.95	3813.89
	3-May-2021				37.50	3814.34
	10-Feb-2021				36.89	3814.95
	2-Nov-2020				37.35	3814.49
	10-Aug-2020				37.85	3813.99
	11-May-2020				37.29	3814.55
	4-Feb-2020				36.92	3814.92
	8-Nov-2019				37.41	3814.43
	1-Aug-2019				38.34	3813.50
	8-May-2019				37.90	3813.94
	19-Feb-2019				36.90	3814.94
	12-Nov-2018				37.15	3814.69
	6-Aug-2018				37.95	3813.89
	17-May-2018				37.34	3814.50
	5-Feb-2018				36.25	3815.59
	6-Nov-2017				37.05	3814.79
	8-Aug-2017				38.17	3813.67
	15-May-2017				38.22	3813.62
	6-Feb-2017				37.16	3814.68
	22-Nov-2016				37.93	3813.91
	15-Aug-2016				38.85	3812.99
	16-May-2016				38.62	3813.22
	9-Feb-2016				37.43	3814.41
	6-Nov-2015				38.07	3813.77
	5-Aug-2015				38.59	3813.25
	6-May-2015				37.85	3813.99
	5-Feb-2015				36.61	3815.23
	5-Nov-2014				37.17	3814.67
	12-Aug-2014				37.18	3814.66
	12-May-2014				36.56	3815.28
	12-Feb-2014				35.33	3816.51
	6-Nov-2013				35.67	3816.17
	6-Aug-2013				34.19	3817.65
7-May-2013	34.06	3817.78				
7-Feb-2013	33.58	3818.26				
24-Oct-2012	34.08	3817.76				
30-Jul-2012	33.80	3818.04				
23-Apr-2012	33.09	3818.75				
26-Jan-2012	32.29	3819.55				
8-Dec-2011	32.40	3819.44				
9-Jul-2011	31.77	3820.07				
20-Apr-2011	30.69	3821.15				
17-Jan-2011	29.72	3822.12				
14-Sep-2010	30.19	3821.65				
24-Jun-2010	29.30	3822.54				
22-Mar-2010	Unable to open well					
8-Dec-2009	29.75	3822.09				
28-Aug-2009	30.08	3821.76				
26-May-2009	29.88	3821.96				
11-Dec-2008	29.13	3822.71				
27-Sep-2008	29.79	3822.05				
10-Jun-2008	30.20	3821.64				
5-Feb-2008	29.10	3822.74				
13-Nov-2007	29.25	3822.59				
12-Sep-2007	29.77	3822.07				

**TABLE 1. SUMMARY OF MONITORING WELL FLUID GAUGING DATA
DONA ANA DAIRIES, DONA ANA COUNTY, NEW MEXICO**

Monitoring Well	Date Measured	Northing ^a	Easting ^a	Casing Elevation ^b	Depth to Water ^c	Ground Water Elevation ^b
70-02	1-May-2023	423412.73	1511192.51	3861.25	47.65	3813.60
	2-Feb-2023				48.62	3812.63
	1-Nov-2022				49.35	3811.90
	1-Aug-2022				49.11	3812.14
	2-May-2022				48.65	3812.60
	7-Feb-2022				47.83	3813.42
	1-Nov-2021				48.08	3813.17
	4-Aug-2021				47.76	3813.49
	3-May-2021				47.11	3814.14
	10-Feb-2021				46.79	3814.46
	2-Nov-2020				47.20	3814.05
	10-Aug-2020				47.67	3813.58
	11-May-2020				47.26	3813.99
	4-Feb-2020				46.60	3814.65
	8-Nov-2019				47.13	3814.12
	1-Aug-2019				48.17	3813.08
	8-May-2019				47.70	3813.55
	19-Feb-2019				46.64	3814.61
	12-Nov-2018				46.90	3814.35
	6-Aug-2018				47.78	3813.47
	17-May-2018				47.19	3814.06
	5-Feb-2018				45.97	3815.28
	6-Nov-2017				46.85	3814.40
	8-Aug-2017				47.85	3813.40
	15-May-2017				47.93	3813.32
	6-Feb-2017				46.70	3814.55
	7-Nov-2016				47.74	3813.51
	15-Aug-2016				48.46	3812.79
	16-May-2016				48.26	3812.99
	9-Feb-2016				46.96	3814.29
	6-Nov-2015				47.58	3813.67
	5-Aug-2015				48.06	3813.19
	6-May-2015				47.40	3813.85
	5-Feb-2015				46.00	3815.25
	5-Nov-2014				46.67	3814.58
	13-Aug-2014				46.73	3814.52
	12-May-2014				46.08	3815.17
	12-Feb-2014				44.75	3816.50
	6-Nov-2013				45.31	3815.94
	6-Aug-2013				43.87	3817.38
7-May-2013	43.16	3818.09				
7-Feb-2013	43.13	3818.12				
24-Oct-2012	43.66	3817.59				
30-Jul-2012	43.33	3817.92				
23-Apr-2012	42.60	3818.65				
26-Jan-2012	41.81	3819.44				
8-Dec-2011	41.89	3819.36				
19-Jul-2011	41.52	3819.73				
20-Apr-2011	40.46	3820.79				
17-Jan-2011	38.90	3822.35				
14-Sep-2010	39.96	3821.29				
24-Jun-2010	39.01	3822.24				
22-Mar-2010	39.54	3821.71				
8-Dec-2009	39.42	3821.83				
28-Aug-2009	39.81	3821.44				
26-May-2009	39.56	3821.69				
11-Dec-2008	38.84	3822.41				
27-Sep-2008	39.20	3822.05				
10-Jun-2008	39.90	3821.35				
6-Feb-2008	39.77	3821.48				
14-Nov-2007	39.01	3822.24				
11-Sep-2007	39.60	3821.65				

**TABLE 1. SUMMARY OF MONITORING WELL FLUID GAUGING DATA
DONA ANA DAIRIES, DONA ANA COUNTY, NEW MEXICO**

Monitoring Well	Date Measured	Northing ^a	Easting ^a	Casing Elevation ^b	Depth to Water ^c	Ground Water Elevation ^b
70-04	1-May-2023	422798.94	1510922.20	3849.81	38.02	3811.79
	2-Feb-2023				37.10	3812.71
	1-Nov-2022				37.50	3812.31
	1-Aug-2022				37.61	3812.20
	2-May-2022				36.78	3813.03
	7-Feb-2022				35.90	3813.91
	1-Nov-2021				36.11	3813.70
	4-Aug-2021				35.89	3813.92
	3-May-2021				35.41	3814.40
	10-Feb-2021				34.66	3815.15
	2-Nov-2020				35.15	3814.66
	10-Aug-2020				35.75	3814.06
	11-May-2020				35.71	3814.10
	4-Feb-2020				34.95	3814.86
	8-Nov-2019				35.03	3814.78
	1-Aug-2019				36.35	3813.46
	8-May-2019				35.47	3814.34
	19-Feb-2019				35.00	3814.81
	12-Nov-2018				35.09	3814.72
	6-Aug-2018				35.90	3813.91
	17-May-2018				35.55	3814.26
	5-Feb-2018				34.36	3815.45
	6-Nov-2017				35.11	3814.70
	8-Aug-2017				36.22	3813.59
	15-May-2017				36.36	3813.45
	6-Feb-2017				35.31	3814.50
	7-Nov-2016				36.15	3813.66
	15-Aug-2016				36.92	3812.89
	16-May-2016				36.90	3812.91
	9-Feb-2016				35.63	3814.18
	6-Nov-2015				36.17	3813.64
	5-Aug-2015				36.74	3813.07
	6-May-2015				36.13	3813.68
	5-Feb-2015				34.78	3815.03
	5-Nov-2014				35.20	3814.61
	13-Aug-2014				35.31	3814.50
12-May-2014	34.81	3815.00				
12-Feb-2014	33.52	3816.29				
7-Nov-2013	34.05	3815.76				
6-Aug-2013	32.03	3817.78				
7-May-2013	31.80	3818.01				
7-Feb-2013	31.85	3817.96				

**TABLE 1. SUMMARY OF MONITORING WELL FLUID GAUGING DATA
DONA ANA DAIRIES, DONA ANA COUNTY, NEW MEXICO**

Monitoring Well	Date Measured	Northing ^a	Easting ^a	Casing Elevation ^b	Depth to Water ^c	Ground Water Elevation ^b
Buena Vista Diary I						
86-01	1-May-2023	421534.62	1511667.76	3864.96	52.55	3812.41
	2-Feb-2023				52.22	3812.74
	1-Nov-2022				52.40	3812.56
	1-Aug-2022				52.30	3812.66
	2-May-2022				51.78	3813.18
	7-Feb-2022				50.92	3814.04
	1-Nov-2021				50.89	3814.07
	4-Aug-2021				50.66	3814.30
	3-May-2021				50.40	3814.56
	10-Feb-2021				50.02	3814.94
	2-Nov-2020				50.29	3814.67
	10-Aug-2020				51.10	3813.86
	11-May-2020				51.43	3813.53
	4-Feb-2020				50.07	3814.89
	8-Nov-2019				50.00	3814.96
	1-Aug-2019				51.19	3813.77
	8-May-2019				50.91	3814.05
	19-Feb-2019				50.15	3814.81
	12-Nov-2018				50.04	3814.92
	6-Aug-2018				50.62	3814.34
	17-May-2018				50.71	3814.25
	5-Feb-2018				49.60	3815.36
	6-Nov-2017				50.25	3814.71
	7-Aug-2017				51.12	3813.84
	15-May-2017				51.43	3813.53
	6-Feb-2017				50.60	3814.36
	7-Nov-2016				51.26	3813.70
	15-Aug-2016				51.89	3813.07
	16-May-2016				52.08	3812.88
	9-Feb-2016				51.00	3813.96
	5-Nov-2015				51.43	3813.53
	5-Aug-2015				51.83	3813.13
	6-May-2015				51.44	3813.52
	5-Feb-2015				50.13	3814.83
	5-Nov-2014				50.40	3814.56
	13-Aug-2014				50.29	3814.67
	12-May-2014				50.20	3814.76
	17-Feb-2014				48.87	3816.09
	6-Nov-2013				42.33	3822.63
	6-Aug-2013				47.43	3817.53
7-May-2013	47.21	3817.75				
7-Feb-2013	47.35	3817.61				
24-Oct-2012	47.61	3817.35				
30-Jul-2012	47.26	3817.70				
23-Apr-2012	46.86	3818.10				
30-Jan-2012	46.34	3818.62				
8-Dec-2011	46.22	3818.74				
19-Jul-2011	45.66	3819.30				
20-Apr-2011	44.28	3820.68				
17-Jan-2011	44.30	3820.66				
16-Sep-2010	44.09	3820.87				
24-Jun-2010	44.39	3820.57				
22-Mar-2010	44.19	3820.77				
8-Dec-2009	43.89	3821.07				
28-Aug-2009	43.96	3821.00				
26-May-2009	44.03	3820.93				
11-Dec-2008	43.53	3821.43				
28-Sep-2008	43.60	3821.36				
10-Jun-2008	44.44	3820.52				
5-Feb-2008	43.69	3821.27				
13-Nov-2007	43.78	3821.18				
12-Sep-2007	44.21	3820.75				

**TABLE 1. SUMMARY OF MONITORING WELL FLUID GAUGING DATA
DONA ANA DAIRIES, DONA ANA COUNTY, NEW MEXICO**

Monitoring Well	Date Measured	Northing ^a	Easting ^a	Casing Elevation ^b	Depth to Water ^c	Ground Water Elevation ^b
86-02	1-May-2023	421792.08	1510881.53	3848.08	34.63	3813.45
	2-Feb-2023				34.80	3813.28
	1-Nov-2022				34.45	3813.63
	1-Aug-2022				34.38	3813.70
	2-May-2022				34.00	3814.08
	7-Feb-2022				33.08	3815.00
	1-Nov-2021				32.84	3815.24
	4-Aug-2021				32.59	3815.49
	3-May-2021				32.31	3815.77
	10-Feb-2021				32.09	3815.99
	2-Nov-2020				32.11	3815.97
	10-Aug-2020				32.21	3815.87
	11-May-2020				32.90	3815.18
	4-Feb-2020				32.20	3815.88
	8-Nov-2019				32.89	3815.19
	1-Aug-2019				33.00	3815.08
	8-May-2019				32.81	3815.27
	19-Feb-2019				32.27	3815.81
	12-Nov-2018				31.95	3816.13
	6-Aug-2018				32.15	3815.93
	17-May-2018				32.49	3815.59
	5-Feb-2018				31.66	3816.42
	6-Nov-2017				32.05	3816.03
	7-Aug-2017				33.08	3815.00
	15-May-2017				33.50	3814.58
	6-Feb-2017				33.09	3814.99
	7-Nov-2016				33.40	3814.68
	15-Aug-2016				34.15	3813.93
	16-May-2016				34.45	3813.63
	9-Feb-2016				33.64	3814.44
	5-Nov-2015				33.87	3814.21
	5-Aug-2015				34.35	3813.73
	6-May-2015				33.97	3814.11
	5-Feb-2015				32.88	3815.20
	5-Nov-2014				33.01	3815.07
	12-Aug-2014				32.62	3815.46
	12-May-2014				32.70	3815.38
	12-Feb-2014				31.62	3816.46
	6-Nov-2013				31.68	3816.40
	6-Aug-2013				30.37	3817.71
7-May-2013	30.13	3817.95				
7-Feb-2013	30.07	3818.01				
24-Oct-2012	29.71	3818.37				
30-Jul-2012	29.71	3818.37				
23-Apr-2012	29.43	3818.65				
30-Jan-2012	28.94	3819.14				
8-Dec-2011	28.77	3819.31				
19-Jul-2011	27.74	3820.34				
20-Apr-2011	27.18	3820.90				
17-Jan-2011	26.34	3821.74				
16-Sep-2010	26.18	3821.90				
24-Jun-2010	26.79	3821.29				
22-Mar-2010	26.54	3821.54				
8-Dec-2009	26.33	3821.75				
28-Aug-2009	26.11	3821.97				
26-May-2009	26.29	3821.79				
11-Dec-2008	25.77	3822.31				
28-Sep-2008	25.78	3822.3				
10-Jun-2008	26.65	3821.43				
5-Feb-2008	26.95	3821.13				
13-Nov-2007	25.88	3822.2				
12-Sep-2007	26.19	3821.89				

**TABLE 1. SUMMARY OF MONITORING WELL FLUID GAUGING DATA
DONA ANA DAIRIES, DONA ANA COUNTY, NEW MEXICO**

Monitoring Well	Date Measured	Northing ^a	Easting ^a	Casing Elevation ^b	Depth to Water ^c	Ground Water Elevation ^b
Bright Star Dairy						
340-01	1-May-2023	421410.13	1511423.42	3858.48	46.30	3812.18
	2-Feb-2023				45.50	3812.98
	1-Nov-2022				45.46	3813.02
	1-Aug-2022				45.16	3813.32
	2-May-2022				44.84	3813.64
	7-Feb-2022				44.02	3814.46
	1-Nov-2021				43.80	3814.68
	4-Aug-2021				43.56	3814.92
	3-May-2021				43.26	3815.22
	10-Feb-2021				42.78	3815.70
	2-Nov-2020				43.01	3815.47
	10-Aug-2020				43.31	3815.17
	11-May-2020				43.89	3814.59
	4-Feb-2020				43.12	3815.36
	8-Nov-2019				43.03	3815.45
	1-Aug-2019				44.00	3814.48
	8-May-2019				43.77	3814.71
	19-Feb-2019				43.18	3815.30
	12-Nov-2018				42.93	3815.55
	6-Aug-2018				43.18	3815.30
	17-May-2018				43.66	3814.82
	5-Feb-2018				42.66	3815.82
	6-Nov-2017				43.15	3815.33
	8-Aug-2017				44.00	3814.48
	15-May-2017				44.49	3813.99
	6-Feb-2017				43.92	3814.56
	7-Nov-2016				44.31	3814.17
	15-Aug-2016				44.97	3813.51
	16-May-2016				45.23	3813.25
	9-Feb-2016				44.37	3814.11
	6-Nov-2015				44.60	3813.88
	5-Aug-2015				45.01	3813.47
	6-May-2015				44.62	3813.86
	5-Feb-2015				43.56	3814.92
	5-Nov-2014				43.66	3814.82
	12-Aug-2014				43.32	3815.16
	12-May-2014				43.49	3814.99
	12-Feb-2014				42.30	3816.18
	6-Nov-2013				42.33	3816.15
	6-Aug-2013				41.21	3817.27
7-May-2013	40.80	3817.68				
7-Feb-2013	40.75	3817.73				
24-Oct-2012	40.82	3817.66				
30-Jul-2012	40.44	3818.04				
23-Apr-2012	40.16	3818.32				
25-Jan-2012	39.70	3818.78				
8-Dec-2011	39.54	3818.94				
19-Jul-2011	38.74	3819.74				
20-Apr-2011	38.14	3820.34				
17-Jan-2011	37.33	3821.15				
14-Sep-2010	37.20	3821.28				
24-Jun-2010	38.05	3820.43				
22-Mar-2010	37.48	3821.00				
8-Dec-2009	37.26	3821.22				
28-Aug-2009	37.10	3821.38				
26-May-2009	37.26	3821.22				
11-Dec-2008	36.79	3821.69				
27-Sep-2008	36.77	3821.71				
10-Jun-2008	37.63	3820.85				
6-Feb-2008	37.03	3821.45				
14-Nov-2007	37.00	3821.48				
11-Sep-2007	37.36	3821.12				

**TABLE 1. SUMMARY OF MONITORING WELL FLUID GAUGING DATA
DONA ANA DAIRIES, DONA ANA COUNTY, NEW MEXICO**

Monitoring Well	Date Measured	Northing ^a	Easting ^a	Casing Elevation ^b	Depth to Water ^c	Ground Water Elevation ^b
340-02	1-May-2023	420641.08	1512051.57	3869.76	Dry	
	2-Feb-2023				56.71	3813.05
	1-Nov-2022				56.69	3813.07
	1-Aug-2022				56.19	3813.57
	2-May-2022				56.11	3813.65
	7-Feb-2022				55.56	3814.20
	1-Nov-2021				55.08	3814.68
	4-Aug-2021				54.85	3814.91
	3-May-2021				54.77	3814.99
	10-Feb-2021				54.21	3815.55
	2-Nov-2020				54.36	3815.40
	10-Aug-2020				54.75	3815.01
	11-May-2020				55.31	3814.45
	4-Feb-2020				54.70	3815.06
	8-Nov-2019				54.40	3815.36
	1-Aug-2019				55.39	3814.37
	8-May-2019				55.20	3814.56
	19-Feb-2019				54.67	3815.09
	12-Nov-2018				54.45	3815.31
	6-Aug-2018				54.46	3815.30
	17-May-2018				55.35	3814.41
	5-Feb-2018				54.27	3815.49
	6-Nov-2017				54.74	3815.02
	8-Aug-2017				55.60	3814.16
	15-May-2017				56.00	3813.76
	6-Feb-2017				55.43	3814.33
	7-Nov-2016				55.78	3813.98
	15-Aug-2016				56.52	3813.24
	16-May-2016				56.40	3813.36
	9-Feb-2016				55.84	3813.92
	6-Nov-2015				56.01	3813.75
	5-Aug-2015				56.46	3813.30
	6-May-2015				56.10	3813.66
	5-Feb-2015				55.00	3814.76
	5-Nov-2014				55.05	3814.71
	12-Aug-2014				54.65	3815.11
	12-May-2014				54.80	3814.96
	12-Feb-2014				53.80	3815.96
	6-Nov-2013				53.59	3816.17
	6-Aug-2013				52.92	3816.84
7-May-2013	52.34	3817.42				
7-Feb-2013	52.29	3817.47				
24-Oct-2012	52.26	3817.50				
30-Jul-2012	51.67	3818.09				
23-Apr-2012	51.61	3818.15				
25-Jan-2012	51.31	3818.45				
8-Dec-2011	51.07	3818.69				
19-Jul-2011	50.24	3819.52				
20-Apr-2011	48.86	3820.90				
17-Jan-2011	49.00	3820.76				
14-Sep-2010	48.80	3820.96				
24-Jun-2010	49.67	3820.09				
22-Mar-2010	49.17	3820.59				
8-Dec-2009	49.03	3820.73				
28-Aug-2009	48.79	3820.97				
26-May-2009	48.94	3820.82				
11-Dec-2008	48.62	3821.14				
28-Sep-2008	48.48	3821.28				
10-Jun-2008	49.30	3820.46				
5-Feb-2008	48.90	3820.86				
14-Nov-2007	48.84	3820.92				
12-Sep-2007	49.28	3820.48				

**TABLE 1. SUMMARY OF MONITORING WELL FLUID GAUGING DATA
DONA ANA DAIRIES, DONA ANA COUNTY, NEW MEXICO**

Monitoring Well	Date Measured	Northing ^a	Easting ^a	Casing Elevation ^b	Depth to Water ^c	Ground Water Elevation ^b
Former D&J Dairy (Dominguez 2)						
42-02	2-May-2023	419982.45	1511126.19	3844.69	31.00	3813.69
	3-Feb-2023				30.01	3814.68
	2-Nov-2022				29.10	3815.59
	2-Aug-2022				28.18	3816.51
	2-May-2022				28.99	3815.70
	7-Feb-2022				28.09	3816.60
	1-Nov-2021				27.15	3817.54
	4-Aug-2021				26.90	3817.79
	3-May-2021				27.09	3817.60
	10-Feb-2021				26.82	3817.87
	2-Nov-2020				26.03	3818.66
	10-Aug-2020				27.90	3816.79
	11-May-2020				28.29	3816.40
	4-Feb-2020				27.68	3817.01
	8-Nov-2019				24.83	3819.86
	5-Aug-2019				26.81	3817.88
	8-May-2019				27.50	3817.19
	19-Feb-2019				27.30	3817.39
	13-Nov-2018				27.08	3817.61
	6-Aug-2018				25.50	3819.19
	17-May-2018				27.76	3816.93
	6-Feb-2018				27.10	3817.59
	7-Nov-2017				27.20	3817.49
	8-Aug-2017				27.34	3817.35
	15-May-2017				28.75	3815.94
	6-Feb-2017				29.21	3815.48
	7-Nov-2016				28.80	3815.89
	15-Aug-2016				28.80	3815.89
	17-May-2016				29.82	3814.87
	9-Feb-2016				29.95	3814.74
	5-Nov-2015				29.75	3814.94
	5-Aug-2015				29.41	3815.28
	7-May-2015				29.77	3814.92
	5-Feb-2015				29.23	3815.46
	10-Nov-2014				28.96	3815.73
	13-Aug-2014				27.44	3817.25
	13-May-2014				28.53	3816.16
	12-Feb-2014				27.97	3816.72
	6-Nov-2013				26.34	3818.35
	14-Aug-2013				26.66	3818.03
7-May-2013	26.53	3818.16				
7-Feb-2013	26.48	3818.21				
24-Oct-2012	25.91	3818.78				
31-Jul-2012	25.05	3819.64				
23-Apr-2012	25.46	3819.23				
26-Jan-2012	25.71	3818.98				
8-Dec-2011	25.35	3819.34				
19-Jul-2011	23.15	3821.54				
19-Apr-2011	22.80	3821.89				
18-Jan-2011	23.30	3821.39				
15-Sep-2010	22.34	3822.35				
24-Jun-2010	22.84	3821.85				
22-Mar-2010	23.16	3821.53				
8-Dec-2009	22.87	3821.82				
28-Aug-2009	22.43	3822.26				
26-May-2009	22.73	3821.96				
11-Dec-2008	22.91	3821.78				
27-Sep-2008	22.28	3822.41				
10-Jun-2008	23.12	3821.57				
6-Feb-2008	23.43	3821.26				
13-Nov-2007	23.00	3821.69				
12-Sep-2007	23.15	3821.54				

**TABLE 1. SUMMARY OF MONITORING WELL FLUID GAUGING DATA
DONA ANA DAIRIES, DONA ANA COUNTY, NEW MEXICO**

Monitoring Well	Date Measured	Northing ^a	Easting ^a	Casing Elevation ^b	Depth to Water ^c	Ground Water Elevation ^b
42-03	2-May-2023	419710.55	1514064.35	3898.46	87.33	3811.13
	2-Feb-2023				86.55	3811.91
	1-Nov-2022				86.76	3811.70
	1-Aug-2022				87.08	3811.38
	2-May-2022				86.28	3812.18
	7-Feb-2022				85.42	3813.04
	1-Nov-2021				85.70	3812.76
	4-Aug-2021				85.65	3812.81
	3-May-2021				85.15	3813.31
	10-Feb-2021				84.76	3813.70
	2-Nov-2020				85.01	3813.45
	10-Aug-2020				85.60	3812.86
	11-May-2020				85.01	3813.45
	4-Feb-2020				84.90	3813.56
	8-Nov-2019				84.22	3814.24
	5-Aug-2019				84.22	3814.24
	24-Jan-1900				86.35	3812.11
	8-May-2019				85.82	3812.64
	19-Feb-2019				85.05	3813.41
	13-Nov-2018				85.10	3813.36
	6-Aug-2018				85.91	3812.55
	17-May-2018				87.46	3811.00
	6-Feb-2018				84.66	3813.80
	7-Nov-2017				85.30	3813.16
	8-Aug-2017				86.20	3812.26
	15-May-2017				86.58	3811.88
	6-Feb-2017				85.27	3813.19
	7-Nov-2016				85.99	3812.47
	15-Aug-2016				86.55	3811.91
	17-May-2016				86.96	3811.50
	9-Feb-2016				85.37	3813.09
	5-Nov-2015				85.63	3812.83
	5-Aug-2015				87.05	3811.41
	7-May-2015				86.30	3812.16
	5-Feb-2015				84.36	3814.10
	10-Nov-2014				84.63	3813.83
	12-Aug-2014				84.73	3813.73
	13-May-2014				85.05	3813.41
	12-Feb-2014				83.40	3815.06
	6-Nov-2013				83.89	3814.57
	6-Aug-2013				82.46	3816.00
	7-May-2013				81.97	3816.49
7-Feb-2013	82.01	3816.45				
24-Oct-2012	82.70	3815.76				
31-Jul-2012	82.49	3815.97				
23-Apr-2012	81.57	3816.89				
25-Jan-2012	81.18	3817.28				
8-Dec-2011	81.26	3817.20				
19-Jul-2011	81.33	3817.13				
19-Apr-2011	80.21	3818.25				
18-Jan-2011	79.33	3819.13				
15-Sep-2010	79.91	3818.55				
24-Jun-2010	81.12	3817.34				
22-Mar-2010	79.57	3818.89				
8-Dec-2009	79.12	3819.34				
28-Aug-2009	79.26	3819.20				
26-May-2009	79.42	3819.04				
11-Dec-2008	78.89	3819.57				
27-Sep-2008	78.91	3819.55				
10-Jun-2008	79.91	3818.55				
6-Feb-2008	79.76	3818.70				
13-Nov-2007	79.15	3819.31				
12-Sep-2007	79.71	3818.75				

**TABLE 1. SUMMARY OF MONITORING WELL FLUID GAUGING DATA
DONA ANA DAIRIES, DONA ANA COUNTY, NEW MEXICO**

Monitoring Well	Date Measured	Northing ^a	Easting ^a	Casing Elevation ^b	Depth to Water ^c	Ground Water Elevation ^b
42-06	2-May-2023	420021.61	1511465.15	3850.15	37.20	3812.95
	3-Feb-2023				36.70	3813.45
	2-Nov-2022				35.12	3815.03
	2-Aug-2022				34.50	3815.65
	2-May-2022				35.31	3814.84
	7-Feb-2022				34.99	3815.16
	1-Nov-2021				34.02	3816.13
	4-Aug-2021				33.34	3816.81
	3-May-2021				33.76	3816.39
	10-Feb-2021				33.36	3816.79
	2-Nov-2020				32.96	3817.19
	10-Aug-2020				33.85	3816.30
	11-May-2020				34.55	3815.60
	4-Feb-2020				33.84	3816.31
	8-Nov-2019				31.38	3818.77
	5-Aug-2019				33.42	3816.73
	8-May-2019				33.80	3816.35
	19-Feb-2019				33.60	3816.55
	13-Nov-2018				33.29	3816.86
	6-Aug-2018				32.20	3817.95
	17-May-2018				34.08	3816.07
	6-Feb-2018				33.35	3816.80
	7-Nov-2017				33.54	3816.61
	8-Aug-2017				33.90	3816.25
	15-May-2017				34.92	3815.23
	6-Feb-2017				35.16	3814.99
	7-Nov-2016				34.93	3815.22
	15-Aug-2016				35.07	3815.08
	17-May-2016				35.91	3814.24
	9-Feb-2016				35.80	3814.35
	5-Nov-2015				35.37	3814.78
	5-Aug-2015				35.52	3814.63
	7-May-2015				35.70	3814.45
	5-Feb-2015				35.08	3815.07
	10-Nov-2014				34.83	3815.32
	13-Aug-2014				33.65	3816.50
	13-May-2014				34.50	3815.65
	12-Feb-2014				33.85	3816.30
	6-Nov-2013				31.68	3818.47
	6-Aug-2013				31.24	3818.91
7-May-2013	32.71	3817.44				
7-Feb-2013	32.30	3817.85				
24-Oct-2012	31.80	3818.35				
31-Jul-2012	31.15	3819.00				
23-Apr-2012	31.37	3818.78				
25-Jan-2012	31.51	3818.64				
8-Dec-2011	31.19	3818.96				
19-Jul-2011	29.37	3820.78				
19-Apr-2011	29.66	3820.49				
18-Jan-2011	29.18	3820.97				
15-Sep-2010	28.36	3821.79				
24-Jun-2010	28.96	3821.19				
22-Mar-2010	29.04	3821.11				
8-Dec-2009	28.90	3821.25				
28-Aug-2009	28.44	3821.71				
26-May-2009	28.70	3821.45				
11-Dec-2008	28.75	3821.40				
27-Sep-2008	28.27	3821.88				
10-Jun-2008	29.03	3821.12				
6-Feb-2008	29.24	3820.91				
13-Nov-2007	28.87	3821.28				
12-Sep-2007	29.03	3821.12				

**TABLE 1. SUMMARY OF MONITORING WELL FLUID GAUGING DATA
DONA ANA DAIRIES, DONA ANA COUNTY, NEW MEXICO**

Monitoring Well	Date Measured	Northing ^a	Easting ^a	Casing Elevation ^b	Depth to Water ^c	Ground Water Elevation ^b
42-07	10-Nov-2020	420584.8	1513076.66	3891.52	Plugged and Abandoned	
	2-Nov-2020				Dry	
	10-Aug-2020				Dry	
	11-May-2020				Dry	
	4-Feb-2020				Dry	
	8-Nov-2019				Dry	
	5-Aug-2019				Dry	
	8-May-2019				Dry	
	19-Feb-2019				Dry	
	13-Nov-2018				Dry	
	6-Aug-2018				Dry	
	17-May-2018				Dry	
	6-Feb-2018				Dry	
	7-Nov-2017				Dry	
	8-Aug-2017				Dry	
	15-May-2017				Dry	
	6-Feb-2017				Dry	
	7-Nov-2016				Dry	
	15-Aug-2016				Dry	
	17-May-2016				Dry	
	9-Feb-2016				Dry	
	5-Nov-2015				Dry	
	5-Aug-2015				Dry	
	7-May-2015				Dry	
	5-Feb-2015				Dry	
	10-Nov-2014				Dry	
	13-Aug-2014				Dry	
	13-May-2014				Dry	
	12-Feb-2014				Dry	
	6-Nov-2013				Dry	
	6-Aug-2013				Dry	
	7-May-2013				Dry	
	7-Feb-2013				Dry	
	24-Oct-2012				Dry	
	31-Jul-2012				Dry	
	23-Apr-2012				Dry	
	25-Jan-2012				Dry	
	8-Dec-2011				Dry	
	19-Jul-2011				Dry	
	19-Apr-2011				72.19	3819.33
	18-Jan-2011				71.37	3820.15
	15-Sep-2010				71.64	3819.88
24-Jun-2010	72.24	3819.28				
22-Mar-2010	71.43	3820.09				
8-Dec-2009	71.26	3820.26				
28-Aug-2009	71.26	3820.26				
26-May-2009	71.31	3820.21				
11-Dec-2008	70.87	3820.65				
27-Sep-2008	70.95	3820.57				
10-Jun-2008	71.71	3819.81				
6-Feb-2008	71.00	3820.52				
13-Nov-2007	71.12	3820.40				
12-Sep-2007	71.61	3819.91				

**TABLE 1. SUMMARY OF MONITORING WELL FLUID GAUGING DATA
DONA ANA DAIRIES, DONA ANA COUNTY, NEW MEXICO**

Monitoring Well	Date Measured	Northing ^a	Easting ^a	Casing Elevation ^b	Depth to Water ^c	Ground Water Elevation ^b				
42-08	2-May-2023	419994.93	1511197.91	3846.53	31.91	3814.62				
	3-Feb-2023				31.68	3814.85				
	2-Nov-2022				31.00	3815.53				
	2-Aug-2022				30.10	3816.43				
	2-May-2022				31.00	3815.53				
	7-Feb-2022				30.20	3816.33				
	1-Nov-2021				29.71	3816.82				
	4-Aug-2021				29.05	3817.48				
	3-May-2021				29.60	3816.93				
	10-Feb-2021				29.08	3817.45				
	2-Nov-2020				28.44	3818.09				
	10-Aug-2020				29.93	3816.60				
	11-May-2020				30.63	3815.90				
	4-Feb-2020				29.72	3816.81				
	8-Nov-2019				28.12	3818.41				
	5-Aug-2019				29.08	3817.45				
	8-May-2019				29.61	3816.92				
	19-Feb-2019				29.42	3817.11				
	13-Nov-2018				29.14	3817.39				
	6-Aug-2018				27.74	3818.79				
	17-May-2018				29.88	3816.65				
	6-Feb-2018				29.20	3817.33				
	7-Nov-2017				29.37	3817.16				
	8-Aug-2017				29.53	3817.00				
	15-May-2017				30.80	3815.73				
	6-Feb-2017				31.22	3815.31				
	7-Nov-2016				30.87	3815.66				
	15-Aug-2016				30.90	3815.63				
	17-May-2016								Dry	
	9-Feb-2016								Dry	
	5-Nov-2015								Dry	
	5-Aug-2015								31.45	3815.08
	7-May-2015								31.77	3814.76
	5-Feb-2015								31.23	3815.30
	10-Nov-2014								30.97	3815.56
	13-Aug-2014								29.54	3816.99
	13-May-2014								30.68	3815.85
	12-Feb-2014								29.98	3816.55
	6-Nov-2013								28.26	3818.27
	6-Aug-2013								27.97	3818.56
	7-May-2013								28.69	3817.84
	7-Feb-2013								28.43	3818.10
	24-Oct-2012								27.92	3818.61
	31-Jul-2012								27.11	3819.42
	23-Apr-2012								27.51	3819.02
	26-Jan-2012								27.68	3818.85
	8-Dec-2011								27.33	3819.20
	19-Jul-2011								25.24	3821.29
	19-Apr-2011								25.72	3820.81
	18-Jan-2011								25.28	3821.25
15-Sep-2010					24.37	3822.16				
24-Jun-2010					24.91	3821.62				
22-Mar-2010					25.15	3821.38				
8-Dec-2009					24.91	3821.62				
28-Aug-2009					24.46	3822.07				
26-May-2009					24.75	3821.78				
11-Dec-2008					24.88	3821.65				
27-Sep-2008					24.30	3822.23				
10-Jun-2008					25.13	3821.40				
6-Feb-2008					25.41	3821.12				
13-Nov-2007					25.00	3821.53				
12-Sep-2007					25.13	3821.40				

**TABLE 1. SUMMARY OF MONITORING WELL FLUID GAUGING DATA
DONA ANA DAIRIES, DONA ANA COUNTY, NEW MEXICO**

Monitoring Well	Date Measured	Northing ^a	Easting ^a	Casing Elevation ^b	Depth to Water ^c	Ground Water Elevation ^b
42-09	4-Feb-2020	419729.17	1512255.76	3865.25	Damaged	
	8-Nov-2019				47.03	-47.03
	5-Aug-2019				49.72	3815.53
	8-May-2019				49.76	-49.76
	19-Feb-2019				49.69	-49.69
	13-Nov-2018				49.30	3815.95
	6-Aug-2018				48.59	3816.66
	17-May-2018				50.22	-50.22
	6-Feb-2018				49.37	-49.37
	7-Nov-2017				49.53	-49.53
	8-Aug-2017				50.35	-50.35
	15-May-2017				50.78	-50.78
	6-Feb-2017				50.95	-50.95
	7-Nov-2016				50.98	-50.98
	15-Aug-2016				51.29	-51.29
	17-May-2016				51.73	-51.73
	9-Feb-2016				51.39	-51.39
	5-Nov-2015				Damaged	
	5-Aug-2015				51.34	-51.34
	7-May-2015				51.23	-51.23
	5-Feb-2015				50.51	-50.51
	10-Nov-2014				50.21	-50.21
	12-Aug-2014				49.45	-49.45
	13-May-2014				49.85	-49.85
	12-Feb-2014				49.36	-49.36
	6-Nov-2013				48.23	-48.23
	6-Aug-2013				47.88	-47.88
	7-May-2013				48.04	-48.04
	7-Feb-2013				47.79	-47.79
	24-Oct-2012				47.29	-47.29
	31-Jul-2012				46.98	-46.98
	23-Apr-2012				46.93	-46.93
	25-Jan-2012				46.95	3818.30
	8-Dec-2011				46.76	-46.76
	19-Jul-2011				45.54	3819.71
	19-Apr-2011				45.38	3819.87
	18-Jan-2011				44.87	3820.38
	15-Sep-2010				44.21	-44.21
	24-Jun-2010				44.99	-44.99
	22-Mar-2010				44.72	-44.72
	8-Dec-2009				44.70	-44.70
28-Aug-2009	44.32	-44.32				
26-May-2009	44.50	-44.50				
11-Dec-2008	44.39	-44.39				
27-Sep-2008	44.12	-44.12				
10-Jun-2008	44.77	-44.77				
6-Feb-2008	44.80	-44.80				
13-Nov-2007	44.47	-44.47				
12-Sep-2007	44.73	-44.73				

**TABLE 1. SUMMARY OF MONITORING WELL FLUID GAUGING DATA
DONA ANA DAIRIES, DONA ANA COUNTY, NEW MEXICO**

Monitoring Well	Date Measured	Northing ^a	Easting ^a	Casing Elevation ^b	Depth to Water ^c	Ground Water Elevation ^b
42-10	2-May-2023	421426.39	1514460.4	3929.28	118.32	3810.96
	3-Feb-2023				117.50	3811.78
	2-Nov-2022				118.25	3811.03
	2-Aug-2022				118.04	3811.24
	3-May-2022				117.20	3812.08
	8-Feb-2022				116.40	3812.88
	1-Nov-2021				117.11	3812.17
	4-Aug-2021				117.00	3812.28
	3-May-2021				116.57	3812.71
	10-Feb-2021				116.63	3812.65
	3-Nov-2020				116.93	3812.35
	10-Aug-2020				117.88	3811.40
	11-May-2020				117.22	3812.06
	5-Feb-2020				116.05	3813.23
	25-Nov-2019				116.94	3812.34
	5-Aug-2019				117.70	3811.58
	8-May-2019				117.06	3812.22
	19-Feb-2019				116.10	3813.18
	13-Nov-2018				116.55	3812.73
	6-Aug-2018				117.51	3811.77
	17-May-2018				117.25	3812.03
	6-Feb-2018				115.60	3813.68
	7-Nov-2017				116.45	3812.83
	9-Aug-2017				117.45	3811.83
	15-May-2017				117.22	3812.06
	6-Feb-2017				115.88	3813.40
	7-Nov-2016				116.40	3812.88
	15-Aug-2016				117.36	3811.92
	17-May-2016				117.40	3811.88
	9-Feb-2016				115.85	3813.43
	5-Nov-2015				116.29	3812.99
	5-Aug-2015				117.00	3812.28
	12-May-2015				116.10	3813.18
	6-Feb-2015				114.95	3814.33
	10-Nov-2014				115.52	3813.76
	14-Aug-2014				115.37	3813.91
	13-May-2014				115.15	3814.13
	12-Feb-2014				113.97	3815.31
	6-Nov-2013				115.21	3814.07
	6-Aug-2013				113.03	3816.25
7-May-2013	112.81	3816.47				
7-Feb-2013	112.29	3816.99				
24-Oct-2012	112.95	3816.33				
31-Jul-2012	112.87	3816.41				
23-Apr-2012	111.87	3817.41				
25-Jan-2012	110.98	3818.30				
8-Dec-2011	111.16	3818.12				
19-Jul-2011	111.21	3818.07				
19-Apr-2011	110.06	3819.22				
18-Jan-2011	109.19	3820.09				
15-Sep-2010	110.24	3819.04				
27-Jun-2010	110.35	3818.93				
22-Mar-2010	109.47	3819.81				
8-Dec-2009	109.41	3819.87				
28-Aug-2009	109.67	3819.61				
26-May-2009	109.53	3819.75				
11-Dec-2008	109.00	3820.28				
27-Sep-2008	109.49	3819.79				
11-Jun-2008	109.88	3819.40				
6-Feb-2008	108.98	3820.30				
14-Nov-2007	109.36	3819.92				
12-Sep-2007	109.92	3819.36				

**TABLE 1. SUMMARY OF MONITORING WELL FLUID GAUGING DATA
DONA ANA DAIRIES, DONA ANA COUNTY, NEW MEXICO**

Monitoring Well	Date Measured	Northing ^a	Easting ^a	Casing Elevation ^b	Depth to Water ^c	Ground Water Elevation ^b
42-11	2-May-2023	420693.98	1515270.32	3939.31	129.00	3810.31
	3-Feb-2023				128.02	3811.29
	2-Nov-2022				127.15	3812.16
	2-Aug-2022				127.20	3812.11
	3-May-2022				127.95	3811.36
	8-Feb-2022				127.03	3812.28
	1-Nov-2021				127.62	3811.69
	4-Aug-2021				127.46	3811.85
	3-May-2021				127.07	3812.24
	10-Feb-2021				126.91	3812.40
	3-Nov-2020				127.37	3811.94
	10-Aug-2020				127.65	3811.66
	11-May-2020				127.06	3812.25
	4-Feb-2020				126.66	3812.65
	8-Nov-2019				126.63	3812.68
	5-Aug-2019				127.96	3811.35
	8-May-2019				127.35	3811.96
	19-Feb-2019				126.61	3812.70
	13-Nov-2018				127.35	3811.96
	6-Aug-2018				127.90	3811.41
	17-May-2018				127.49	3811.82
	6-Feb-2018				126.31	3813.00
	7-Nov-2017				127.08	3812.23
	8-Aug-2017				127.76	3811.55
	15-May-2017				127.55	3811.76
	6-Feb-2017				126.48	3812.83
	7-Nov-2016				127.48	3811.83
	15-Aug-2016				127.82	3811.49
	17-May-2016				127.50	3811.81
	9-Feb-2016				126.40	3812.91
	5-Nov-2015				126.80	3812.51
	5-Aug-2015				127.08	3812.23
	12-May-2015				126.42	3812.89
	6-Feb-2015				125.43	3813.88
	10-Nov-2014				125.97	3813.34
	14-Aug-2014				125.85	3813.46
	13-May-2014				125.27	3814.04
	12-Feb-2014				123.96	3815.35
	6-Nov-2013				125.37	3813.94
	6-Aug-2013				124.06	3815.25
	7-May-2013				123.24	3816.07
	7-Feb-2013				122.91	3816.40
24-Oct-2012	123.44	3815.87				
31-Jul-2012	123.11	3816.20				
23-Apr-2012	122.09	3817.22				
25-Jan-2012	121.67	3817.64				
8-Dec-2011	121.83	3817.48				
19-Jul-2011	121.73	3817.58				
19-Apr-2011	120.64	3818.67				
18-Jan-2011	120.01	3819.30				
15-Sep-2010	121.02	3818.29				
27-Jun-2010	121.05	3818.26				
22-Mar-2010	120.18	3819.13				
8-Dec-2009	120.21	3819.10				
28-Aug-2009	120.51	3818.80				
26-May-2009	120.35	3818.96				
11-Dec-2008	119.88	3819.43				
27-Sep-2008	120.29	3819.02				
11-Jun-2008	120.57	3818.74				
6-Feb-2008	119.84	3819.47				
14-Nov-2007	120.24	3819.07				
12-Sep-2007	120.74	3818.57				

**TABLE 1. SUMMARY OF MONITORING WELL FLUID GAUGING DATA
DONA ANA DAIRIES, DONA ANA COUNTY, NEW MEXICO**

Monitoring Well	Date Measured	Northing ^a	Easting ^a	Casing Elevation ^b	Depth to Water ^c	Ground Water Elevation ^b
42-12	2-May-2023	420972.09	1515423.88	3945.83	135.42	3810.41
	3-Feb-2023				134.54	3811.29
	2-Nov-2022				134.90	3810.93
	2-Aug-2022				135.02	3810.81
	3-May-2022				134.33	3811.50
	8-Feb-2022				133.50	3812.33
	1-Nov-2021				134.00	3811.83
	4-Aug-2021				133.90	3811.93
	3-May-2021				132.96	3812.87
	10-Feb-2021				132.50	3813.33
	3-Nov-2020				133.95	3811.88
	10-Aug-2020				134.78	3811.05
	11-May-2020				134.13	3811.70
	5-Feb-2020				133.30	3812.53
	8-Nov-2019				133.01	3812.82
	5-Aug-2019				134.50	3811.33
	8-May-2019				133.01	3812.82
	19-Feb-2019				133.15	3812.68
	13-Nov-2018				133.90	3811.93
	6-Aug-2018				134.45	3811.38
	17-May-2018				133.95	3811.88
	6-Feb-2018				132.89	3812.94
	7-Nov-2017				133.64	3812.19
	8-Aug-2017				Not accessible	
	15-May-2017				133.90	3811.93
	6-Feb-2017				132.92	3812.91
	7-Nov-2016				133.88	3811.95
	15-Aug-2016				134.14	3811.69
	17-May-2016				133.77	3812.06
	9-Feb-2016				132.75	3813.08
	5-Nov-2015				133.16	3812.67
	5-Aug-2015				134.36	3811.47
	7-May-2015				133.05	3812.78
	6-Feb-2015				131.76	3814.07
	10-Nov-2014				132.31	3813.52
	14-Aug-2014				132.13	3813.70
	13-May-2014				131.63	3814.20
	12-Feb-2014				129.89	3815.94
	6-Nov-2013				131.11	3814.72
	6-Aug-2013				130.08	3815.75
	7-May-2013				129.59	3816.24
	7-Feb-2013				129.18	3816.65
	24-Oct-2012				129.74	3816.09
	31-Jul-2012				129.44	3816.39
	23-Apr-2012				128.71	3817.12
	25-Jan-2012				128.06	3817.77
	8-Dec-2011				128.14	3817.69
19-Jul-2011	128.01	3817.82				
19-Apr-2011	126.37	3819.46				
18-Jan-2011	126.37	3819.46				
15-Sep-2010	127.38	3818.45				
27-Jun-2010	127.43	3818.40				
22-Mar-2010	126.50	3819.33				
8-Dec-2009	126.60	3819.23				
28-Aug-2009	126.84	3818.99				
26-May-2009	126.68	3819.15				
11-Dec-2008	126.18	3819.65				
27-Sep-2008	126.68	3819.15				
11-Jun-2008	126.88	3818.95				
6-Feb-2008	126.16	3819.67				
14-Nov-2007	126.55	3819.28				
12-Sep-2007	127.04	3818.79				

**TABLE 1. SUMMARY OF MONITORING WELL FLUID GAUGING DATA
DONA ANA DAIRIES, DONA ANA COUNTY, NEW MEXICO**

Monitoring Well	Date Measured	Northing ^a	Easting ^a	Casing Elevation ^b	Depth to Water ^c	Ground Water Elevation ^b
42-13	2-May-2023	419734.06	1512534.42	3873.10	60.01	3813.09
	2-Feb-2023				59.06	3814.04
	1-Nov-2022				58.81	3814.29
	2-Aug-2022				58.90	3814.20
	3-May-2022				59.28	3813.82
	7-Feb-2022				58.97	3814.13
	1-Nov-2021				58.53	3814.57
	4-Aug-2021				58.00	3815.10
	3-May-2021				58.10	3815.00
	10-Feb-2021				57.91	3815.19
	2-Nov-2020				58.66	3814.44
	10-Aug-2020				59.05	3814.05
	11-May-2020				59.66	3813.44
	4-Feb-2020				58.05	3815.05
	8-Nov-2019				57.05	3816.05
	5-Aug-2019				58.25	3814.85
	8-May-2019				58.22	3814.88
	19-Feb-2019				58.10	3815.00
	13-Nov-2018				57.70	3815.40
	6-Aug-2018				57.18	3815.92
	17-May-2018				58.70	3814.40
	6-Feb-2017				57.77	3815.33
	7-Nov-2017				57.98	3815.12
	8-Aug-2017				58.75	3814.35
	15-May-2017				59.15	3813.95
	6-Feb-2017				58.90	3814.20
	7-Nov-2016				59.00	3814.10
	15-Aug-2016				59.40	3813.70
	17-May-2016				59.73	3813.37
	9-Feb-2016				59.30	3813.80
	5-Nov-2015				59.28	3813.82
	5-Aug-2015				59.04	3814.06
	7-May-2015				59.37	3813.73
	5-Feb-2015				58.50	3814.60
	10-Nov-2014				57.27	3815.83
	12-Aug-2014				57.56	3815.54
	13-May-2014				57.95	3815.15
	17-Feb-2014				57.38	3815.72
	6-Nov-2013				56.31	3816.79
	6-Aug-2013				56.01	3817.09
7-May-2013	56.02	3817.08				
7-Feb-2013	55.86	3817.24				
24-Oct-2012	55.40	3817.70				
31-Jul-2012	55.17	3817.93				
23-Apr-2012	54.96	3818.14				
25-Jan-2012	54.99	3818.11				
8-Dec-2011	54.83	3818.27				
19-Jul-2011	53.77	3819.33				
19-Apr-2011	53.50	3819.60				
18-Jan-2011	52.95	3820.15				
15-Sep-2010	52.44	3820.66				
24-Jun-2010	53.21	3819.89				
22-Mar-2010	52.84	3820.26				
8-Dec-2009	52.79	3820.31				
28-Aug-2009	52.45	3820.65				
26-May-2009	52.64	3820.46				
11-Dec-2008	52.49	3820.61				
27-Sep-2008	52.23	3820.87				
10-Jun-2008	52.91	3820.19				
6-Feb-2008	52.84	3820.26				
13-Nov-2007	52.56	3820.54				
12-Sep-2007	52.83	3820.27				

**TABLE 1. SUMMARY OF MONITORING WELL FLUID GAUGING DATA
DONA ANA DAIRIES, DONA ANA COUNTY, NEW MEXICO**

Monitoring Well	Date Measured	Northing ^a	Easting ^a	Casing Elevation ^b	Depth to Water ^c	Ground Water Elevation ^b
Dominguez Dairy						
624-01	2-May-2023	418826.21	1512131.46	3843.72	30.70	3813.02
	3-Feb-2023				29.80	3813.92
	2-Nov-2022				29.05	3814.67
	2-Aug-2022				28.18	3815.54
	3-May-2022				28.80	3814.92
	8-Feb-2022				28.95	3814.77
	2-Nov-2021				28.08	3815.64
	5-Aug-2021				27.22	3816.50
	4-May-2021				27.13	3816.59
	11-Feb-2021				26.27	3817.45
	3-Nov-2020				25.95	3817.77
	11-Aug-2020				26.11	3817.61
	11-May-2020				26.96	3816.76
	5-Feb-2020				27.62	3816.10
	8-Nov-2019				26.82	3816.90
	1-Aug-2019				27.30	3816.42
	8-May-2019				26.50	3817.22
	19-Feb-2019				27.80	3815.92
	12-Nov-2018				27.03	3816.69
	6-Aug-2018				24.25	3819.47
	14-May-2018				26.91	3816.81
	5-Feb-2018				27.43	3816.29
	6-Nov-2017				27.11	3816.61
	7-Aug-2017				27.76	3815.96
	15-May-2017				28.08	3815.64
	7-Feb-2017				29.10	3814.62
	7-Nov-2016				28.41	3815.31
	15-Aug-2016				28.49	3815.23
	16-May-2016				28.53	3815.19
	9-Feb-2016				29.47	3814.25
	5-Nov-2015				29.23	3814.49
	5-Aug-2015				28.20	3815.52
	6-May-2015				28.06	3815.66
	5-Feb-2015				28.95	3814.77
	10-Nov-2014				28.24	3815.48
	12-Aug-2014				26.64	3817.08
	12-May-2014				27.38	3816.34
	12-Feb-2014				28.10	3815.62
	7-Nov-2013				26.34	3817.38
	6-Aug-2013				25.98	3817.74
7-May-2013	26.21	3817.51				
7-Feb-2013	26.39	3817.33				
24-Oct-2012	25.89	3817.83				
30-Jul-2012	26.12	3817.60				
24-Apr-2012	26.02	3817.70				
25-Jan-2012	25.51	3818.21				
7-Dec-2011	25.19	3818.53				
19-Jul-2011	23.22	3820.50				
19-Apr-2011	23.75	3819.97				
18-Jan-2011	23.53	3820.19				
15-Sep-2010	21.40	3822.32				
24-Jun-2010	22.48	3821.24				
22-Mar-2010	22.83	3820.89				
8-Dec-2009	23.33	3820.39				
28-Aug-2009	22.72	3821.00				
27-May-2009	22.92	3820.80				
11-Dec-2008	23.11	3820.61				
27-Sep-2008	22.62	3821.10				
10-Jun-2008	22.72	3821.00				
5-Feb-2008	23.64	3820.08				
13-Nov-2007	22.87	3820.85				
12-Sep-2007	22.94	3820.78				

**TABLE 1. SUMMARY OF MONITORING WELL FLUID GAUGING DATA
DONA ANA DAIRIES, DONA ANA COUNTY, NEW MEXICO**

Monitoring Well	Date Measured	Northing ^a	Easting ^a	Casing Elevation ^b	Depth to Water ^c	Ground Water Elevation ^b
624-02	2-May-2023	417335.25	1512201.42	3835.45	22.32	3813.13
	3-Feb-2023				21.96	3813.49
	2-Nov-2022				21.20	3814.25
	2-Aug-2022				19.69	3815.76
	3-May-2022				20.50	3814.95
	8-Feb-2022				20.90	3814.55
	2-Nov-2021				20.10	3815.35
	5-Aug-2021				19.47	3815.98
	4-May-2021				19.30	3816.15
	11-Feb-2021				18.88	3816.57
	3-Nov-2020				17.89	3817.56
	11-Aug-2020				18.39	3817.06
	11-May-2020				19.89	3815.56
	5-Feb-2020				19.00	3816.45
	8-Nov-2019				17.77	3817.68
	1-Aug-2019				18.65	3816.80
	8-May-2019				18.42	3817.03
	19-Feb-2019				18.42	3817.03
	12-Nov-2018				18.67	3816.78
	6-Aug-2018				14.48	3820.97
	14-May-2018				19.04	3816.41
	5-Feb-2017				19.15	3816.30
	6-Nov-2017				18.33	3817.12
	8-Aug-2017				18.42	3817.03
	15-May-2017				19.94	3815.51
	7-Feb-2017				20.87	3814.58
	7-Nov-2016				19.47	3815.98
	15-Aug-2016				19.06	3816.39
	16-May-2016				20.57	3814.88
	9-Feb-2016				21.36	3814.09
	5-Nov-2015				20.82	3814.63
	5-Aug-2015				19.45	3816.00
	6-May-2015				19.81	3815.64
	5-Feb-2015				20.95	3814.50
	6-Nov-2014				19.65	3815.80
	12-Aug-2014				19.12	3816.33
	12-May-2014				19.00	3816.45
	12-Feb-2014				20.00	3815.45
	7-Nov-2013				18.60	3816.85
	6-Aug-2013				18.83	3816.62
	7-May-2013				19.01	3816.44
	7-Feb-2013				19.10	3816.35
	24-Oct-2012				18.85	3816.60
	30-Jul-2012				18.59	3816.86
	23-Apr-2012				17.97	3817.48
	24-Jan-2012				17.16	3818.29
	7-Dec-2011				17.30	3818.15
19-Jul-2011	15.23	3820.22				
19-Apr-2011	15.94	3819.51				
17-Jan-2011	15.66	3819.79				
20-Sep-2010	14.04	3821.41				
24-Jun-2010	13.93	3821.52				
22-Mar-2010	15.24	3820.21				
8-Dec-2009	15.61	3819.84				
28-Aug-2009	14.85	3820.60				
27-May-2009	15.14	3820.31				
11-Dec-2008	15.47	3819.98				
27-Sep-2008	14.97	3820.48				
10-Jun-2008	14.87	3820.58				
5-Feb-2008	16.50	3818.95				
13-Nov-2007	15.40	3820.05				
12-Sep-2007	14.94	3820.51				

**TABLE 1. SUMMARY OF MONITORING WELL FLUID GAUGING DATA
DONA ANA DAIRIES, DONA ANA COUNTY, NEW MEXICO**

Monitoring Well	Date Measured	Northing ^a	Easting ^a	Casing Elevation ^b	Depth to Water ^c	Ground Water Elevation ^b
624-04	28-Jan-2020	418542.24	1508104.07	3835.69	Plugged and Abandoned	
	8-Nov-2019				Dry	
	1-Aug-2019				Dry	
	8-May-2019				Dry	
	19-Feb-2019				Dry	
	12-Nov-2018				Dry	
	6-Aug-2018				Dry	
	14-May-2018				Dry	
	5-Feb-2017				Dry	
	6-Nov-2017				Dry	
	7-Aug-2017				Dry	
	15-May-2017				Dry	
	7-Feb-2017				Dry	
	7-Nov-2016				Dry	
	15-Aug-2016				Dry	
	16-May-2016				Dry	
	9-Feb-2016				Dry	
	5-Nov-2015				Dry	
	5-Aug-2015				Dry	
	6-May-2015				Dry	
	5-Feb-2015				Dry	
	6-Nov-2014				Dry	
	12-Aug-2014				Dry	
	12-May-2014				Dry	
	12-Feb-2014				Dry	
	7-Nov-2013				Dry	
	6-Aug-2013				Dry	
	7-May-2013				Dry	
	7-Feb-2013				Dry	
	24-Oct-2012				Dry	
	30-Jul-2012				Dry	
	23-Apr-2012				Dry	
	25-Jan-2012				Dry	
	8-Dec-2011				Dry	
	19-Jul-2011				15.39	3820.30
	19-Apr-2011				13.66	3822.03
	18-Jan-2011				13.99	3821.70
	15-Sep-2010				11.43	3824.26
	24-Jun-2010				13.49	3822.20
	22-Mar-2010				14.83	3820.86
8-Dec-2009	13.48	3822.21				
28-Aug-2009	12.49	3823.20				
26-May-2009	12.89	3822.80				
11-Dec-2008	12.99	3822.70				
27-Sep-2008	12.31	3823.38				
10-Jun-2008	14.45	3821.24				
5-Feb-2008	14.13	3821.56				
13-Nov-2007	13.60	3822.09				
12-Sep-2007	14.83	3820.86				

**TABLE 1. SUMMARY OF MONITORING WELL FLUID GAUGING DATA
DONA ANA DAIRIES, DONA ANA COUNTY, NEW MEXICO**

Monitoring Well	Date Measured	Northing ^a	Easting ^a	Casing Elevation ^b	Depth to Water ^c	Ground Water Elevation ^b
624-05	28-Jan-2020	419777.52	1509829.65	3835.27	Plugged and Abandoned	
	8-Nov-2019				15.87	3819.40
	1-Aug-2019				16.00	3819.27
	8-May-2019				16.60	3818.67
	19-Feb-2019				16.81	3818.46
	12-Nov-2018				Dry	
	6-Aug-2018				Dry	
	14-May-2018				Dry	
	5-Feb-2017				Dry	
	6-Nov-2017				Dry	
	7-Aug-2017				Dry	
	15-May-2017				Dry	
	7-Feb-2017				Dry	
	7-Nov-2016				Dry	
	15-Aug-2016				Dry	
	16-May-2016				Dry	
	9-Feb-2016				Dry	
	5-Nov-2015				Dry	
	5-Aug-2015				Dry	
	6-May-2015				Dry	
	5-Feb-2015				Dry	
	6-Nov-2014				Dry	
	12-Aug-2014				Dry	
	12-May-2014				Dry	
	12-Feb-2014				Dry	
	7-Nov-2013				Dry	
	6-Aug-2013				Dry	
	7-May-2013				Dry	
	7-Feb-2013				16.72	3818.55
	24-Oct-2012				16.35	3818.92
	30-Jul-2012				15.89	3819.38
	23-Apr-2012				15.90	3819.37
	25-Jan-2012				15.81	3819.46
7-Dec-2011	15.25	3820.02				
3-Aug-2011	13.38	3821.89				
19-Apr-2011	13.86	3821.41				
18-Jan-2011	13.11	3822.16				
15-Sep-2010	12.01	3823.26				
24-Jun-2010	12.71	3822.56				
22-Mar-2010	13.21	3822.06				
8-Dec-2009	12.54	3822.73				
28-Aug-2009	12.03	3823.24				
26-May-2009	12.58	3822.69				
11-Dec-2008	12.82	3822.45				
27-Sep-2008	11.97	3823.30				
10-Jun-2008	13.19	3822.08				
5-Feb-2008	13.44	3821.83				
13-Nov-2007	13.01	3822.26				
12-Sep-2007	13.31	3821.96				

**TABLE 1. SUMMARY OF MONITORING WELL FLUID GAUGING DATA
DONA ANA DAIRIES, DONA ANA COUNTY, NEW MEXICO**

Monitoring Well	Date Measured	Northing ^a	Easting ^a	Casing Elevation ^b	Depth to Water ^c	Ground Water Elevation ^b
624-06	28-Jan-2020	418502.42	1513981.08	3868.18	Plugged and Abandoned	
	8-Nov-2019				Dry	
	1-Aug-2019				Dry	
	8-May-2019				Dry	
	19-Feb-2019				Dry	
	12-Nov-2018				Dry	
	6-Aug-2018				Dry	
	14-May-2018				Dry	
	5-Feb-2017				Dry	
	6-Nov-2017				Dry	
	7-Aug-2017				Dry	
	15-May-2017				Dry	
	7-Feb-2017				Dry	
	7-Nov-2016				Dry	
	15-Aug-2016				Dry	
	16-May-2016				Dry	
	9-Feb-2016				Dry	
	5-Nov-2015				Dry	
	5-Aug-2015				Dry	
	6-May-2015				Dry	
	5-Feb-2015				Dry	
	6-Nov-2014				Dry	
	12-Aug-2014				Dry	
	12-May-2014				Dry	
	12-Feb-2014				Dry	
	7-Nov-2013				Dry	
	6-Aug-2013				Dry	
	7-May-2013				Dry	
	7-Feb-2013				51.84	3816.34
	24-Oct-2012				51.99	3816.19
	30-Jul-2012				51.30	3816.88
	23-Apr-2012				51.83	3816.35
	25-Jan-2012				51.80	3816.38
	13-Dec-2011				50.89	3817.29
	19-Jul-2011				50.43	3817.75
	19-Apr-2011				49.79	3818.39
	18-Jan-2011				49.31	3818.87
	21-Sep-2010				48.73	3819.45
	24-Jun-2010				50.33	3817.85
	22-Mar-2010				49.62	3818.56
8-Dec-2009	48.96	3819.22				
28-Aug-2009	48.87	3819.31				
26-May-2009	49.14	3819.04				
11-Dec-2008	48.89	3819.29				
27-Sep-2008	48.71	3819.47				
10-Jun-2008	49.67	3818.51				
5-Feb-2008	49.11	3819.07				
13-Nov-2007	48.94	3819.24				
12-Sep-2007	49.17	3819.01				

**TABLE 1. SUMMARY OF MONITORING WELL FLUID GAUGING DATA
DONA ANA DAIRIES, DONA ANA COUNTY, NEW MEXICO**

Monitoring Well	Date Measured	Northing ^a	Easting ^a	Casing Elevation ^b	Depth to Water ^c	Ground Water Elevation ^b
624-07	28-Jan-2020	418012.23	1514707.77	3872.25	Plugged and Abandoned	
	8-Nov-2019				Dry	
	1-Aug-2019				Dry	
	8-May-2019				Dry	
	19-Feb-2019				Dry	
	12-Nov-2018				Dry	
	6-Aug-2018				Dry	
	14-May-2018				Dry	
	5-Feb-2017				Dry	
	6-Nov-2017				Dry	
	7-Aug-2017				55.68	3816.57
	15-May-2017				55.66	3816.59
	7-Feb-2017				55.67	3816.58
	7-Nov-2016				55.65	3816.60
	15-Aug-2016				55.60	3816.65
	20-May-2016				55.66	3816.59
	9-Feb-2016				Dry	
	5-Nov-2015				55.60	3816.65
	5-Aug-2015				55.56	3816.69
	6-May-2015				55.57	3816.68
	5-Feb-2015				55.53	3816.72
	6-Nov-2014				55.57	3816.68
	12-Aug-2014				55.68	3816.57
	12-May-2014				55.61	3816.64
	12-Feb-2014				55.62	3816.63
	7-Nov-2013				Dry	
	6-Aug-2013				Dry	
	7-May-2013				Dry	
	7-Feb-2013				Dry	
	24-Oct-2012				55.58	3816.67
	30-Jul-2012				55.47	3816.78
	23-Apr-2012				Dry	
	25-Jan-2012				55.50	3816.75
	13-Dec-2011				55.46	3816.79
	19-Jul-2011				54.55	3817.70
	19-Apr-2011				54.64	3817.61
	18-Jan-2011				53.91	3818.34
	15-Sep-2010				52.30	3819.95
	24-Jun-2010				55.27	3816.98
	22-Mar-2010				54.21	3818.04
	8-Dec-2009				53.32	3818.93
28-Aug-2009	53.22	3819.03				
26-May-2009	53.76	3818.49				
11-Dec-2008	53.59	3818.66				
27-Sep-2008	53.35	3818.90				
10-Jun-2008	54.34	3817.91				
5-Feb-2008	53.81	3818.44				
13-Nov-2007	53.26	3818.99				
12-Sep-2007	53.03	3819.22				

**TABLE 1. SUMMARY OF MONITORING WELL FLUID GAUGING DATA
DONA ANA DAIRIES, DONA ANA COUNTY, NEW MEXICO**

Monitoring Well	Date Measured	Northing ^a	Easting ^a	Casing Elevation ^b	Depth to Water ^c	Ground Water Elevation ^b
624-08	28-Jan-2020	421461.78	1507712.04	3838.70	Plugged and Abandoned	
	8-Nov-2019				Dry	
	1-Aug-2019				Dry	
	8-May-2019				Dry	
	19-Feb-2019				Dry	
	12-Nov-2018				Dry	
	6-Aug-2018				Dry	
	14-May-2018				Dry	
	5-Feb-2017				Dry	
	6-Nov-2017				Dry	
	7-Aug-2017				Dry	
	15-May-2017				Dry	
	7-Feb-2017				Dry	
	7-Nov-2016				Dry	
	15-Aug-2016				Dry	
	16-May-2016				Dry	
	9-Feb-2016				Dry	
	5-Nov-2015				Dry	
	5-Aug-2015				Dry	
	6-May-2015				Dry	
	5-Feb-2015				Dry	
	6-Nov-2014				Dry	
	12-Aug-2014				Dry	
	12-May-2014				Dry	
	12-Feb-2014				Dry	
	7-Nov-2013				Dry	
	6-Aug-2013				Dry	
	7-May-2013				Dry	
	7-Feb-2013				Dry	
	24-Oct-2012				Dry	
	30-Jul-2012				Dry	
	23-Apr-2012				Dry	
	25-Jan-2012				Dry	
	8-Dec-2011				Dry	
	3-Aug-2011				Dry	
	18-Apr-2011				17.72	3820.98
	18-Jan-2011				16.03	3822.67
	14-Sep-2010				14.83	3823.87
	24-Jun-2010				16.44	3822.26
	22-Mar-2010				16.42	3822.28
8-Dec-2009	16.02	3822.68				
28-Aug-2009	15.20	3823.50				
26-May-2009	15.54	3823.16				
11-Dec-2008	14.96	3823.74				
27-Sep-2008	14.84	3823.86				
10-Jun-2008	16.12	3822.58				
5-Feb-2008	15.37	3823.33				
13-Nov-2007	14.71	3823.99				
12-Sep-2007	15.33	3823.37				

**TABLE 1. SUMMARY OF MONITORING WELL FLUID GAUGING DATA
DONA ANA DAIRIES, DONA ANA COUNTY, NEW MEXICO**

Monitoring Well	Date Measured	Northing ^a	Easting ^a	Casing Elevation ^b	Depth to Water ^c	Ground Water Elevation ^b
624-09	1-May-2023	421471.18	1503801.31	3838.25	25.20	3813.05
	3-Feb-2023				23.87	3814.38
	2-Nov-2022				24.15	3814.10
	2-Aug-2022				23.47	3814.78
	3-May-2022				22.69	3815.56
	8-Feb-2022				21.87	3816.38
	4-Nov-2021				22.31	3815.94
	5-Aug-2021				22.43	3815.82
	4-May-2021				18.39	3819.86
	11-Feb-2021				17.42	3820.83
	3-Nov-2020				17.02	3821.23
	11-Aug-2020				17.20	3821.05
	11-May-2020				18.85	3819.40
	12-Feb-2020				17.35	3820.90
624-10	1-May-2023	421500.79	1507673.92	3839.50	25.71	3813.79
	3-Feb-2023				24.83	3814.67
	2-Nov-2022				24.02	3815.48
	2-Aug-2022				23.40	3816.10
	3-May-2022				22.89	3816.61
	8-Feb-2022				22.00	3817.50
	4-Nov-2021				21.06	3818.44
	5-Aug-2021				20.32	3819.18
	4-May-2021				22.80	3816.70
	11-Feb-2021				21.32	3818.18
	3-Nov-2020				21.22	3818.28
	11-Aug-2020				21.63	3817.87
	11-May-2020				22.98	3816.52
	12-Feb-2020				21.34	3818.16
624-11	2-May-2023	418501.93	1514076.76	3867.13	56.12	3811.01
	3-Feb-2023				55.27	3811.86
	2-Nov-2022				55.45	3811.68
	2-Aug-2022				55.10	3812.03
	3-May-2022				54.61	3812.52
	8-Feb-2022				54.20	3812.93
	4-Nov-2021				54.16	3812.97
	5-Aug-2021				54.17	3812.96
	4-May-2021				54.05	3813.08
	11-Feb-2021				53.34	3813.79
	3-Nov-2020				53.08	3814.05
	11-Aug-2020				53.52	3813.61
	11-May-2020				54.10	3813.03
	12-Feb-2020				53.35	3813.78

**TABLE 1. SUMMARY OF MONITORING WELL FLUID GAUGING DATA
DONA ANA DAIRIES, DONA ANA COUNTY, NEW MEXICO**

Monitoring Well	Date Measured	Northing ^a	Easting ^a	Casing Elevation ^b	Depth to Water ^c	Ground Water Elevation ^b
Gonzalez Dairy						
177-01	11-May-2020	417300.94	1512942.63	3834.27	18.60	3815.67
	5-Feb-2020				18.96	3815.31
	8-Nov-2019				17.55	3816.72
	1-Aug-2019				18.86	3815.41
	8-May-2019				18.60	3815.67
	19-Feb-2019				19.14	3815.13
	12-Nov-2018				18.40	3815.87
	6-Aug-2018				16.00	3818.27
	17-May-2018				19.18	3815.09
	5-Feb-2018				18.80	3815.47
	6-Nov-2017				18.32	3815.95
	8-Aug-2017				18.57	3815.70
	15-May-2017				19.76	3814.51
	7-Feb-2017				20.20	3814.07
	7-Nov-2016				19.25	3815.02
	15-Aug-2016				18.95	3815.32
	16-May-2016				20.48	3813.79
	9-Feb-2016				20.66	3813.61
	5-Nov-2015				20.22	3814.05
	13-Aug-2015				19.21	3815.06
	6-May-2015				19.40	3814.87
	6-Feb-2015				20.14	3814.13
	10-Nov-2014				19.12	3815.15
	13-Aug-2014				17.33	3816.94
	13-May-2014				18.53	3815.74
	12-Feb-2014				19.05	3815.22
	7-Nov-2013				17.97	3816.30
	6-Aug-2013				17.01	3817.26
	7-May-2013				17.81	3816.46
	7-Feb-2013				17.77	3816.50
	25-Oct-2012				15.91	3818.36
	30-Jul-2012				14.88	3819.39
	23-Apr-2012				16.32	3817.95
	26-Jan-2012				16.71	3817.56
	7-Dec-2011				16.36	3817.91
	19-Jul-2011				14.64	3819.63
	19-Apr-2011				14.84	3819.43
	17-Jan-2011				14.43	3819.84
	15-Sep-2010				13.30	3820.97
	23-Jun-2010				14.11	3820.16
22-Mar-2010	14.75	3819.52				
8-Dec-2009	14.68	3819.59				
28-Aug-2009	14.16	3820.11				
26-May-2009	14.35	3819.92				
10-Dec-2008	14.64	3819.63				
27-Sep-2008	14.21	3820.06				
10-Jun-2008	14.50	3819.77				
6-Feb-2008	15.06	3819.21				
13-Nov-2007	14.53	3819.74				
13-Sep-2007	14.03	3820.24				

**TABLE 1. SUMMARY OF MONITORING WELL FLUID GAUGING DATA
DONA ANA DAIRIES, DONA ANA COUNTY, NEW MEXICO**

Monitoring Well	Date Measured	Northing ^a	Easting ^a	Casing Elevation ^b	Depth to Water ^c	Ground Water Elevation ^b
177-02	11-May-2020	416738.21	1513246.51	3834.66	19.56	3815.10
	5-Feb-2020				19.40	3815.26
	8-Nov-2019				19.02	3815.64
	1-Aug-2019				19.38	3815.28
	8-May-2019				19.50	3815.16
	19-Feb-2019				19.58	3815.08
	12-Nov-2018				19.20	3815.46
	6-Aug-2018				17.05	3817.61
	17-May-2018				20.00	3814.66
	5-Feb-2018				19.45	3815.21
	6-Nov-2017				19.05	3815.61
	8-Aug-2017				19.17	3815.49
	15-May-2017				20.63	3814.03
	7-Feb-2017				20.91	3813.75
	7-Nov-2016				19.95	3814.71
	15-Aug-2016				19.50	3815.16
	16-May-2016				21.35	3813.31
	9-Feb-2016				21.33	3813.33
	5-Nov-2015				20.88	3813.78
	5-Aug-2015				19.91	3814.75
	6-May-2015				20.13	3814.53
	6-Feb-2015				20.75	3813.91
	10-Nov-2014				19.80	3814.86
	13-Aug-2014				18.21	3816.45
	13-May-2014				19.24	3815.42
	12-Feb-2014				19.72	3814.94
	7-Nov-2013				18.66	3816.00
	6-Aug-2013				18.30	3816.36
	7-May-2013				18.69	3815.97
	7-Feb-2013				18.50	3816.16
	25-Oct-2012				17.35	3817.31
	30-Jul-2012				17.80	3816.86
	24-Jan-2012				17.61	3817.05
	7-Dec-2011				16.92	3817.74
	19-Jul-2011				15.41	3819.25
	19-Apr-2011				15.47	3819.19
	17-Jan-2011				14.94	3819.72
	15-Sep-2010				14.23	3820.43
	23-Jun-2010				14.86	3819.80
	22-Mar-2010				15.59	3819.07
8-Dec-2009	15.29	3819.37				
28-Aug-2009	14.90	3819.76				
26-May-2009	15.09	3819.57				
10-Dec-2008	15.37	3819.29				
27-Sep-2008	14.95	3819.71				
10-Jun-2008	15.41	3819.25				
6-Feb-2008	15.74	3818.92				
13-Nov-2007	15.39	3819.27				
13-Sep-2007	14.72	3819.94				

**TABLE 1. SUMMARY OF MONITORING WELL FLUID GAUGING DATA
DONA ANA DAIRIES, DONA ANA COUNTY, NEW MEXICO**

Monitoring Well	Date Measured	Northing ^a	Easting ^a	Casing Elevation ^b	Depth to Water ^c	Ground Water Elevation ^b
177-03A	11-May-2020	416206.71	1513777.17	3835.75	21.76	3813.99
	5-Feb-2020				21.30	3814.45
	8-Nov-2019				20.86	3814.89
	1-Aug-2019				21.35	3814.40
	8-May-2019				21.70	3814.05
	19-Feb-2019				21.10	3814.65
	12-Nov-2018				21.20	3814.55
	6-Aug-2018				20.54	3815.21
	17-May-2018				21.90	3813.85
	5-Feb-2018				21.15	3814.60
	6-Nov-2017				20.89	3814.86
	8-Aug-2017				21.23	3814.52
	15-May-2017				22.55	3813.20
	7-Feb-2017				22.52	3813.23
	7-Nov-2016				21.97	3813.78
	15-Aug-2016				21.90	3813.85
	16-May-2016				23.26	3812.49
	9-Feb-2016				22.91	3812.84
	5-Nov-2015				22.68	3813.07
	5-Aug-2015				22.05	3813.70
	6-May-2015				22.26	3813.49
	6-Feb-2015				22.30	3813.45
	10-Nov-2014				21.61	3814.14
	13-Aug-2014				20.51	3815.24
	12-May-2014				21.60	3814.15
	12-Feb-2014				21.41	3814.34
	7-Nov-2013				20.29	3815.46
	6-Aug-2013				19.99	3815.76
	7-May-2013				20.53	3815.22
	7-Feb-2013				20.01	3815.74
25-Oct-2012	19.18	3816.57				
30-Jul-2012	18.24	3817.51				
24-Apr-2012	18.57	3817.18				
24-Jan-2012	18.63	3817.12				
13-Dec-2011	18.51	3817.24				

**TABLE 1. SUMMARY OF MONITORING WELL FLUID GAUGING DATA
DONA ANA DAIRIES, DONA ANA COUNTY, NEW MEXICO**

Monitoring Well	Date Measured	Northing ^a	Easting ^a	Casing Elevation ^b	Depth to Water ^c	Ground Water Elevation ^b
177-04	12-May-2020	416796.99	1513733.28	3840.33	25.90	3814.43
	5-Feb-2020				25.10	3815.23
	8-Nov-2019				24.89	3815.44
	1-Aug-2019				25.88	3814.45
	8-May-2019				25.81	3814.52
	19-Feb-2019				24.75	3815.58
	12-Nov-2018				24.35	3815.98
	6-Aug-2018				24.29	3816.04
	17-May-2018				26.17	3814.16
	5-Feb-2018				25.52	3814.81
	6-Nov-2017				25.30	3815.03
	16-Aug-2017				25.27	3815.06
	15-May-2017				26.80	3813.53
	7-Feb-2017				26.85	3813.48
	7-Nov-2016				26.21	3814.12
	15-Aug-2016				26.13	3814.20
	16-May-2016				27.45	3812.88
	9-Feb-2016				27.84	3812.49
	5-Nov-2015				26.89	3813.44
	5-Aug-2015				26.25	3814.08
	6-May-2015				26.49	3813.84
	6-Feb-2015				26.58	3813.75
	10-Nov-2014				25.75	3814.58
	13-Aug-2014				24.52	3815.81
	13-May-2014				25.46	3814.87
	12-Feb-2014				25.62	3814.71
	7-Nov-2013				24.75	3815.58
	6-Aug-2013				24.12	3816.21
	7-May-2013				24.67	3815.66
	7-Feb-2013				24.29	3816.04
	25-Oct-2012				23.49	3816.84
	30-Jul-2012				22.68	3817.65
	24-Apr-2012				23.36	3816.97
	24-Jan-2012				22.47	3817.86
	7-Dec-2011				22.97	3817.36
	19-Jul-2011				21.66	3818.67
	19-Apr-2011				21.41	3818.92
	17-Jan-2011				21.22	3819.11
	15-Sep-2010				20.36	3819.97
	23-Jun-2010				21.05	3819.28
22-Mar-2010	21.71	3818.62				
8-Dec-2009	21.14	3819.19				
28-Aug-2009	20.86	3819.47				
27-May-2009	21.13	3819.20				
10-Dec-2008	21.37	3818.96				
27-Sep-2008	20.86	3819.47				
10-Jun-2008	21.63	3818.70				
6-Feb-2008	21.59	3818.74				
13-Nov-2007	21.30	3819.03				
13-Sep-2007	20.84	3819.49				

**TABLE 1. SUMMARY OF MONITORING WELL FLUID GAUGING DATA
DONA ANA DAIRIES, DONA ANA COUNTY, NEW MEXICO**

Monitoring Well	Date Measured	Northing ^a	Easting ^a	Casing Elevation ^b	Depth to Water ^c	Ground Water Elevation ^b
177-05	12-May-2020	417302.42	1514116.55	3852.16	38.40	3813.76
	5-Feb-2020				38.02	3814.14
	8-Nov-2019				37.30	3814.86
	1-Aug-2019				38.59	3813.57
	8-May-2019				38.30	3813.86
	19-Feb-2019				38.20	3813.96
	12-Nov-2018				37.63	3814.53
	6-Aug-2018				37.30	3814.86
	17-May-2018				38.60	3813.56
	5-Feb-2018				37.80	3814.36
	6-Nov-2017				37.78	3814.38
	8-Aug-2017				38.26	3813.90
	15-May-2017				39.16	3813.00
	7-Feb-2017				38.95	3813.21
	7-Nov-2016				38.58	3813.58
	15-Aug-2016				38.84	3813.32
	16-May-2016				39.71	3812.45
	9-Feb-2016				39.25	3812.91
	5-Nov-2015				38.90	3813.26
	5-Aug-2015				38.65	3813.51
	6-May-2015				38.97	3813.19
	6-Feb-2015				38.48	3813.68
	10-Nov-2014				37.80	3814.36
	13-Aug-2014				36.70	3815.46
	13-May-2014				37.60	3814.56
	12-Feb-2014				37.51	3814.65
	6-Nov-2013				36.95	3815.21
	6-Aug-2013				36.02	3816.14
	7-May-2013				36.74	3815.42
	7-Feb-2013				36.21	3815.95
	25-Oct-2012				35.72	3816.44
	30-Jul-2012				36.39	3815.77
	24-Apr-2012				36.04	3816.12
	24-Jan-2012				35.02	3817.14
	7-Dec-2011				35.19	3816.97
	19-Jul-2011				34.07	3818.09
	19-Apr-2011				32.91	3819.25
	17-Jan-2011				33.72	3818.44
	15-Sep-2010				32.68	3819.48
	23-Jun-2010				33.59	3818.57
22-Mar-2010	34.10	3818.06				
8-Dec-2009	33.22	3818.94				
28-Aug-2009	32.95	3819.21				
26-May-2009	33.26	3818.90				
10-Dec-2008	33.60	3818.56				
27-Sep-2008	32.95	3819.21				
10-Jun-2008	33.96	3818.20				
6-Feb-2008	33.58	3818.58				
13-Nov-2007	33.27	3818.89				
13-Sep-2007	33.12	3819.04				

**TABLE 1. SUMMARY OF MONITORING WELL FLUID GAUGING DATA
DONA ANA DAIRIES, DONA ANA COUNTY, NEW MEXICO**

Monitoring Well	Date Measured	Northing ^a	Easting ^a	Casing Elevation ^b	Depth to Water ^c	Ground Water Elevation ^b
177-06	12-May-2020	417301.84	1514765.63	3866.02	Dry	
	5-Feb-2020				Dry	
	8-Nov-2019				Dry	
	1-Aug-2019				Dry	
	8-May-2019				Dry	
	19-Feb-2019				Dry	
	12-Nov-2018				Dry	
	6-Aug-2018				Dry	
	17-May-2018				Dry	
	5-Feb-2018				Dry	
	6-Nov-2017				Dry	
	8-Aug-2017				Dry	
	15-May-2017				Dry	
	7-Feb-2017				Dry	
	7-Nov-2016				Dry	
	15-Aug-2016				Dry	
	16-May-2016				Dry	
	9-Feb-2016				Dry	
	5-Nov-2015				Dry	
	5-Aug-2015				Dry	
	6-May-2015				Dry	
	6-Feb-2015				Dry	
	5-Nov-2014				Dry	
	13-Aug-2014				Dry	
	12-May-2014				Dry	
	12-Feb-2014				Dry	
	7-Nov-2013				51.65	3814.37
	6-Aug-2013				51.11	3814.91
	7-May-2013				51.50	3814.52
	7-Feb-2013				50.43	3815.59
	25-Oct-2012				50.81	3815.21
	30-Jul-2012				51.09	3814.93
	24-Apr-2012				Dry	
	24-Jan-2012				49.40	3816.62
	7-Dec-2011				49.85	3816.17
	19-Jul-2011				49.31	3816.71
	19-Apr-2011				48.92	3817.10
	17-Jan-2011				48.18	3817.84
	15-Sep-2010				47.64	3818.38
	23-Jun-2010				48.79	3817.23
	22-Mar-2010				49.12	3816.90
	8-Dec-2009				47.60	3818.42
28-Aug-2009	47.53	3818.49				
26-May-2009	48.03	3817.99				
10-Dec-2008	48.72	3817.30				
27-Sep-2008	47.52	3818.50				
10-Jun-2008	49.31	3816.71				
6-Feb-2008	48.00	3818.02				
13-Nov-2007	48.88	3817.14				
13-Sep-2007	48.84	3817.18				

**TABLE 1. SUMMARY OF MONITORING WELL FLUID GAUGING DATA
DONA ANA DAIRIES, DONA ANA COUNTY, NEW MEXICO**

Monitoring Well	Date Measured	Northing ^a	Easting ^a	Casing Elevation ^b	Depth to Water ^c	Ground Water Elevation ^b
177-07R	11-May-2020	415240.93	1515476.47	3858.91	47.26	3811.65
	5-Feb-2020				46.62	3812.29
	8-Nov-2019				46.39	3812.52
	1-Aug-2019				47.65	3811.26
	8-May-2019				47.23	3811.68
	19-Feb-2019				46.60	3812.31
	12-Nov-2018				46.70	3812.21
	6-Aug-2018				47.09	3811.82
	17-May-2018				47.00	3811.91
	5-Feb-2018				46.16	3812.75
	6-Nov-2017				46.62	3812.29
	8-Aug-2017				47.30	3811.61
	15-May-2017				47.68	3811.23
	7-Feb-2017				47.06	3811.85
	7-Nov-2016				47.50	3811.41
	15-Aug-2016				48.12	3810.79
	16-May-2016				48.09	3810.82
	9-Feb-2016				47.42	3811.49
	5-Nov-2015				47.57	3811.34
	5-Aug-2015				47.67	3811.24
	6-May-2015				47.35	3811.56
	6-Feb-2015				46.70	3812.21
	10-Nov-2014				46.53	3812.38
	13-Aug-2014				45.50	3813.41
	13-May-2014				46.66	3812.25
	12-Feb-2014				45.90	3813.01
	7-Nov-2013				45.50	3813.41
	6-Aug-2013				45.51	3813.40
	7-May-2013				45.22	3813.69
	7-Feb-2013				44.44	3814.47
25-Oct-2012	43.98	3814.93				
30-Jul-2012	43.60	3815.31				
24-Apr-2012	43.56	3815.35				
24-Jan-2012	43.08	3815.83				
7-Dec-2011	43.46	3815.45				
19-Jul-2011	42.91	3816.00				
19-Apr-2011	41.96	3816.95				
177-07	5-Nov-2014	415258.95	1515471.64	3859.96	Plugged and Abandoned	
	17-Jan-2011				Dry	
	15-Sep-2010				Dry	
	23-Jun-2010				Dry	
	22-Mar-2010				Dry	
	8-Dec-2009				Dry	
	10-Dec-2008				Dry	
	27-Sep-2008				Dry	
	10-Jun-2008				Dry	
	6-Feb-2008				Dry	
	13-Nov-2007				Dry	
	13-Sep-2007				Dry	

**TABLE 1. SUMMARY OF MONITORING WELL FLUID GAUGING DATA
DONA ANA DAIRIES, DONA ANA COUNTY, NEW MEXICO**

Monitoring Well	Date Measured	Northing ^a	Easting ^a	Casing Elevation ^b	Depth to Water ^c	Ground Water Elevation ^b
CENTRAL AREA						
Buena Vista Dairy II						
74-01	3-May-2023	405434.93	1519310.15	3841.01	39.12	3801.89
	6-Feb-2023				38.26	3802.75
	3-Nov-2022				38.40	3802.61
	4-Aug-2022				38.06	3802.95
	3-May-2022				37.51	3803.50
	9-Feb-2022				36.65	3804.36
	3-Nov-2021				37.60	3803.41
	6-Aug-2021				37.70	3803.31
	5-May-2021				36.69	3804.32
	11-Feb-2021				35.79	3805.22
	3-Nov-2020				36.49	3804.52
	11-Aug-2020				36.47	3804.54
	12-May-2020				36.35	3804.66
	5-Feb-2020				35.94	3805.07
	8-Nov-2019				36.71	3804.30
	1-Aug-2019				37.18	3803.83
	9-May-2019				37.05	3803.96
	20-Feb-2019				35.75	3805.26
	13-Nov-2018				36.24	3804.77
	7-Aug-2018				36.32	3804.69
	17-May-2018				36.35	3804.66
	6-Feb-2018				35.04	3805.97
	6-Nov-2017				35.65	3805.36
	7-Aug-2017				36.51	3804.50
	16-May-2017				37.00	3804.01
	7-Feb-2017				35.73	3805.28
	8-Nov-2016				36.17	3804.84
	16-Aug-2016				37.04	3803.97
	17-May-2016				37.32	3803.69
	9-Feb-2016				36.00	3805.01
	5-Nov-2015				36.63	3804.38
	6-Aug-2015				37.05	3803.96
	6-May-2015				37.38	3803.63
	5-Feb-2015				35.45	3805.56
	5-Nov-2014				36.66	3804.35
	13-Aug-2014				36.71	3804.30
	18-Jun-2014				37.09	3803.92
	12-Feb-2014				35.17	3805.84
	6-Nov-2013				35.77	3805.24
	6-Aug-2013				36.56	3804.45
7-May-2013	35.02	3805.99				
7-Feb-2013	33.64	3807.37				
25-Oct-2012	34.94	3806.07				
31-Jul-2012	34.53	3806.48				
24-Apr-2012	34.27	3806.74				
24-Jan-2012	33.36	3807.65				
8-Dec-2011	33.63	3807.38				
19-Jul-2011	33.31	3807.70				
20-Apr-2011	31.97	3809.04				
21-Jan-2011	32.23	3808.78				
16-Sep-2010	31.97	3809.04				
23-Jun-2010	32.08	3808.93				
22-Mar-2010	32.07	3808.94				
8-Dec-2009	31.45	3809.56				
28-Aug-2009	32.20	3808.81				
26-May-2009	32.20	3808.81				
10-Dec-2008	31.31	3809.70				
27-Sep-2008	31.64	3809.37				
10-Jun-2008	32.00	3809.01				
5-Feb-2008	31.66	3809.35				
14-Nov-2007	31.21	3809.80				
12-Sep-2007	31.63	3809.38				

**TABLE 1. SUMMARY OF MONITORING WELL FLUID GAUGING DATA
DONA ANA DAIRIES, DONA ANA COUNTY, NEW MEXICO**

Monitoring Well	Date Measured	Northing ^a	Easting ^a	Casing Elevation ^b	Depth to Water ^c	Ground Water Elevation ^b
74-02	3-May-2023	404574.08	1519035.52	3820.58	18.78	3801.80
	6-Feb-2023				18.38	3802.20
	3-Nov-2022				18.86	3801.72
	4-Aug-2022				18.74	3801.84
	7-May-2022				18.11	3802.47
	8-Feb-2022				17.23	3803.35
	3-Nov-2021				18.03	3802.55
	6-Aug-2021				18.20	3802.38
	5-May-2021				16.85	3803.73
	11-Feb-2021				15.99	3804.59
	3-Nov-2020				16.70	3803.88
	11-Aug-2020				17.28	3803.30
	12-May-2020				17.68	3802.90
	5-Feb-2020				16.10	3804.48
	8-Nov-2019				16.98	3803.60
	1-Aug-2019				17.57	3803.01
	9-May-2019				17.55	3803.03
	20-Feb-2019				16.00	3804.58
	13-Nov-2018				16.50	3804.08
	7-Aug-2018				16.61	3803.97
	17-May-2018				16.77	3803.81
	6-Feb-2018				15.16	3805.42
	6-Nov-2017				15.76	3804.82
	7-Aug-2017				16.87	3803.71
	16-May-2017				17.61	3802.97
	7-Feb-2017				16.01	3804.57
	8-Nov-2016				16.46	3804.12
	16-Aug-2016				17.59	3802.99
	17-May-2016				18.13	3802.45
	9-Feb-2016				16.40	3804.18
	5-Nov-2015				17.16	3803.42
	6-Aug-2015				17.89	3802.69
	6-May-2015				18.11	3802.47
	5-Feb-2015				16.00	3804.58
	5-Nov-2014				17.16	3803.42
	13-Aug-2014				17.50	3803.08
	18-Jun-2014				18.13	3802.45
	12-Feb-2014				15.75	3804.83
	6-Nov-2013				17.07	3803.51
	6-Aug-2013				17.55	3803.03
7-May-2013	16.22	3804.36				
7-Feb-2013	15.84	3804.74				
25-Oct-2012	16.02	3804.56				
31-Jul-2012	15.09	3805.49				
24-Apr-2012	14.30	3806.28				
24-Jan-2012	13.96	3806.62				
8-Dec-2011	15.49	3805.09				
19-Jul-2011	14.19	3806.39				
20-Apr-2011	12.45	3808.13				
17-Jan-2011	12.53	3808.05				
16-Sep-2010	12.45	3808.13				
23-Jun-2010	12.87	3807.71				
22-Mar-2010	12.72	3807.86				
8-Dec-2009	11.88	3808.70				
28-Aug-2009	12.53	3808.05				
26-May-2009	12.70	3807.88				
10-Dec-2008	11.65	3808.93				
27-Sep-2008	12.03	3808.55				
10-Jun-2008	12.39	3808.19				
5-Feb-2008	11.94	3808.64				
14-Nov-2007	11.52	3809.06				
12-Sep-2007	12.33	3808.25				

**TABLE 1. SUMMARY OF MONITORING WELL FLUID GAUGING DATA
DONA ANA DAIRIES, DONA ANA COUNTY, NEW MEXICO**

Monitoring Well	Date Measured	Northing ^a	Easting ^a	Casing Elevation ^b	Depth to Water ^c	Ground Water Elevation ^b
74-03	3-May-2023	407163.61	1516711.72	3823.36	19.10	3804.26
	6-Feb-2023				18.41	3804.95
	3-Nov-2022				18.40	3804.96
	4-Aug-2022				18.18	3805.18
	3-May-2022				17.60	3805.76
	8-Feb-2022				16.81	3806.55
	3-Nov-2021				17.25	3806.11
	6-Aug-2021				16.97	3806.39
	5-May-2021				16.20	3807.16
	11-Feb-2021				15.61	3807.75
	3-Nov-2020				15.67	3807.69
	11-Aug-2020				15.97	3807.39
	12-May-2020				16.51	3806.85
	5-Feb-2020				15.68	3807.68
	8-Nov-2019				15.77	3807.59
	1-Aug-2019				16.55	3806.81
	9-May-2019				16.39	3806.97
	20-Feb-2019				15.57	3807.79
	13-Nov-2018				15.68	3807.68
	7-Aug-2018				15.40	3807.96
	17-May-2018				15.50	3807.86
	6-Feb-2018				14.67	3808.69
	6-Nov-2017				14.71	3808.65
	7-Aug-2017				15.56	3807.80
	16-May-2017				16.38	3806.98
	7-Feb-2017				15.53	3807.83
	8-Nov-2016				15.57	3807.79
	16-Aug-2016				16.01	3807.35
	20-May-2016				16.57	3806.79
	9-Feb-2016				16.05	3807.31
	5-Nov-2015				16.10	3807.26
	5-Aug-2015				16.16	3807.20
	6-May-2015				16.29	3807.07
	5-Feb-2015				15.75	3807.61
	5-Nov-2014				15.67	3807.69
	13-Aug-2014				16.07	3807.29
	18-Jun-2014				16.73	3806.63
	12-Feb-2014				15.63	3807.73
	6-Nov-2013				15.53	3807.83
	6-Aug-2013				15.43	3807.93
7-May-2013	14.85	3808.51				
7-Feb-2013	13.93	3809.43				
25-Oct-2012	14.22	3809.14				
31-Jul-2012	14.17	3809.19				
24-Apr-2012	13.99	3809.37				
24-Jan-2012	13.60	3809.76				
8-Dec-2011	13.70	3809.66				
19-Jul-2011	13.17	3810.19				
20-Apr-2011	12.11	3811.25				
17-Jan-2011	12.63	3810.73				
16-Sep-2010	12.41	3810.95				
23-Jun-2010	12.72	3810.64				
22-Mar-2010	12.94	3810.42				
8-Dec-2009	12.88	3810.48				
28-Aug-2009	12.63	3810.73				
26-May-2009	12.94	3810.42				
10-Dec-2008	13.00	3810.36				
27-Sep-2008	12.94	3810.42				
10-Jun-2008	12.66	3810.7				
5-Feb-2008	12.94	3810.42				
14-Nov-2007	12.77	3810.59				
12-Sep-2007	12.53	3810.83				

**TABLE 1. SUMMARY OF MONITORING WELL FLUID GAUGING DATA
DONA ANA DAIRIES, DONA ANA COUNTY, NEW MEXICO**

Monitoring Well	Date Measured	Northing ^a	Easting ^a	Casing Elevation ^b	Depth to Water ^c	Ground Water Elevation ^b
74-04	3-May-2023	405488.65	1519864.48	3853.17	51.00	3802.17
	6-Feb-2023				50.20	3802.97
	3-Nov-2022				50.42	3802.75
	4-Aug-2022				50.36	3802.81
	3-May-2022				49.72	3803.45
	9-Feb-2022				48.85	3804.32
	3-Nov-2021				49.70	3803.47
	6-Aug-2021				49.62	3803.55
	5-May-2021				48.95	3804.22
	11-Feb-2021				48.09	3805.08
	3-Nov-2020				48.71	3804.46
	11-Aug-2020				48.93	3804.24
	12-May-2020				49.21	3803.96
	5-Feb-2020				48.21	3804.96
	8-Nov-2019				48.95	3804.22
	1-Aug-2019				49.30	3803.87
	9-May-2019				49.00	3804.17
	20-Feb-2019				47.95	3805.22
	13-Nov-2018				48.45	3804.72
	7-Aug-2018				48.48	3804.69
	17-May-2018				48.37	3804.80
	6-Feb-2017				47.35	3805.82
	6-Nov-2017				47.95	3805.22
	7-Aug-2017				48.78	3804.39
	16-May-2017				49.00	3804.17
	7-Feb-2017				47.97	3805.20
	8-Nov-2016				48.44	3804.73
	16-Aug-2016				49.27	3803.90
	17-May-2016				NM	NM
	9-Feb-2016				48.35	3804.82
	5-Nov-2015				49.03	3804.14
	6-Aug-2015				49.21	3803.96
	6-May-2015				49.44	3803.73
	5-Feb-2015				47.86	3805.31
	5-Nov-2014				49.58	3803.59
	13-Aug-2014				49.12	3804.05
	18-Jun-2014				49.35	3803.82
	12-Feb-2014				47.75	3805.42
	6-Nov-2013				48.06	3805.11
	6-Aug-2013				48.55	3804.62
	7-May-2013				47.45	3805.72
	7-Feb-2013				46.31	3806.86
25-Oct-2012	46.96	3806.21				
31-Jul-2012	47.16	3806.01				
24-Apr-2012	47.05	3806.12				
24-Jan-2012	45.78	3807.39				
8-Dec-2011	45.98	3807.19				
19-Jul-2011	45.61	3807.56				
20-Apr-2011	44.19	3808.98				
17-Jan-2011	44.02	3809.15				
16-Sep-2010	44.19	3808.98				
23-Jun-2010	44.26	3808.91				
22-Mar-2010	44.25	3808.92				
8-Dec-2009	43.86	3809.31				
28-Aug-2009	44.49	3808.68				
26-May-2009	44.56	3808.61				
10-Dec-2008	43.70	3809.47				
27-Sep-2008	43.99	3809.18				
10-Jun-2008	44.40	3808.77				
5-Feb-2008	43.41	3809.76				

**TABLE 1. SUMMARY OF MONITORING WELL FLUID GAUGING DATA
DONA ANA DAIRIES, DONA ANA COUNTY, NEW MEXICO**

Monitoring Well	Date Measured	Northing ^a	Easting ^a	Casing Elevation ^b	Depth to Water ^c	Ground Water Elevation ^b
74-05	3-May-2023	404747.71	1519885.3	3845.35	43.23	3802.12
	6-Feb-2023				42.80	3802.55
	3-Nov-2022				43.25	3802.10
	4-Aug-2022				43.00	3802.35
	3-May-2022				42.39	3802.96
	9-Feb-2022				41.68	3803.67
	3-Nov-2021				42.40	3802.95
	6-Aug-2021				42.50	3802.85
	5-May-2021				41.60	3803.75
	11-Feb-2021				40.73	3804.62
	3-Nov-2020				41.40	3803.95
	11-Aug-2020				40.92	3804.43
	12-May-2020				41.83	3803.52
	5-Feb-2020				40.90	3804.45
	8-Nov-2019				41.68	3803.67
	1-Aug-2019				42.12	3803.23
	9-May-2019				41.87	3803.48
	20-Feb-2019				40.65	3804.70
	13-Nov-2018				41.18	3804.17
	7-Aug-2018				41.22	3804.13
	17-May-2018				41.19	3804.16
	6-Feb-2018				39.97	3805.38
	6-Nov-2017				40.59	3804.76
	7-Aug-2017				41.59	3803.76
	16-May-2017				41.93	3803.42
	7-Feb-2017				40.74	3804.61
	8-Nov-2016				41.23	3804.12
	16-Aug-2016				42.23	3803.12
	17-May-2016				42.62	3802.73
	9-Feb-2016				41.19	3804.16
	5-Nov-2015				42.00	3803.35
	6-Aug-2015				42.35	3803.00
	6-May-2015				41.63	3803.72
	5-Feb-2015				40.78	3804.57
	5-Nov-2014				41.99	3803.36
	13-Aug-2014				42.28	3803.07
	18-Jun-2014				42.73	3802.62
	12-Feb-2014				40.76	3804.59
	6-Nov-2013				41.17	3804.18
	6-Aug-2013				41.80	3803.55
7-May-2013	40.98	3804.37				
7-Feb-2013	39.40	3805.95				
25-Oct-2012	40.33	3805.02				
31-Jul-2012	40.19	3805.16				
24-Apr-2012	40.05	3805.30				
24-Jan-2012	38.78	3806.57				
8-Dec-2011	39.18	3806.17				
19-Jul-2011	38.84	3806.51				
20-Apr-2011	37.99	3807.36				
17-Jan-2011	36.96	3808.39				
16-Sep-2010	37.00	3808.35				
23-Jun-2010	37.44	3807.91				
22-Mar-2010	37.23	3808.12				
8-Dec-2009	36.74	3808.61				
28-Aug-2009	37.32	3808.03				
26-May-2009	37.47	3807.88				
10-Dec-2008	36.53	3808.82				
27-Sep-2008	36.88	3808.47				
10-Jun-2008	37.39	3807.96				
5-Feb-2008	36.77	3808.58				

**TABLE 1. SUMMARY OF MONITORING WELL FLUID GAUGING DATA
DONA ANA DAIRIES, DONA ANA COUNTY, NEW MEXICO**

Monitoring Well	Date Measured	Northing ^a	Easting ^a	Casing Elevation ^b	Depth to Water ^c	Ground Water Elevation ^b
River Valley Dairy						
167-01	6-Feb-2018	402518.37	1518459.71	3818.94	14.31	3804.63
	7-Nov-2017				14.48	3804.46
	7-Aug-2017				15.27	3803.67
	16-May-2017				17.65	3801.29
	7-Feb-2017				15.31	3803.63
	8-Nov-2016				15.63	3803.31
	30-Aug-2016				15.90	3803.04
	20-May-2016				18.97	3799.97
	10-Feb-2016				16.37	3802.57
	5-Nov-2015				17.30	3801.64
	6-Aug-2015				17.91	3801.03
	6-May-2015				18.04	3800.90
	5-Feb-2015				16.18	3802.76
	10-Nov-2014				17.86	3801.08
	13-Aug-2014				18.49	3800.45
	18-Jun-2014				19.77	3799.17
	12-Feb-2014				16.81	3802.13
	6-Nov-2013				18.82	3800.12
	6-Aug-2013				19.11	3799.83
	7-May-2013				18.43	3800.51
	7-Feb-2013				17.02	3801.92
	25-Oct-2012				17.23	3801.71
	31-Jul-2012				16.91	3802.03
	24-Apr-2012				16.01	3802.93
	24-Jan-2012				14.60	3804.34
	8-Dec-2011				15.06	3803.88
	19-Jul-2011				16.81	3802.13
	25-Apr-2011				14.51	3804.43
	17-Jan-2011				12.33	3806.61
	15-Sep-2010				12.19	3806.75
	25-Jun-2010				13.31	3805.63
	22-Mar-2010				13.46	3805.48
	8-Dec-2009				12.11	3806.83
28-Aug-2009	11.99	3806.95				
26-May-2009	12.43	3806.51				
10-Dec-2008	12.13	3806.81				
27-Sep-2008	12.09	3806.85				
10-Jun-2008	12.95	3805.99				
5-Feb-2008	12.62	3806.32				
14-Nov-2007	12.68	3806.26				

**TABLE 1. SUMMARY OF MONITORING WELL FLUID GAUGING DATA
DONA ANA DAIRIES, DONA ANA COUNTY, NEW MEXICO**

Monitoring Well	Date Measured	Northing ^a	Easting ^a	Casing Elevation ^b	Depth to Water ^c	Ground Water Elevation ^b
167-01A	6-Feb-2018	402518.18	1518936.72	3818.88	14.50	3804.38
	7-Nov-2017				14.82	3804.06
	7-Aug-2017				15.79	3803.09
	16-May-2017				17.62	3801.26
	7-Feb-2017				15.45	3803.43
	8-Nov-2016				15.89	3802.99
	30-Aug-2016				16.41	3802.47
	16-May-2016				18.81	3800.07
	10-Feb-2016				16.50	3802.38
	5-Nov-2015				17.51	3801.37
	6-Aug-2015				18.10	3800.78
	6-May-2015				18.84	3800.04
	5-Feb-2015				16.32	3802.56
	5-Nov-2014				17.35	3801.53
	13-Aug-2014				18.34	3800.54
	18-Jun-2014				19.65	3799.23
	12-Feb-2014				16.79	3802.09
	6-Nov-2013				18.19	3800.69
	6-Aug-2013				18.54	3800.34
	7-May-2013				18.22	3800.66
	7-Feb-2013				17.45	3801.43
	25-Oct-2012				17.38	3801.50
	31-Jul-2012				17.08	3801.80
	24-Apr-2012				16.29	3802.59
	24-Jan-2012				14.59	3804.29
	13-Dec-2011				15.13	3803.75
	19-Jul-2011				16.04	3802.84
	25-Apr-2011				14.13	3804.75
	17-Jan-2011				12.38	3806.50
	15-Sep-2010				12.21	3806.67
	22-Jun-2010				13.74	3805.14
	22-Mar-2010				13.22	3805.66
8-Dec-2009	12.17	3806.71				
28-Aug-2009	12.23	3806.65				
26-May-2009	12.62	3806.26				
10-Dec-2008	12.03	3806.85				
27-Sep-2008	12.18	3806.70				
10-Jun-2008	13.16	3805.72				

**TABLE 1. SUMMARY OF MONITORING WELL FLUID GAUGING DATA
DONA ANA DAIRIES, DONA ANA COUNTY, NEW MEXICO**

Monitoring Well	Date Measured	Northing ^a	Easting ^a	Casing Elevation ^b	Depth to Water ^c	Ground Water Elevation ^b
167-02	6-Feb-2018	402498.3	1519354.81	3819.64	15.80	3803.84
	7-Nov-2017				16.18	3803.46
	7-Aug-2017				16.75	3802.89
	16-May-2017				18.97	3800.67
	7-Feb-2017				16.90	3802.74
	8-Nov-2016				17.22	3802.42
	30-Aug-2016				17.38	3802.26
	16-May-2016				20.44	3799.20
	10-Feb-2016				17.88	3801.76
	5-Nov-2015				18.70	3800.94
	6-Aug-2015				18.98	3800.66
	12-May-2015				20.88	3798.76
	6-May-2015				21.50	3798.14
	5-Feb-2015				17.25	3802.39
	10-Nov-2014				Dry	
	13-Aug-2014				19.35	3800.29
	18-Jun-2014				Dry	
	12-Feb-2014				17.94	3801.70
	6-Nov-2013				Dry	
	6-Aug-2013				Dry	
	7-May-2013				Dry	
	7-Feb-2013				Dry	
	25-Oct-2012				Dry	
	31-Jul-2012				Dry	
	24-Apr-2012				Dry	
	24-Jan-2012				15.84	3803.80
	8-Dec-2011				15.92	3803.72
	19-Jul-2011				Dry	
	25-Apr-2011				13.48	3806.16
	17-Jan-2011				13.49	3806.15
	15-Sep-2010				13.68	3805.96
	22-Jun-2010				15.23	3804.41
	22-Mar-2010				14.69	3804.95
	8-Dec-2009				13.32	3806.32
	28-Aug-2009				13.65	3805.99
	26-May-2009				13.86	3805.78
	10-Dec-2008				13.43	3806.21
	27-Sep-2008				13.71	3805.93
	10-Jun-2008				14.70	3804.94
	5-Feb-2008				13.54	3806.10
14-Nov-2007	13.65	3805.99				
11-Sep-2007	13.98	3805.66				

**TABLE 1. SUMMARY OF MONITORING WELL FLUID GAUGING DATA
DONA ANA DAIRIES, DONA ANA COUNTY, NEW MEXICO**

Monitoring Well	Date Measured	Northing ^a	Easting ^a	Casing Elevation ^b	Depth to Water ^c	Ground Water Elevation ^b
167-03	6-Feb-2018	402981.73	1519415.73	3825.66	21.15	3804.51
	7-Nov-2017				21.68	3803.98
	7-Aug-2017				22.76	3802.90
	16-May-2017				24.00	3801.66
	7-Feb-2017				22.09	3803.57
	8-Nov-2016				22.55	3803.11
	30-Aug-2016				23.22	3802.44
	16-May-2016				25.07	3800.59
	10-Feb-2016				22.98	3802.68
	5-Nov-2015				23.96	3801.70
	6-Aug-2015				24.52	3801.14
	6-May-2015				24.58	3801.08
	5-Feb-2015				22.70	3802.96
	10-Nov-2014				24.45	3801.21
	13-Aug-2014				24.81	3800.85
	18-Jun-2014				25.84	3799.82
	12-Feb-2014				23.04	3802.62
	6-Nov-2013				24.79	3800.87
	6-Aug-2013				25.27	3800.39
	7-May-2013				22.99	3802.67
	7-Feb-2013				22.06	3803.60
	25-Oct-2012				23.49	3802.17
	31-Jul-2012				22.63	3803.03
	24-Apr-2012				21.97	3803.69
	24-Jan-2012				20.94	3804.72
	8-Dec-2011				21.73	3803.93
	19-Jul-2011				23.22	3802.44
	25-Apr-2011				18.78	3806.88
	17-Jan-2011				18.86	3806.80
	15-Sep-2010				18.81	3806.85
	22-Jun-2010				19.90	3805.76
	22-Mar-2010				19.71	3805.95
8-Dec-2009	18.62	3807.04				
28-Aug-2009	18.90	3806.76				
27-May-2009	19.26	3806.40				
10-Dec-2008	18.41	3807.25				
27-Sep-2008	18.72	3806.94				
10-Jun-2008	19.82	3805.84				
5-Feb-2008	18.64	3807.02				
14-Nov-2007	18.55	3807.11				
11-Sep-2007	19.02	3806.64				

**TABLE 1. SUMMARY OF MONITORING WELL FLUID GAUGING DATA
DONA ANA DAIRIES, DONA ANA COUNTY, NEW MEXICO**

Monitoring Well	Date Measured	Northing ^a	Easting ^a	Casing Elevation ^b	Depth to Water ^c	Ground Water Elevation ^b
167-04	6-Feb-2018	402032.19	1519884.6	3827.60	23.45	3804.15
	7-Nov-2017				23.84	3803.76
	7-Aug-2017				24.68	3802.92
	16-May-2017				26.21	3801.39
	7-Feb-2017				24.34	3803.26
	8-Nov-2016				24.87	3802.73
	30-Aug-2016				25.30	3802.30
	16-May-2016				27.10	3800.50
	10-Feb-2016				25.37	3802.23
	5-Nov-2015				26.23	3801.37
	6-Aug-2015				26.73	3800.87
	6-May-2015				27.07	3800.53
	5-Feb-2015				25.22	3802.38
	10-Nov-2014				26.18	3801.42
	13-Aug-2014				26.91	3800.69
	18-Jun-2014				27.94	3799.66
	12-Feb-2014				25.42	3802.18
	6-Nov-2013				26.38	3801.22
	6-Aug-2013				26.70	3800.90
	7-May-2013				25.59	3802.01
	7-Feb-2013				24.84	3802.76
	25-Oct-2012				25.60	3802.00
	31-Jul-2012				25.19	3802.41
	24-Apr-2012				25.05	3802.55
	24-Jan-2012				23.36	3804.24
	8-Dec-2011				24.01	3803.59
	19-Jul-2011				24.36	3803.24
	25-Apr-2011				21.23	3806.37
	17-Jan-2011				21.18	3806.42
	15-Sep-2010				Well Damaged	
	22-Jun-2010					
	22-Mar-2010				Well Damaged	
	8-Dec-2009				Well Damaged	
28-Aug-2009	21.57	3806.03				
26-May-2009	21.60	3806.00				
10-Dec-2008	21.01	3806.59				
27-Sep-2008	21.01	3806.59				
10-Jun-2008	22.20	3805.40				
5-Feb-2008	21.51	3806.09				
14-Nov-2007	21.44	3806.16				
11-Sep-2007	21.68	3805.92				

**TABLE 1. SUMMARY OF MONITORING WELL FLUID GAUGING DATA
DONA ANA DAIRIES, DONA ANA COUNTY, NEW MEXICO**

Monitoring Well	Date Measured	Northing ^a	Easting ^a	Casing Elevation ^b	Depth to Water ^c	Ground Water Elevation ^b
167-05	6-Feb-2018	397947.44	1520446.03	3815.44	14.61	3800.83
	7-Nov-2017				14.59	3800.85
	7-Aug-2017				14.94	3800.50
	16-May-2017				16.91	3798.53
	7-Feb-2017				15.40	3800.04
	8-Nov-2016				15.97	3799.47
	30-Aug-2016				15.43	3800.01
	16-May-2016				17.69	3797.75
	10-Feb-2016				16.42	3799.02
	5-Nov-2015				16.96	3798.48
	6-Aug-2015				16.12	3799.32
	6-May-2015				17.98	3797.46
	5-Feb-2015				16.13	3799.31
	10-Nov-2014				16.84	3798.60
	13-Aug-2014				15.94	3799.50
	18-Jun-2014				17.19	3798.25
	12-Feb-2014				15.73	3799.71
	6-Nov-2013				15.75	3799.69
	6-Aug-2013				16.03	3799.41
	7-May-2013				15.42	3800.02
	7-Feb-2013				14.96	3800.48
	25-Oct-2012				15.74	3799.70
	31-Jul-2012				15.60	3799.84
	24-Apr-2012				14.99	3800.45
	30-Jan-2012				13.86	3801.58
	13-Dec-2011				14.10	3801.34
	19-Jul-2011				13.69	3801.75
	19-Apr-2011				12.97	3802.47
	17-Jan-2011				11.90	3803.54
	15-Sep-2010				11.52	3803.92
	25-Jun-2010				12.43	3803.01
	22-Mar-2010				12.22	3803.22
8-Dec-2009	11.96	3803.48				
28-Aug-2009	11.63	3803.81				
26-May-2009	11.45	3803.99				
10-Dec-2008	11.54	3803.90				
27-Sep-2008	11.20	3804.24				
10-Jun-2008	12.65	3802.79				
5-Feb-2008	12.36	3803.08				
14-Nov-2007	12.77	3802.67				
11-Sep-2007	12.91	3802.53				

**TABLE 1. SUMMARY OF MONITORING WELL FLUID GAUGING DATA
DONA ANA DAIRIES, DONA ANA COUNTY, NEW MEXICO**

Monitoring Well	Date Measured	Northing ^a	Easting ^a	Casing Elevation ^b	Depth to Water ^c	Ground Water Elevation ^b
167-06	6-Feb-2018	404479.35	1519603.88	3834.84	29.52	3805.32
	7-Nov-2017				30.11	3804.73
	7-Aug-2017				31.20	3803.64
	16-May-2017				31.71	3803.13
	7-Feb-2017				30.35	3804.49
	8-Nov-2016				30.83	3804.01
	30-Aug-2016				31.55	3803.29
	16-May-2016				32.40	3802.44
	10-Feb-2016				30.83	3804.01
	5-Nov-2015				31.73	3803.11
	6-Aug-2015				32.13	3802.71
	6-May-2015				32.36	3802.48
	5-Feb-2015				30.44	3804.40
	10-Nov-2014				31.33	3803.51
	13-Aug-2014				32.08	3802.76
	18-Jun-2014				32.63	3802.21
	12-Feb-2014				30.42	3804.42
	6-Nov-2013				30.95	3803.89
	6-Aug-2013				31.73	3803.11
	7-May-2013				30.83	3804.01
	7-Feb-2013				30.00	3804.84
	25-Oct-2012				30.12	3804.72
	31-Jul-2012				30.29	3804.55
	24-Apr-2012				29.84	3805.00
	24-Jan-2012				28.48	3806.36
	8-Dec-2011				29.10	3805.74
	19-Jul-2011				28.75	3806.09
	25-Apr-2011				26.71	3808.13
	17-Jan-2011				26.73	3808.11
	15-Sep-2010				26.70	3808.14
	22-Jun-2010				27.17	3807.67
	22-Mar-2010				27.02	3807.82
8-Dec-2009	26.40	3808.44				
28-Aug-2009	26.96	3807.88				
26-May-2009	27.15	3807.69				
10-Dec-2008	26.18	3808.66				
27-Sep-2008	26.54	3808.30				
10-Jun-2008	27.10	3807.74				
5-Feb-2008	26.46	3808.38				
14-Nov-2007	26.60	3808.24				
11-Sep-2007	26.74	3808.10				

**TABLE 1. SUMMARY OF MONITORING WELL FLUID GAUGING DATA
DONA ANA DAIRIES, DONA ANA COUNTY, NEW MEXICO**

Monitoring Well	Date Measured	Northing ^a	Easting ^a	Casing Elevation ^b	Depth to Water ^c	Ground Water Elevation ^b
167-07	6-Feb-2018	402562.23	1518480.34	3819.08	14.23	3804.85
	7-Nov-2017				14.47	3804.61
	7-Aug-2017				15.41	3803.67
	16-May-2017				17.45	3801.63
	7-Feb-2017				15.18	3803.90
	8-Nov-2016				15.51	3803.57
	16-May-2016				16.20	3802.88
	16-May-2016				18.79	3800.29
	10-Feb-2016				16.25	3802.83
	5-Nov-2015				17.40	3801.68
	6-Aug-2015				18.28	3800.80
	6-May-2015				18.80	3800.28
	5-Feb-2015				16.26	3802.82
	10-Nov-2014				17.11	3801.97
	13-Aug-2014				18.47	3800.61
	18-Jun-2014				19.76	3799.32
	12-Feb-2014				16.88	3802.20
	6-Nov-2013				17.82	3801.26
	6-Aug-2013				18.25	3800.83
	7-May-2013				16.14	3802.94
	7-Feb-2013				15.84	3803.24
	25-Oct-2012				16.30	3802.78
	31-Jul-2012				16.09	3802.99
	24-Apr-2012				15.84	3803.24
	24-Jan-2012				14.54	3804.54
	8-Dec-2011				15.45	3803.63
	25-Jul-2011				15.39	3803.69
	25-Apr-2011				14.95	3804.13
	17-Jan-2011				12.39	3806.69
	15-Sep-2010				11.98	3807.10
	22-Jun-2010				12.94	3806.14
	22-Mar-2010				13.03	3806.05
8-Dec-2009	12.18	3806.90				
28-Aug-2009	12.06	3807.02				
26-May-2009	12.56	3806.52				
10-Dec-2008	12.24	3806.84				
27-Sep-2008	12.20	3806.88				
10-Jun-2008	13.00	3806.08				

**TABLE 1. SUMMARY OF MONITORING WELL FLUID GAUGING DATA
DONA ANA DAIRIES, DONA ANA COUNTY, NEW MEXICO**

Monitoring Well	Date Measured	Northing ^a	Easting ^a	Casing Elevation ^b	Depth to Water ^c	Ground Water Elevation ^b
167-08	6-Feb-2018	399352.96	1519889.65	3817.96	14.48	3803.48
	7-Nov-2017				14.29	3803.67
	7-Aug-2017				14.42	3803.54
	16-May-2017				17.05	3800.91
	7-Feb-2017				15.22	3802.74
	8-Nov-2016				15.81	3802.15
	16-May-2016				17.68	3800.28
	10-Feb-2016				16.33	3801.63
	23-Nov-2015				16.95	3801.01
	6-Aug-2015				18.40	3799.56
	6-May-2015				19.56	3798.40
	5-Feb-2015				17.78	3800.18
	5-Nov-2014				18.31	3799.65
	13-Aug-2014				18.46	3799.50
	18-Jun-2014				19.71	3798.25
	12-Feb-2014				17.65	3800.31
	6-Nov-2013				17.68	3800.28
	6-Aug-2013				18.07	3799.89
	7-May-2013				16.99	3800.97
	7-Feb-2013				16.73	3801.23
	25-Oct-2012				17.72	3800.24
	31-Jul-2012				17.60	3800.36
	24-Apr-2012				16.71	3801.25
	24-Jan-2012				15.25	3802.71
	8-Dec-2011				15.52	3802.44
	19-Jul-2011				15.59	3802.37
	19-Apr-2011				13.95	3804.01
	17-Jan-2011				13.42	3804.54
	15-Sep-2010				12.92	3805.04
	25-Jun-2010				14.69	3803.27
22-Mar-2010	13.73	3804.23				
8-Dec-2009	13.46	3804.50				
28-Aug-2009	13.23	3804.73				
26-May-2009	12.87	3805.09				
10-Dec-2008	13.42	3804.54				
27-Sep-2008	NM	NM				
10-Jun-2008	14.02	3803.94				

**TABLE 1. SUMMARY OF MONITORING WELL FLUID GAUGING DATA
DONA ANA DAIRIES, DONA ANA COUNTY, NEW MEXICO**

Monitoring Well	Date Measured	Northing ^a	Easting ^a	Casing Elevation ^b	Depth to Water ^c	Ground Water Elevation ^b
167-09	6-Feb-2018	398473.95	1519259.34	3817.00	14.95	3802.05
	7-Nov-2017				14.15	3802.85
	7-Aug-2017				14.96	3802.04
	16-May-2017				17.10	3799.90
	7-Feb-2017				15.70	3801.30
	8-Nov-2016				15.86	3801.14
	30-Aug-2016				15.33	3801.67
	16-May-2016				17.64	3799.36
	10-Feb-2016				16.66	3800.34
	5-Nov-2015				17.28	3799.72
	6-Aug-2015				16.30	3800.70
	6-May-2015				17.96	3799.04
	5-Feb-2015				16.81	3800.19
	5-Nov-2014				16.78	3800.22
	13-Aug-2014				16.92	3800.08
	18-Jun-2014				17.69	3799.31
	12-Feb-2014				16.38	3800.62
	6-Nov-2013				15.91	3801.09
	6-Aug-2013				16.22	3800.78
	7-May-2013				16.09	3800.91
	7-Feb-2013				15.36	3801.64
	25-Oct-2012				15.31	3801.69
	31-Jul-2012				15.04	3801.96
	24-Apr-2012				15.12	3801.88
	24-Jan-2012				14.60	3802.40
	8-Dec-2011				14.42	3802.58
	19-Jul-2011				13.17	3803.83
	19-Apr-2011				12.78	3804.22
	17-Jan-2011				12.70	3804.30
	15-Sep-2010				11.95	3805.05
25-Jun-2010	13.01	3803.99				
22-Mar-2010	12.88	3804.12				
8-Dec-2009	12.82	3804.18				
28-Aug-2009	12.43	3804.57				
26-May-2009	12.44	3804.56				
10-Dec-2008	12.78	3804.22				
27-Sep-2008	12.07	3804.93				
10-Jun-2008	12.94	3804.06				

**TABLE 1. SUMMARY OF MONITORING WELL FLUID GAUGING DATA
DONA ANA DAIRIES, DONA ANA COUNTY, NEW MEXICO**

Monitoring Well	Date Measured	Northing ^a	Easting ^a	Casing Elevation ^b	Depth to Water ^c	Ground Water Elevation ^b
Big Sky Dairy						
833-01	5-Aug-2017	399617.23	1521136.33	3839.55	Plugged and Abandoned	
	16-May-2017				Dry	
	7-Feb-2017				Dry	
	8-Nov-2016				Dry	
	16-Aug-2016				Dry	
	17-May-2016				Dry	
	10-Feb-2016				Dry	
	5-Nov-2015				Dry	
	17-Aug-2015				Dry	
	6-May-2015				Dry	
	6-Feb-2015				Dry	
	5-Nov-2014				Dry	
	12-Aug-2014				Dry	
	18-Jun-2014				Dry	
	12-Feb-2014				Dry	
	6-Nov-2013				Dry	
	6-Aug-2013				Dry	
	8-May-2013				Dry	
	7-Feb-2013				Dry	
	25-Oct-2012				Dry	
	1-Aug-2012				Dry	
	24-Apr-2012				Dry	
	24-Jan-2012				Dry	
	8-Dec-2011				Dry	
	18-Jul-2011				Dry	
	19-Apr-2001				35.44	3804.11
	17-Jan-2011				35.20	3804.35
	14-Sep-2010				34.76	3804.79
	22-Jun-2010				36.08	3803.47
	22-Mar-2010				35.49	3804.06
	8-Dec-2009				35.25	3804.30
	28-Aug-2009				35.25	3804.30
26-May-2009	34.69	3804.86				
10-Dec-2008	34.99	3804.56				
28-Sep-2008	34.58	3804.97				
10-Jun-2008	36.13	3803.42				
5-Feb-2008	35.51	3804.04				
14-Nov-2007	35.70	3803.85				
12-Sep-2007	35.79	3803.76				

**TABLE 1. SUMMARY OF MONITORING WELL FLUID GAUGING DATA
DONA ANA DAIRIES, DONA ANA COUNTY, NEW MEXICO**

Monitoring Well	Date Measured	Northing ^a	Easting ^a	Casing Elevation ^b	Depth to Water ^c	Ground Water Elevation ^b
833-02	3-May-2023	401200.32	1520639.92	3836.04	36.40	3799.64
	6-Feb-2023				35.79	3800.25
	4-Nov-2022				36.46	3799.58
	4-Aug-2022				36.39	3799.65
	4-May-2022				35.60	3800.44
	9-Feb-2022				34.64	3801.40
	3-Nov-2021				35.41	3800.63
	6-Aug-2021				35.89	3800.15
	5-May-2021				34.56	3801.48
	12-Feb-2021				33.94	3802.10
	4-Nov-2020				34.15	3801.89
	11-Aug-2020				34.18	3801.86
	12-May-2020				33.99	3802.05
	6-Feb-2020				33.48	3802.56
	8-Nov-2019				33.16	3802.88
	5-Aug-2019				35.51	3800.53
	9-May-2019				35.18	3800.86
	20-Feb-2019				33.90	3802.14
	13-Nov-2018				34.43	3801.61
	7-Aug-2018				34.42	3801.62
	14-May-2018				34.05	3801.99
	6-Feb-2018				33.45	3802.59
	7-Nov-2017				33.19	3802.85
	9-Aug-2017				33.78	3802.26
	16-May-2017				35.28	3800.76
	7-Feb-2017				33.80	3802.24
	8-Nov-2016				34.24	3801.80
	16-Aug-2016				34.85	3801.19
	17-May-2016				35.69	3800.35
	10-Feb-2016				34.79	3801.25
	5-Nov-2015				35.48	3800.56
	6-Aug-2015				35.90	3800.14
	6-May-2015				37.04	3799.00
	6-Feb-2015				35.20	3800.84
	5-Nov-2014				35.48	3800.56
	12-Aug-2014				36.02	3800.02
	18-Jun-2014				36.72	3799.32
	12-Feb-2014				34.61	3801.43
	6-Nov-2013				34.80	3801.24
	6-Aug-2013				35.44	3800.60
8-May-2013	35.13	3800.91				
7-Feb-2013	33.42	3802.62				
25-Oct-2012	34.61	3801.43				
1-Aug-2012	34.90	3801.14				
24-Apr-2012	33.49	3802.55				
24-Jan-2012	34.01	3802.03				
8-Dec-2011	33.08	3802.96				
18-Jul-2011	32.92	3803.12				
19-Apr-2011	31.92	3804.12				
17-Jan-2011	30.43	3805.61				
14-Sep-2010	30.34	3805.70				
22-Jun-2010	31.37	3804.67				
22-Mar-2010	30.87	3805.17				
8-Dec-2009	30.40	3805.64				
28-Aug-2009	30.58	3805.46				
26-May-2009	30.24	3805.80				
10-Dec-2008	30.13	3805.91				
28-Sep-2008	29.80	3806.24				
10-Jun-2008	31.21	3804.83				
5-Feb-2008	30.63	3805.41				
14-Nov-2007	30.60	3805.44				
12-Sep-2007	30.63	3805.41				

**TABLE 1. SUMMARY OF MONITORING WELL FLUID GAUGING DATA
DONA ANA DAIRIES, DONA ANA COUNTY, NEW MEXICO**

Monitoring Well	Date Measured	Northing ^a	Easting ^a	Casing Elevation ^b	Depth to Water ^c	Ground Water Elevation ^b
833-03	5-Aug-2017	401392.09	1521955.23	3867.06	Plugged and Abandoned	
	16-May-2017				Dry	
	7-Feb-2017				Dry	
	8-Nov-2016				Dry	
	16-Aug-2016				Dry	
	17-May-2016				Dry	
	10-Feb-2016				Dry	
	5-Nov-2015				Dry	
	17-Aug-2015				Dry	
	6-May-2015				Dry	
	6-Feb-2015				Dry	
	5-Nov-2014				Dry	
	12-Aug-2014				Dry	
	18-Jun-2014				Dry	
	12-Feb-2014				Dry	
	6-Nov-2013				Dry	
	6-Aug-2013				Dry	
	8-May-2013				Dry	
	7-Feb-2013				Dry	
	25-Oct-2012				Dry	
	1-Aug-2012				Dry	
	24-Apr-2012				Dry	
	24-Jan-2012				Dry	
	8-Dec-2011				Dry	
	18-Jul-2011				Dry	
	19-Apr-2011				61.92	3805.14
	17-Jan-2011				61.02	3806.04
	14-Sep-2010				60.91	3806.15
	22-Jun-2010				61.90	3805.16
	22-Mar-2010				61.41	3805.65
	8-Dec-2009				61.16	3805.90
	28-Aug-2009				61.50	3805.56
	26-May-2009				61.26	3805.80
10-Dec-2008	60.76	3806.30				
28-Sep-2008	61.59	3805.47				
10-Jun-2008	61.83	3805.23				
5-Feb-2008	61.11	3805.95				
14-Nov-2007	61.08	3805.98				
12-Sep-2007	61.11	3805.95				

**TABLE 1. SUMMARY OF MONITORING WELL FLUID GAUGING DATA
DONA ANA DAIRIES, DONA ANA COUNTY, NEW MEXICO**

Monitoring Well	Date Measured	Northing ^a	Easting ^a	Casing Elevation ^b	Depth to Water ^c	Ground Water Elevation ^b
833-04	3-May-2023	402898.52	1520659.33	3845.79	45.05	3800.74
	6-Feb-2023				44.15	3801.64
	4-Nov-2022				44.77	3801.02
	4-Aug-2022				44.66	3801.13
	4-May-2022				43.86	3801.93
	9-Feb-2022				42.95	3802.84
	3-Nov-2021				43.77	3802.02
	6-Aug-2021				44.08	3801.71
	5-May-2021				43.25	3802.54
	12-Feb-2021				42.36	3803.43
	4-Nov-2020				42.89	3802.90
	11-Aug-2020				42.91	3802.88
	12-May-2020				42.28	3803.51
	6-Feb-2020				41.99	3803.80
	8-Nov-2019				41.68	3804.11
	5-Aug-2019				43.88	3801.91
	9-May-2019				43.40	3802.39
	20-Feb-2019				42.36	3803.43
	13-Nov-2018				42.81	3802.98
	7-Aug-2018				42.68	3803.11
	14-May-2018				42.59	3803.20
	6-Feb-2018				41.54	3804.25
	7-Nov-2017				42.17	3803.62
	15-Aug-2017				42.90	3802.89
	16-May-2017				43.63	3802.16
	7-Feb-2017				42.47	3803.32
	8-Nov-2016				42.90	3802.89
	16-Aug-2016				43.91	3801.88
	20-May-2016				44.20	3801.59
	10-Feb-2016				43.15	3802.64
	5-Nov-2015				43.92	3801.87
	6-Aug-2015				44.49	3801.30
	6-May-2015				44.98	3800.81
	6-Feb-2015				43.67	3802.12
	5-Nov-2014				43.98	3801.81
	12-Aug-2014				44.62	3801.17
	18-Jun-2014				45.07	3800.72
	12-Feb-2014				43.19	3802.60
	6-Nov-2013				43.59	3802.20
	6-Aug-2013				44.00	3801.79
	8-May-2013				43.63	3802.16
	7-Feb-2013				41.70	3804.09
	25-Oct-2012				41.83	3803.96
	1-Aug-2012				42.70	3803.09
	24-Apr-2012				42.32	3803.47
	24-Jan-2012				40.87	3804.92
	8-Dec-2011				41.55	3804.24
18-Jul-2011	41.05	3804.74				
19-Apr-2011	39.24	3806.55				
17-Jan-2011	38.80	3806.99				
14-Sep-2010	38.84	3806.95				
22-Jun-2010	39.19	3806.60				
22-Mar-2010	39.13	3806.66				
8-Dec-2009	38.85	3806.94				
28-Aug-2009	39.24	3806.55				
26-May-2009	39.31	3806.48				
10-Dec-2008	38.41	3807.38				
28-Sep-2008	38.42	3807.37				
10-Jun-2008	39.46	3806.33				
5-Feb-2008	38.61	3807.18				
14-Nov-2007	38.54	3807.25				
12-Sep-2007	38.96	3806.83				

**TABLE 1. SUMMARY OF MONITORING WELL FLUID GAUGING DATA
DONA ANA DAIRIES, DONA ANA COUNTY, NEW MEXICO**

Monitoring Well	Date Measured	Northing ^a	Easting ^a	Casing Elevation ^b	Depth to Water ^c	Ground Water Elevation ^b
833-05	3-May-2023	399712.39	1522374.73	3865.51	67.57	3797.94
	7-Feb-2023				66.77	3798.74
	4-Nov-2022				67.11	3798.40
	5-Aug-2022				66.78	3798.73
	4-May-2022				66.12	3799.39
	9-Feb-2022				65.17	3800.34
	3-Nov-2021				66.06	3799.45
	6-Aug-2021				66.30	3799.21
	5-May-2021				65.75	3799.76
	12-Feb-2021				64.89	3800.62
	4-Nov-2020				65.24	3800.27
	12-Aug-2020				65.27	3800.24
	12-May-2020				65.91	3799.60
	6-Feb-2020				65.00	3800.51
	7-Nov-2019				65.94	3799.57
	2-Aug-2019				66.10	3799.41
	9-May-2019				65.74	3799.77
	20-Feb-2019				64.85	3800.66
	13-Nov-2018				65.51	3800.00
	7-Aug-2018				65.44	3800.07
	14-May-2018				65.05	3800.46
	6-Feb-2018				64.21	3801.30
	7-Nov-2017				64.45	3801.06
	9-Aug-2017				65.38	3800.13
	16-May-2017				66.10	3799.41
	7-Feb-2017				65.05	3800.46
	8-Nov-2016				65.53	3799.98
	16-Aug-2016				66.06	3799.45
	17-May-2016				66.39	3799.12
	10-Feb-2016				65.94	3799.57
	5-Nov-2015				66.28	3799.23
	6-Aug-2015				66.74	3798.77
	6-May-2015				67.03	3798.48
	6-Feb-2015				65.76	3799.75
	10-Nov-2014				66.10	3799.41
	12-Aug-2014				66.71	3798.80
	18-Jun-2014				66.83	3798.68
	12-Feb-2014				65.32	3800.19
	6-Nov-2013				65.29	3800.22
	6-Aug-2013				65.80	3799.71
8-May-2013	65.19	3800.32				
7-Feb-2013	64.21	3801.30				
25-Oct-2012	64.60	3800.91				
1-Aug-2012	65.01	3800.50				
24-Apr-2012	64.40	3801.11				
24-Jan-2012	63.60	3801.91				
8-Dec-2011	63.63	3801.88				
18-Jul-2011	63.23	3802.28				
19-Apr-2011	62.33	3803.18				
24-Jan-2011	61.90	3803.61				
14-Sep-2010	61.05	3804.46				
22-Jun-2010	61.97	3803.54				
22-Mar-2010	61.52	3803.99				
8-Dec-2009	61.39	3804.12				
28-Aug-2009	61.52	3803.99				
26-May-2009	61.14	3804.37				
10-Dec-2008	61.07	3804.44				
28-Sep-2008	60.99	3804.52				
10-Jun-2008	62.28	3803.23				
5-Feb-2008	61.52	3803.99				

**TABLE 1. SUMMARY OF MONITORING WELL FLUID GAUGING DATA
DONA ANA DAIRIES, DONA ANA COUNTY, NEW MEXICO**

Monitoring Well	Date Measured	Northing ^a	Easting ^a	Casing Elevation ^b	Depth to Water ^c	Ground Water Elevation ^b
833-06	3-May-2023	402219.48	1522652.04	3878.20	77.25	3800.95
	6-Feb-2023				76.90	3801.30
	4-Nov-2022				76.61	3801.59
	4-Aug-2022				76.85	3801.35
	4-May-2022				76.38	3801.82
	9-Feb-2022				75.73	3802.47
	3-Nov-2021				76.40	3801.80
	6-Aug-2021				76.35	3801.85
	5-May-2021				76.11	3802.09
	12-Feb-2021				75.73	3802.47
	4-Nov-2020				76.00	3802.20
	12-Aug-2020				75.51	3802.69
	12-May-2020				76.09	3802.11
	6-Feb-2020				76.00	3802.20
	7-Nov-2019				76.51	3801.69
	2-Aug-2019				76.46	3801.74
	9-May-2019				76.00	3802.20
	20-Feb-2019				75.56	3802.64
	13-Nov-2018				75.75	3802.45
	7-Aug-2018				75.39	3802.81
	14-May-2018				75.05	3803.15
	6-Feb-2018				75.20	3803.00
	7-Nov-2017				75.51	3802.69
	9-Aug-2017				76.35	3801.85
	16-May-2017				76.41	3801.79
	7-Feb-2017				75.84	3802.36
	8-Nov-2016				76.13	3802.07
	16-Aug-2016				76.53	3801.67
	17-May-2016				76.58	3801.62
	10-Feb-2016				76.15	3802.05
	5-Nov-2015				76.11	3802.09
	6-Aug-2015				76.49	3801.71
	6-May-2015				76.57	3801.63
	6-Feb-2015				75.79	3802.41
	5-Nov-2014				75.96	3802.24
	12-Aug-2014				76.20	3802.00
	18-Jun-2014				76.18	3802.02
	12-Feb-2014				75.43	3802.77
	6-Nov-2013				75.12	3803.08
	6-Aug-2013				75.47	3802.73
8-May-2013	74.67	3803.53				
7-Feb-2013	73.80	3804.40				
25-Oct-2012	73.93	3804.27				
1-Aug-2012	74.06	3804.14				
24-Apr-2012	73.97	3804.23				
24-Jan-2012	73.50	3804.70				
8-Dec-2011	73.41	3804.79				
18-Jul-2011	72.93	3805.27				
25-Apr-2001	72.16	3806.04				
17-Jan-2011	71.43	3806.77				
14-Sep-2010	72.05	3806.15				
22-Jun-2010	72.08	3806.12				
22-Mar-2010	72.00	3806.20				
8-Dec-2009	71.92	3806.28				
28-Aug-2009	72.22	3805.98				
26-May-2009	72.02	3806.18				
10-Dec-2008	70.95	3807.25				
28-Sep-2008	70.87	3807.33				
10-Jun-2008	71.78	3806.42				
5-Feb-2008	71.47	3806.73				

**TABLE 1. SUMMARY OF MONITORING WELL FLUID GAUGING DATA
DONA ANA DAIRIES, DONA ANA COUNTY, NEW MEXICO**

Monitoring Well	Date Measured	Northing ^a	Easting ^a	Casing Elevation ^b	Depth to Water ^c	Ground Water Elevation ^b
833-07	3-May-2023	399298.8	1522082.75	3860.70	63.03	3797.67
	7-Feb-2023				62.29	3798.41
	4-Nov-2022				62.57	3798.13
	5-Aug-2022				62.46	3798.24
	4-May-2022				61.80	3798.90
	9-Feb-2022				60.86	3799.84
	3-Nov-2021				61.72	3798.98
	6-Aug-2021				61.97	3798.73
	5-May-2021				61.30	3799.40
	12-Feb-2021				60.33	3800.37
	4-Nov-2020				60.76	3799.94
	12-Aug-2020				60.92	3799.78
	12-May-2020				61.51	3799.19
	6-Feb-2020				61.06	3799.64
	7-Nov-2019				61.46	3799.24
	2-Aug-2019				61.60	3799.10
	9-May-2019				61.38	3799.32
	20-Feb-2019				60.35	3800.35
	13-Nov-2018				61.06	3799.64
	7-Aug-2018				61.07	3799.63
	14-May-2018				60.75	3799.95
	6-Feb-2018				59.74	3800.96
	7-Nov-2017				60.00	3800.70
	9-Aug-2017				60.87	3799.83
	16-May-2017				61.75	3798.95
	7-Feb-2017				60.56	3800.14
	8-Nov-2016				61.27	3799.43
	16-Aug-2016				61.60	3799.10
	17-May-2016				62.10	3798.60
	10-Feb-2016				61.48	3799.22
	5-Nov-2015				61.95	3798.75
	6-Aug-2015				62.28	3798.42
	6-May-2015				62.87	3797.83
	6-Feb-2015				61.34	3799.36
	10-Nov-2014				61.75	3798.95
	12-Aug-2014				62.28	3798.42
	18-Jun-2014				62.58	3798.12
	12-Feb-2014				60.88	3799.82
	6-Nov-2013				61.12	3799.58
	6-Aug-2013				61.45	3799.25
	8-May-2013				60.76	3799.94
	7-Feb-2013				59.82	3800.88
	25-Oct-2012				60.22	3800.48
	1-Aug-2012				60.63	3800.07
	24-Apr-2012				60.25	3800.45
	24-Jan-2012				59.71	3800.99
	8-Dec-2011				59.26	3801.44
18-Jul-2011	58.99	3801.71				
19-Apr-2011	57.95	3802.75				
17-Jan-2011	56.87	3803.83				
14-Sep-2010	56.61	3804.09				
22-Jun-2010	57.55	3803.15				
22-Mar-2010	57.05	3803.65				
8-Dec-2009	56.94	3803.76				
28-Aug-2009	57.02	3803.68				
26-May-2009	56.64	3804.06				
10-Dec-2008	56.58	3804.12				
28-Sep-2008	58.53	3802.17				
10-Jun-2008	57.88	3802.82				
5-Feb-2008	57.11	3803.59				

**TABLE 1. SUMMARY OF MONITORING WELL FLUID GAUGING DATA
DONA ANA DAIRIES, DONA ANA COUNTY, NEW MEXICO**

Monitoring Well	Date Measured	Northing ^a	Easting ^a	Casing Elevation ^b	Depth to Water ^c	Ground Water Elevation ^b
833-08	3-May-2023	400535.64	1521938.23	3861.76	62.92	3798.84
	6-Feb-2023				62.10	3799.66
	4-Nov-2022				62.35	3799.41
	4-Aug-2022				61.95	3799.81
	4-May-2022				61.16	3800.60
	9-Feb-2022				60.24	3801.52
	3-Nov-2021				61.00	3800.76
	6-Aug-2021				61.51	3800.25
	5-May-2021				61.01	3800.75
	12-Feb-2021				60.71	3801.05
	4-Nov-2020				61.01	3800.75
	11-Aug-2020				61.68	3800.08
	12-May-2020				61.12	3800.64
	6-Feb-2020				60.96	3800.80
	7-Nov-2019				61.28	3800.48
	2-Aug-2019				61.46	3800.30
	9-May-2019				60.92	3800.84
	20-Feb-2019				60.10	3801.66
	13-Nov-2018				60.65	3801.11
	7-Aug-2018				60.44	3801.32
	14-May-2018				59.75	3802.01
	6-Feb-2018				59.31	3802.45
	7-Nov-2017				59.51	3802.25
	9-Aug-2017				60.33	3801.43
	16-May-2017				61.03	3800.73
	7-Feb-2017				60.21	3801.55
	8-Nov-2016				60.56	3801.20
	16-Aug-2016				61.21	3800.55
	17-May-2016				61.14	3800.62
	10-Feb-2016				61.11	3800.65
	5-Nov-2015				61.32	3800.44
	6-Aug-2015				61.98	3799.78
	6-May-2015				62.22	3799.54
	6-Feb-2015				61.04	3800.72
	10-Nov-2014				61.22	3800.54
	12-Aug-2014				61.97	3799.79
	18-Jun-2014				62.07	3799.69
	12-Feb-2014				60.68	3801.08
	6-Nov-2013				60.79	3800.97
	6-Aug-2013				61.07	3800.69
	8-May-2013				60.60	3801.16
	7-Feb-2013				59.43	3802.33
25-Oct-2012	59.75	3802.01				
1-Aug-2012	60.24	3801.52				
24-Apr-2012	59.81	3801.95				
24-Jan-2012	58.86	3802.90				
8-Dec-2011	58.96	3802.80				
18-Jul-2011	58.36	3803.40				
25-Apr-2011	56.54	3805.22				
17-Jan-2011	56.55	3805.21				
14-Sep-2010	56.34	3805.42				
22-Jun-2010	57.32	3804.44				
22-Mar-2010	56.83	3804.93				
8-Dec-2009	56.63	3805.13				
28-Aug-2009	56.83	3804.93				
26-May-2009	56.41	3805.35				
10-Dec-2008	56.34	3805.42				
28-Sep-2008	56.07	3805.69				
10-Jun-2008	57.46	3804.30				
5-Feb-2008	56.78	3804.98				

**TABLE 1. SUMMARY OF MONITORING WELL FLUID GAUGING DATA
DONA ANA DAIRIES, DONA ANA COUNTY, NEW MEXICO**

Monitoring Well	Date Measured	Northing ^a	Easting ^a	Casing Elevation ^b	Depth to Water ^c	Ground Water Elevation ^b
833-09	4-May-2023	398280.67	1520918.52	3826.27	29.03	3797.24
	7-Feb-2023				28.26	3798.01
	4-Nov-2022				28.50	3797.77
	5-Aug-2022				29.03	3797.24
	4-May-2022				28.15	3798.12
	9-Feb-2022				27.29	3798.98
	3-Nov-2021				28.11	3798.16
	6-Aug-2021				28.48	3797.79
	5-May-2021				27.57	3798.70
	12-Feb-2021				26.11	3800.16
	4-Nov-2020				26.88	3799.39
	12-Aug-2020				27.02	3799.25
	12-May-2020				27.65	3798.62
	6-Feb-2020				27.06	3799.21
	8-Nov-2019				27.78	3798.49
	2-Aug-2019				27.39	3798.88
	9-May-2019				27.71	3798.56
	20-Feb-2019				26.24	3800.03
	13-Nov-2018				26.73	3799.54
	7-Aug-2018				27.00	3799.27
	14-May-2018				27.19	3799.08
	6-Feb-2018				25.77	3800.50
	7-Nov-2017				25.92	3800.35
	9-Aug-2017				26.22	3800.05
	16-May-2017				28.00	3798.27
	7-Feb-2017				26.48	3799.79
	8-Nov-2016				27.24	3799.03
	16-Aug-2016				26.92	3799.35
	17-May-2016				28.82	3797.45
	10-Feb-2016				27.49	3798.78
	5-Nov-2015				27.98	3798.29
	6-Aug-2015				27.74	3798.53
	6-May-2015				28.86	3797.41
	6-Feb-2015				27.20	3799.07
	5-Nov-2014				27.74	3798.53
	12-Aug-2014				27.71	3798.56
	18-Jun-2014				28.71	3797.56
	12-Feb-2014				26.82	3799.45
	6-Nov-2013				27.49	3798.78
	6-Aug-2013				27.76	3798.51
8-May-2013	27.31	3798.96				
7-Feb-2013	26.26	3800.01				
25-Oct-2012	26.30	3799.97				
1-Aug-2012	27.21	3799.06				
24-Apr-2012	26.44	3799.83				
24-Jan-2012	25.42	3800.85				
8-Dec-2011	25.08	3801.19				
18-Jul-2011	25.41	3800.86				
25-Apr-2011	22.86	3803.41				
17-Jan-2011	22.87	3803.40				
15-Sep-2010	22.56	3803.71				
22-Jun-2010	23.99	3802.28				
22-Mar-2010	23.20	3803.07				
8-Dec-2009	22.87	3803.40				
28-Aug-2009	22.67	3803.60				
26-May-2009	22.40	3803.87				
10-Dec-2008	22.65	3803.62				
28-Sep-2008	22.18	3804.09				
10-Jun-2008	23.71	3802.56				
5-Feb-2008	23.23	3803.04				

**TABLE 1. SUMMARY OF MONITORING WELL FLUID GAUGING DATA
DONA ANA DAIRIES, DONA ANA COUNTY, NEW MEXICO**

Monitoring Well	Date Measured	Northing ^a	Easting ^a	Casing Elevation ^b	Depth to Water ^c	Ground Water Elevation ^b
833-10	4-May-2023	396715.89	1520283.6	3820.76	23.51	3797.25
	7-Feb-2023				22.91	3797.85
	4-Nov-2022				23.18	3797.58
	5-Aug-2022				22.85	3797.91
	4-May-2022				22.66	3798.10
	9-Feb-2022				21.84	3798.92
	3-Nov-2021				22.50	3798.26
	6-Aug-2021				22.28	3798.48
	5-May-2021				21.69	3799.07
	12-Feb-2021				20.70	3800.06
	4-Nov-2020				20.90	3799.86
	12-Aug-2020				21.20	3799.56
	12-May-2020				22.00	3798.76
	6-Feb-2020				21.02	3799.74
	8-Nov-2019				21.38	3799.38
	2-Aug-2019				20.35	3800.41
	9-May-2019				22.12	3798.64
	20-Feb-2019				21.04	3799.72
	13-Nov-2018				21.16	3799.60
	7-Aug-2018				20.89	3799.87
	14-May-2018				22.03	3798.73
	6-Feb-2018				20.60	3800.16
	7-Nov-2017				20.65	3800.11
	9-Aug-2017				20.58	3800.18
	16-May-2017				22.66	3798.10
	7-Feb-2017				21.55	3799.21
	8-Nov-2016				21.86	3798.90
	16-Aug-2016				20.55	3800.21
	17-May-2016				23.34	3797.42
	10-Feb-2016				22.38	3798.38
	5-Nov-2015				22.80	3797.96
	6-Aug-2015				20.95	3799.81
	6-May-2015				23.58	3797.18
	6-Feb-2015				22.24	3798.52
	10-Nov-2014				22.95	3797.81
	12-Aug-2014				21.05	3799.71
	18-Jun-2014				22.37	3798.39
	12-Feb-2014				21.61	3799.15
	6-Nov-2013				21.76	3799.00
	6-Aug-2013				21.95	3798.81
8-May-2013	22.26	3798.50				
7-Feb-2013	21.12	3799.64				
25-Oct-2012	20.93	3799.83				
1-Aug-2012	21.01	3799.75				
24-Apr-2012	21.11	3799.65				
24-Jan-2012	20.14	3800.62				
8-Dec-2011	19.95	3800.81				
18-Jul-2011	19.23	3801.53				
19-Apr-2011	18.67	3802.09				
17-Jan-2011	17.80	3802.96				
15-Sep-2010	17.29	3803.47				
22-Jun-2010	18.80	3801.96				
22-Mar-2010	18.38	3802.38				
8-Dec-2009	17.72	3803.04				
28-Aug-2009	17.22	3803.54				
26-May-2009	17.40	3803.36				
10-Dec-2008	17.71	3803.05				
28-Sep-2008	16.98	3803.78				
10-Jun-2008	18.17	3802.59				
5-Feb-2008	18.11	3802.65				

**TABLE 1. SUMMARY OF MONITORING WELL FLUID GAUGING DATA
DONA ANA DAIRIES, DONA ANA COUNTY, NEW MEXICO**

Monitoring Well	Date Measured	Northing ^a	Easting ^a	Casing Elevation ^b	Depth to Water ^c	Ground Water Elevation ^b
Sunset/Desert Land Dairy						
257-01	4-May-2023	395856.31	1520572.16	3820.33	22.40	3797.93
	7-Feb-2023				21.59	3798.74
	4-Nov-2022				22.90	3797.43
	5-Aug-2022				22.17	3798.16
	4-May-2022				22.44	3797.89
	9-Feb-2022				21.90	3798.43
	3-Nov-2021				22.62	3797.71
	6-Aug-2021				22.11	3798.22
	5-May-2021				21.83	3798.50
	12-Feb-2021				20.87	3799.46
	4-Nov-2020				20.00	3800.33
	12-Aug-2020				20.16	3800.17
	12-May-2020				20.94	3799.39
	6-Feb-2020				19.00	3801.33
	8-Nov-2019				18.93	3801.40
	2-Aug-2019				19.68	3800.65
	9-May-2019				21.99	3798.34
	19-Feb-2019				20.85	3799.48
	13-Nov-2018				21.16	3799.17
	7-Aug-2018				20.60	3799.73
	14-May-2018				22.23	3798.10
	6-Feb-2018				20.54	3799.79
	7-Nov-2017				20.91	3799.42
	9-Aug-2017				20.73	3799.60
	16-May-2017				22.82	3797.51
	7-Feb-2017				21.70	3798.63
	8-Nov-2016				22.16	3798.17
	16-Aug-2016				20.88	3799.45
	16-May-2016				23.72	3796.61
	10-Feb-2016				22.30	3798.03
	6-Nov-2015				22.99	3797.34
	6-Aug-2015				21.13	3799.20
	6-May-2015				24.16	3796.17
	6-Feb-2015				22.36	3797.97
	10-Nov-2014				23.20	3797.13
	12-Aug-2014				22.50	3797.83
	18-Jun-2014				22.67	3797.66
	12-Feb-2014				21.67	3798.66
	6-Nov-2013				22.29	3798.04
	6-Aug-2013				22.52	3797.81
7-May-2013	21.15	3799.18				
7-Feb-2013	20.38	3799.95				
26-Oct-2012	21.04	3799.29				
1-Aug-2012	20.82	3799.51				
24-Apr-2012	21.01	3799.32				
24-Jan-2012	20.09	3800.24				
8-Dec-2011	20.18	3800.15				
18-Jul-2011	19.75	3800.58				
19-Apr-2011	18.52	3801.81				
18-Jan-2011	17.83	3802.50				
15-Sep-2010	17.15	3803.18				
22-Jun-2010	18.15	3802.18				
22-Mar-2010	18.40	3801.93				
8-Dec-2009	17.66	3802.67				
28-Aug-2009	16.99	3803.34				
26-May-2009	17.41	3802.92				
10-Dec-2008	17.87	3802.46				
27-Sep-2008	16.75	3803.58				
10-Jun-2008	17.88	3802.45				
5-Feb-2008	17.59	3802.74				
14-Nov-2007	18.53	3801.80				
12-Sep-2007	18.10	3802.23				

**TABLE 1. SUMMARY OF MONITORING WELL FLUID GAUGING DATA
DONA ANA DAIRIES, DONA ANA COUNTY, NEW MEXICO**

Monitoring Well	Date Measured	Northing ^a	Easting ^a	Casing Elevation ^b	Depth to Water ^c	Ground Water Elevation ^b
257-02	4-May-2023	394728.34	1521030.29	3813.67	17.34	3796.33
	7-Feb-2023				16.80	3796.87
	4-Nov-2022				17.14	3796.53
	5-Aug-2022				17.42	3796.25
	4-May-2022				17.06	3796.61
	9-Feb-2022				16.18	3797.49
	3-Nov-2021				16.42	3797.25
	6-Aug-2021				16.21	3797.46
	5-May-2021				15.90	3797.77
	12-Feb-2021				15.08	3798.59
	4-Nov-2020				15.11	3798.56
	12-Aug-2020				14.88	3798.79
	12-May-2020				15.65	3798.02
	6-Feb-2020				14.90	3798.77
	7-Nov-2019				14.89	3798.78
	2-Aug-2019				15.00	3798.67
	9-May-2019				15.71	3797.96
	19-Feb-2019				15.05	3798.62
	13-Nov-2018				15.50	3798.17
	7-Aug-2018				14.52	3799.15
	14-May-2018				16.30	3797.37
	6-Feb-2018				13.75	3799.92
	7-Nov-2017				14.84	3798.83
	9-Aug-2017				15.14	3798.53
	16-May-2017				16.89	3796.78
	7-Feb-2017				15.68	3797.99
	8-Nov-2016				16.40	3797.27
	16-Aug-2016				15.88	3797.79
	16-May-2016				18.19	3795.48
	10-Feb-2016				16.76	3796.91
	6-Nov-2015				17.65	3796.02
	17-Aug-2015				16.41	3797.26
	6-May-2015				18.20	3795.47
	6-Feb-2015				16.75	3796.92
	10-Nov-2014				17.45	3796.22
	13-Aug-2014				16.50	3797.17
	18-Jun-2014				17.87	3795.80
	12-Feb-2014				15.78	3797.89
	6-Nov-2013				16.06	3797.61
	6-Aug-2013				15.95	3797.72
7-May-2013	15.04	3798.63				
7-Feb-2013	14.79	3798.88				
26-Oct-2012	15.06	3798.61				
1-Aug-2012	14.91	3798.76				
24-Apr-2012	15.27	3798.40				
24-Jan-2012	13.90	3799.77				
8-Dec-2011	14.38	3799.29				
19-Jul-2011	13.50	3800.17				
19-Apr-2011	12.59	3801.08				
18-Jan-2011	11.84	3801.83				
15-Sep-2010	10.86	3802.81				
22-Jun-2010	11.08	3802.59				
22-Mar-2010	12.22	3801.45				
8-Dec-2009	11.52	3802.15				
28-Aug-2009	10.86	3802.81				
26-May-2009	11.38	3802.29				
10-Dec-2008	11.67	3802.00				
27-Sep-2008	9.75	3803.92				
10-Jun-2008	11.82	3801.85				
5-Feb-2008	11.67	3802.00				
14-Nov-2007	12.22	3801.45				
12-Sep-2007	11.55	3802.12				

**TABLE 1. SUMMARY OF MONITORING WELL FLUID GAUGING DATA
DONA ANA DAIRIES, DONA ANA COUNTY, NEW MEXICO**

Monitoring Well	Date Measured	Northing ^a	Easting ^a	Casing Elevation ^b	Depth to Water ^c	Ground Water Elevation ^b
257-03	4-May-2023	397935.69	1518746.14	3814.74	14.93	3799.81
	7-Feb-2023				14.08	3800.66
	4-Nov-2022				14.59	3800.15
	5-Aug-2022				14.30	3800.44
	4-May-2022				13.92	3800.82
	9-Feb-2022				14.04	3800.70
	3-Nov-2021				13.54	3801.20
	6-Aug-2021				13.80	3800.94
	5-May-2021				12.38	3802.36
	12-Feb-2021				11.58	3803.16
	4-Nov-2020				11.26	3803.48
	12-Aug-2020				10.86	3803.88
	12-May-2020				Dry	
	6-Feb-2020				12.93	3801.81
	8-Nov-2019				12.03	3802.71
	2-Aug-2019				12.30	3802.44
	9-May-2019				13.48	3801.26
	19-Feb-2019				13.35	3801.39
	13-Nov-2018				12.89	3801.85
	7-Aug-2018				11.82	3802.92
	14-May-2018				13.08	3801.66
	6-Feb-2018				11.86	3802.88
	7-Nov-2017				10.05	3804.69
	9-Aug-2017				11.58	3803.16
	16-May-2017				13.61	3801.13
	7-Feb-2017				13.17	3801.57
	8-Nov-2016				11.80	3802.94
	16-Aug-2016				12.13	3802.61
	16-May-2016				Dry	
	10-Feb-2016				13.45	3801.29
	6-Nov-2015				13.96	3800.78
	6-Aug-2015				11.35	3803.39
	6-May-2015				Dry	
	6-Feb-2015				Dry	
	10-Nov-2014				Dry	
	13-Aug-2014				12.34	3802.40
	18-Jun-2014				12.21	3802.53
	12-Feb-2014				13.49	3801.25
	6-Nov-2013				11.04	3803.70
	6-Aug-2013				11.29	3803.45
	7-May-2013				12.98	3801.76
	7-Feb-2013				12.31	3802.43
	26-Oct-2012				11.61	3803.13
	1-Aug-2012				10.06	3804.68
	24-Apr-2012				11.56	3803.18
	24-Jan-2012				10.89	3803.85
	1-Nov-2011				11.29	3803.45
	18-Jul-2011				8.77	3805.97
	19-Apr-2011				9.31	3805.43
	17-Jan-2011				10.04	3804.70
	21-Sep-2010				9.26	3805.48
	22-Jun-2010				9.11	3805.63
	22-Mar-2010				10.45	3804.29
8-Dec-2009	9.78	3804.96				
28-Aug-2009	9.43	3805.31				
26-May-2009	9.55	3805.19				
10-Dec-2008	10.26	3804.48				
27-Sep-2008	9.73	3805.01				
10-Jun-2008	9.70	3805.04				
5-Feb-2008	11.04	3803.70				
14-Nov-2007	9.03	3805.71				
12-Sep-2007	9.61	3805.13				

**TABLE 1. SUMMARY OF MONITORING WELL FLUID GAUGING DATA
DONA ANA DAIRIES, DONA ANA COUNTY, NEW MEXICO**

Monitoring Well	Date Measured	Northing ^a	Easting ^a	Casing Elevation ^b	Depth to Water ^c	Ground Water Elevation ^b
257/260-01	2-Feb-2018	397678.36	1519948.22	3814.04	Plugged and Abandoned	
	7-Nov-2017				Crops too high	
	18-Aug-2017				12.44	Broken casing
	16-May-2017				12.47	Broken casing
	7-Feb-2017				5.14	Broken casing
	8-Nov-2016				5.65	Broken casing
	16-Aug-2016				NM	NM
	16-May-2016				7.12	Broken casing
	10-Feb-2016				Broken casing	
	6-Nov-2015				12.85	3801.19
	13-Aug-2015				Crops too high	
	6-May-2015				17.12	3796.92
	6-Feb-2015				14.71	3799.33
	5-Nov-2014				14.93	3799.11
	13-Aug-2014				13.28	3800.76
	18-Jun-2014				14.53	3799.51
	12-Feb-2014				14.06	3799.98
	6-Nov-2013				14.01	3800.03
	14-Aug-2013				14.20	3799.84
	7-May-2013				13.83	3800.21
	7-Feb-2013				13.11	3800.93
	26-Oct-2012				13.36	3800.68
	1-Aug-2012				13.05	3800.99
	24-Apr-2012				12.98	3801.06
	30-Jan-2012				12.26	3801.78
	1-Nov-2011				12.79	3801.25
	18-Jul-2011				10.65	3803.39
	26-Apr-2011				11.66	3802.38
	17-Jan-2011				10.44	3803.60
	15-Sep-2010				9.94	3804.10
	22-Jun-2010				10.90	3803.14
	22-Mar-2010				10.71	3803.33
8-Dec-2009	10.42	3803.62				
28-Aug-2009	10.11	3803.93				
26-May-2009	10.00	3804.04				
10-Dec-2008	10.48	3803.56				
27-Sep-2008	9.80	3804.24				
10-Jun-2008	11.00	3803.04				
5-Feb-2008	10.99	3803.05				
14-Nov-2007	11.21	3802.83				
12-Sep-2007	NM	NM				
Additional Wells						
Bruce1	18-Jul-2011	388741.02	1523777.06	3808.92	Destroyed	
	19-Apr-2011				11.17	3797.75
	17-Jan-2011				11.13	3797.79
	15-Sep-2010				10.38	3798.54
	23-Jun-2010				10.99	3797.93
	21-Mar-2010				11.50	3797.42
	8-Dec-2009				11.05	3797.87
	27-Aug-2009				10.41	3798.51
	27-May-2009				10.77	3798.15
	10-Dec-2008				11.28	3797.64
	27-Sep-2008				10.93	3797.99
	10-Jun-2008				11.28	3797.64
	5-Feb-2008				11.47	3797.45
Bruce2	5-Feb-2008	NM	NM	NM	Destroyed	
	10-Jun-2008				8.33	--

**TABLE 1. SUMMARY OF MONITORING WELL FLUID GAUGING DATA
DONA ANA DAIRIES, DONA ANA COUNTY, NEW MEXICO**

Monitoring Well	Date Measured	Northing ^a	Easting ^a	Casing Elevation ^b	Depth to Water ^c	Ground Water Elevation ^b
SOUTHERN AREA						
Del Oro Dairy						
692-01	22-Dec-2015	373615.88	1531529.38	3844.13	Plugged and Abandoned	
	6-Nov-2015				62.12	3782.01
	6-Aug-2015				61.75	3782.38
	6-May-2015				63.02	3781.11
	6-Feb-2015				61.28	3782.85
	5-Nov-2014				61.43	3782.70
	12-Aug-2014				61.27	3782.86
	13-May-2014				60.79	3783.34
	14-Feb-2014				60.38	3783.75
	6-Nov-2013				60.72	3783.41
	6-Aug-2013				60.30	3783.83
	7-May-2013				60.58	3783.55
	7-Feb-2013				59.93	3784.20
	26-Oct-2012				60.10	3784.03
	1-Aug-2012				58.79	3785.34
	24-Apr-2012				58.43	3785.70
	25-Jan-2012				78.58	Pumping
	9-Dec-2011				58.19	3785.94
	18-Jul-2011				57.79	3786.34
	19-Apr-2011				57.39	3786.74
	18-Jan-2011				57.17	3786.96
	15-Sep-2010				57.57	3786.56
	30-Jun-2010				61.15	Pumping
	22-Mar-2010				58.01	3786.12
	9-Dec-2009				58.25	3785.88
	29-Aug-2009				58.19	3785.94
	26-May-2009				57.80	3786.33
	11-Dec-2008				Pumping	NM
	28-Sep-2008				Pumping	NM
	11-Jun-2008				57.75	3786.38
	6-Feb-2008				57.42	3786.71
	14-Nov-2007				57.38	3786.75
	13-Sep-2007				57.46	3786.67

**TABLE 1. SUMMARY OF MONITORING WELL FLUID GAUGING DATA
DONA ANA DAIRIES, DONA ANA COUNTY, NEW MEXICO**

Monitoring Well	Date Measured	Northing ^a	Easting ^a	Casing Elevation ^b	Depth to Water ^c	Ground Water Elevation ^b
692-02	4-May-2023	372984.72	1531192.1	3840.84	60.40	3780.44
	7-Feb-2023				59.94	3780.90
	4-Nov-2022				59.70	3781.14
	5-Aug-2022				59.25	3781.59
	4-May-2022				58.46	3782.38
	10-Feb-2022				57.63	3783.21
	3-Nov-2021				58.45	3782.39
	6-Aug-2021				58.05	3782.79
	5-May-2021				56.69	3784.15
	12-Feb-2021				55.03	3785.81
	4-Nov-2020				54.17	3786.67
	12-Aug-2020				53.90	3786.94
	12-May-2020				54.75	3786.09
	6-Feb-2020				53.86	3786.98
	7-Nov-2019				50.24	3790.60
	5-Aug-2019				53.06	3787.78
	9-May-2019				59.91	3780.93
	20-Feb-2019				59.00	3781.84
	13-Nov-2018				60.67	3780.17
	7-Aug-2018				60.82	3780.02
	17-May-2018				60.68	3780.16
	6-Feb-2018				60.60	3780.24
	7-Nov-2017				60.78	3780.06
	9-Aug-2017				61.10	3779.74
	16-May-2017				60.65	3780.19
	7-Feb-2017				60.60	3780.24
	8-Nov-2016				60.65	3780.19
	16-Aug-2016				60.58	3780.26
	17-May-2016				60.25	3780.59
	10-Feb-2016				60.11	3780.73
	6-Nov-2015				59.74	3781.10
	6-Aug-2015				59.66	3781.18
	6-May-2015				59.50	3781.34
	6-Feb-2015				59.02	3781.82
	5-Nov-2014				59.27	3781.57
	12-Aug-2014				59.01	3781.83
	13-May-2014				58.51	3782.33
	14-Feb-2014				58.12	3782.72
	6-Nov-2013				57.91	3782.93
	6-Aug-2013				57.60	3783.24
7-May-2013	57.39	3783.45				
7-Feb-2013	56.86	3783.98				
25-Oct-2012	56.48	3784.36				
1-Aug-2012	56.03	3784.81				
24-Apr-2012	55.71	3785.13				
25-Jan-2012	54.70	3786.14				
13-Dec-2011	54.94	3785.90				
18-Jul-2011	55.10	3785.74				
19-Apr-2011	54.68	3786.16				
18-Jan-2011	54.32	3786.52				
15-Sep-2010	54.39	3786.45				
30-Jun-2010	54.50	3786.34				
22-Mar-2010	54.90	3785.94				
9-Dec-2009	55.11	3785.73				
28-Aug-2009	55.03	3785.81				
26-May-2009	55.38	3785.46				
11-Dec-2008	54.93	3785.91				
28-Sep-2008	54.69	3786.15				
11-Jun-2008	54.93	3785.91				
6-Feb-2008	54.74	3786.10				
14-Nov-2007	54.42	3786.42				
13-Sep-2007	54.61	3786.23				

**TABLE 1. SUMMARY OF MONITORING WELL FLUID GAUGING DATA
DONA ANA DAIRIES, DONA ANA COUNTY, NEW MEXICO**

Monitoring Well	Date Measured	Northing ^a	Easting ^a	Casing Elevation ^b	Depth to Water ^c	Ground Water Elevation ^b
692-04	4-May-2023	372982.53	1531555.21	3842.66	Dry	
	7-Feb-2023				Dry	
	4-Nov-2022				Dry	
	5-Aug-2022				Dry	
	4-May-2022				60.01	3782.65
	10-Feb-2022				59.40	3783.26
	3-Nov-2021				59.90	3782.76
	6-Aug-2021				60.40	3782.26
	5-May-2021				60.35	3782.31
	12-Feb-2021				60.09	3782.57
	4-Nov-2020				59.49	3783.17
	12-Aug-2020				58.70	3783.96
	12-May-2020				59.61	3783.05
	6-Feb-2020				58.03	3784.63
	7-Nov-2019				55.75	3786.91
	5-Aug-2019				58.80	3783.86
	9-May-2019				Dry	
	20-Feb-2019				Dry	
	13-Nov-2018				Dry	
	7-Aug-2018				Dry	
	17-May-2018				Dry	
	6-Feb-2018				Dry	
	7-Nov-2017				Dry	
	9-Aug-2017				Dry	
	16-May-2017				Dry	
	7-Feb-2017				Dry	
	8-Nov-2016				Dry	
	16-Aug-2016				Dry	
	17-May-2016				Dry	
	10-Feb-2016				Dry	
	6-Nov-2015				Dry	
	6-Aug-2015				60.53	3782.13
	6-May-2015				61.99	3780.67
	6-Feb-2015				60.20	3782.46
	5-Nov-2014				60.44	3782.22
	12-Aug-2014				60.13	3782.53
	13-May-2014				59.66	3783.00
	14-Feb-2014				59.18	3783.48
	6-Nov-2013				59.03	3783.63
	6-Aug-2013				58.79	3783.87
	7-May-2013				58.68	3783.98
	7-Feb-2013				58.05	3784.61
	25-Oct-2012				57.62	3785.04
	1-Aug-2012				57.34	3785.32
	24-Apr-2012				57.13	3785.53
	25-Jan-2012				56.34	3786.32
	9-Dec-2011				56.91	3785.75
	18-Jul-2011				56.92	3785.74
	19-Apr-2011				56.47	3786.19
	18-Jan-2011				56.15	3786.51
15-Sep-2010	55.90	3786.76				
30-Jun-2010	56.81	3785.85				
22-Mar-2010	56.81	3785.85				
8-Dec-2009	56.86	3785.80				
28-Aug-2009	56.82	3785.84				
26-May-2009	57.09	3785.57				
11-Dec-2008	56.71	3785.95				
28-Sep-2008	56.41	3786.25				
11-Jun-2008	56.54	3786.12				
6-Feb-2008	56.40	3786.26				
14-Nov-2007	55.95	3786.71				
13-Sep-2007	56.19	3786.47				

**TABLE 1. SUMMARY OF MONITORING WELL FLUID GAUGING DATA
DONA ANA DAIRIES, DONA ANA COUNTY, NEW MEXICO**

Monitoring Well	Date Measured	Northing ^a	Easting ^a	Casing Elevation ^b	Depth to Water ^c	Ground Water Elevation ^b
692-05	4-May-2023	374807.26	1532403	3854.26	81.02	3773.24
	7-Feb-2023				81.46	3772.80
	4-Nov-2022				82.30	3771.96
	5-Aug-2022				82.40	3771.86
	4-May-2022				81.60	3772.66
	10-Feb-2022				80.87	3773.39
	3-Nov-2021				81.98	3772.28
	6-Aug-2021				82.70	3771.56
	5-May-2021				81.20	3773.06
	12-Feb-2021				80.58	3773.68
	4-Nov-2020				81.25	3773.01
	12-Aug-2020				80.95	3773.31
	12-May-2020				81.20	3773.06
	6-Feb-2020				80.62	3773.64
	7-Nov-2019				80.62	3773.64
	5-Aug-2019				81.35	3772.91
	9-May-2019				81.34	3772.92
	20-Feb-2019				80.65	3773.61
	13-Nov-2018				81.85	3772.41
	7-Aug-2018				81.75	3772.51
	17-May-2018				81.44	3772.82
	6-Feb-2018				80.20	3774.06
	7-Nov-2017				81.05	3773.21
	9-Aug-2017				81.47	3772.79
	16-May-2017				81.60	3772.66
	7-Feb-2017				80.41	3773.85
	8-Nov-2016				81.78	3772.48
	16-Aug-2016				81.70	3772.56
	17-May-2016				81.25	3773.01
	10-Feb-2016				80.30	3773.96
	6-Nov-2015				81.13	3773.13
	6-Aug-2015				80.85	3773.41
	6-May-2015				81.97	3772.29
	6-Feb-2015				80.08	3774.18
	5-Nov-2014				81.06	3773.20
	12-Aug-2014				81.02	3773.24
	13-May-2014				80.82	3773.44
	13-Feb-2014				79.21	3775.05
	6-Nov-2013				NM	NM
	14-Aug-2013				78.12	3776.14
	7-May-2013				79.43	3774.83
	7-Feb-2013				78.86	3775.40
	26-Oct-2012				79.11	3775.15
	1-Aug-2012				78.80	3775.46
	24-Apr-2012				77.96	3776.30
	24-Jan-2012				76.80	3777.46
	9-Dec-2011				77.39	3776.87
18-Jul-2011	77.59	3776.67				
19-Apr-2011	76.46	3777.80				
18-Jan-2011	75.55	3778.71				
15-Sep-2010	76.14	3778.12				
30-Jun-2010	76.20	3778.06				
22-Mar-2010	75.01	3779.25				
9-Dec-2009	75.52	3778.74				
28-Aug-2009	76.15	3778.11				
26-May-2009	75.65	3778.61				
11-Dec-2008	74.95	3779.31				
28-Sep-2008	75.36	3778.90				
11-Jun-2008	75.72	3778.54				
6-Feb-2008	74.84	3779.42				
14-Nov-2007	75.90	3778.36				
13-Sep-2007	75.84	3778.42				

**TABLE 1. SUMMARY OF MONITORING WELL FLUID GAUGING DATA
DONA ANA DAIRIES, DONA ANA COUNTY, NEW MEXICO**

Monitoring Well	Date Measured	Northing ^a	Easting ^a	Casing Elevation ^b	Depth to Water ^c	Ground Water Elevation ^b
692-06	4-May-2023	375054.77	1532411.83	3856.48	84.20	3772.28
	7-Feb-2023				83.38	3773.10
	4-Nov-2022				84.25	3772.23
	5-Aug-2022				84.28	3772.20
	4-May-2022				83.57	3772.91
	10-Feb-2022				82.94	3773.54
	3-Nov-2021				83.83	3772.65
	6-Aug-2021				83.60	3772.88
	5-May-2021				83.08	3773.40
	12-Feb-2021				83.90	3772.58
	4-Nov-2020				83.10	3773.38
	12-Aug-2020				82.69	3773.79
	12-May-2020				83.47	3773.01
	6-Feb-2020				82.88	3773.60
	7-Nov-2019				83.64	3772.84
	5-Aug-2019				83.25	3773.23
	9-May-2019				83.20	3773.28
	20-Feb-2019				82.50	3773.98
	13-Nov-2018				83.69	3772.79
	7-Aug-2018				83.58	3772.90
	17-May-2018				83.25	3773.23
	6-Feb-2018				82.00	3774.48
	7-Nov-2017				82.86	3773.62
	9-Aug-2017				83.28	3773.20
	16-May-2017				83.35	3773.13
	7-Feb-2017				82.20	3774.28
	8-Nov-2016				83.55	3772.93
	16-Aug-2016				83.45	3773.03
	17-May-2016				83.08	3773.40
	10-Feb-2016				82.12	3774.36
	6-Nov-2015				82.92	3773.56
	6-Aug-2015				82.68	3773.80
	6-May-2015				83.11	3773.37
	6-Feb-2015				81.65	3774.83
	5-Nov-2014				82.91	3773.57
	12-Aug-2014				82.88	3773.60
	13-May-2014				81.84	3774.64
	14-Feb-2014				81.31	3775.17
	6-Nov-2013				82.18	3774.30
	6-Aug-2013				81.86	3774.62
	7-May-2013				81.22	3775.26
	7-Feb-2013				80.88	3775.60
	26-Oct-2012				81.03	3775.45
	1-Aug-2012				80.69	3775.79
	24-Apr-2012				79.84	3776.64
	30-Jan-2012				78.99	3777.49
	9-Dec-2011				79.32	3777.16
18-Jul-2011	79.43	3777.05				
19-Apr-2011	78.32	3778.16				
18-Jan-2011	77.44	3779.04				
15-Sep-2010	78.02	3778.46				
30-Jun-2010	78.12	3778.36				
22-Mar-2010	76.91	3779.57				
9-Dec-2009	77.44	3779.04				
28-Aug-2009	78.04	3778.44				
26-May-2009	77.53	3778.95				
11-Dec-2008	76.79	3779.69				
28-Sep-2008	77.25	3779.23				
11-Jun-2008	77.60	3778.88				
6-Feb-2008	76.76	3779.72				
14-Nov-2007	77.80	3778.68				
13-Sep-2007	77.75	3778.73				

**TABLE 1. SUMMARY OF MONITORING WELL FLUID GAUGING DATA
DONA ANA DAIRIES, DONA ANA COUNTY, NEW MEXICO**

Monitoring Well	Date Measured	Northing ^a	Easting ^a	Casing Elevation ^b	Depth to Water ^c	Ground Water Elevation ^b
692-07	4-May-2023	374944.88	1532019.81	3848.20	76.30	3771.90
	7-Feb-2023				76.10	3772.10
	4-Nov-2022				76.91	3771.29
	5-Aug-2022				76.28	3771.92
	4-May-2022				75.60	3772.60
	10-Feb-2022				74.77	3773.43
	3-Nov-2021				75.66	3772.54
	6-Aug-2021				75.80	3772.40
	5-May-2021				75.00	3773.20
	12-Feb-2021				74.02	3774.18
	4-Nov-2020				74.88	3773.32
	12-Aug-2020				74.71	3773.49
	12-May-2020				75.03	3773.17
	6-Feb-2020				74.82	3773.38
	7-Nov-2019				75.20	3773.00
	5-Aug-2019				74.95	3773.25
	9-May-2019				75.10	3773.10
	20-Feb-2019				74.11	3774.09
	13-Nov-2018				75.38	3772.82
	7-Aug-2018				75.47	3772.73
	17-May-2018				75.27	3772.93
	6-Feb-2018				73.70	3774.50
	7-Nov-2017				74.54	3773.66
	9-Aug-2017				75.00	3773.20
	16-May-2017				75.44	3772.76
	7-Feb-2017				73.91	3774.29
	8-Nov-2016				75.40	3772.80
	16-Aug-2016				75.27	3772.93
	17-May-2016				75.00	3773.20
	10-Feb-2016				73.87	3774.33
	6-Nov-2015				74.81	3773.39
	6-Aug-2015				74.52	3773.68
	6-May-2015				75.04	3773.16
	6-Feb-2015				73.40	3774.80
	5-Nov-2014				74.65	3773.55
	12-Aug-2014				74.94	3773.26
	13-May-2014				73.69	3774.51
	14-Feb-2014				73.14	3775.06
	6-Nov-2013				74.26	3773.94
	6-Aug-2013				73.92	3774.28
7-May-2013	73.21	3774.99				
7-Feb-2013	72.55	3775.65				
26-Oct-2012	72.78	3775.42				
1-Aug-2012	72.60	3775.60				
24-Apr-2012	71.84	3776.36				
24-Jan-2012	70.30	3777.90				
13-Dec-2011	70.54	3777.66				
18-Jul-2011	71.32	3776.88				
19-Apr-2011	70.22	3777.98				
18-Jan-2011	69.01	3779.19				
15-Sep-2010	69.72	3778.48				
30-Jun-2010	69.87	3778.33				
22-Mar-2010	68.59	3779.61				
9-Dec-2009	68.97	3779.23				
28-Aug-2009	69.71	3778.49				
26-May-2009	69.35	3778.85				
11-Dec-2008	68.38	3779.82				
28-Sep-2008	68.99	3779.21				
11-Jun-2008	69.35	3778.85				
6-Feb-2008	68.44	3779.76				
14-Nov-2007	69.46	3778.74				
13-Sep-2007	69.46	3778.74				

**TABLE 1. SUMMARY OF MONITORING WELL FLUID GAUGING DATA
DONA ANA DAIRIES, DONA ANA COUNTY, NEW MEXICO**

Monitoring Well	Date Measured	Northing ^a	Easting ^a	Casing Elevation ^b	Depth to Water ^c	Ground Water Elevation ^b
692-08	4-May-2023	375535.69	1531378.09	3843.09	70.00	3773.09
	7-Feb-2023				69.09	3774.00
	4-Nov-2022				69.94	3773.15
	5-Aug-2022				69.81	3773.28
	4-May-2022				69.02	3774.07
	10-Feb-2022				68.10	3774.99
	3-Nov-2021				69.83	3773.26
	6-Aug-2021				70.20	3772.89
	5-May-2021				69.50	3773.59
	12-Feb-2021				68.70	3774.39
	4-Nov-2020				68.90	3774.19
	12-Aug-2020				68.03	3775.06
	12-May-2020				68.80	3774.29
	6-Feb-2020				67.75	3775.34
	7-Nov-2019				68.95	3774.14
	5-Aug-2019				68.76	3774.33
	9-May-2019				68.78	3774.31
	20-Feb-2019				67.75	3775.34
	13-Nov-2018				68.93	3774.16
	7-Aug-2018				69.66	3773.43
	17-May-2018				70.00	3773.09
	6-Feb-2018				67.29	3775.80
	7-Nov-2017				68.25	3774.84
	9-Aug-2017				68.70	3774.39
	16-May-2017				69.98	3773.11
	7-Feb-2017				67.50	3775.59
	8-Nov-2016				69.25	3773.84
	16-Aug-2016				69.32	3773.77
	17-May-2016				69.25	3773.84
	10-Feb-2016				67.58	3775.51
	6-Nov-2015				68.60	3774.49
	6-Aug-2015				68.45	3774.64
	6-May-2015				69.22	3773.87
	6-Feb-2015				67.12	3775.97
	5-Nov-2014				68.47	3774.62
	12-Aug-2014				68.72	3774.37
	13-May-2014				68.35	3774.74
	14-Feb-2014				67.81	3775.28
	6-Nov-2013				68.06	3775.03
	6-Aug-2013				68.52	3774.57
	14-May-2013				67.09	3776.00
	7-Feb-2013				66.64	3776.45
	26-Oct-2012				67.17	3775.92
	1-Aug-2012				66.47	3776.62
	24-Apr-2012				65.84	3777.25
	30-Jan-2012				64.58	3778.51
	9-Dec-2011				64.65	3778.44
18-Jul-2011	65.79	3777.30				
19-Apr-2011	64.32	3778.77				
18-Jan-2011	62.49	3780.60				
1-Oct-2010	63.83	3779.26				
30-Jun-2010	63.71	3779.38				
22-Mar-2010	62.45	3780.64				
9-Dec-2009	62.57	3780.52				
28-Aug-2009	63.42	3779.67				
26-May-2009	64.03	3779.06				
11-Dec-2008	61.83	3781.26				
28-Sep-2008	63.42	3779.67				
11-Jun-2008	63.40	3779.69				
6-Feb-2008	62.02	3781.07				
14-Nov-2007	63.25	3779.84				
13-Sep-2007	64.02	3779.07				

**TABLE 1. SUMMARY OF MONITORING WELL FLUID GAUGING DATA
DONA ANA DAIRIES, DONA ANA COUNTY, NEW MEXICO**

Monitoring Well	Date Measured	Northing ^a	Easting ^a	Casing Elevation ^b	Depth to Water ^c	Ground Water Elevation ^b
692-09	4-May-2023	373575.83	1532395.09	3856.32	85.36	3770.96
	7-Feb-2023				84.52	3771.80
	4-Nov-2022				85.42	3770.90
	5-Aug-2022				85.51	3770.81
	4-May-2022				84.85	3771.47
	10-Feb-2022				84.12	3772.20
	3-Nov-2021				85.08	3771.24
	6-Aug-2021				84.81	3771.51
	5-May-2021				84.40	3771.92
	12-Feb-2021				83.68	3772.64
	4-Nov-2020				84.35	3771.97
	12-Aug-2020				84.09	3772.23
	12-May-2020				84.32	3772.00
	6-Feb-2020				84.02	3772.30
	7-Nov-2019				84.88	3771.44
	2-Aug-2019				84.52	3771.80
	9-May-2019				84.57	3771.75
	20-Feb-2019				83.87	3772.45
	13-Nov-2018				85.10	3771.22
	7-Aug-2018				85.15	3771.17
	17-May-2018				84.89	3771.43
	6-Feb-2018				83.45	3772.87
	7-Nov-2017				84.44	3771.88
	9-Aug-2017				84.85	3771.47
	16-May-2017				84.95	3771.37
	7-Feb-2017				83.68	3772.64
	8-Nov-2016				85.20	3771.12
	16-Aug-2016				85.13	3771.19
	17-May-2016				84.55	3771.77
	10-Feb-2016				83.56	3772.76
	6-Nov-2015				84.47	3771.85
	13-Aug-2015				84.35	3771.97
	6-May-2015				85.04	3771.28
	6-Feb-2015				83.34	3772.98
	10-Nov-2014				83.56	3772.76
	14-Aug-2014				84.03	3772.29
	13-May-2014				83.59	3772.73
	17-Feb-2014				82.51	3773.81
	6-Nov-2013				83.73	3772.59
	6-Aug-2013				83.40	3772.92
7-May-2013	82.64	3773.68				
7-Feb-2013	82.02	3774.30				
26-Oct-2012	82.18	3774.14				
1-Aug-2012	82.11	3774.21				
24-Apr-2012	81.17	3775.15				
25-Jan-2012	79.80	3776.52				
8-Dec-2011	80.44	3775.88				
18-Jul-2011	80.78	3775.54				
19-Apr-2011	79.65	3776.67				
17-Jan-2011	78.52	3777.80				
15-Sep-2010	79.33	3776.99				
30-Jun-2010	79.52	3776.80				
22-Mar-2010	78.13	3778.19				
9-Dec-2009	78.79	3777.53				
28-Aug-2009	79.48	3776.84				
26-May-2009	78.89	3777.43				
11-Dec-2008	78.11	3778.21				
28-Sep-2008	78.55	3777.77				
11-Jun-2008	79.03	3777.29				
6-Feb-2008	78.16	3778.16				
14-Nov-2007	79.15	3777.17				
13-Sep-2007	79.93	3776.39				

**TABLE 1. SUMMARY OF MONITORING WELL FLUID GAUGING DATA
DONA ANA DAIRIES, DONA ANA COUNTY, NEW MEXICO**

Monitoring Well	Date Measured	Northing ^a	Easting ^a	Casing Elevation ^b	Depth to Water ^c	Ground Water Elevation ^b
692-10	7-May-2023	374957.71	1531695.32	3847.51	75.25	3772.26
	7-Feb-2023				74.66	3772.85
	4-Nov-2022				75.31	3772.20
Anthony Waste Water Treatment Plant						
MW-1	4-May-2023	372097.86	1532364.36	3843.03	65.40	3777.63
	7-Feb-2023				65.42	3777.61
	4-Nov-2022				65.10	3777.93
	5-Aug-2022				64.82	3778.21
	4-May-2022				64.62	3778.41
	10-Feb-2022				64.46	3778.57
	3-Nov-2021				64.30	3778.73
	9-Aug-2021				64.02	3779.01
	5-May-2021				63.67	3779.36
	12-Feb-2021				63.13	3779.90
	4-Nov-2020				62.77	3780.26
	12-Aug-2020				62.42	3780.61
	14-May-2020				62.00	3781.03
	6-Feb-2020				61.40	3781.63
	7-Nov-2019				61.93	3781.10
	3-Aug-2019				62.31	3780.72
	9-May-2019				62.12	3780.91
	1-Mar-2019				61.86	3781.17
	13-Nov-2018				61.53	3781.50
	15-Aug-2018				61.59	3781.44
	17-May-2018				61.56	3781.47
	13-Feb-2018				61.22	3781.81
	9-Nov-2017				61.06	3781.97
	10-Aug-2017				61.15	3781.88
	19-May-2017				61.24	3781.79
	7-Feb-2017				60.95	3782.08
	10-Nov-2016				60.91	3782.12
	16-Aug-2016				61.38	3781.65
	17-May-2016				61.40	3781.63
	11-Feb-2016				61.40	3781.63
	11-Nov-2015				61.08	3781.95
	7-Aug-2015				60.85	3782.18
	7-May-2015				61.27	3781.76
6-Feb-2015	60.96	3782.07				
6-Nov-2014	60.79	3782.24				
12-Aug-2014	60.73	3782.30				
13-May-2014	60.65	3782.38				
14-Feb-2014	60.49	3782.54				
7-Nov-2013	60.28	3782.75				
7-Aug-2013	60.13	3782.90				
8-May-2013	59.72	3783.31				
7-Feb-2013	59.23	3783.80				
26-Oct-2012	58.85	3784.18				
2-Aug-2012	58.79	3784.24				
25-Apr-2012	58.28	3784.75				
9-Dec-2011	58.01	3785.02				
18-Jul-2011	58.44	3784.59				
20-Apr-2011	58.35	3784.68				
18-Jan-2011	58.20	3784.83				
15-Sep-2010	58.28	3784.75				
24-Jun-2010	58.50	3784.53				
22-Mar-2010	58.43	3784.60				
9-Dec-2009	58.15	3784.88				
28-Aug-2009	58.07	3784.96				
27-May-2009	58.41	3784.62				

**TABLE 1. SUMMARY OF MONITORING WELL FLUID GAUGING DATA
DONA ANA DAIRIES, DONA ANA COUNTY, NEW MEXICO**

Monitoring Well	Date Measured	Northing ^a	Easting ^a	Casing Elevation ^b	Depth to Water ^c	Ground Water Elevation ^b
MW-2	4-May-2023	NM	NM	3843.25	66.88	3776.37
	7-Feb-2023				67.00	3776.25
	4-Nov-2022				66.78	3776.47
	5-Aug-2022				66.42	3776.83
	4-May-2022				66.12	3777.13
	10-Feb-2022				66.03	3777.22
	3-Nov-2021				65.88	3777.37
	9-Aug-2021				65.55	3777.70
	5-May-2021				65.10	3778.15
	12-Feb-2021				64.77	3778.48
	4-Nov-2020				64.09	3779.16
	12-Aug-2020				63.38	3779.87
	13-May-2020				62.80	3780.45
	6-Feb-2020				61.91	3781.34
	7-Nov-2019				62.32	3780.93
	3-Aug-2019				62.97	3780.28
	9-May-2019				63.02	3780.23
	1-Mar-2019				62.62	3780.63
	13-Nov-2018				62.04	3781.21
	15-Aug-2018				61.96	3781.29
	17-May-2018				62.65	3780.60
	13-Feb-2018				62.47	3780.78
	9-Nov-2017				62.20	3781.05
	10-Aug-2017				62.26	3780.99
	19-May-2017				62.32	3780.93
	7-Feb-2017				62.20	3781.05
	10-Nov-2016				61.82	3781.43
	16-Aug-2016				62.34	3780.91
	17-May-2016				62.67	3780.58
	11-Feb-2016				62.73	3780.52
	11-Nov-2015				62.30	3780.95
	7-Aug-2015				62.05	3781.20
	7-May-2015				62.66	3780.59
	6-Feb-2015				62.48	3780.77
	6-Nov-2014				62.22	3781.03
	12-Aug-2014				62.09	3781.16
	13-May-2014				62.06	3781.19
	14-Feb-2014				62.04	3781.21
	7-Nov-2013				61.81	3781.44
	7-Aug-2013				62.07	3781.18
8-May-2013	61.21	3782.04				
7-Feb-2013	60.85	3782.40				
26-Oct-2012	60.42	3782.83				
2-Aug-2012	60.30	3782.95				
25-Apr-2012	59.94	3783.31				
30-Jan-2012	59.30	3783.95				
9-Dec-2011	59.33	3783.92				
18-Jul-2011	59.41	3783.84				
20-Apr-2011	59.42	3783.83				
18-Jan-2011	59.31	3783.94				
15-Sep-2010	59.08	3784.17				
24-Jun-2010	59.37	3783.88				
22-Mar-2010	59.44	3783.81				
9-Dec-2009	59.19	3784.06				
28-Aug-2009	58.98	3784.27				
27-May-2009	59.45	3783.80				

**TABLE 1. SUMMARY OF MONITORING WELL FLUID GAUGING DATA
DONA ANA DAIRIES, DONA ANA COUNTY, NEW MEXICO**

Monitoring Well	Date Measured	Northing ^a	Easting ^a	Casing Elevation ^b	Depth to Water ^c	Ground Water Elevation ^b
MW-3	4-May-2023	NM	NM	3841.24	59.26	3781.98
	7-Feb-2023				59.50	3781.74
	4-Nov-2022				59.42	3781.82
	5-Aug-2022				59.05	3782.19
	4-May-2022				58.67	3782.57
	10-Feb-2022				58.45	3782.79
	3-Nov-2021				58.60	3782.64
	9-Aug-2021				58.41	3782.83
	5-May-2021				58.02	3783.22
	12-Feb-2021				57.72	3783.52
	4-Nov-2020				57.50	3783.74
	12-Aug-2020				57.09	3784.15
	14-May-2020				56.34	3784.90
	6-Feb-2020				55.37	3785.87
	7-Nov-2019				55.49	3785.87
	3-Aug-2019				56.65	3784.59
	9-May-2019				57.05	3784.19
	1-Mar-2019				57.18	3784.06
	13-Nov-2018				57.09	3784.15
	15-Aug-2018				57.02	3784.22
	17-May-2018					Dry
	13-Feb-2018					Dry
	9-Nov-2017					Dry
	10-Aug-2017					Dry
	19-May-2017					Dry
	7-Feb-2017					Dry
	10-Nov-2016					Dry
	16-Aug-2016					Dry
	17-May-2016					Dry
	11-Feb-2016					Dry
	11-Nov-2015					Dry
	7-Aug-2015					Dry
	7-May-2015					Dry
	6-Feb-2015					Dry
	6-Nov-2014					Dry
	12-Aug-2014					Dry
	13-May-2014					Dry
	14-Feb-2014					Dry
	7-Nov-2013					Dry
	7-Aug-2013				59.29	3781.95
	8-May-2013				58.80	3782.44
	7-Feb-2013				58.36	3782.88
26-Oct-2012	57.98	3783.26				
2-Aug-2012	57.81	3783.43				
25-Apr-2012	57.32	3783.92				
30-Jan-2012	56.80	3784.44				
8-Dec-2011	56.87	3784.37				
18-Jul-2011	56.98	3784.26				
19-Apr-2011	56.93	3784.31				
18-Jan-2011	56.73	3784.51				
15-Sep-2010		Could not access				
24-Jun-2010	56.91	3784.33				
22-Mar-2010	56.93	3784.31				
9-Dec-2009	56.69	3784.55				
28-Aug-2009	56.54	3784.70				
27-May-2009	56.96	3784.28				

**TABLE 1. SUMMARY OF MONITORING WELL FLUID GAUGING DATA
DONA ANA DAIRIES, DONA ANA COUNTY, NEW MEXICO**

Monitoring Well	Date Measured	Northing ^a	Easting ^a	Casing Elevation ^b	Depth to Water ^c	Ground Water Elevation ^b
ABATEMENT PLAN MONITOR WELLS						
DAD-01	1-May-2023	422970.59	1512825.76	3886.16	74.84	3811.32
	2-Feb-2023				74.10	3812.06
	1-Nov-2022				74.85	3811.31
	1-Aug-2022				75.05	3811.11
	2-May-2022				74.15	3812.01
	7-Feb-2022				73.26	3812.90
	1-Nov-2021				73.82	3812.34
	4-Aug-2021				73.66	3812.50
	3-May-2021				73.11	3813.05
	10-Feb-2021				72.87	3813.29
	2-Nov-2020				73.18	3812.98
	10-Aug-2020				73.70	3812.46
	11-May-2020				73.66	3812.50
	4-Feb-2020				72.46	3813.70
	8-Nov-2019				73.11	3813.05
	1-Aug-2019				74.05	3812.11
	9-May-2019				73.59	3812.57
	19-Feb-2019				72.51	3813.65
	12-Nov-2018				72.84	3813.32
	6-Aug-2018				73.70	3812.46
	17-May-2018				73.38	3812.78
	5-Feb-2018				71.87	3814.29
	6-Nov-2017				72.81	3813.35
	7-Aug-2017				73.66	3812.50
	15-May-2017				73.69	3812.47
	7-Feb-2017				72.38	3813.78
	8-Nov-2016				73.39	3812.77
	16-Aug-2016				74.02	3812.14
	17-May-2016				73.90	3812.26
	10-Feb-2016				72.32	3813.84
	6-Nov-2015				73.00	3813.16
	6-Aug-2015				73.54	3812.62
	7-May-2015				72.98	3813.18
	6-Feb-2015				71.45	3814.71
	6-Nov-2014				72.07	3814.09
	12-Aug-2014				71.93	3814.23
	13-May-2014				71.48	3814.68
	12-Feb-2014				70.14	3816.02
	6-Nov-2013				70.64	3815.52
	7-Aug-2013				68.63	3817.53
7-May-2013	68.48	3817.68				
8-Feb-2013	68.59	3817.57				
29-Oct-2012	68.12	3818.04				
30-Jul-2012	68.97	3817.19				
23-Apr-2012	68.19	3817.97				
25-Jan-2012	67.15	3819.01				
8-Dec-2011	67.41	3818.75				
19-Jul-2011	67.41	3818.75				
25-Apr-2011	65.86	3820.30				
18-Jan-2011	65.37	3820.79				
16-Sep-2010	65.86	3820.30				
24-Jun-2010	66.58	3819.58				
21-Mar-2010	65.46	3820.70				
9-Dec-2009	65.32	3820.84				
29-Aug-2009	65.68	3820.48				
26-May-2009	65.43	3820.73				

**TABLE 1. SUMMARY OF MONITORING WELL FLUID GAUGING DATA
DONA ANA DAIRIES, DONA ANA COUNTY, NEW MEXICO**

Monitoring Well	Date Measured	Northing ^a	Easting ^a	Casing Elevation ^b	Depth to Water ^c	Ground Water Elevation ^b
DAD-02	3-May-2023	413002.98	1517319.93	3875.82	68.40	3807.42
	3-Feb-2023				67.90	3807.92
	3-Nov-2022				68.08	3807.74
	4-Aug-2022				67.91	3807.91
	3-May-2022				67.38	3808.44
	8-Feb-2022				66.87	3808.95
	2-Nov-2021				67.30	3808.52
	5-Aug-2021				66.92	3808.90
	4-May-2021				66.46	3809.36
	11-Feb-2021				66.19	3809.63
	3-Nov-2020				66.83	3808.99
	11-Aug-2020				67.11	3808.71
	11-May-2020				67.75	3808.07
	5-Feb-2020				66.20	3809.62
	8-Nov-2019				65.05	3810.77
	1-Aug-2019				66.91	3808.91
	8-May-2019				66.46	3809.36
	19-Feb-2019				65.90	3809.92
	12-Nov-2018				66.40	3809.42
	6-Aug-2018				66.42	3809.40
	17-May-2018				66.10	3809.72
	5-Feb-2018				65.63	3810.19
	6-Nov-2017				66.21	3809.61
	7-Aug-2017				66.75	3809.07
	16-May-2017				66.74	3809.08
	7-Feb-2017				66.41	3809.41
	8-Nov-2016				67.08	3808.74
	16-Aug-2016				67.55	3808.27
	17-May-2016				67.30	3808.52
	10-Feb-2016				66.83	3808.99
	6-Nov-2015				67.21	3808.61
	6-Aug-2015				67.25	3808.57
	7-May-2015				67.10	3808.72
	6-Feb-2015				66.30	3809.52
	6-Nov-2014				66.60	3809.22
	12-Aug-2014				66.55	3809.27
	13-May-2014				66.01	3809.81
	12-Feb-2014				65.42	3810.40
	7-Nov-2013				65.55	3810.27
	7-Aug-2013				65.01	3810.81
8-May-2013	64.56	3811.26				
8-Feb-2013	64.04	3811.78				
29-Oct-2012	64.11	3811.71				
31-Jul-2012	64.03	3811.79				
24-Apr-2012	63.45	3812.37				
25-Jan-2012	62.91	3812.91				
8-Dec-2011	63.07	3812.75				
19-Jul-2011	62.63	3813.19				
18-Apr-2011	62.11	3813.71				
17-Jan-2011	61.37	3814.45				
16-Sep-2010	61.79	3814.03				
25-Jun-2010	62.95	3812.87				
21-Mar-2010	61.43	3814.39				
9-Dec-2009	61.46	3814.36				
29-Aug-2009	61.65	3814.17				
26-May-2009	61.59	3814.23				

**TABLE 1. SUMMARY OF MONITORING WELL FLUID GAUGING DATA
DONA ANA DAIRIES, DONA ANA COUNTY, NEW MEXICO**

Monitoring Well	Date Measured	Northing ^a	Easting ^a	Casing Elevation ^b	Depth to Water ^c	Ground Water Elevation ^b
DAD-03	3-May-2023	407721.31	1516497.85	3820.58	15.97	3804.61
	3-Feb-2023				15.21	3805.37
	3-Nov-2022				15.30	3805.28
	4-Aug-2022				15.08	3805.50
	3-May-2022				14.50	3806.08
	8-Feb-2022				13.71	3806.87
	2-Nov-2021				14.16	3806.42
	5-Aug-2021				13.80	3806.78
	4-May-2021				13.10	3807.48
	11-Feb-2021				12.35	3808.23
	3-Nov-2020				12.61	3807.97
	11-Aug-2020				12.67	3807.91
	11-May-2020				12.89	3807.69
	5-Feb-2020				12.57	3808.01
	7-Nov-2019				12.21	3808.37
	1-Aug-2019				13.50	3807.08
	9-May-2019				13.29	3807.29
	19-Feb-2019				12.45	3808.13
	12-Nov-2018				12.55	3808.03
	7-Aug-2018				12.38	3808.20
	17-May-2018				12.41	3808.17
	5-Feb-2018				11.55	3809.03
	7-Nov-2017				11.62	3808.96
	9-Aug-2017				12.47	3808.11
	16-May-2017				13.31	3807.27
	7-Feb-2017				12.50	3808.08
	8-Nov-2016				NM	NM
	17-Aug-2016				13.12	3807.46
	20-May-2016				13.82	3806.76
	10-Feb-2016				13.07	3807.51
	6-Nov-2015				13.20	3807.38
	6-Aug-2015				13.41	3807.17
	7-May-2015				13.52	3807.06
	6-Feb-2015				12.87	3807.71
	6-Nov-2014				12.94	3807.64
	12-Aug-2014				13.20	3807.38
	13-May-2014				13.39	3807.19
	17-Feb-2014				12.66	3807.92
	11-Dec-2013				12.67	3807.91
	14-Aug-2013				12.36	3808.22
	8-May-2013				11.87	3808.71
8-Feb-2013	11.07	3809.51				
29-Oct-2012	10.93	3809.65				
31-Jul-2012	10.90	3809.68				
24-Apr-2012	10.97	3809.61				
25-Jan-2012	10.60	3809.98				
8-Dec-2011	10.70	3809.88				
19-Jul-2011	10.29	3810.29				
18-Apr-2011	10.12	3810.46				
24-Jan-2011	9.36	3811.22				
16-Sep-2010	9.40	3811.18				
24-Jun-2010	9.97	3810.61				
21-Mar-2010	9.90	3810.68				
9-Dec-2009	9.79	3810.79				
29-Aug-2009	9.72	3810.86				
26-May-2009	9.89	3810.69				

**TABLE 1. SUMMARY OF MONITORING WELL FLUID GAUGING DATA
DONA ANA DAIRIES, DONA ANA COUNTY, NEW MEXICO**

Monitoring Well	Date Measured	Northing ^a	Easting ^a	Casing Elevation ^b	Depth to Water ^c	Ground Water Elevation ^b
DAD-04	3-May-2023	404576.66	1517413.28	3821.47	DRY	
	6-Feb-2023				DRY	
	3-Nov-2022				18.15	3803.32
	4-Aug-2022				17.87	3803.60
	3-May-2022				17.22	3804.25
	8-Feb-2022				17.05	3804.42
	2-Nov-2021				17.93	3803.54
	6-Aug-2021				18.10	3803.37
	4-May-2021				16.26	3805.21
	11-Feb-2021				15.86	3805.61
	3-Nov-2020				16.10	3805.37
	11-Aug-2020				16.68	3804.79
	12-May-2020				16.78	3804.69
	5-Feb-2020				15.70	3805.77
	8-Nov-2019				16.87	3804.60
	1-Aug-2019				17.14	3804.33
	9-May-2019				17.82	3803.65
	19-Feb-2019				15.85	3805.62
	12-Nov-2018				16.15	3805.32
	7-Aug-2018				15.76	3805.71
	17-May-2018				16.66	3804.81
	6-Feb-2018				14.44	3807.03
	6-Nov-2017				14.49	3806.98
	7-Aug-2017				15.55	3805.92
	16-May-2017				17.58	3803.89
	7-Feb-2017				15.59	3805.88
	8-Nov-2016				15.57	3805.90
	16-Aug-2016				16.15	3805.32
	17-May-2016				17.20	3804.27
	10-Feb-2016				15.21	3806.26
	6-Nov-2015				15.98	3805.49
	6-Aug-2015				16.77	3804.70
	7-May-2015				17.57	3803.90
	6-Feb-2015				15.55	3805.92
	6-Nov-2014				15.29	3806.18
	13-Aug-2014				15.81	3805.66
	13-May-2014				17.36	3804.11
	13-Feb-2014				15.45	3806.02
	7-Nov-2013				16.91	3804.56
	7-Aug-2013				17.11	3804.36
	8-May-2013				15.02	3806.45
8-Feb-2013	14.48	3806.99				
29-Oct-2012	15.10	3806.37				
31-Jul-2012	14.37	3807.10				
24-Apr-2012	14.27	3807.20				
25-Jan-2012	13.40	3808.07				
8-Dec-2011	13.84	3807.63				
19-Jul-2011	13.63	3807.84				
18-Apr-2011	13.21	3808.26				
17-Jan-2011	12.71	3808.76				
16-Sep-2010	12.14	3809.33				
23-Jun-2010	12.59	3808.88				
21-Mar-2010	12.88	3808.59				
9-Dec-2009	12.10	3809.37				
29-Aug-2009	12.13	3809.34				
26-May-2009	12.31	3809.16				

**TABLE 1. SUMMARY OF MONITORING WELL FLUID GAUGING DATA
DONA ANA DAIRIES, DONA ANA COUNTY, NEW MEXICO**

Monitoring Well	Date Measured	Northing ^a	Easting ^a	Casing Elevation ^b	Depth to Water ^c	Ground Water Elevation ^b
DAD-05	4-May-2023	396712.87	1519102.06	3816.01	16.83	3799.18
	7-Feb-2023				16.74	3799.27
	4-Nov-2022				16.03	3799.98
	5-Aug-2022				15.37	3800.64
	4-May-2022				15.78	3800.23
	9-Feb-2022				16.32	3799.69
	3-Nov-2021				16.21	3799.80
	6-Aug-2021				15.55	3800.46
	4-May-2021				15.42	3800.59
	12-Feb-2021				14.88	3801.13
	4-Nov-2020				15.16	3800.85
	12-Aug-2020				14.93	3801.08
	12-May-2020				15.60	3800.41
	6-Feb-2020				15.30	3800.71
	8-Nov-2019				15.51	3800.50
	2-Aug-2019				14.21	3801.80
	9-May-2019				16.19	3799.82
	19-Feb-2019				15.65	3800.36
	13-Nov-2018				15.28	3800.73
	7-Aug-2018				14.25	3801.76
	14-May-2018				15.45	3800.56
	6-Feb-2018				14.95	3801.06
	7-Nov-2017				13.75	3802.26
	7-Aug-2017				13.70	3802.31
	16-May-2017				15.96	3800.05
	7-Feb-2017				15.86	3800.15
	8-Nov-2016				15.46	3800.55
	16-Aug-2016				14.28	3801.73
	17-May-2016				16.85	3799.16
	10-Feb-2016				16.55	3799.46
	6-Nov-2015				16.57	3799.44
	13-Aug-2015				14.38	3801.63
	7-May-2015				18.16	3797.85
	6-Feb-2015				16.60	3799.41
	10-Nov-2014				17.25	3798.76
	13-Aug-2014				14.33	3801.68
	13-May-2014				17.24	3798.77
	13-Feb-2014				15.82	3800.19
	7-Nov-2013				15.39	3800.62
	7-Aug-2013				15.32	3800.69
8-May-2013	15.78	3800.23				
8-Feb-2013	15.08	3800.93				
29-Oct-2012	14.85	3801.16				
2-Aug-2012	14.17	3801.84				
24-Apr-2012	14.14	3801.87				
25-Jan-2012	14.11	3801.90				
8-Dec-2011	14.05	3801.96				
18-Jul-2011	12.31	3803.70				
18-Apr-2011	12.58	3803.43				
17-Jan-2011	12.50	3803.51				
16-Sep-2010	11.87	3804.14				
23-Jun-2010	12.95	3803.06				
21-Mar-2010	12.92	3803.09				
9-Dec-2009	12.13	3803.88				
29-Aug-2009	11.85	3804.16				
26-May-2009	12.07	3803.94				

**TABLE 1. SUMMARY OF MONITORING WELL FLUID GAUGING DATA
DONA ANA DAIRIES, DONA ANA COUNTY, NEW MEXICO**

Monitoring Well	Date Measured	Northing ^a	Easting ^a	Casing Elevation ^b	Depth to Water ^c	Ground Water Elevation ^b
DAD-06	4-Nov-2022	404273.19	1522081.00	3887.71	Plugged and Abandoned	
	4-May-2022				Dry	
	4-May-2022				Dry	
	9-Feb-2022				Dry	
	2-Nov-2021				Dry	
	5-Aug-2021				Dry	
	4-May-2021				Dry	
	11-Feb-2021				Dry	
	3-Nov-2020				Dry	
	11-Aug-2020				Dry	
	12-May-2020				Dry	
	5-Feb-2020				Dry	
	8-Nov-2019				Dry	
	5-Aug-2019				Dry	
	9-May-2019				Dry	
	14-Mar-2019				Dry	
	13-Nov-2018				Dry	
	7-Aug-2018				Dry	
	17-May-2018				Dry	
	6-Feb-2018				Dry	
	6-Nov-2017				Dry	
	7-Aug-2017				Dry	
	16-May-2017				Dry	
	7-Feb-2017				Dry	
	8-Nov-2016				Dry	
	16-Aug-2016				Dry	
	17-May-2016				Dry	
	10-Feb-2016				Dry	
	6-Nov-2015				Dry	
	6-Aug-2015				Dry	
	7-May-2015				Dry	
	6-Feb-2015				Dry	
	6-Nov-2014				Dry	
	12-Aug-2014				Dry	
	13-May-2014				Dry	
	13-Feb-2014				Dry	
	7-Nov-2013				Dry	
	7-Aug-2013				Dry	
	8-May-2013				82.79	3804.92
	8-Feb-2013				82.38	3805.33
29-Oct-2012	82.47	3805.24				
1-Aug-2012	82.20	3805.51				
24-Apr-2012	82.13	3805.58				
25-Jan-2012	81.32	3806.39				
8-Dec-2011	81.55	3806.16				
18-Jul-2011	80.94	3806.77				
20-Apr-2011	80.16	3807.55				
17-Jan-2011	79.43	3808.28				
16-Sep-2010	79.68	3808.03				
25-Jun-2010	80.33	3807.38				
21-Mar-2010	79.85	3807.86				
9-Dec-2009	79.95	3807.76				
29-Aug-2009	80.46	3807.25				
26-May-2009	80.32	3807.39				
DAD-06R	3-May-2023	404287.43	1522077.30	3887.80	85.90	3801.90
	6-Feb-2023				85.55	3802.25
	7-Nov-2022				85.70	3802.10

**TABLE 1. SUMMARY OF MONITORING WELL FLUID GAUGING DATA
DONA ANA DAIRIES, DONA ANA COUNTY, NEW MEXICO**

Monitoring Well	Date Measured	Northing ^a	Easting ^a	Casing Elevation ^b	Depth to Water ^c	Ground Water Elevation ^b
DAD-07	3-May-2023	399270.18	1524320.88	3891.38	93.15	3798.23
	7-Feb-2023				93.08	3798.30
	4-Nov-2022				93.10	3798.28
	5-Aug-2022				92.92	3798.46
	4-May-2022				92.63	3798.75
	9-Feb-2022				92.40	3798.98
	3-Nov-2021				91.88	3799.50
	6-Aug-2021				91.10	3800.28
	5-May-2021				92.24	3799.14
	12-Feb-2021				92.06	3799.32
	4-Nov-2020				92.50	3798.88
	12-Aug-2020				92.10	3799.28
	12-May-2020				92.56	3798.82
	6-Feb-2020				92.36	3799.02
	7-Nov-2019				92.70	3798.68
	2-Aug-2019				92.67	3798.71
	9-May-2019				92.67	3798.71
	9-May-2019				90.29	3801.09
	20-Feb-2019				92.24	3799.14
	13-Nov-2018				92.59	3798.79
	7-Aug-2018				92.45	3798.93
	14-May-2018				92.27	3799.11
	5-Feb-2018				92.16	3799.22
	6-Nov-2017				92.47	3798.91
	7-Aug-2017				92.72	3798.66
	15-May-2017				92.61	3798.77
	7-Feb-2017				92.40	3798.98
	8-Nov-2016				93.77	3797.61
	16-Aug-2016				92.94	3798.44
	17-May-2016				92.81	3798.57
	10-Feb-2016				92.64	3798.74
	6-Nov-2015				92.59	3798.79
	6-Aug-2015				92.43	3798.95
	7-May-2015				92.46	3798.92
	6-Feb-2015				92.28	3799.10
	6-Nov-2014				92.34	3799.04
	12-Aug-2014				92.12	3799.26
	13-May-2014				91.88	3799.50
	13-Feb-2014				91.37	3800.01
	7-Nov-2013				91.60	3799.78
	7-Aug-2013				91.19	3800.19
	8-May-2013				90.89	3800.49
8-Feb-2013	90.13	3801.25				
29-Oct-2012	90.34	3801.04				
2-Aug-2012	90.38	3801.00				
24-Apr-2012	90.25	3801.13				
25-Jan-2012	89.75	3801.63				
8-Dec-2011	89.35	3802.03				
18-Jul-2011	88.98	3802.40				
20-Apr-2011	88.34	3803.04				
17-Jan-2011	87.94	3803.44				
16-Sep-2010	88.29	3803.09				
25-Jun-2010	88.49	3802.89				
21-Mar-2010	88.00	3803.38				
9-Dec-2009	88.19	3803.19				
29-Aug-2009	88.45	3802.93				
26-May-2009	88.14	3803.24				

**TABLE 1. SUMMARY OF MONITORING WELL FLUID GAUGING DATA
DONA ANA DAIRIES, DONA ANA COUNTY, NEW MEXICO**

Monitoring Well	Date Measured	Northing ^a	Easting ^a	Casing Elevation ^b	Depth to Water ^c	Ground Water Elevation ^b
DAD-08	4-May-2023	395287.38	1522575.07	3849.15	53.10	3796.05
	7-Feb-2023				52.80	3796.35
	4-Nov-2022				53.18	3795.97
	5-Aug-2022				53.40	3795.75
	4-May-2022				52.74	3796.41
	9-Feb-2022				51.83	3797.32
	3-Nov-2021				52.60	3796.55
	6-Aug-2021				52.90	3796.25
	5-May-2021				51.89	3797.26
	12-Feb-2021				51.00	3798.15
	4-Nov-2020				51.32	3797.83
	12-Aug-2020				50.89	3798.26
	12-May-2020				51.55	3797.60
	6-Feb-2020				50.99	3798.16
	8-Nov-2019				50.31	3798.84
	2-Aug-2019				51.90	3797.25
	9-May-2019				51.68	3797.47
	20-Feb-2019				50.77	3798.38
	13-Nov-2018				51.58	3797.57
	7-Aug-2018				51.70	3797.45
	14-May-2018				52.20	3796.95
	6-Feb-2018				50.88	3798.27
	7-Nov-2017				51.15	3798.00
	7-Aug-2017				51.71	3797.44
	16-May-2017				52.95	3796.20
	7-Feb-2017				51.74	3797.41
	8-Nov-2016				52.45	3796.70
	16-Aug-2016				52.89	3796.26
	17-May-2016				53.80	3795.35
	10-Feb-2016				52.64	3796.51
	6-Nov-2015				53.04	3796.11
	6-Aug-2015				52.90	3796.25
	7-May-2015				53.22	3795.93
	6-Feb-2015				51.97	3797.18
	6-Nov-2014				52.61	3796.54
	13-Aug-2014				53.09	3796.06
	13-May-2014				53.98	3795.17
	13-Feb-2014				51.31	3797.84
	7-Nov-2013				51.50	3797.65
	7-Aug-2013				53.18	3795.97
8-May-2013	52.43	3796.72				
8-Feb-2013	50.37	3798.78				
29-Oct-2012	49.86	3799.29				
1-Aug-2012	50.34	3798.81				
24-Apr-2012	50.34	3798.81				
25-Jan-2012	49.62	3799.53				
13-Dec-2011	50.12	3799.03				
18-Jul-2011	49.97	3799.18				
20-Apr-2011	48.87	3800.28				
18-Jan-2011	47.80	3801.35				
17-Sep-2010	47.05	3802.10				
25-Jun-2010	48.06	3801.09				
21-Mar-2010	47.76	3801.39				
9-Dec-2009	47.42	3801.73				
29-Aug-2009	47.18	3801.97				
26-May-2009	47.38	3801.77				

**TABLE 1. SUMMARY OF MONITORING WELL FLUID GAUGING DATA
DONA ANA DAIRIES, DONA ANA COUNTY, NEW MEXICO**

Monitoring Well	Date Measured	Northing ^a	Easting ^a	Casing Elevation ^b	Depth to Water ^c	Ground Water Elevation ^b
DAD-09	4-May-2023	373259.30	1530905.70	3838.03	57.21	3780.82
	7-Feb-2023				57.03	3781.00
	4-Nov-2022				56.76	3781.27
	5-Aug-2022				56.22	3781.81
	4-May-2022				55.40	3782.63
	10-Feb-2022				54.53	3783.50
	3-Nov-2021				55.25	3782.78
	6-Aug-2021				55.76	3782.27
	5-May-2021				55.78	3782.25
	12-Feb-2021				55.66	3782.37
	4-Nov-2020				55.94	3782.09
	12-Aug-2020				55.90	3782.13
	12-May-2020				55.75	3782.28
	6-Feb-2020				54.85	3783.18
	8-Nov-2019				54.31	3783.72
	2-Aug-2019				55.00	3783.03
	9-May-2019				55.99	3782.04
	20-Feb-2019				57.75	3780.28
	13-Nov-2018				58.15	3779.88
	7-Aug-2018				58.32	3779.71
	14-May-2018				58.25	3779.78
	6-Feb-2018				58.10	3779.93
	7-Nov-2017				58.28	3779.75
	9-Aug-2017				58.73	3779.30
	16-May-2017				58.56	3779.47
	7-Feb-2017				58.25	3779.78
	8-Nov-2016				58.46	3779.57
	16-Aug-2016				58.28	3779.75
	17-May-2016				57.91	3780.12
	10-Feb-2016				57.75	3780.28
	6-Nov-2015				57.46	3780.57
	6-Aug-2015				57.36	3780.67
	7-May-2015				57.19	3780.84
	6-Feb-2015				56.90	3781.13
	6-Nov-2014				56.69	3781.34
	12-Aug-2014				56.57	3781.46
	13-May-2014				56.14	3781.89
	13-Feb-2014				55.65	3782.38
	7-Nov-2013				55.17	3782.86
	7-Aug-2013				55.35	3782.68
	7-May-2013				54.94	3783.09
	8-Feb-2013				54.67	3783.36
29-Oct-2012	54.13	3783.90				
2-Aug-2012	53.86	3784.17				
24-Apr-2012	53.40	3784.63				
25-Jan-2012	52.67	3785.36				
13-Dec-2011	52.62	3785.41				
18-Jul-2011	52.28	3785.75				
18-Apr-2011	51.89	3786.14				
17-Jan-2011	51.09	3786.94				
17-Sep-2010	51.55	3786.48				
29-Jun-2010	52.20	3785.83				
21-Mar-2010	51.84	3786.19				
9-Dec-2009	52.12	3785.91				
29-Aug-2009	52.23	3785.80				
26-May-2009	52.49	3785.54				

**TABLE 1. SUMMARY OF MONITORING WELL FLUID GAUGING DATA
DONA ANA DAIRIES, DONA ANA COUNTY, NEW MEXICO**

Monitoring Well	Date Measured	Northing ^a	Easting ^a	Casing Elevation ^b	Depth to Water ^c	Ground Water Elevation ^b
DAD-10	4-May-2023	372980.55	1532375.33	3854.93	84.14	3770.79
	7-Feb-2023				83.45	3771.48
	4-Nov-2022				84.06	3770.87
	5-Aug-2022				84.64	3770.29
	4-May-2022				84.08	3770.85
	10-Feb-2022				83.25	3771.68
	3-Nov-2021				84.12	3770.81
	6-Aug-2021				83.97	3770.96
	5-May-2021				83.93	3771.00
	12-Feb-2021				83.01	3771.92
	4-Nov-2020				83.78	3771.15
	12-Aug-2020				83.10	3771.83
	12-May-2020				83.44	3771.49
	6-Feb-2020				82.95	3771.98
	7-Nov-2019				83.76	3771.17
	2-Aug-2019				83.38	3771.55
	9-May-2019				83.71	3771.22
	20-Feb-2019				82.71	3772.22
	13-Nov-2018				84.08	3770.85
	7-Aug-2018				84.45	3770.48
	17-May-2018				84.35	3770.58
	5-Feb-2018				82.54	3772.39
	6-Nov-2017				83.29	3771.64
	9-Aug-2017				83.76	3771.17
	16-May-2017				84.45	3770.48
	7-Feb-2017				82.58	3772.35
	8-Nov-2016				84.47	3770.46
	16-Aug-2016				84.45	3770.48
	17-May-2016				83.77	3771.16
	10-Feb-2016				82.52	3772.41
	6-Nov-2015				83.80	3771.13
	6-Aug-2015				83.56	3771.37
	7-May-2015				83.93	3771.00
	6-Feb-2015				82.18	3772.75
	6-Nov-2014				83.31	3771.62
	12-Aug-2014				83.25	3771.68
	13-May-2014				83.61	3771.32
	17-Feb-2014				81.59	3773.34
	7-Nov-2013				82.75	3772.18
	7-Aug-2013				82.78	3772.15
7-May-2013	81.77	3773.16				
8-Feb-2013	80.87	3774.06				
29-Oct-2012	81.02	3773.91				
2-Aug-2012	81.47	3773.46				
24-Apr-2012	80.36	3774.57				
25-Jan-2012	78.76	3776.17				
13-Dec-2011	79.07	3775.86				
18-Jul-2011	80.29	3774.64				
20-Apr-2011	79.13	3775.80				
17-Jan-2011	77.82	3777.11				
17-Sep-2010	78.66	3776.27				
29-Jun-2010	78.59	3776.34				
21-Mar-2010	77.19	3777.74				
9-Dec-2009	77.92	3777.01				
29-Aug-2009	78.72	3776.21				
26-May-2009	77.90	3777.03				

**TABLE 1. SUMMARY OF MONITORING WELL FLUID GAUGING DATA
DONA ANA DAIRIES, DONA ANA COUNTY, NEW MEXICO**

Monitoring Well	Date Measured	Northing ^a	Easting ^a	Casing Elevation ^b	Depth to Water ^c	Ground Water Elevation ^b
DAD-11 Vertical Delineation	2-May-2023	416211.35	1513814.71	3835.90	24.19	3811.71
	3-Feb-2023				24.05	3811.85
	2-Nov-2022				23.31	3812.59
	4-Aug-2022				22.52	3813.38
	3-May-2022				23.12	3812.78
	8-Feb-2022				23.06	3812.84
	2-Nov-2021				22.75	3813.15
	5-Aug-2021				22.52	3813.38
	4-May-2021				22.45	3813.45
	11-Feb-2021				21.86	3814.04
	3-Nov-2020				21.38	3814.52
	11-Aug-2020				21.32	3814.58
	12-May-2020				22.07	3813.83
	5-Feb-2020				21.54	3814.36
	8-Nov-2019				20.17	3815.73
	1-Aug-2019				21.65	3814.25
	8-May-2019				21.95	3813.95
	19-Feb-2019				21.35	3814.55
	12-Nov-2018				21.45	3814.45
	6-Aug-2018				20.21	3815.69
	17-May-2018				22.15	3813.75
	6-Feb-2018				21.38	3814.52
	6-Nov-2017				21.15	3814.75
	8-Aug-2017				21.55	3814.35
	15-May-2017				22.79	3813.11
	7-Feb-2017				22.75	3813.15
	8-Nov-2016				22.20	3813.70
	16-Aug-2016				22.20	3813.70
	17-May-2016				23.54	3812.36
	10-Feb-2016				23.14	3812.76
	6-Nov-2015				22.92	3812.98
	6-Aug-2015				22.38	3813.52
	7-May-2015				22.64	3813.26
	6-Feb-2015				22.50	3813.40
	10-Nov-2014				21.80	3814.10
	13-Aug-2014				20.77	3815.13
	12-May-2014				21.34	3814.56
	12-Feb-2014				21.64	3814.26
	7-Nov-2013				20.76	3815.14
	7-Aug-2013				20.17	3815.73
	8-May-2013				20.70	3815.20
	8-Feb-2013				19.25	3816.65
	29-Oct-2012				19.07	3816.83
	30-Jul-2012				18.57	3817.33
	24-Apr-2012				19.12	3816.78
	25-Jan-2012				18.40	3817.50
	13-Dec-2011				18.75	3817.15
19-Jul-2011	17.54	3818.36				
19-Apr-2011	17.31	3818.59				
17-Jan-2011	16.99	3818.91				
15-Sep-2010	16.24	3819.66				
23-Jun-2010	16.53	3819.37				
22-Mar-2010	17.29	3818.61				
8-Dec-2009	16.82	3819.08				
28-Aug-2009	16.63	3819.27				
26-May-2009	16.92	3818.98				
10-Dec-2008	17.05	3818.85				
27-Sep-2008	16.65	3819.25				
10-Jun-2008	17.53	3818.37				
6-Feb-2008	17.33	3818.57				
13-Nov-2007	17.19	3818.71				
13-Sep-2007	16.61	3819.29				

**TABLE 1. SUMMARY OF MONITORING WELL FLUID GAUGING DATA
DONA ANA DAIRIES, DONA ANA COUNTY, NEW MEXICO**

Monitoring Well	Date Measured	Northing ^a	Easting ^a	Casing Elevation ^b	Depth to Water ^c	Ground Water Elevation ^b
DAD-12 Vertical Delineation	2-May-2023	419731.54	1512274.77	3866.72	53.05	3813.67
	2-Feb-2023				52.30	3814.42
	1-Nov-2022				52.86	3813.86
	2-Aug-2022				52.37	3814.35
	2-May-2022				52.90	3813.82
	7-Feb-2022				52.66	3814.06
	1-Nov-2021				52.15	3814.57
	4-Aug-2021				51.51	3815.21
	3-May-2021				51.70	3815.02
	10-Feb-2021				51.30	3815.42
	2-Nov-2020				51.88	3814.84
	10-Aug-2020				52.01	3814.71
	12-May-2020				52.32	3814.40
	4-Feb-2020				51.66	3815.06
	8-Nov-2019				50.91	3815.81
	5-Aug-2019				51.71	3815.01
	8-May-2019				51.75	3814.97
	19-Feb-2019				51.65	3815.07
	13-Nov-2018				51.28	3815.44
	6-Aug-2018				50.60	3816.12
	17-May-2018				52.21	3814.51
	6-Feb-2018				51.35	3815.37
	7-Nov-2017				51.30	3815.42
	8-Aug-2017				52.10	3814.62
	15-May-2017				52.48	3814.24
	7-Feb-2017				52.63	3814.09
	7-Nov-2016				52.41	3814.31
	16-Aug-2016				52.73	3813.99
	17-May-2016				53.20	3813.52
	10-Feb-2016				52.77	3813.95
	6-Nov-2015				52.77	3813.95
	6-Aug-2015				52.87	3813.85
	7-May-2015				52.75	3813.97
	6-Feb-2015				52.18	3814.54
	10-Nov-2014				51.93	3814.79
	13-Aug-2014				51.10	3815.62
	12-May-2014				51.43	3815.29
	12-Feb-2014				50.92	3815.80
	7-Nov-2013				50.49	3816.23
	7-Aug-2013				49.24	3817.48
7-May-2013	49.66	3817.06				
8-Feb-2013	49.36	3817.36				
29-Oct-2012	48.96	3817.76				
31-Jul-2012	48.59	3818.13				
23-Apr-2011	48.44	3818.28				
25-Jan-2012	48.01	3818.71				
6-Dec-2011	48.15	3818.57				

**TABLE 1. SUMMARY OF MONITORING WELL FLUID GAUGING DATA
DONA ANA DAIRIES, DONA ANA COUNTY, NEW MEXICO**

Monitoring Well	Date Measured	Northing ^a	Easting ^a	Casing Elevation ^b	Depth to Water ^c	Ground Water Elevation ^b
DAD-13	2-May-2023	417879.08	1515673.13	3898.44	88.53	3809.91
	2-Feb-2023				87.60	3810.84
	4-Nov-2022				87.33	3811.11
	4-Aug-2022				88.10	3810.34
	3-May-2022				87.50	3810.94
	8-Feb-2022				86.91	3811.53
	2-Nov-2021				87.62	3810.82
	5-Aug-2021				88.50	3809.94
	4-May-2021				87.17	3811.27
	11-Feb-2021				86.29	3812.15
	3-Nov-2020				86.76	3811.68
	11-Aug-2020				87.56	3810.88
	12-May-2020				87.41	3811.03
	5-Feb-2020				86.10	3812.34
	8-Nov-2019				87.13	3811.31
	1-Aug-2019				88.64	3809.80
	8-May-2019				88.75	3809.69
	19-Feb-2019				86.29	3812.15
	12-Nov-2018				86.20	3812.24
	6-Aug-2018				89.48	3808.96
	17-May-2018				89.84	3808.60
	5-Feb-2018				85.81	3812.63
	6-Nov-2017				86.65	3811.79
	8-Aug-2017				88.68	3809.76
	15-May-2017				88.16	3810.28
	7-Feb-2017				86.25	3812.19
	8-Nov-2016				87.04	3811.40
	16-Aug-2016				87.70	3810.74
	20-May-2016				88.63	3809.81
	10-Feb-2016				86.30	3812.14
	6-Nov-2015				86.40	3812.04
	6-Aug-2015				88.65	3809.79
	7-May-2015				88.05	3810.39
	6-Feb-2015				85.50	3812.94
	10-Nov-2014				85.74	3812.70
	13-Aug-2014				86.67	3811.77
13-May-2014	87.24	3811.20				
12-Feb-2014	84.45	3813.99				
7-Nov-2013	85.43	3813.01				
14-Aug-2013	86.46	3811.98				
8-May-2013	84.96	3813.48				
8-Feb-2013	84.81	3813.63				
29-Oct-2012	85.39	3813.05				
30-Jul-2012	85.51	3812.93				
23-Apr-2012	83.56	3814.88				
25-Jan-2012	82.72	3815.72				
8-Dec-2011	82.88	3815.56				

**TABLE 1. SUMMARY OF MONITORING WELL FLUID GAUGING DATA
DONA ANA DAIRIES, DONA ANA COUNTY, NEW MEXICO**

Monitoring Well	Date Measured	Northing ^a	Easting ^a	Casing Elevation ^b	Depth to Water ^c	Ground Water Elevation ^b
DAD-14	2-May-2023	414923.33	1514695.26	3841.90	31.85	3810.05
	3-Feb-2023				31.52	3810.38
	2-Nov-2022				31.30	3810.60
	4-Aug-2022				30.65	3811.25
	3-May-2022				30.80	3811.10
	8-Feb-2022				30.44	3811.46
	2-Nov-2021				30.51	3811.39
	5-Aug-2021				30.22	3811.68
	4-May-2021				30.25	3811.65
	11-Feb-2021				29.31	3812.59
	3-Nov-2020				29.43	3812.47
	11-Aug-2020				29.36	3812.54
	11-May-2010				29.85	3812.05
	5-Feb-2020				29.30	3812.60
	8-Nov-2019				29.64	3812.26
	1-Aug-2019				30.10	3811.80
	8-May-2019				29.77	3812.13
	19-Feb-2019				29.24	3812.66
	12-Nov-2018				29.30	3812.60
	6-Aug-2018				29.35	3812.55
	17-May-2018				29.55	3812.35
	5-Feb-2018				28.80	3813.10
	6-Nov-2017				29.07	3812.83
	9-Aug-2017				29.75	3812.15
	15-May-2017				30.40	3811.50
	7-Feb-2017				30.00	3811.90
	8-Nov-2016				30.18	3811.72
	16-Aug-2016				30.55	3811.35
	17-May-2016				30.95	3810.95
	10-Feb-2016				30.47	3811.43
	6-Nov-2015				30.54	3811.36
	6-Aug-2015				30.47	3811.43
	7-May-2015				30.29	3811.61
	6-Feb-2015				29.83	3812.07
	10-Nov-2014				29.50	3812.40
	13-Aug-2014				28.63	3813.27
	13-May-2014				29.68	3812.22
	12-Feb-2014				29.02	3812.88
	7-Nov-2013				28.44	3813.46
	7-Aug-2013				28.25	3813.65
8-May-2013	28.15	3813.75				
8-Feb-2013	27.31	3814.59				
25-Oct-2012	26.62	3815.28				
30-Jul-2012	25.85	3816.05				
24-Apr-2012	26.07	3815.83				
25-Jan-2012	26.10	3815.80				
8-Dec-2011	26.30	3815.60				

**TABLE 1. SUMMARY OF MONITORING WELL FLUID GAUGING DATA
DONA ANA DAIRIES, DONA ANA COUNTY, NEW MEXICO**

Monitoring Well	Date Measured	Northing ^a	Easting ^a	Casing Elevation ^b	Depth to Water ^c	Ground Water Elevation ^b
DAD-15	3-May-2023	402001.22	1523552.04	3897.61	97.01	3800.60
	6-Feb-2023				96.80	3800.81
	3-Nov-2022				96.77	3800.84
	4-Aug-2022				96.70	3800.91
	3-May-2022				96.38	3801.23
	10-Feb-2022				96.11	3801.50
	2-Nov-2021				96.30	3801.31
	5-Aug-2021				Not Gauged - Inaccessible	
	5-May-2021				96.24	3801.37
	11-Feb-2021				95.91	3801.70
	4-Nov-2020				96.25	3801.36
	12-Aug-2020				95.73	3801.88
	12-May-2020				96.39	3801.22
	6-Feb-2020				95.22	3802.39
	25-Nov-2019				96.40	3801.21
	5-Aug-2019				96.30	3801.31
	9-May-2019				96.00	3801.61
	21-Feb-2019				95.71	3801.90
	13-Nov-2018				96.05	3801.56
	7-Aug-2018				95.74	3801.87
	17-May-2018				95.65	3801.96
	6-Feb-2018				95.62	3801.99
	7-Nov-2017				95.86	3801.75
	15-Aug-2017				96.41	3801.20
	16-May-2017				96.18	3801.43
	16-Feb-2017				95.81	3801.80
	8-Nov-2016				96.21	3801.40
	16-Aug-2016				96.38	3801.23
	17-May-2016				96.32	3801.29
	10-Feb-2016				96.00	3801.61
	6-Nov-2015				96.08	3801.53
	6-Aug-2015				96.05	3801.56
	7-May-2015				96.05	3801.56
	6-Feb-2015				95.65	3801.96
	6-Nov-2014				95.11	3802.50
14-Aug-2014	95.50	3802.11				
13-May-2014	95.47	3802.14				
12-Feb-2014	94.81	3802.80				
7-Nov-2013	95.08	3802.53				
7-Aug-2013	95.31	3802.30				
8-May-2013	94.35	3803.26				
8-Feb-2013	94.01	3803.60				
29-Oct-2012	93.78	3803.83				

**TABLE 1. SUMMARY OF MONITORING WELL FLUID GAUGING DATA
DONA ANA DAIRIES, DONA ANA COUNTY, NEW MEXICO**

Monitoring Well	Date Measured	Northing ^a	Easting ^a	Casing Elevation ^b	Depth to Water ^c	Ground Water Elevation ^b
DAD-16	3-May-2023	400628.77	1519350.74	3819.28	20.05	3799.23
	6-Feb-2023				19.85	3799.43
	3-Nov-2022				20.30	3798.98
	4-Aug-2022				20.02	3799.26
	4-May-2022				19.39	3799.89
	8-Feb-2022				18.65	3800.63
	3-Nov-2021				19.13	3800.15
	6-Aug-2021				20.01	3799.27
	5-May-2021				16.57	3802.71
	11-Feb-2021				17.32	3801.96
	3-Nov-2020				17.76	3801.52
	11-Aug-2020				18.04	3801.24
	12-May-2020				18.40	3800.88
	6-Feb-2020				17.25	3802.03
	8-Nov-2019				18.44	3800.84
	5-Aug-2019				19.03	3800.25
	9-May-2019				19.25	3800.03
	20-Feb-2019				17.45	3801.83
	13-Nov-2018				17.90	3801.38
	7-Aug-2018				18.00	3801.28
	17-May-2018				18.45	3800.83
	6-Feb-2018				16.39	3802.89
	7-Nov-2017				16.26	3803.02
	9-Aug-2017				16.60	3802.68
	16-May-2017				19.34	3799.94
	7-Feb-2017				17.16	3802.12
	8-Nov-2016				17.73	3801.55
	16-Aug-2016				17.70	3801.58
	17-May-2016				20.22	3799.06
	10-Feb-2016				18.46	3800.82
	6-Nov-2015				19.24	3800.04
	6-Aug-2015				19.46	3799.82
	7-May-2015				20.45	3798.83
	6-Feb-2015				18.45	3800.83
	10-Nov-2014				18.94	3800.34
	13-Aug-2014				19.45	3799.83
	13-May-2014				20.31	3798.97
	13-Feb-2014				18.45	3800.83
	7-Nov-2013				18.94	3800.34
	7-Aug-2013				19.06	3800.22
8-May-2013	18.49	3800.79				
8-Feb-2013	17.20	3802.08				
29-Oct-2012	17.23	3802.05				
31-Jul-2012	18.58	3800.70				
24-Apr-2012	17.64	3801.64				
25-Jan-2012	16.50	3802.78				
8-Dec-2011	16.58	3802.70				

**TABLE 1. SUMMARY OF MONITORING WELL FLUID GAUGING DATA
DONA ANA DAIRIES, DONA ANA COUNTY, NEW MEXICO**

Monitoring Well	Date Measured	Northing ^a	Easting ^a	Casing Elevation ^b	Depth to Water ^c	Ground Water Elevation ^b
DAD-17	4-May-2023	393991.97	1520267.94	3817.75	21.66	3796.09
	7-Feb-2023				20.79	3796.96
	4-Nov-2022				21.27	3796.48
	5-Aug-2022				21.69	3796.06
	4-May-2022				20.87	3796.88
	9-Feb-2022				20.02	3797.73
	3-Nov-2021				20.26	3797.49
	6-Aug-2021				20.99	3796.76
	5-May-2021				19.91	3797.84
	12-Feb-2021				19.05	3798.70
	4-Nov-2020				19.00	3798.75
	12-Aug-2020				19.03	3798.72
	12-May-2020				19.97	3797.78
	6-Feb-2020				18.87	3798.88
	8-Nov-2019				18.18	3799.57
	2-Aug-2019				19.31	3798.44
	9-May-2019				20.17	3797.58
	19-Feb-2019				19.20	3798.55
	13-Nov-2018				19.35	3798.40
	7-Aug-2018				18.72	3799.03
	14-May-2018				21.04	3796.71
	6-Feb-2018				18.61	3799.14
	7-Nov-2017				18.41	3799.34
	9-Aug-2017				18.07	3799.68
	16-May-2017				20.56	3797.19
	7-Feb-2017				19.47	3798.28
	8-Nov-2016				20.18	3797.57
	16-Aug-2016				20.17	3797.58
	17-May-2016				22.97	3794.78
	10-Feb-2016				21.22	3796.53
	6-Nov-2015				22.95	3794.80
	13-Aug-2015				21.95	3795.80
	7-May-2015				22.59	3795.16
	6-Feb-2015				21.00	3796.75
	10-Nov-2014				21.76	3795.99
	13-Aug-2014				20.32	3797.43
	13-May-2014				23.32	3794.43
	12-Feb-2014				20.05	3797.70
	7-Nov-2013				20.21	3797.54
	7-Aug-2013				19.75	3798.00
13-May-2013	19.37	3798.38				
8-Feb-2013	18.55	3799.20				
29-Oct-2012	19.18	3798.57				
2-Aug-2012	19.07	3798.68				
24-Apr-2012	21.01	3796.74				
25-Jan-2012	17.74	3800.01				
9-Dec-2011	19.21	3798.54				

**TABLE 1. SUMMARY OF MONITORING WELL FLUID GAUGING DATA
DONA ANA DAIRIES, DONA ANA COUNTY, NEW MEXICO**

Monitoring Well	Date Measured	Northing ^a	Easting ^a	Casing Elevation ^b	Depth to Water ^c	Ground Water Elevation ^b
DAD-18 Vertical Delineation	4-May-2023	395714.14	1520588.96	3821.59	24.55	3797.04
	7-Feb-2023				23.91	3797.68
	4-Nov-2022				24.48	3797.11
	5-Aug-2022				23.86	3797.73
	4-May-2022				24.18	3797.41
	9-Feb-2022				23.41	3798.18
	3-Nov-2021				24.06	3797.53
	6-Aug-2021				23.70	3797.89
	5-May-2021				23.11	3798.48
	12-Feb-2021				22.02	3799.57
	4-Nov-2020				21.24	3800.35
	12-Aug-2020				20.65	3800.94
	12-May-2020				21.28	3800.31
	6-Feb-2020				20.19	3801.40
	8-Nov-2019				20.00	3801.59
	2-Aug-2019				21.26	3800.33
	9-May-2019				23.49	3798.10
	20-Feb-2019				22.24	3799.35
	13-Nov-2018				22.43	3799.16
	7-Aug-2018				21.95	3799.64
	14-May-2018				23.58	3798.01
	6-Feb-2018				22.00	3799.59
	7-Nov-2017				22.41	3799.18
	7-Aug-2017				21.97	3799.62
	16-May-2017				24.19	3797.40
	7-Feb-2017				23.25	3798.34
	8-Nov-2016				23.55	3798.04
	16-Aug-2016				22.10	3799.49
	17-May-2016				25.39	3796.20
	10-Feb-2016				23.81	3797.78
	6-Nov-2015				24.35	3797.24
	13-Aug-2015				23.37	3798.22
	7-May-2015				25.84	3795.75
	6-Feb-2015				23.73	3797.86
10-Nov-2014	24.90	3796.69				
12-Aug-2014	22.93	3798.66				
13-May-2014	25.33	3796.26				
17-Feb-2014	23.03	3798.56				
7-Nov-2013	23.25	3798.34				
7-Aug-2013	24.23	3797.36				
13-May-2013	22.97	3798.62				
8-Feb-2013	22.04	3799.55				
29-Oct-2012	22.40	3799.19				
1-Aug-2012	22.43	3799.16				
24-Apr-2012	22.20	3799.39				
25-Jan-2012	21.33	3800.26				
6-Dec-2011	21.43	3800.16				

**TABLE 1. SUMMARY OF MONITORING WELL FLUID GAUGING DATA
DONA ANA DAIRIES, DONA ANA COUNTY, NEW MEXICO**

Monitoring Well	Date Measured	Northing ^a	Easting ^a	Casing Elevation ^b	Depth to Water ^c	Ground Water Elevation ^b
DAD-19 Vertical Delineation	4-May-2023	400164.47	1522027.92	3864.50	66.28	3798.22
	7-Feb-2023				65.40	3799.10
	4-Nov-2022				65.64	3798.86
	5-Aug-2022				65.41	3799.09
	4-May-2022				64.58	3799.92
	9-Feb-2022				63.66	3800.84
	3-Nov-2021				64.50	3800.00
	6-Aug-2021				64.90	3799.60
	5-May-2021				64.38	3800.12
	12-Feb-2021				63.43	3801.07
	4-Nov-2020				63.62	3800.88
	11-Aug-2020				63.89	3800.61
	12-May-2020				64.57	3799.93
	6-Feb-2020				63.98	3800.52
	7-Nov-2019				64.59	3799.91
	2-Aug-2019				64.79	3799.71
	9-May-2019				64.35	3800.15
	20-Feb-2019				63.40	3801.10
	13-Nov-2018				64.06	3800.44
	7-Aug-2018				63.95	3800.55
	14-May-2018				63.38	3801.12
	6-Feb-2018				62.67	3801.83
	7-Nov-2017				62.88	3801.62
	9-Aug-2017				63.71	3800.79
	16-May-2017				64.53	3799.97
	7-Feb-2017				63.57	3800.93
	8-Nov-2016				64.00	3800.50
	16-Aug-2016				64.54	3799.96
	17-May-2016				64.73	3799.77
	10-Feb-2016				64.50	3800.00
	6-Nov-2015				64.78	3799.72
	6-Aug-2015				65.35	3799.15
	7-May-2015				65.56	3798.94
	6-Feb-2015				64.38	3800.12
	10-Nov-2014				64.50	3800.00
	12-Aug-2014				65.29	3799.21
	13-May-2014				65.26	3799.24
	12-Feb-2014				63.99	3800.51
	7-Nov-2013				64.11	3800.39
	7-Aug-2013				64.46	3800.04
14-May-2013	63.75	3800.75				
8-Feb-2013	62.95	3801.55				
29-Oct-2012	62.30	3802.20				
1-Aug-2012	63.70	3800.80				
24-Apr-2012	63.31	3801.19				
25-Jan-2012	62.25	3802.25				
6-Dec-2011	62.29	3802.21				

**TABLE 1. SUMMARY OF MONITORING WELL FLUID GAUGING DATA
DONA ANA DAIRIES, DONA ANA COUNTY, NEW MEXICO**

Monitoring Well	Date Measured	Northing ^a	Easting ^a	Casing Elevation ^b	Depth to Water ^c	Ground Water Elevation ^b
DAD-20	4-May-2023	371751.45	1531188.19	3833.27	57.59	3775.68
	7-Feb-2023				57.06	3776.21
	4-Nov-2022				57.39	3775.88
	5-Aug-2022				57.22	3776.05
	4-May-2022				56.81	3776.46
	10-Feb-2022				56.20	3777.07
	3-Nov-2021				56.68	3776.59
	6-Aug-2021				56.51	3776.76
	5-May-2021				56.08	3777.19
	12-Feb-2021				55.47	3777.80
	4-Nov-2020				55.60	3777.67
	12-Aug-2020				55.26	3778.01
	12-May-2020				54.88	3778.39
	6-Feb-2020				53.54	3779.73
	7-Nov-2019				53.55	3779.72
	5-Aug-2019				54.55	3778.72
	9-May-2019				54.98	3778.29
	20-Feb-2019				54.60	3778.67
	13-Nov-2018				54.60	3778.67
	7-Aug-2018				54.80	3778.47
	14-May-2018				54.96	3778.31
	6-Feb-2018				54.27	3779.00
	6-Nov-2017				54.41	3778.86
	9-Aug-2017				54.71	3778.56
	16-May-2017				55.10	3778.17
	16-Feb-2017				54.55	3778.72
	8-Nov-2016				54.84	3778.43
	16-Aug-2016				54.97	3778.30
	17-May-2016				54.94	3778.33
	10-Feb-2016				54.50	3778.77
	6-Nov-2015				54.41	3778.86
	6-Aug-2015				54.32	3778.95
	7-May-2015				54.40	3778.87
	6-Feb-2015				54.26	3779.01
	6-Nov-2014				54.44	3778.83
	12-Aug-2014				54.26	3779.01
	13-May-2014				54.20	3779.07
	13-Feb-2014				53.54	3779.73
	7-Nov-2013				53.70	3779.57
	7-Aug-2013				53.43	3779.84
8-May-2013	52.88	3780.39				
8-Feb-2013	52.29	3780.98				
7-Nov-2012	52.18	3781.09				
29-Oct-2012	Obstruction in Well					
2-Aug-2012	Obstruction in Well					
25-Apr-2012	Obstruction in Well					
25-Jan-2012	50.65	3782.62				
6-Dec-2011	50.66	3782.61				

**TABLE 1. SUMMARY OF MONITORING WELL FLUID GAUGING DATA
DONA ANA DAIRIES, DONA ANA COUNTY, NEW MEXICO**

Monitoring Well	Date Measured	Northing ^a	Easting ^a	Casing Elevation ^b	Depth to Water ^c	Ground Water Elevation ^b
DAD-21	4-May-2023	374013.39	1530983.98	3839.62	58.40	3781.22
	7-Feb-2023				58.02	3781.60
	4-Nov-2022				57.21	3782.41
	5-Aug-2022				56.51	3783.11
	4-May-2022				55.70	3783.92
	10-Feb-2022				54.81	3784.81
	3-Nov-2021				55.25	3784.37
	6-Aug-2021				56.12	3783.50
	5-May-2021				55.97	3783.65
	12-Feb-2021				55.90	3783.72
	4-Nov-2020				56.12	3783.50
	12-Aug-2020				56.25	3783.37
	12-May-2020				56.33	3783.29
	6-Feb-2020				57.02	3782.60
	8-Nov-2019				56.12	3783.50
	2-Aug-2019				57.76	3781.86
	9-May-2019				57.58	3782.04
	20-Feb-2019				58.62	3781.00
	13-Nov-2018				58.85	3780.77
	7-Aug-2018				58.79	3780.83
	17-May-2018				58.82	3780.80
	6-Feb-2018				58.65	3780.97
	6-Nov-2017				58.61	3781.01
	9-Aug-2017				59.28	3780.34
	16-May-2017				59.13	3780.49
	7-Feb-2017				59.02	3780.60
	8-Nov-2016				58.95	3780.67
	16-Aug-2016				58.79	3780.83
	17-May-2016				58.54	3781.08
	10-Feb-2016				58.48	3781.14
	6-Nov-2015				58.13	3781.49
	6-Aug-2015				57.83	3781.79
	7-May-2015				57.56	3782.06
	6-Feb-2015				57.16	3782.46
	6-Nov-2014				56.97	3782.65
	12-Aug-2014				56.82	3782.80
13-May-2014	56.42	3783.20				
17-Feb-2014	55.97	3783.65				
7-Nov-2013	55.89	3783.73				
7-Aug-2013	55.81	3783.81				
7-May-2013	55.43	3784.19				
8-Feb-2013	55.10	3784.52				
29-Oct-2012	54.60	3785.02				
2-Aug-2012	54.31	3785.31				
24-Apr-2012	53.61	3786.01				
30-Jan-2012	53.44	3786.18				
6-Dec-2011	53.24	3786.38				

**TABLE 1. SUMMARY OF MONITORING WELL FLUID GAUGING DATA
DONA ANA DAIRIES, DONA ANA COUNTY, NEW MEXICO**

Monitoring Well	Date Measured	Northing ^a	Easting ^a	Casing Elevation ^b	Depth to Water ^c	Ground Water Elevation ^b
DAD-22	4-May-2023	373029.62	1530352.69	3827.14	47.00	3780.14
	7-Feb-2023				47.05	3780.09
	4-Nov-2022				47.31	3779.83
	5-Aug-2022				47.15	3779.99
	4-May-2022				46.70	3780.44
	10-Feb-2022				46.22	3780.92
	3-Nov-2021				46.53	3780.61
	6-Aug-2021				46.76	3780.38
	5-May-2021				46.46	3780.68
	12-Feb-2021				46.79	3780.35
	4-Nov-2020				47.33	3779.81
	12-Aug-2020				46.72	3780.42
	12-May-2020				46.62	3780.52
	6-Feb-2020				46.29	3780.85
	8-Nov-2019				46.03	3781.11
	2-Aug-2019				47.00	3780.14
	9-May-2019				47.33	3779.81
	20-Feb-2019				47.31	3779.83
	13-Nov-2018				47.30	3779.84
	7-Aug-2018				47.81	3779.33
	17-May-2018				47.77	3779.37
	6-Feb-2018				47.80	3779.34
	7-Nov-2017				48.11	3779.03
	9-Aug-2017				48.62	3778.52
	16-May-2017				48.57	3778.57
	7-Feb-2017				48.20	3778.94
	8-Nov-2016				48.30	3778.84
	16-Aug-2016				48.17	3778.97
	17-May-2016				47.91	3779.23
	10-Feb-2016				47.57	3779.57
	6-Nov-2015				47.64	3779.50
	6-Aug-2015				47.65	3779.49
	7-May-2015				47.54	3779.60
	6-Feb-2015				47.30	3779.84
	6-Nov-2014				47.14	3780.00
	12-Aug-2014				46.98	3780.16
13-May-2014	46.56	3780.58				
17-Feb-2014	46.18	3780.96				
7-Nov-2013	45.73	3781.41				
7-Aug-2013	45.77	3781.37				
14-May-2013	44.09	3783.05				
8-Feb-2013	44.08	3783.06				
29-Oct-2012	44.51	3782.63				
2-Aug-2012	44.23	3782.91				
25-Apr-2012	43.86	3783.28				
25-Jan-2012	43.22	3783.92				
13-Dec-2011	43.27	3783.87				

**TABLE 1. SUMMARY OF MONITORING WELL FLUID GAUGING DATA
DONA ANA DAIRIES, DONA ANA COUNTY, NEW MEXICO**

Monitoring Well	Date Measured	Northing ^a	Easting ^a	Casing Elevation ^b	Depth to Water ^c	Ground Water Elevation ^b
DAD-23	3-May-2023	413958.29	1515697.17	3855.46	46.46	3809.00
	3-Feb-2023				45.88	3809.58
	3-Nov-2022				46.00	3809.46
	4-Aug-2022				45.62	3809.84
	3-May-2022				45.30	3810.16
	8-Feb-2022				44.80	3810.66
	2-Nov-2021				45.08	3810.38
	5-Aug-2021				44.81	3810.65
	4-May-2021				44.70	3810.76
	11-Feb-2021				43.75	3811.71
	3-Nov-2020				44.15	3811.31
	11-Aug-2020				44.61	3810.85
	12-May-2020				44.45	3811.01
	5-Feb-2020				43.86	3811.60
	8-Nov-2019				43.33	3812.13
	1-Aug-2019				44.85	3810.61
	8-May-2019				44.23	3811.23
	19-Feb-2019				43.75	3811.71
	12-Nov-2018				43.94	3811.52
	6-Aug-2018				44.18	3811.28
	17-May-2018				44.00	3811.46
	6-Feb-2018				43.24	3812.22
	6-Nov-2017				43.72	3811.74
	9-Aug-2017				44.55	3810.91
	16-May-2017				44.84	3810.62
	7-Feb-2017				44.32	3811.14
	8-Nov-2016				44.85	3810.61
	17-Aug-2016				45.38	3810.08
17-May-2016	45.52	3809.94				
11-Feb-2016	45.37	3810.09				

**TABLE 1. SUMMARY OF MONITORING WELL FLUID GAUGING DATA
DONA ANA DAIRIES, DONA ANA COUNTY, NEW MEXICO**

Monitoring Well	Date Measured	Northing ^a	Easting ^a	Casing Elevation ^b	Depth to Water ^c	Ground Water Elevation ^b
DAD-24 Vertical Delineation	4-May-2023	400183.23	1522052.57	3864.91	67.71	3797.20
	7-Feb-2023				66.80	3798.11
	4-Nov-2022				67.50	3797.41
	5-Aug-2022				68.68	3796.23
	4-May-2022				67.77	3797.14
	9-Feb-2022				66.86	3798.05
	3-Nov-2021				67.68	3797.23
	6-Aug-2021				68.00	3796.91
	5-May-2021				67.20	3797.71
	12-Feb-2021				66.60	3798.31
	4-Nov-2020				66.92	3797.99
	11-Aug-2020				67.28	3797.63
	12-May-2020				67.66	3797.25
	6-Feb-2020				67.10	3797.81
	7-Nov-2019				68.27	3796.64
	2-Aug-2019				67.44	3797.47
	9-May-2019				67.45	3797.46
	20-Feb-2019				64.52	3800.39
	13-Nov-2018				64.92	3799.99
	7-Aug-2018				66.86	3798.05
	14-May-2018				66.88	3798.03
	6-Feb-2018				64.40	3800.51
	7-Nov-2017				64.70	3800.21
	9-Aug-2017				64.75	3800.16
16-May-2017	66.80	3798.11				
7-Feb-2017	66.04	3798.87				
8-Nov-2016	65.95	3798.96				
16-Aug-2016	65.60	3799.31				
17-May-2016	67.91	3797.00				
11-Feb-2016	67.85	3797.06				
DAD-25	4-May-2023	394560.83	1524599.12	3870.63	67.52	3803.11
	7-Feb-2023				67.32	3803.31
	4-Nov-2022				67.09	3803.54
	5-Aug-2022				66.97	3803.66
	4-May-2022				66.73	3803.90
	9-Feb-2022				67.55	3803.08
	3-Nov-2021				68.01	3802.62
	6-Aug-2021				68.70	3801.93
	5-May-2021				69.09	3801.54
	12-Feb-2021				68.38	3802.25
	4-Nov-2020				68.29	3802.34
	12-Aug-2020				67.66	3802.97
	12-May-2020				68.17	3802.46
	6-Feb-2020				67.03	3803.60
	8-Nov-2019				66.11	3804.52
	2-Aug-2019				67.81	3802.82
	9-May-2019				67.73	3802.90
	20-Feb-2019				67.65	3802.98
	13-Nov-2018				67.49	3803.14
	7-Aug-2018				67.20	3803.43
	14-May-2018				66.90	3803.73
	6-Feb-2018				66.49	3804.14
	7-Nov-2017				64.82	3805.81
	9-Aug-2017				65.00	3805.63
16-May-2017	66.21	3804.42				
7-Feb-2017	65.72	3804.91				
8-Nov-2016	65.31	3805.32				
16-Aug-2016	64.84	3805.79				
17-May-2016	64.55	3806.08				
11-Feb-2016	64.11	3806.52				

**TABLE 1. SUMMARY OF MONITORING WELL FLUID GAUGING DATA
DONA ANA DAIRIES, DONA ANA COUNTY, NEW MEXICO**

Monitoring Well	Date Measured	Northing ^a	Easting ^a	Casing Elevation ^b	Depth to Water ^c	Ground Water Elevation ^b
DAD-26	4-May-2023	372513.58	1530789.76	3829.31	49.84	3779.47
	7-Feb-2023				49.73	3779.58
	4-Nov-2022				50.29	3779.02
	5-Aug-2022				50.20	3779.11
	4-May-2022				49.79	3779.52
	10-Feb-2022				49.30	3780.01
	3-Nov-2021				49.75	3779.56
	6-Aug-2021				49.51	3779.80
	5-May-2021				49.35	3779.96
	12-Feb-2021				49.25	3780.06
	4-Nov-2020				49.50	3779.81
	12-Aug-2020				49.40	3779.91
	12-May-2020				49.00	3780.31
	6-Feb-2020				48.00	3781.31
	8-Nov-2019				47.83	3781.48
	2-Aug-2019				48.45	3780.86
	9-May-2019				49.18	3780.13
	20-Feb-2019				50.12	3779.19
	13-Nov-2018				50.66	3778.65
	7-Aug-2018				50.75	3778.56
	17-May-2018				50.69	3778.62
	6-Feb-2018				50.35	3778.96
	6-Nov-2017				50.66	3778.65
	9-Aug-2017				51.10	3778.21
16-May-2017	51.11	3778.20				
7-Feb-2017	50.70	3778.61				
8-Nov-2016	51.07	3778.24				
17-Aug-2016	50.97	3778.34				
17-May-2016	50.55	3778.76				
11-Feb-2016	50.30	3779.01				
DAD-27	4-May-2023	371781.16	1528921.96	3804.23	27.70	3776.53
	8-Feb-2023				27.10	3777.13

Notes:

^a Horizontal control to NM State Plane Coordinates Central NAD83 Grid Coordinates (in feet)

^b Vertical Control to NAVD88 Datum in feet above mean sea level

^c Measured in feet below the top of casing at survey point on north side of well

^d Measured in feet

Gauging data from current quarter.

Wells were gauged on a different date by Magee and Associates Inc.

Wells were gauged on a different date by EnviroCompliance Inc.

Groundwater elevation is anomalous.

Measured data were suspect and corrected to reflect appropriate trends in accordance with surrounding wells.

**TABLE 2. SUMMARY OF MONITORING WELL GROUNDWATER FIELD PARAMETERS
DONA ANA DAIRIES, DONA ANA COUNTY, NEW MEXICO**

Monitoring Well	Date Measured	pH	SpC (uS/cm)	Temp (°C)	DO (mg/L)	ORP (mV)
NORTHERN AREA						
Northern Land Application Area						
70-03	8-May-2023	7.20	7,133	20.7	1.08	156
	9-Feb-2023	7.23	6,941	20.0	2.88	176
	8-Nov-2022	7.26	7,208	21.7	2.08	163
	9-Aug-2022	7.30	7,265	22.4	2.69	168
	9-May-2022	7.19	6,729	22.1	2.35	149
	15-Feb-2022	7.20	6,560	20.6	2.91	159
	5-Nov-2021	7.24	6,943	21.3	2.70	269
	10-Aug-2021	7.61	7,280	21.9	2.38	54
	10-May-2021	7.18	7,423	21.4	2.09	191
	16-Feb-2021	7.36	7,008	19.5	1.81	126
	11-Nov-2020	7.38	7,493	20.8	2.38	100
	14-Aug-2020	7.43	8,430	22.6	2.20	145
	13-May-2020	7.42	9,512	22.6	2.33	104
	7-Feb-2020	7.66	8,733	20.4	8.37	64
	15-Nov-2019	6.52	9,236	20.7	2.08	131
	6-Aug-2019	6.86	10,460	21.7	NM	162
	16-May-2019	7.25	10,470	21.9	4.22	35
	26-Feb-2019	6.57	6,164	20.7	1.29	176
	15-Nov-2018	6.68	11,020	19.8	1.74	180
	15-Aug-2018	7.08	11,530	22.6	1.34	140
	21-May-2018	6.58	11,570	21.30	NM	110
	13-Feb-2018	7.11	11,890	20.30	2.12	147
	9-Nov-2017	6.71	11,700	18.90	3.07	135
	14-Aug-2017	7.09	12,340	21.70	4.50	37
	19-May-2017	6.91	11,880	20.76	2.61	226.7
	20-Feb-2017	7.54	10,832	20.68	3.78	181.6
	22-Nov-2016	7.12	11,539	20.12	3.93	95.5
	18-Aug-2016	6.92	11,818	21.34	2.26	29.4
24-May-2016	6.95	10,486	20.41	2.90	46.2	
16-Feb-2016	6.50	9,366	19.76	3.00	253.4	
12-Nov-2015	7.16	9,359	20.21	1.32	206.1	
19-Aug-2015	6.96	11,433	25.28	NM	209.7	

**TABLE 2. SUMMARY OF MONITORING WELL GROUNDWATER FIELD PARAMETERS
DONA ANA DAIRIES, DONA ANA COUNTY, NEW MEXICO**

Monitoring Well	Date Measured	pH	SpC (uS/cm)	Temp (°C)	DO (mg/L)	ORP (mV)
70/86/340-01	5-May-2023	7.27	9,163	20.6	2.73	141
	8-Feb-2023	7.20	9,515	19.1	1.15	166
	7-Nov-2022	7.24	9,436	20.50	1.77	129.0
	8-Aug-2022	7.18	8,843	21.8	2.75	174
	5-May-2022	7.19	8,781	20.4	2.90	156
	14-Feb-2022	7.17	7,999	19.0	2.80	152
	4-Nov-2021	7.20	5,509	19.7	2.93	286
	9-Aug-2021	7.75	4,712	21.4	2.91	89
	6-May-2021	7.47	5,732	21.6	2.48	183
	15-Feb-2021	7.63	7,190	18.9	2.90	76
	11-Nov-2020	7.26	6,479	19.6	1.39	134
	13-Aug-2020	7.40	6,967	22.0	2.03	158
	18-May-2020	7.48	6,891	21.9	2.42	153
	7-Feb-2020	7.63	6,896	20.3	13.97	58
	15-Nov-2019	6.54	6,880	20.3	0.78	192
	7-Aug-2019	6.95	7,219	20.9	NM	145
	16-May-2019	7.73	7,135	21.4	2.81	72
	25-Feb-2019	7.17	5,654	20.3	2.07	143
	16-Nov-2018	6.97	6,977	19.7	2.94	165
	14-Aug-2018	7.16	7,121	22.2	3.17	125
	21-May-2018	6.66	7,060	21.40	3.51	109
	12-Feb-2018	7.21	7,190	18.80	4.19	129
	9-Nov-2017	6.93	6,928	18.50	3.12	121
	11-Aug-2017	7.25	7,974	25.00	3.57	143
	18-May-2017	6.94	7,521	20.20	2.12	183.5
	16-Feb-2017	7.27	6,420	20.36	6.36	226.7
	10-Nov-2016	7.17	7,573	20.99	3.88	133.6
	23-Aug-2016	6.90	7,584	20.69	1.24	34.1
	19-May-2016	7.09	6,422	20.36	2.88	78.0
	15-Feb-2016	6.07	6,451	18.64	3.83	223.4
10-Nov-2015	7.21	6,827	18.52	1.91	174.5	
20-Aug-2015	6.90	6,824	21.36	NM	277.1	
86/340-01	5-May-2023	7.28	3,221	20.1	2.46	125
	8-Feb-2023	7.24	3,260	18.9	2.46	162
	7-Nov-2022	7.27	3,174	20.70	2.39	142.0
	8-Aug-2022	7.19	3,135	20.9	2.36	168
	5-May-2022	7.17	3,065	19.7	2.31	139
	14-Feb-2022	7.55	3,157	18.8	2.37	142
	4-Nov-2021	7.24	3,214	19.1	2.55	264
	9-Aug-2021	7.70	3,112	21.9	2.31	170
	6-May-2021	7.21	3,065	21.9	2.29	155
	15-Feb-2021	7.19	2,982	17.4	2.31	95
	11-Nov-2020	7.13	2,958	19.3	2.38	217
	13-Aug-2020	7.60	2,955	21.6	1.95	166
	18-May-2020	7.46	2,987	21.4	2.27	265
	7-Feb-2020	7.75	2,732	18.6	7.27	42
	15-Nov-2019	6.87	2,788	18.9	1.54	318
	7-Aug-2019	7.41	3,016	20.7	NM	197
	16-May-2019	7.68	2,775	20.5	3.09	97
	25-Feb-2019	6.68	2,769	18.8	2.63	153
	16-Nov-2018	7.13	2,828	18.9	2.35	161
	14-Aug-2018	7.01	2,692	22.2	2.74	162
	21-May-2018	7.16	2,782	20.10	2.29	79
	12-Feb-2018	7.54	2,829	19.30	2.54	128
	9-Nov-2017	7.64	2,929	18.20	2.23	86
	11-Aug-2017	7.59	3,064	21.60	4.01	173
	18-May-2017	7.36	3,341	20.17	4.31	235.5
	16-Feb-2017	7.50	3,143	20.23	11.17	344.6
	10-Nov-2016	7.39	3,080	19.78	1.81	158.2
	22-Aug-2016	7.31	3,150	20.35	1.84	29.6
	19-May-2016	7.41	2,925	20.15	1.97	71.4
	15-Feb-2016	5.16	2,992	19.24	1.84	237.2
10-Nov-2015	7.55	2,951	17.52	1.74	153.4	
20-Aug-2015	7.29	2,970	20.60	NM	267.0	

**TABLE 2. SUMMARY OF MONITORING WELL GROUNDWATER FIELD PARAMETERS
DONA ANA DAIRIES, DONA ANA COUNTY, NEW MEXICO**

Monitoring Well	Date Measured	pH	SpC (uS/cm)	Temp (°C)	DO (mg/L)	ORP (mV)
Organ Dairy (Formerly known as Del Norte Dairy and Daybreak Dairy)						
126-04	24-May-2023	Insufficient Water-Parameters Not Collected				
	17-Aug-2022					
	5-May-2022	7.16	5,230	22.6	3.4	190
	24-Feb-2022	7.35	4,680	18.9	2.7	207
	9-Nov-2021	7.32	4,700	18.9	2.6	185
	11-Aug-2021	7.22	2,930	23.9	3.5	252
	4-May-2021	7.25	4,240	20.1	3.4	304
	9-Feb-2021	7.30	4,180	20.4	3.7	222
	10-Nov-2020	7.13	4,580	20.3	NM	NM
	12-Aug-2020	6.99	4,530	21.4	NM	NM
	13-May-2020	7.60	3,968	23.5	1.99	121
	10-Feb-2020	7.26	3,860	20.2	10.17	75
	12-Nov-2019	6.89	3,731	20.5	3.04	138
	5-Aug-2019	7.09	3,799	22.7	NM	195
	14-May-2019	6.84	3,648	21.8	1.39	144
	22-Feb-2019	7.19	3,631	21.6	1.79	154
	14-Nov-2018	6.80	3,841	20.6	2.61	136
	15-Aug-2018	7.44	3,602	22.1	2.35	78
	18-May-2018	6.91	3,685	21.10	2.88	68
	9-Feb-2018	7.56	3,808	21.60	3.11	136
	8-Nov-2017	7.29	3,959	21.30	3.54	214
	10-Aug-2017	7.20	3,730	24.20	5.93	179
	17-May-2017	7.08	3,613	21.33	3.82	147.9
	17-Feb-2017	7.18	3,864	20.85	4.48	203.1
	9-Nov-2016	7.46	3,697	21.17	5.25	60.9
	17-Aug-2016	7.42	3,893	24.18	5.51	25.0
18-May-2016	7.04	3,371	21.24	3.27	76.2	
15-Feb-2016	5.37	3,470	21.39	3.54	201.4	
9-Nov-2015	7.11	3,558	21.29	2.40	38.5	
17-Aug-2015	6.84	3,626	22.52	NM	277.8	

**TABLE 2. SUMMARY OF MONITORING WELL GROUNDWATER FIELD PARAMETERS
DONA ANA DAIRIES, DONA ANA COUNTY, NEW MEXICO**

Monitoring Well	Date Measured	pH	SpC (uS/cm)	Temp (°C)	DO (mg/L)	ORP (mV)
126-05	24-May-2023	Insufficient Water-Parameters Not Collected				
	17-Aug-2022	Insufficient Water-Parameters Not Collected				
	5-May-2022	Insufficient Water-Parameters Not Collected				
	24-Feb-2022	7.60	5,020	17.6	3.4	130
	9-Nov-2021	7.65	4,990	21.3	3.0	220
	11-Aug-2021	Insufficient Water-Parameters Not Collected				
	4-May-2021	7.49	5,060	21.3	3.5	262
	9-Feb-2021	7.44	5,320	20.3	3.2	260
	10-Nov-2020	7.41	5,880	20.0	NM	NM
	12-Aug-2020	Insufficient Water-Parameters Not Collected				
	13-May-2020	7.67	5,430	23.7	2.19	99
	10-Feb-2020	7.40	5,362	20.3	4.99	83
	12-Nov-2019	6.84	5,678	19.2	2.88	119
	5-Aug-2019	7.12	5,341	23.2	NM	185
	14-May-2019	7.66	5,250	21.2	1.70	79
	22-Feb-2019	7.41	5,677	20.5	1.51	150
	14-Nov-2018	7.05	5,925	19.9	1.29	140
	15-Aug-2018	7.78	5,495	22.3	1.44	108
	18-May-2018	7.04	5,785	21.20	1.17	107
	9-Feb-2018	7.38	5,767	21.70	1.12	60.0
	8-Nov-2017	7.69	5,571	21.00	1.27	154.0
	10-Aug-2017	7.36	5,397	25.50	3.91	156.0
	17-May-2017	7.43	5,384	22.69	3.03	162.5
	17-Feb-2017	7.42	5,274	19.48	5.78	218.3
	9-Nov-2016	7.66	4,974	21.23	2.52	40.0
	17-Aug-2016	7.56	4,761	23.55	2.86	-78.3
	18-May-2016	7.23	4,409	20.60	3.35	73.7
	15-Feb-2016	6.41	4,654	21.64	4.57	165.0
9-Nov-2015	7.39	4,174	19.96	2.15	186.6	
17-Aug-2015	Insufficient Water-Parameters Not Collected					
126-07	24-May-2023	Insufficient Water-Parameters Not Collected				
	17-Aug-2022	Insufficient Water-Parameters Not Collected				
	5-May-2022	7.02	5,820	23.0	3.1	230
	24-Feb-2022	7.29	5,200	17.5	3.1	158
	9-Nov-2021	7.22	5,080	23.5	2.3	229
	11-Aug-2021	7.33	4,780	21.7	3.1	233
	4-May-2021	7.02	4,840	20.6	3.0	296
	9-Feb-2021	6.95	4,830	21.1	3.3	287
	10-Nov-2020	7.00	4,920	20.4	NM	NM
	12-Aug-2020	6.77	5,000	23.1	NM	NM
	13-May-2020	7.39	4,896	23.5	1.96	133
	7-Feb-2020	6.67	4,455	21.2	7.68	91
	12-Nov-2019	6.35	4,522	20.0	4.83	132
	5-Aug-2019	6.80	4,715	23.5	NM	205
	14-May-2019	7.16	4,588	22.8	1.28	86
	22-Feb-2019	7.00	4,271	21.1	1.54	161
	14-Nov-2018	6.66	4,422	21.0	2.24	140
	15-Aug-2018	7.01	4,333	21.2	1.94	136
	18-May-2018	7.68	4,250	21.90	2.19	121
	9-Feb-2018	6.80	4,114	22.50	2.37	177
	8-Nov-2017	6.78	4,094	21.70	2.21	194
	10-Aug-2017	6.93	4,018	24.40	3.92	173
	17-May-2017	6.85	3,862	22.43	2.35	167.8
	17-Feb-2017	6.96	3,918	22.40	1.49	157.1
	9-Nov-2016	7.23	3,603	21.93	3.89	57.7
	17-Aug-2016	7.03	3,798	23.70	2.42	41.1
	18-May-2016	6.71	3,439	22.08	1.75	94.3
	15-Feb-2016	4.87	3,440	21.28	1.41	208.1
9-Nov-2015	6.84	3,338	21.02	1.84	185.7	
17-Aug-2015	6.80	3,658	24.41	NM	234.8	

**TABLE 2. SUMMARY OF MONITORING WELL GROUNDWATER FIELD PARAMETERS
DONA ANA DAIRIES, DONA ANA COUNTY, NEW MEXICO**

Monitoring Well	Date Measured	pH	SpC (uS/cm)	Temp (°C)	DO (mg/L)	ORP (mV)
126-09	24-May-2023	Insufficient Water-Parameters Not Collected				
	17-Aug-2022					
	5-May-2022					
	24-Feb-2022	7.76	1,618	15.6	6.2	189
	9-Nov-2021	Insufficient Water-Parameters Not Collected				
	11-Aug-2021					
	4-May-2021					
	9-Feb-2021					
	9-Sep-2020					
	10-Nov-2020					
	12-Aug-2020					
	14-May-2020	7.88	2,288	22.9	1.59	108
	7-Feb-2020	7.56	1,219	22.3	7.46	16
	12-Nov-2019	7.53	1,238	19.3	5.21	28
	5-Aug-2019	6.91	1,397	NM	NM	255
	14-May-2019	7.83	1,293	23.2	1.99	66
	22-Feb-2019	6.73	1,429	20.6	2.29	170
	14-Nov-2018	6.75	1,259	21.0	2.16	122
	15-Aug-2018	7.73	1,054	24.7	2.51	125
	18-May-2018	7.83	1,154	21.70	2.23	131
	9-Feb-2018	7.69	1,086	20.20	2.64	150
	8-Nov-2017	7.42	942.1	21.10	5.04	250
	10-Aug-2017	7.37	892.7	27.00	4.64	60
	17-May-2017	7.87	793	22.46	3.48	132.6
	20-Feb-2017	7.85	919	18.64	8.37	190.8
	9-Nov-2016	7.42	3,774	21.09	5.63	55.3
17-Aug-2016	7.74	4,045	23.20	5.85	3.9	
18-May-2016	7.07	3,845	23.15	4.13	66.5	
15-Feb-2016	6.34	3,926	22.52	3.30	184.2	
9-Nov-2015	6.79	3,888	22.27	4.75	193.2	
17-Aug-2015	Insufficient Water-Parameters Not Collected					
126-12	24-May-2023	7.12	3,340	24.3	NM	NM
	17-Aug-2022	7.18	2,910	19.8	NM	NM
	5-May-2022	7.33	3,620	21.7	1.6	185
	24-Feb-2022	7.61	3,380	17.0	3.0	208
	9-Nov-2021	7.66	3,210	20.0	1.9	208
	11-Aug-2021	7.33	3,340	20.9	1.6	223
	4-May-2021	7.46	3,320	20.6	2.2	243
	9-Feb-2021	7.40	3,220	20.5	1.8	205
	10-Nov-2020	7.29	3,590	18.9	NM	NM
	12-Aug-2020	7.19	3,570	23.1	NM	NM
	14-May-2020	7.66	3,400	20.7	1.89	90
	10-Feb-2020	7.46	3,070	19.5	4.80	20
	12-Nov-2019	6.76	3,181	18.5	1.14	106
	5-Aug-2019	7.10	3,415	21.7	NM	158
	14-May-2019	7.41	3,259	19.3	1.44	123
	22-Feb-2019	7.33	3,316	19.6	1.17	115
	14-Nov-2018	7.01	3,512	19.5	1.33	125
	15-Aug-2018	7.18	3,732	20.8	1.06	140
	7-Jun-2018	6.89	3,624	20.8	1.21	102
	9-Feb-2018	7.69	3,716	20.6	1.09	89
	8-Nov-2017	7.59	3,920	20.3	-88	-170
	10-Aug-2017	7.20	4,125	22.4	2.96	141
	17-May-2017	6.94	3,377	19.54	2.71	167.8
	20-Feb-2017	7.40	3,494	20.01	5.76	206.0
	9-Nov-2016	7.43	3,321	19.66	4.18	67.2
	17-Aug-2016	7.29	3,696	22.16	2.40	22.8
18-May-2016	7.12	3,103	19.36	2.26	77.4	
15-Feb-2016	6.30	3,291	21.09	1.88	175.2	
9-Nov-2015	7.24	3,276	19.76	2.37	-145.5	
17-Aug-2015	7.21	1,843	20.97	NM	-177.9	

**TABLE 2. SUMMARY OF MONITORING WELL GROUNDWATER FIELD PARAMETERS
DONA ANA DAIRIES, DONA ANA COUNTY, NEW MEXICO**

Monitoring Well	Date Measured	pH	SpC (uS/cm)	Temp (°C)	DO (mg/L)	ORP (mV)
126-13	24-May-2023	6.88	4,960	23.8	NM	NM
	17-Aug-2022	7.00	5,000	22.2	NM	NM
	5-May-2022	7.13	5,570	21.9	1.9	171
	24-Feb-2022	7.36	5,020	18.7	2.6	214
	9-Nov-2021	7.42	4,830	20.4	2.1	123
	11-Aug-2021	7.32	4,750	22.0	2.3	47
	4-May-2021	7.32	4,910	20.1	3.5	127
	9-Feb-2021	7.28	4,990	18.9	2.4	148
	10-Nov-2020	7.21	4,970	19.6	NM	NM
	12-Aug-2020	6.98	5,180	23.1	NM	NM
	13-May-2020	7.47	5,320	23.2	1.33	56
	7-Feb-2020	7.21	5,039	20.6	9.59	103
	12-Nov-2019	6.61	5,106	20.1	4.62	37
	5-Aug-2019	6.79	5,480	22.8	NM	220
	14-May-2019	6.89	5,297	22.0	1.37	101
	22-Feb-2019	6.62	4,711	20.7	1.29	173
	14-Nov-2018	6.58	5,374	20.8	1.40	146
	15-Aug-2018	7.06	5,136	22.9	1.17	135
	18-May-2018	7.40	5,144	21.20	1.49	60
	9-Feb-2018	7.00	4,810	21.20	1.78	136
	8-Nov-2017	6.96	4,568	21.00	1.13	148
	10-Aug-2017	6.97	4,505	23.30	4.90	128
	17-May-2017	6.99	4,253	21.21	1.87	185.8
	17-Feb-2017	7.06	4,611	20.98	4.72	128.5
	9-Nov-2016	7.31	4,361	21.40	3.84	41.8
17-Aug-2016	7.24	4,447	21.89	2.13	34.0	
18-May-2016	6.86	4,132	20.69	3.01	73.5	
15-Feb-2016	6.38	4,392	21.01	2.18	220.8	
9-Nov-2015	6.96	4,208	21.49	4.32	114.8	
17-Aug-2015	6.81	4,521	22.40	NM	167.3	
Mountain View Dairy						
70-01	8-May-2023	7.23	4,640	22.8	2.91	136
	9-Feb-2023	7.22	4,718	21.6	2.09	154
	8-Nov-2022	7.28	4,825	22.6	2.00	37
	9-Aug-2022	7.31	4,892	23.8	2.53	156
	9-May-2022	7.29	4,923	22.9	2.81	147
	15-Feb-2022	7.41	4,550	21.4	2.46	117
	5-Nov-2021	7.61	4,817	23.3	2.91	87
	10-Aug-2021	7.78	4,480	23.0	2.92	74
	10-May-2021	7.34	4,639	22.6	1.33	141
	16-Feb-2021	7.40	4,570	19.3	2.00	99
	12-Nov-2020	7.39	4,401	21.4	2.63	59
	14-Aug-2020	7.57	5,021	26.3	1.38	143
	13-May-2020	7.39	4,522	24.6	2.03	96
	10-Feb-2020	7.26	4,429	21.4	1.06	69
	15-Nov-2019	6.75	4,766	22.0	2.62	136
	7-Aug-2019	7.01	5,108	22.7	NM	192
	16-May-2019	6.49	4,229	23.6	3.47	88
	26-Feb-2019	7.11	4,577	21.5	2.13	145
	15-Nov-2018	7.01	4,448	20.9	2.61	151
	15-Aug-2018	7.28	5,081	23.7	2.29	186
	21-May-2018	6.77	5,065	22.6	2.52	108
	13-Feb-2018	7.09	4,570	22.7	1.48	181
	9-Nov-2017	6.79	4,166	20.8	2.76	133
	14-Aug-2017	7.08	4,321	23.0	3.10	145
	19-May-2017	6.96	3,831	23.21	1.90	173.4
	20-Feb-2017	7.53	3,953	21.11	4.94	116.9
	22-Nov-2016	7.16	4,160	21.91	1.96	32.6
19-Aug-2016	7.35	3,982	21.67	1.30	61.9	
24-May-2016	7.14	3,734	21.64	2.85	37.7	
16-Feb-2016	6.66	3,771	21.03	2.20	191.9	
12-Nov-2015	7.15	3,774	20.91	1.70	171.1	
19-Aug-2015	7.08	3,830	22.50	NM	187.0	

**TABLE 2. SUMMARY OF MONITORING WELL GROUNDWATER FIELD PARAMETERS
DONA ANA DAIRIES, DONA ANA COUNTY, NEW MEXICO**

Monitoring Well	Date Measured	pH	SpC (uS/cm)	Temp (°C)	DO (mg/L)	ORP (mV)	
70-02	8-May-2023	7.33	4,508	29.3	2.54	88	
	9-Feb-2023	7.28	4,587	22.0	2.33	136	
	8-Nov-2022	7.36	4,668	22.8	2.06	175	
	9-Aug-2022	7.32	4,744	25.7	2.07	157	
	9-May-2022	7.51	4,738	23.4	2.01	102	
	15-Feb-2022	7.70	4,663	22.4	2.60	107	
	5-Nov-2021	7.72	4,637	23.0	2.53	146	
	10-Aug-2021	7.88	4,722	24.0	2.77	71	
	10-May-2021	7.64	4,743	23.0	2.66	117	
	16-Feb-2021	7.61	4,525	20.1	2.29	102	
	12-Nov-2020	7.43	4,518	22.6	2.88	94	
	14-Aug-2020	7.69	4,801	23.8	2.63	1.47	
	13-May-2020	7.60	4,813	24.1	1.70	86	
	10-Feb-2020	7.52	4,540	21.9	0.83	112	
	12-Nov-2019	7.16	4,522	21.1	1.33	157	
	6-Aug-2019	7.17	4,872	24.7	NM	212	
	16-May-2019	7.84	4,765	23.6	5.72	80	
	26-Feb-2019	7.29	4,665	22.2	1.86	147	
	14-Nov-2018	7.11	4,789	21.3	4.15	137	
	15-Aug-2018	7.53	4,744	24.4	3.84	175	
	21-May-2018	7.10	4,802	23.4	4.80	111	
	13-Feb-2018	7.54	4,790	22.3	1.92	150	
	9-Nov-2017	7.11	4,818	21.7	5.60	128	
	14-Aug-2017	7.77	4,890	25.3	3.23	149	
	19-May-2017	7.23	4,716	22.71	3.27	157.8	
	20-Feb-2017	7.81	4,939	22.23	5.27	201.6	
	22-Nov-2016	7.79	4,906	22.01	4.21	65.7	
	18-Aug-2016	Insufficient Water-Parameters Not Collected					
	23-May-2016	7.49	4,846	24.22	2.01	40.2	
	16-Feb-2016	6.90	4,816	22.31	2.57	192.5	
12-Nov-2015	7.64	4,737	21.94	NM	174.1		
19-Aug-2015	7.43	4,816	25.90	NM	179.5		
70-04	8-May-2023	7.34	4,477	23.6	1.93	20	
	9-Feb-2023	7.28	4,610	22.5	2.64	102	
	8-Nov-2022	7.29	4,582	22.60	1.59	146	
	9-Aug-2022	7.54	4,441	23.5	2.85	127	
	9-May-2022	7.58	4,428	23.4	2.33	100	
	15-Feb-2022	7.83	4,460	22.2	2.66	83	
	5-Nov-2021	7.60	4,408	22.3	2.62	158	
	10-Aug-2021	7.54	4,402	23.2	2.38	54	
	10-May-2021	7.50	4,463	23.7	3.35	91	
	16-Feb-2021	7.66	4,326	20.9	2.40	97	
	12-Nov-2020	7.29	4,344	22.8	2.03	87	
	14-Aug-2020	7.24	4,391	27.6	2.05	144	
	13-May-2020	7.68	4,406	23.7	1.93	113	
	10-Feb-2020	7.25	4,400	22.3	1.19	97	
	12-Nov-2019	6.61	4,309	21.4	1.18	113	
	6-Aug-2019	6.74	4,564	23.7	NM	236	
	16-May-2019	6.27	4,521	22.9	3.84	97	
	26-Feb-2019	7.09	4,513	22.4	2.34	145	
	14-Nov-2018	6.75	4,532	21.8	2.58	133	
	15-Aug-2018	7.17	4,401	24.2	2.28	135	
	21-May-2018	7.38	4,612	23.0	2.11	95	
	13-Feb-2018	7.27	4,433	22.6	1.06	138	
	9-Nov-2017	6.68	4,292	21.9	2.47	129	
	14-Aug-2017	7.14	4,229	23.2	5.66	131	
	19-May-2017	6.97	4,077	22.33	3.11	197.8	
	20-Feb-2017	7.42	4,232	22.17	1.24	85.2	
	22-Nov-2016	7.20	4,028	20.35	3.28	87.0	
	18-Aug-2016	7.06	4,147	23.11	1.81	29.1	
	23-May-2016	6.99	3,916	22.93	1.77	66.5	
	16-Feb-2016	6.63	3,930	21.57	1.36	205.3	
12-Nov-2015	7.08	3,939	21.76	1.17	195.5		
19-Aug-2015	7.01	4,047	22.49	NM	183.3		

**TABLE 2. SUMMARY OF MONITORING WELL GROUNDWATER FIELD PARAMETERS
DONA ANA DAIRIES, DONA ANA COUNTY, NEW MEXICO**

Monitoring Well	Date Measured	pH	SpC (uS/cm)	Temp (°C)	DO (mg/L)	ORP (mV)
Buena Vista Dairy I						
86-01	Jan-2011	Not Sampled Since January 2011				
86-02	Jan-2011	Not Sampled Since January 2011				
Bright Star Dairy						
340-01	5-May-2023	7.29	4,514	22.2	2.60	119
	8-Feb-2023	7.26	4,484	20.3	2.23	173
	8-Nov-2022	7.19	4,552	21.3	2.35	200
	27-Oct-2022	7.19	4,507	21.0	2.55	207
	5-May-2022	7.40	4,496	22.0	2.84	157
	14-Feb-2022	7.52	4,411	21.8	2.34	92
	4-Nov-2021	7.30	4,389	21.5	2.64	180
	9-Aug-2021	7.57	4,447	24.7	2.95	83
	6-May-2021	7.43	4,433	23.0	2.93	199
	15-Feb-2021	7.49	4,283	19.6	2.83	50
	11-Nov-2020	7.22	4,254	22.0	2.81	161
	13-Aug-2020	7.59	4,420	23.7	1.93	164
	14-May-2020	7.49	4,430	22.9	2.91	118
	7-Feb-2020	7.45	4,201	21.2	10.22	64
	12-Nov-2019	6.86	4,254	20.7	1.27	142
	6-Aug-2019	7.02	4,458	23.5	NM	158
	14-May-2019	7.12	4,360	22.5	2.23	87
	25-Feb-2019	7.13	4,345	21.1	2.45	129
	15-Nov-2018	7.17	4,455	21.3	2.70	147
	14-Aug-2018	7.19	4,321	23.6	1.60	128
	21-May-2018	6.68	4,484	23.4	1.03	105
	12-Feb-2018	7.32	4,409	21.2	1.09	124
	8-Nov-2017	7.56	4,342	21.1	2.47	113
	11-Aug-2017	7.29	4,350	23.0	1.93	157.2
	18-May-2017	7.08	4,140	21.83	2.61	181.2
	16-Feb-2017	7.27	4,299	20.79	3.68	173.1
10-Nov-2016	7.45	4,244	20.80	2.67	106.8	
23-Aug-2016	7.07	4,391	21.95	1.27	30.4	
18-May-2016	7.09	4,122	22.25	1.76	61.3	
11-Feb-2016	7.36	4,093	21.35	3.07	207.3	
9-Nov-2015	7.25	4,052	21.27	1.34	115.1	
20-Aug-2015	7.26	3,382	22.21	NM	259.1	

**TABLE 2. SUMMARY OF MONITORING WELL GROUNDWATER FIELD PARAMETERS
DONA ANA DAIRIES, DONA ANA COUNTY, NEW MEXICO**

Monitoring Well	Date Measured	pH	SpC (uS/cm)	Temp (°C)	DO (mg/L)	ORP (mV)
340-02	5-May-2023	Dry				
	8-Feb-2023	Insufficient Water-Parameters Not Collected				
	8-Nov-2022	Insufficient Water-Parameters Not Collected				
	9-Aug-2022	7.13	4,855	23.7	2.88	209
	5-May-2022	7.47	4,860	27.8	2.73	100
	14-Feb-2022	7.44	4,781	22.8	2.73	74
	4-Nov-2021	7.66	4,869	22.5	2.77	144
	9-Aug-2021	7.79	4,828	23.4	2.77	72
	6-May-2021	7.52	4,947	24.0	2.33	189
	15-Feb-2021	7.55	4,946	19.5	2.57	88
	11-Nov-2020	7.20	4,923	23.3	2.90	121
	14-Aug-2020	7.35	4,910	24.6	2.11	128
	14-May-2020	7.70	4,888	23.9	2.73	80
	7-Feb-2020	7.21	4,706	22.1	3.96	66
	12-Nov-2019	6.97	4,783	20.7	3.41	174
	6-Aug-2019	6.98	4,770	25.6	NM	189
	14-May-2019	7.37	4,700	24.5	1.59	66
	25-Feb-2019	7.08	4,714	22.1	1.20	124
	15-Nov-2018	6.93	4,863	21.9	1.41	161
	14-Aug-2018	7.22	4,827	24.4	2.94	131
	21-May-2018	6.86	4,883	23.1	3.01	121
	12-Feb-2018	7.34	4,899	22.2	3.90	123
	8-Nov-2017	6.19	5,022	22.4	3.80	36
	11-Aug-2017	7.75	4,950	26.6	5.91	189
	18-May-2017	7.28	4,948	23.0	2.97	187.6
	16-Feb-2017	7.35	5,096	21.65	8.01	200.5
10-Nov-2016	7.55	4,904	20.96	7.16	113.8	
23-Aug-2016	Insufficient Water-Parameters Not Collected					
18-May-2016	Insufficient Water-Parameters Not Collected					
11-Feb-2016	7.30	4,890	22.59	5.44	217.5	
9-Nov-2015	7.10	4,755	22.34	4.09	148.9	
20-Aug-2015	Insufficient Water-Parameters Not Collected					
Dominguez 2 (Former D&J Dairy)						
42-02*	10-May-2023	7.28	3,961	20.1	2.07	152
	13-Feb-2023	7.21	4,119	19.5	2.23	162
	10-Nov-2022	7.21	3,910	19.1	2.93	187
	11-Aug-2022	7.24	3,840	20.6	2.92	176
	11-May-2022	7.31	3,990	21.1	2.69	185
	16-Feb-2022	7.61	4,144	19.9	2.12	131
	9-Nov-2021	7.11	3,982	19.6	2.37	206
	11-Aug-2021	7.70	3,866	21.5	2.95	112
	11-May-2021	7.36	3,951	20.4	2.90	204
	18-Feb-2021	7.65	4,047	18.4	1.79	249
	16-Nov-2020	7.43	3,915	19.9	2.37	260
	18-Aug-2020	7.63	3,591	20.9	2.55	235
	22-May-2020	7.32	3,781	20.2	2.91	116
	11-Feb-2020	7.60	3,705	18.0	2.08	71
	22-Nov-2019	6.80	3,672	19.8	6.50	177
	16-Aug-2019	6.94	3,606	20.4	6.35	44
	29-May-2019	6.96	3,866	20.8	4.23	256
	6-Mar-2019	6.86	3,731	19.1	4.67	167
	4-Dec-2018	6.88	3,558	17.8	4.77	173
	22-Aug-2018	7.01	3,749	21.0	4.38	165
	29-May-2018	6.84	4,326	20.1	5.45	142
	21-Feb-2018	7.12	4,248	18.8	7.30	167
	1-Dec-2017	7.06	4,086	19.4	8.58	189
	22-Aug-2017	7.20	3,877	20.8	6.28	73
	2-Jun-2017	7.02	3,769	20.18	4.25	135.5
	6-Mar-2017	7.28	3,729	19.44	4.76	221.2
	28-Nov-2016	7.08	3,698	19.07	3.76	110.2
	31-Aug-2016	7.09	3,787	21.70	4.38	70.7
	1-Jun-2016	7.07	3,399	20.65	7.02	48.4
	23-Feb-2016	6.71	3,376	19.57	5.18	208.7
1-Dec-2015	7.32	3,424	19.70	7.41	262.0	
26-Aug-2015	7.03	3,432	21.70	NM	238.8	

**TABLE 2. SUMMARY OF MONITORING WELL GROUNDWATER FIELD PARAMETERS
DONA ANA DAIRIES, DONA ANA COUNTY, NEW MEXICO**

Monitoring Well	Date Measured	pH	SpC (uS/cm)	Temp (°C)	DO (mg/L)	ORP (mV)
42-03*	9-May-2023	7.26	5,034	25.4	2.83	157
	10-Feb-2023	7.19	5,037	24.5	2.45	181
	9-Nov-2022	7.20	5,050	24.6	2.62	190
	10-Aug-2022	7.22	5,141	26.5	1.29	176
	10-May-2022	7.28	5,123	25.9	2.46	178
	16-Feb-2022	7.20	5,009	24.1	1.99	186
	8-Nov-2021	7.20	5,108	26.1	2.90	234
	10-Aug-2021	7.63	5,103	26.9	2.78	64
	11-May-2021	7.22	5,103	26.0	2.96	142
	17-Feb-2021	7.73	4,953	23.7	2.93	131
	16-Nov-2020	7.19	5,048	25.5	2.04	152
	18-Aug-2020	7.37	5,263	26.0	2.83	197
	20-May-2020	7.22	5,220	26.0	2.08	152
	11-Feb-2020	7.75	5,015	22.9	1.58	99
	22-Nov-2019	6.38	5,054	24.6	2.75	88
	16-Aug-2019	6.83	5,376	27.0	2.36	72
	30-May-2019	6.53	5,218	24.9	5.28	208
	6-Mar-2019	7.22	4,511	24.9	5.54	151
	4-Dec-2018	6.90	5,211	23.3	5.39	180
	22-Aug-2018	7.01	5,352	27.1	5.81	88
	29-May-2018	6.64	5,528	25.7	6.21	120
	21-Feb-2018	7.12	5,486	22.6	6.37	147
	1-Dec-2017	7.11	5,502	24.6	7.28	147
	23-Aug-2017	7.14	5,500	26.0	4.27	127
	2-Jun-2017	7.01	5,809	25.36	5.21	118.7
	6-Mar-2017	7.25	5,975	24.20	3.73	202.6
	28-Nov-2016	6.59	5,902	24.49	7.23	116.1
	31-Aug-2016	6.98	5,556	26.70	6.74	55.4
	1-Jun-2016	6.92	5,322	24.17	4.78	65.8
	23-Feb-2016	6.73	5,403	22.87	4.17	204.4
1-Dec-2015	7.21	4,736	20.46	5.68	149.8	
26-Aug-2015	6.97	5,861	25.81	NM	236.5	

**TABLE 2. SUMMARY OF MONITORING WELL GROUNDWATER FIELD PARAMETERS
DONA ANA DAIRIES, DONA ANA COUNTY, NEW MEXICO**

Monitoring Well	Date Measured	pH	SpC (uS/cm)	Temp (°C)	DO (mg/L)	ORP (mV)
42-06*	9-May-2023	7.30	3,658	21.7	2.84	137
	10-Feb-2023	7.31	3,669	18.9	2.86	114
	9-Nov-2022	7.43	3,605	21.20	2.86	226.0
	10-Aug-2022	7.36	3,666	22.6	2.88	191
	10-May-2022	7.43	4,799	22.2	2.11	138
	17-Feb-2022	7.40	4,982	20.1	2.39	191
	8-Nov-2021	7.48	5,003	21.6	2.86	139
	11-Aug-2021	7.80	4,934	22.6	2.77	105
	11-May-2021	7.72	5,282	21.8	2.97	-41
	18-Feb-2021	7.85	5,265	21.0	2.49	118
	16-Nov-2020	7.77	4,600	21.5	2.85	246
	22-May-2020	7.40	4,422	21.6	2.90	103
	12-Feb-2020	7.87	4,036	20.1	2.13	104
	22-Nov-2019	7.18	3,830	20.2	5.70	112
	16-Aug-2019	7.31	4,144	21.4	3.45	45
	30-May-2019	7.17	3,631	21.3	4.11	206
	6-Mar-2019	7.32	4,071	21.4	4.30	146
	4-Dec-2018	7.11	4,010	19.3	4.50	182
	22-Aug-2018	7.04	4,029	21.5	4.11	189
	29-May-2018	7.14	4,490	21.0	3.76	132
	21-Feb-2018	7.66	4,349	20.1	4.28	160
	1-Dec-2017	7.31	4,034	21.1	7.12	152
	22-Aug-2017	7.70	4,448	22.1	5.06	74
	2-Jun-2017	7.11	3,441	21.47	123.4	94.8
	6-Mar-2017	7.71	3,171	21.41	5.29	208.9
	28-Nov-2016	7.12	2,947	20.63	8.32	200.7
31-Aug-2016	7.42	2,932	22.70	6.96	33.5	
1-Jun-2016	7.41	2,996	21.17	6.10	44.5	
23-Feb-2016	7.52	3,092	18.97	2.45	95.4	
1-Dec-2015	7.68	3,042	18.65	6.21	188.1	
26-Aug-2015	7.39	3,551	23.21	NM	232.7	
42-07*	10-Nov-2020	Plugged and Abandoned				
	19-Aug-2020	Dry				
	22-May-2020	Dry				
	11-Feb-2020	Dry				
	16-Aug-2019	Dry				
	16-Aug-2019	Dry				
	29-May-2019	Dry				
	6-Mar-2019	Dry				
	4-Dec-2018	Dry				
	22-Aug-2018	Dry				
	29-May-2018	Dry				
	21-Feb-2018	Dry				
	1-Dec-2017	Dry				
	22-Aug-2017	Dry				
	2-Jun-2017	Dry				
	6-Mar-2017	Dry				
	28-Nov-2016	Dry				
31-Aug-2016	Dry					
1-Jun-2016	Dry					
23-Feb-2016	Dry					
1-Dec-2015	Dry					
26-Aug-2015	Dry					

**TABLE 2. SUMMARY OF MONITORING WELL GROUNDWATER FIELD PARAMETERS
DONA ANA DAIRIES, DONA ANA COUNTY, NEW MEXICO**

Monitoring Well	Date Measured	pH	SpC (uS/cm)	Temp (°C)	DO (mg/L)	ORP (mV)	
42-08*	10-May-2023	7.25	3,015	24.2	2.16	256	
	13-Feb-2023	7.33	2,792	15.3	2.16	273	
	9-Nov-2022	7.32	3,305	22.0	2.57	219.0	
	10-Aug-2022	7.65	3,326	26.7	2.50	152	
	11-May-2022	7.31	2,823	21.3	2.00	181	
	17-Feb-2022	7.30	2,869	20.7	2.06	181	
	9-Nov-2021	7.25	3,141	23.9	2.23	208	
	11-Aug-2021	7.81	3,191	22.1	2.16	117	
	11-May-2021	7.75	3,077	21.6	1.68	238	
	18-Feb-2021	7.81	2,630	19.6	2.02	148	
	16-Nov-2020	7.65	2,775	21.9	2.55	282	
	18-Aug-2020	7.82	3,477	23.3	2.40	-225	
	22-May-2020	7.57	2,681	23.5	2.14	140	
	12-Feb-2020	8.03	2,586	16.3	4.93	79	
	22-Nov-2019	7.27	2,751	21.7	6.39	135	
	16-Aug-2019	7.39	2,675	21.2	2.11	39	
	29-May-2019	7.58	2,106	21.1	4.09	192	
	6-Mar-2019	7.54	1,944	20.5	3.81	147	
	4-Dec-2018	7.36	1,881	19.9	4.08	155	
	22-Aug-2018	7.65	2,490	21.5	3.94	198	
	29-May-2018	7.32	1,857	21.3	3.70	131	
	21-Feb-2018	7.90	1,962	20.3	3.91	150	
	1-Dec-2017	7.98	2,082	21.0	3.83	162	
	22-Aug-2017	7.61	2,410	21.6	3.91	89	
	2-Jun-2017	7.55	1,691	21.45	4.36	93.6	
	6-Mar-2017	7.85	1,626	20.48	2.72	195.1	
	28-Nov-2016	7.94	1,684	18.10	6.11	47.50	
	31-Aug-2016	Dry					
	1-Jun-2016	Dry					
	23-Feb-2016	Dry					
1-Dec-2015	Dry						
26-Aug-2015	7.74	2,245	22.68	NM	206.6		

**TABLE 2. SUMMARY OF MONITORING WELL GROUNDWATER FIELD PARAMETERS
DONA ANA DAIRIES, DONA ANA COUNTY, NEW MEXICO**

Monitoring Well	Date Measured	pH	SpC (uS/cm)	Temp (°C)	DO (mg/L)	ORP (mV)
42-09*	10-Nov-2020	Plugged and Abandoned				
	1-Dec-2015	Destroyed				
	26-Aug-2015	7.12	4,773	24.28	NM	245.8
42-10*	11-May-2023	7.30	2,633	29.6	2.00	110
	14-Feb-2023	7.30	2,684	26.5	1.88	132
	10-Nov-2022	7.27	2,636	27.4	1.99	213
	11-Aug-2022	7.28	2,477	27.5	1.61	146
	11-May-2022	7.43	2,607	27.8	1.91	148
	17-Feb-2022	7.20	2,496	23.8	1.75	155
	9-Nov-2021	7.19	2,508	27.7	1.85	149
	12-Aug-2021	7.53	2,451	28.4	1.78	83
	12-May-2021	7.52	2,446	26.9	1.79	164
	17-Feb-2021	7.68	2,355	25.9	1.75	119
	13-Nov-2020	7.44	2,324	27.4	1.73	217
	19-Aug-2020	7.14	2,431	28.2	1.78	165
	22-May-2020	7.50	2,455	28.2	1.75	156
	12-Feb-2020	7.31	2,389	25.8	4.85	118
	25-Nov-2019	6.66	2,433	26.9	6.21	199
	19-Aug-2019	6.83	2,488	27.5	6.25	138
	30-May-2019	6.71	2,390	27.1	4.64	131
	6-Mar-2019	7.14	2,391	26.9	5.28	131
	4-Dec-2018	6.82	2,304	22.9	5.63	190
	22-Aug-2018	7.29	2,294	27.9	6.23	151
	30-May-2018	6.65	2,308	27.0	7.30	157
	19-Feb-2018	7.29	2,291	24.9	7.71	136
	4-Dec-2017	7.52	2,250	24.7	7.84	171
	23-Aug-2017	7.33	2,256	26.1	5.61	132
	2-Jun-2017	7.18	2,381	27.3	5.36	119.4
	6-Mar-2017	7.26	2,450	25.77	6.32	195.8
	29-Nov-2016	6.96	2,473	24.61	11.24	113.6
	1-Sep-2016	6.96	2,300	27.70	6.63	NM
1-Jun-2016	7.10	2,300	26.84	5.27	72.3	
23-Feb-2016	7.38	2,072	18.76	3.27	201.8	
1-Dec-2015	7.46	2,222	22.17	7.39	167.4	
25-Aug-2015	7.20	2,565	27.01	NM	220.5	

**TABLE 2. SUMMARY OF MONITORING WELL GROUNDWATER FIELD PARAMETERS
DONA ANA DAIRIES, DONA ANA COUNTY, NEW MEXICO**

Monitoring Well	Date Measured	pH	SpC (uS/cm)	Temp (°C)	DO (mg/L)	ORP (mV)
42-11*	10-May-2023	7.43	2,286	25.6	1.72	110
	14-Feb-2023	7.25	2,309	28.7	1.68	197
	10-Nov-2022	7.35	2,296	25.0	1.78	212
	11-Aug-2022	7.36	2,305	28.9	1.73	166
	11-May-2022	7.36	2,340	31.2	1.66	251
	17-Feb-2022	7.63	2,315	26.9	1.62	168
	9-Nov-2021	7.38	2,281	30.2	1.62	8
	12-Aug-2021	7.24	2,260	29.2	1.65	109
	12-May-2021	7.19	2,246	29.7	1.54	146
	17-Feb-2021	7.19	2,178	28.5	1.48	194
	13-Nov-2020	7.33	2,079	28.0	1.48	256
	19-Aug-2020	7.33	2,071	29.0	1.39	225
	22-May-2020	7.31	2,028	28.5	1.48	152
	12-Feb-2020	7.62	1,903	26.0	1.88	143
	25-Nov-2019	6.63	1,890	28.5	7.49	265
	19-Aug-2019	7.18	1,933	25.8	4.00	134
	30-May-2019	7.13	1,857	24.9	5.56	247
	6-Mar-2019	7.30	1,949	25.8	5.94	130
	4-Dec-2018	7.56	1,918	23.8	6.18	156
	22-Aug-2018	7.78	1,915	27.1	7.15	67
	30-May-2018	6.89	1,921	27.7	6.91	173
	19-Feb-2018	7.31	1,997	26.9	7.60	135
	4-Dec-2017	7.26	1,864	25.4	7.49	170
	23-Aug-2017	7.23	1,888	23.2	6.11	70
	2-Jun-2017	7.20	1,974	27.4	5.74	112.3
	3-Mar-2017	7.20	2,118	26.55	3.61	251.2
	29-Nov-2016	7.16	1,926	22.94	8.17	182.8
	1-Sep-2016	7.22	1,940	25.70	7.01	NM
	1-Jun-2016	7.29	1,868	24.19	6.63	46.6
	23-Feb-2016	7.37	1,732	17.26	6.38	182.1
1-Dec-2015	7.49	1,892	24.59	5.89	140.5	
25-Aug-2015	7.37	2,112	28.24	NM	172.7	
42-12*	11-May-2023	7.28	1,762	26.4	1.30	150
	14-Feb-2023	7.29	1,805	28.6	1.31	34
	1-Nov-2022	7.41	1,812	26.10	1.31	-166
	11-Aug-2022	7.54	1,808	29.5	1.30	145
	11-May-2022	7.56	1,822	31.0	1.31	154
	17-Feb-2022	7.51	1,820	28.6	1.31	144
	9-Nov-2021	7.41	1,826	30.2	1.31	217
	12-Aug-2021	7.38	1,826	31.4	1.28	97
	12-May-2021	7.43	1,837	29.2	1.32	144
	17-Feb-2021	7.39	1,819	28.6	1.29	72
	13-Nov-2020	7.55	1,830	26.8	1.34	259
	19-Aug-2020	7.58	1,910	30.7	1.35	191
	22-May-2020	7.39	1,918	30.5	1.38	173
	12-Feb-2020	7.65	1,850	27.7	5.06	138
	25-Nov-2019	7.21	1,866	28.4	7.58	184
	19-Aug-2019	7.47	1,940	25.1	5.14	136
	30-May-2019	7.38	1,940	25.7	6.10	270
	6-Mar-2019	7.23	1,988	28.7	6.57	127
	4-Dec-2018	7.25	1,972	22.8	6.61	183
	22-Aug-2018	7.50	1,945	26.9	6.39	182
	30-May-2018	7.23	2,034	28.5	6.75	163
	19-Feb-2018	7.31	2,046	25.8	7.02	149
	4-Dec-2017	8.25	1,900	27.1	7.24	159
	23-Aug-2017	7.50	1,888	26.4	5.48	111
	2-Jun-2017	7.31	2,164	29.07	6.05	115.4
	6-Mar-2017	7.45	2,239	27.71	4.58	240.2
	29-Nov-2016	7.19	2,148	24.24	11.03	226.7
	1-Sep-2016	7.15	2,060	25.70	6.83	NM
	1-Jun-2016	7.24	2,039	27.54	5.66	78.6
	23-Feb-2016	7.13	1,980	23.55	7.13	212.0
1-Dec-2015	7.73	1,893	22.11	7.43	149.0	
25-Aug-2015	7.33	2,204	28.36	NM	201.8	

**TABLE 2. SUMMARY OF MONITORING WELL GROUNDWATER FIELD PARAMETERS
DONA ANA DAIRIES, DONA ANA COUNTY, NEW MEXICO**

Monitoring Well	Date Measured	pH	SpC (uS/cm)	Temp (°C)	DO (mg/L)	ORP (mV)	
42-13*	9-May-2023	7.29	4,524	24.1	2.62	112	
	10-Feb-2023	7.21	5,134	25.2	2.05	111	
	9-Nov-2022	7.25	5,108	24.60	2.09	281.0	
	10-Aug-2022	7.25	5,113	26.3	2.19	316	
	10-May-2022	7.22	5,340	27.0	2.78	150	
	16-Feb-2022	7.29	5,211	23.1	1.25	161	
	8-Nov-2021	7.41	5,080	23.1	2.35	232	
	11-Aug-2021	7.14	5,186	23.5	2.32	115	
	11-May-2021	7.51	5,254	23.0	2.11	125	
	17-Feb-2021	7.63	5,399	21.6	2.33	107	
	16-Nov-2020	7.38	5,398	22.9	1.44	89	
	18-Aug-2020	7.15	5,591	22.9	1.19	185	
	22-May-2020	7.61	5,551	21.8	1.88	193	
	11-Feb-2020	7.63	5,220	21.2	1.65	172	
	22-Nov-2019	6.47	5,257	22.4	3.59	224	
	16-Aug-2019	Dry/Water Level Below Pump					
	29-May-2019	Dry/Water Level Below Pump					
	6-Mar-2019	7.32	4,217	20.0	4.43	156	
	4-Dec-2018	Dry/Water Level Below Pump					
	22-Aug-2018	7.27	5,419	25.2	5.38	10.0	
	29-May-2018	7.12	5,395	22.2	5.29	151	
	21-Feb-2018	7.47	5,452	21.1	5.65	156	
	1-Dec-2017	7.14	5,320	21.1	2.65	176	
	23-Aug-2017	Pump Not Operational					
	2-Jun-2017	Pump Not Operational					
	6-Mar-2017	7.71	5,085	20.57	5.42	286.3	
	28-Nov-2016	7.11	4,947	19.98	NM	163.7	
	31-Aug-2016	Pump Not Operational					
	1-Jun-2016	Pump Not Operational					
	23-Feb-2016	Dry/Water Level Below Pump					
1-Dec-2015	Dry/Water Level Below Pump						
26-Aug-2015	7.09	5,190	25.31	NM	221.7		

**TABLE 2. SUMMARY OF MONITORING WELL GROUNDWATER FIELD PARAMETERS
DONA ANA DAIRIES, DONA ANA COUNTY, NEW MEXICO**

Monitoring Well	Date Measured	pH	SpC (uS/cm)	Temp (°C)	DO (mg/L)	ORP (mV)
Dominguez Dairy						
624-01	12-May-2023	7.23	4,321	21.2	1.31	157
	16-Feb-2023	7.26	4,350	19.3	2.25	183
	11-Nov-2022	7.25	4,482	20.2	2.38	193
	12-Aug-2022	7.21	4,375	21.2	2.32	188
	12-May-2022	7.41	4,117	21.2	1.35	217
	18-Feb-2022	7.54	3,690	22.0	2.65	170
	10-Nov-2021	7.71	3,540	22.2	2.60	153
	13-Aug-2021	7.80	4,030	22.1	2.89	116
	14-May-2021	7.58	3,184	22.0	2.39	161
	18-Feb-2021	7.70	3,015	21.8	2.31	141
	13-Nov-2020	7.19	3,126	20.6	2.39	212
	17-Aug-2020	7.43	3,129	22.6	2.36	197
	15-May-2020	7.03	3,468	22.2	NM	162
	12-Feb-2020	7.35	3,009	19.3	2.20	101
	15-Nov-2019	6.68	3,415	21.1	2.44	149
	13-Aug-2019	7.00	3,849	22.1	2.84	83
	20-May-2019	6.48	4,521	21.1	3.48	162
	28-Feb-2019	7.09	4,459	20.7	2.40	167
	20-Nov-2018	7.20	3,459	21.3	2.74	116
	29-Aug-2018	6.96	4,521	21.4	1.60	191
	22-May-2018	6.68	5,126	20.2	2.11	132
	14-Feb-2018	7.15	4,830	20.8	4.37	161
	14-Nov-2017	6.90	4,923	19.9	5.64	59
	15-Aug-2017	7.13	5,031	22.4	5.61	162
	23-May-2017	6.78	4,965	21.07	2.76	169
	22-Feb-2017	7.11	4,816	21.23	6.17	224.3
	14-Nov-2016	7.27	4,854	20.71	4.96	158.3
	19-Aug-2016	7.15	4,500	20.81	4.57	34.7
19-May-2016	6.92	4,002	21.11	5.50	86.6	
16-Feb-2016	6.64	3,664	21.47	5.88	184.6	
10-Nov-2015	7.20	4,741	20.20	3.83	181.7	
7-Aug-2015	6.96	4,585	21.49	2.59	3.8	

**TABLE 2. SUMMARY OF MONITORING WELL GROUNDWATER FIELD PARAMETERS
DONA ANA DAIRIES, DONA ANA COUNTY, NEW MEXICO**

Monitoring Well	Date Measured	pH	SpC (uS/cm)	Temp (°C)	DO (mg/L)	ORP (mV)
624-02	12-May-2023	7.39	4,222	20.7	2.82	107
	16-Feb-2023	7.39	4,208	20.1	2.18	190
	11-Nov-2022	7.22	4,278	20.10	2.70	207.0
	12-Aug-2022	7.29	4,885	23.0	2.73	160
	12-May-2022	7.40	5,113	20.3	2.40	202
	18-Feb-2022	7.48	4,811	19.5	2.73	162
	11-Nov-2021	7.76	3,640	20.3	2.69	168
	13-Aug-2021	7.77	3,655	21.2	2.63	116
	14-May-2021	7.90	3,605	20.9	2.74	199
	19-Feb-2021	7.50	3,668	19.5	2.82	130
	12-Nov-2020	7.67	3,335	21.8	2.76	129
	17-Aug-2020	7.45	3,620	22.3	2.09	155
	15-May-2020	7.37	3,500	20.9	2.08	161
	12-Feb-2020	7.36	3,206	19.8	3.12	126
	15-Nov-2019	6.52	3,629	20.0	1.70	134
	13-Aug-2019	6.81	4,463	20.6	1.33	118
	20-May-2019	6.35	4,262	20.2	4.11	153
	28-Feb-2019	6.90	4,017	19.8	2.58	172
	20-Nov-2018	7.04	4,619	19.3	2.66	131
	28-Aug-2018	6.99	4,248	21.8	1.34	178
	22-May-2018	6.76	4,955	20.0	1.67	105
	14-Feb-2018	7.06	4,335	20.8	2.31	149
	14-Nov-2017	6.74	4,248	19.9	2.80	102
	15-Aug-2017	7.08	4,563	20.4	2.95	138
	23-May-2017	6.61	4,368	20.39	2.41	149.1
	22-Feb-2017	7.03	4,238	19.96	4.31	223.1
	14-Nov-2016	7.28	4,135	20.04	1.86	89.4
	19-Aug-2016	7.15	3,695	19.11	1.37	32.5
19-May-2016	6.81	4,410	19.92	2.07	73.1	
16-Feb-2016	6.34	3,845	20.28	1.52	189.2	
10-Nov-2015	7.20	3,548	18.15	1.69	90.4	
7-Aug-2015	7.07	4,158	22.03	1.94	74.8	
624-04	28-Jan-2020	Plugged and Abandoned				
	15-Nov-2019	Dry				
	13-Aug-2019	Dry				
	20-May-2019	Dry				
	28-Feb-2019	Dry				
	20-Nov-2018	Dry				
	29-Aug-2018	Dry				
	22-May-2018	Dry				
	14-Feb-2018	Dry				
	14-Nov-2017	Dry				
	15-Aug-2017	Dry				
	23-May-2017	Dry				
	22-Feb-2017	Dry				
	14-Nov-2016	Dry				
	19-Aug-2016	Dry				
19-May-2016	Dry					
16-Feb-2016	Dry					
10-Nov-2015	Dry					
7-Aug-2015	Dry					

**TABLE 2. SUMMARY OF MONITORING WELL GROUNDWATER FIELD PARAMETERS
DONA ANA DAIRIES, DONA ANA COUNTY, NEW MEXICO**

Monitoring Well	Date Measured	pH	SpC (uS/cm)	Temp (°C)	DO (mg/L)	ORP (mV)
624-05	28-Jan-2020	Plugged and Abandoned				
	15-Nov-2019	6.85	2,962	21.2	3.12	137
	13-Aug-2019	7.45	3,044	24.4	2.96	97
	16-May-2019	7.66	2,901	21.5	3.07	83
	28-Feb-2019	7.80	2,931	18.5	3.45	158
	20-Nov-2018	Dry				
	29-Aug-2018	Dry				
	22-May-2018	Dry				
	14-Feb-2018	Dry				
	14-Nov-2017	Dry				
	15-Aug-2017	Dry				
	23-May-2017	Dry				
	22-Feb-2017	Dry				
	14-Nov-2016	Dry				
	19-Aug-2016	Dry				
	19-May-2016	Dry				
	16-Feb-2016	Dry				
	10-Nov-2015	Dry				
	7-Aug-2015	Dry				
	624-06	28-Jan-2020	Plugged and Abandoned			
15-Nov-2019		Dry				
13-Aug-2019		Dry				
20-May-2019		Dry				
28-Feb-2019		Dry				
20-Nov-2018		Dry				
29-Aug-2018		Dry				
22-May-2018		Dry				
14-Feb-2018		Dry				
14-Nov-2017		Dry				
15-Aug-2017		Dry				
23-May-2017		Dry				
22-Feb-2017		Dry				
14-Nov-2016		Dry				
19-Aug-2016		Dry				
19-May-2016		Dry				
16-Feb-2016		Dry				
10-Nov-2015		Dry				
7-Aug-2015		Dry				
624-07		28-Jan-2020	Plugged and Abandoned			
	15-Nov-2019	Dry				
	13-Aug-2019	Dry				
	20-May-2019	Dry				
	28-Feb-2019	Dry				
	20-Nov-2018	Dry				
	29-Aug-2018	Dry				
	22-May-2018	Dry				
	14-Feb-2018	Dry				
	14-Nov-2017	Dry				
	15-Aug-2017	Insufficient Water-Parameters Not Collected				
	23-May-2017	Insufficient Water-Parameters Not Collected				
	22-Feb-2017	Insufficient Water-Parameters Not Collected				
	14-Nov-2016	Insufficient Water-Parameters Not Collected				
	19-Aug-2016	Insufficient Water-Parameters Not Collected				
	19-May-2016	Insufficient Water-Parameters Not Collected				
	16-Feb-2016	Dry				
	10-Nov-2015	Insufficient Water-Parameters Not Collected				
	7-Aug-2015	Insufficient Water-Parameters Not Collected				

**TABLE 2. SUMMARY OF MONITORING WELL GROUNDWATER FIELD PARAMETERS
DONA ANA DAIRIES, DONA ANA COUNTY, NEW MEXICO**

Monitoring Well	Date Measured	pH	SpC (uS/cm)	Temp (°C)	DO (mg/L)	ORP (mV)
624-08	28-Jan-2020	Plugged and Abandoned				
	15-Nov-2019	Dry				
	13-Aug-2019	Dry				
	16-May-2019	Dry				
	28-Feb-2019	Dry				
	20-Nov-2018	Dry				
	29-Aug-2018	Dry				
	22-May-2018	Dry				
	14-Feb-2018	Dry				
	14-Nov-2017	Dry				
	15-Aug-2017	Dry				
	23-May-2017	Dry				
	22-Feb-2017	Dry				
	14-Nov-2016	Dry				
	19-Aug-2016	Dry				
	19-May-2016	Dry				
	16-Feb-2016	Dry				
	10-Nov-2015	Dry				
	7-Aug-2015	Dry				
624-09	11-May-2023	7.27	2,273	21.0	1.70	56
	16-Feb-2023	7.22	1,807	19.2	1.37	152
	14-Nov-2022	7.26	1,593	20.1	1.17	167
	15-Aug-2022	7.19	1,791	21.4	1.36	126
	13-May-2022	7.25	2,744	20.5	2.22	197
	18-Feb-2022	7.79	2,804	19.9	2.16	116
	10-Nov-2021	7.18	3,050	20.1	2.44	253
	12-Aug-2021	7.75	3,110	22.9	2.27	115
	12-May-2021	7.67	3,562	20.8	2.89	138
	19-Feb-2021	7.82	4,212	20.1	2.54	128
	13-Nov-2020	7.41	2,315	21.2	1.66	169
	17-Aug-2020	7.66	2,935	23.9	2.15	155
	14-May-2020	7.63	2,829	21.9	2.91	103
	13-Feb-2020	7.70	3,180	19.3	2.93	183
624-10	11-May-2023	7.33	4,581	19.4	1.43	77
	16-Feb-2023	7.25	4,138	18.1	2.71	128
	14-Nov-2022	7.25	4,086	18.8	1.42	174
	12-Aug-2022	7.33	3,866	21.0	2.94	168
	12-May-2022	7.69	3,577	19.6	2.70	152
	18-Feb-2022	7.61	3,296	19.7	2.51	142
	10-Nov-2021	7.62	3,398	18.9	2.56	197
	12-Aug-2021	7.83	3,111	21.3	2.14	106
	12-May-2021	7.47	3,300	19.9	2.44	162
	19-Feb-2021	7.64	4,022	18.9	2.92	128
	13-Nov-2020	7.20	3,573	19.5	2.56	179
	17-Aug-2020	7.64	3,500	23.5	2.40	138
	14-May-2020	7.89	3,883	21.3	2.85	93
13-Feb-2020	8.03	3,913	18.4	2.66	102	
624-11	12-May-2023	7.19	5,738	21.7	2.55	154
	17-Feb-2023	7.23	5,619	20.0	1.19	196
	11-Nov-2022	7.18	5,667	20.9	2.52	198
	12-Aug-2022	7.23	5,276	22.1	1.34	202
	12-May-2022	7.19	5,246	21.1	1.74	193
	18-Feb-2022	7.18	5,195	20.6	1.54	202
	11-Nov-2021	7.66	5,245	21.3	2.10	238
	13-Aug-2021	7.73	5,233	22.3	1.79	87
	14-May-2021	7.42	5,386	22.3	2.31	203
	19-Feb-2021	7.27	5,296	19.7	2.50	200
	12-Nov-2020	7.52	5,160	21.5	1.94	119
	17-Aug-2020	7.72	5,404	22.9	2.21	205
	15-May-2020	7.59	5,467	22.2	2.12	195
	13-Feb-2020	7.49	4,506	20.3	1.69	102

**TABLE 2. SUMMARY OF MONITORING WELL GROUNDWATER FIELD PARAMETERS
DONA ANA DAIRIES, DONA ANA COUNTY, NEW MEXICO**

Monitoring Well	Date Measured	pH	SpC (uS/cm)	Temp (°C)	DO (mg/L)	ORP (mV)
Gonzalez Dairy						
177-01	13-Feb-2020	7.43	6,345	19.5	1.81	121
	19-Nov-2019	6.68	6,420	19.7	1.25	140
	7-Aug-2019	7.00	6,771	20.4	NM	212
	20-May-2019	6.38	6,638	19.1	2.36	154
	27-Feb-2019	7.09	6,752	19.7	2.52	154
	15-Nov-2018	7.02	6,711	20.9	2.29	168
	21-Aug-2018	7.28	6,633	21.7	2.11	158
	22-May-2018	6.83	6,675	19.4	1.87	124
	14-Feb-2018	7.33	6,700	20.7	2.19	146
	10-Nov-2017	6.88	6,663	21.1	1.23	108
	14-Aug-2017	7.21	6,694	21.3	4.55	91
	22-May-2017	6.73	5,875	19.44	1.96	180.2
	22-Feb-2017	7.26	6,219	20.08	3.20	127.7
	10-Nov-2016	7.40	6,333	20.48	1.88	137.7
	23-Aug-2016	7.08	6,380	20.41	0.91	34.7
	20-May-2016	7.15	5,537	19.13	2.48	69.6
	11-Feb-2016	7.33	5,715	19.50	2.90	264.0
11-Nov-2015	7.32	5,790	20.81	1.56	188.9	
21-Aug-2015	7.05	6,118	20.90	NM	242.7	
177-02	13-Feb-2020	7.87	3,271	19.7	2.20	100
	19-Nov-2019	7.05	3,204	19.8	0.79	104
	7-Aug-2019	7.55	2,142	20.7	NM	212
	20-May-2019	6.90	2,317	18.3	1.89	103
	27-Feb-2019	7.63	2,151	19.6	2.22	125
	15-Nov-2018	7.22	2,221	21.2	1.93	144
	21-Aug-2018	7.56	2,966	22.6	2.29	150
	22-May-2018	7.29	2,271	21.8	2.66	115
	14-Feb-2018	7.58	2,460	20.6	3.14	146
	10-Nov-2017	7.49	2,502	21.6	5.05	80
	14-Aug-2017	7.34	4,958	22.3	5.82	135
	22-May-2017	6.94	4,402	19.77	3.23	153.1
	22-Feb-2017	7.35	4,425	20.32	6.18	220.9
	10-Nov-2016	7.50	4,378	21.41	2.38	122.6
	23-Aug-2016	7.16	4,406	21.91	3.99	33.8
	20-May-2016	7.21	3,605	19.22	6.30	86.5
	11-Feb-2016	7.40	4,032	19.78	5.57	227.6
11-Nov-2015	7.36	3,964	21.15	3.82	109.3	
21-Aug-2015	7.11	4,229	21.80	NM	254.6	
177-03A	13-Feb-2020	7.34	3,645	21.7	2.45	109
	19-Nov-2019	6.40	3,577	21.7	0.76	178
	13-Aug-2019	7.00	4,324	22.3	1.80	192
	20-May-2019	6.45	3,895	21.6	1.45	114
	27-Feb-2019	6.86	3,989	21.9	2.13	153
	20-Nov-2018	6.91	4,114	22.5	2.75	130
	21-Aug-2018	7.60	2,728	26.0	1.64	186
	22-May-2018	6.66	3,879	23.6	1.74	105
	15-Feb-2018	7.17	2,854	23.5	1.91	148
	10-Nov-2017	7.07	2,853	21.3	3.35	91
	15-Aug-2017	7.32	3,534	22.7	4.16	106
	22-May-2017	6.86	3,511	21.94	2.90	151.3
	23-Feb-2017	7.27	3,927	21.19	5.41	172.5
	11-Nov-2016	7.39	3,899	21.50	4.63	125.1
	24-Aug-2016	6.95	5,686	21.47	1.31	26.0
	20-May-2016	7.21	3,127	21.65	3.55	74.0
	11-Feb-2016	7.14	6,048	21.69	3.47	277.7
11-Nov-2015	7.27	3,964	20.69	1.89	218.1	
21-Aug-2015	7.08	3,100	22.50	NM	227.6	

**TABLE 2. SUMMARY OF MONITORING WELL GROUNDWATER FIELD PARAMETERS
DONA ANA DAIRIES, DONA ANA COUNTY, NEW MEXICO**

Monitoring Well	Date Measured	pH	SpC (uS/cm)	Temp (°C)	DO (mg/L)	ORP (mV)
177-04	13-Feb-2020	7.62	4,610	21.3	1.52	122
	19-Nov-2019	6.74	4,632	21.4	2.86	180
	13-Aug-2019	7.01	4,987	22.0	1.50	159
	20-May-2019	6.61	4,952	21.6	4.11	232
	27-Feb-2019	6.98	5,164	22.2	2.61	154
	20-Nov-2018	6.99	5,291	19.9	2.09	130
	21-Aug-2018	7.58	5,135	23.8	1.88	166
	22-May-2018	7.01	5,439	23.0	1.48	127
	15-Feb-2018	7.35	5,528	21.3	1.65	150
	10-Nov-2017	7.10	5,622	21.2	2.19	69
	16-Aug-2017	7.11	5,919	21.6	4.68	162
	22-May-2017	6.69	5,762	21.69	2.82	162.5
	23-Feb-2017	7.24	5,668	20.82	2.29	183.4
	10-Nov-2016	7.40	6,333	20.48	1.88	137.7
	24-Aug-2016	7.02	6,238	21.68	1.02	31.1
	23-May-2016	7.21	5,536	21.48	4.08	62.3
	11-Feb-2016	7.13	6,020	21.01	3.80	210.9
	11-Nov-2015	7.39	5,889	26.93	1.61	227.1
	21-Aug-2015	6.96	6,091	21.70	NM	226.8
177-05	13-Feb-2020	7.35	5,688	20.9	1.73	131
	19-Nov-2019	6.71	5,904	22.2	6.32	246
	13-Aug-2019	7.01	6,519	22.3	1.12	67
	20-May-2019	6.76	6,249	22.0	4.25	247
	27-Feb-2019	7.07	6,088	21.6	2.09	164
	20-Nov-2018	6.96	6,217	21.4	2.50	133
	21-Aug-2018	7.51	6,361	24.2	2.17	157
	22-May-2018	7.01	6,496	22.0	1.88	116
	15-Feb-2018	7.23	6,687	21.5	3.17	139
	10-Nov-2017	6.89	6,601	21.5	3.01	110
	15-Aug-2017	7.12	6,859	21.9	5.42	143
	22-May-2017	6.70	6,302	21.06	2.27	161.5
	23-Feb-2017	7.44	5,640	21.14	4.19	208.8
	11-Nov-2016	7.24	5,833	21.20	3.99	109.0
	24-Aug-2016	7.02	5,759	20.89	2.90	35.1
	20-May-2016	7.09	5,411	20.88	3.46	98.7
	11-Feb-2016	7.27	4,910	20.54	3.48	202.9
	11-Nov-2015	7.45	5,241	18.92	3.84	151.4
	21-Aug-2015	7.17	5,662	21.50	NM	219.1
177-06	13-Feb-2020	Dry Since February 2020				
	19-Nov-2019	Dry				
	13-Aug-2019	Dry				
	20-May-2019	Dry				
	27-Feb-2019	Dry				
	20-Nov-2018	Dry				
	21-Aug-2018	Dry				
	22-May-2018	Dry				
	15-Feb-2018	Dry				
	10-Nov-2017	Dry				
	14-Aug-2017	Dry				
	22-May-2017	Dry				
	23-Feb-2017	Dry				
	11-Nov-2016	Dry				
	24-Aug-2016	Dry				
23-May-2016	Dry					
11-Feb-2016	Dry					
11-Nov-2015	Dry					
21-Aug-2015	Dry					

**TABLE 2. SUMMARY OF MONITORING WELL GROUNDWATER FIELD PARAMETERS
DONA ANA DAIRIES, DONA ANA COUNTY, NEW MEXICO**

Monitoring Well	Date Measured	pH	SpC (uS/cm)	Temp (°C)	DO (mg/L)	ORP (mV)
177-07R	13-Feb-2020	7.58	4,327	21.0	1.22	107
	19-Nov-2019	6.73	4,360	21.4	1.47	193
	7-Aug-2019	7.11	4,709	22.8	NM	234
	20-May-2019	6.66	4,663	22.0	3.19	314
	27-Feb-2019	7.24	4,760	21.6	1.66	150
	20-Nov-2018	7.03	4,938	20.5	1.86	128
	21-Aug-2018	7.39	5,116	23.2	1.34	152
	22-May-2018	6.64	5,311	21.7	1.54	125
	14-Feb-2018	7.19	5,452	22.3	1.86	153
	10-Nov-2017	6.87	5,582	21.6	2.94	125
	14-Aug-2017	7.33	5,720	22.5	4.20	180
	22-May-2017	6.95	5,436	21.25	3.76	153.4
	23-Feb-2017	7.59	5,310	20.16	5.08	209.2
	11-Nov-2016	7.58	5,319	20.93	6.56	157.2
	23-Aug-2016	7.24	5,416	21.69	2.41	33.9
	23-May-2016	7.21	5,036	21.90	2.41	62.8
	11-Feb-2016	7.34	5,032	20.87	3.30	236.8
	11-Nov-2015	7.32	5,017	20.61	3.47	201.4
21-Aug-2015	7.07	5,710	23.11	NM	250.2	
CENTRAL AREA						
Buena Vista Dairy II						
74-01	15-May-2023	7.24	4,671	22.7	1.73	133
	17-Feb-2023	7.38	4,630	20.8	2.02	141
	15-Nov-2022	7.26	4,687	20.0	2.86	164
	16-Aug-2022	7.24	4,661	22.7	2.66	154
	13-May-2022	7.43	4,548	22.7	2.80	156
	22-Feb-2022	7.60	4,515	23.5	2.84	132
	12-Nov-2021	7.20	4,776	22.4	2.04	62
	19-Aug-2021	7.39	5,141	26.2	2.38	103
	17-May-2021	7.29	5,475	23.1	2.90	-181
	22-Feb-2021	7.52	6,000	22.1	2.69	-214
	17-Nov-2020	7.29	9,629	22.3	1.15	98
	21-Aug-2020	7.28	4,543	23.2	1.43	206
	18-May-2020	7.34	5,599	23.8	2.35	114
	14-Feb-2020	7.85	5,729	19.8	2.13	127
	19-Nov-2019	6.71	6,110	22.9	5.08	192
	14-Aug-2019	7.34	4,632	22.4	1.10	171
	21-May-2019	6.60	4,802	22.0	2.08	304
	28-Feb-2019	7.36	4,943	22.2	1.34	162
	16-Nov-2018	7.15	6,129	21.4	1.11	172
	29-Aug-2018	7.21	5,860	22.3	1.49	197
	23-May-2018	6.97	4,912	22.9	1.66	138
	19-Feb-2018	7.59	5,408	21.4	2.10	154
	14-Nov-2017	7.05	5,148	21.9	2.31	135
	16-Aug-2017	7.46	5,622	22.6	2.91	182
	26-May-2017	6.76	4,253	21.77	2.40	144.9
	24-Feb-2017	7.46	4,517	20.58	1.94	187.8
	14-Nov-2016	7.48	5,369	21.87	1.43	141.5
	24-Aug-2016	7.22	5,633	21.78	1.92	30.9
	25-May-2016	7.20	4,355	21.89	2.02	106.5
	18-Feb-2016	7.28	4,147	21.21	1.64	365.1
12-Nov-2015	7.26	3,836	20.15	1.06	210.6	
24-Aug-2015	7.37	4,959	22.17	NM	243.2	

**TABLE 2. SUMMARY OF MONITORING WELL GROUNDWATER FIELD PARAMETERS
DONA ANA DAIRIES, DONA ANA COUNTY, NEW MEXICO**

Monitoring Well	Date Measured	pH	SpC (uS/cm)	Temp (°C)	DO (mg/L)	ORP (mV)
74-02	12-May-2023	7.27	3,911	23.7	2.92	84
	17-Feb-2023	7.35	3,886	20.2	2.90	145
	14-Nov-2022	7.29	3,874	21.20	2.37	-35.0
	15-Aug-2022	7.24	3,905	23.9	2.87	3
	13-May-2022	7.38	3,766	21.5	2.92	132
	22-Feb-2022	7.22	3,814	20.1	2.95	125
	11-Nov-2021	7.56	3,871	22.1	2.95	-116
	19-Aug-2021	7.68	4,036	24.4	2.08	-16
	14-May-2021	7.33	5,162	23.0	2.70	148
	22-Feb-2021	7.22	8,153	20.7	2.18	-253
	17-Nov-2020	7.20	1,364	22.8	0.96	175
	21-Aug-2020	7.48	3,876	23.2	2.09	255
	15-May-2020	7.43	3,795	24.0	NM	137
	14-Feb-2020	7.43	3,780	20.0	3.14	126
	19-Nov-2019	6.82	4,182	22.5	8.73	223
	14-Aug-2019	7.10	3,666	22.2	1.36	271
	21-May-2019	6.90	3,723	20.2	2.19	313
	28-Feb-2019	7.36	3,730	20.9	1.81	158
	15-Nov-2018	7.19	3,611	22.5	2.13	167
	23-Aug-2018	7.80	3,478	22.9	1.98	118
	23-May-2018	6.97	3,709	21.2	3.17	129
	15-Feb-2018	7.66	3,569	20.6	3.62	136
	14-Nov-2017	6.97	3,517	22.4	2.27	132
	15-Aug-2017	7.32	3,427	22.3	5.21	122
	25-May-2017	6.85	3,630	21.72	3.06	133.3
	24-Feb-2017	7.43	3,688	20.88	6.47	216.4
	14-Nov-2016	7.54	3,788	22.07	3.76	92.6
	24-Aug-2016	7.10	3,884	21.90	1.83	30.9
	25-May-2016	7.20	3,408	20.47	2.39	92.2
	18-Feb-2016	7.60	3,995	21.01	3.82	398.5
11-Nov-2015	7.32	3,315	21.76	0.90	194.9	
24-Aug-2015	7.22	3,377	21.48	NM	252.2	
74-03	12-May-2023	7.32	2,493	22.0	1.88	91
	17-Feb-2023	7.30	2,660	20.2	2.10	163
	14-Nov-2022	7.42	2,296	22.40	1.76	167.0
	15-Aug-2022	7.22	2,087	24.8	1.56	274
	13-May-2022	7.33	2,064	21.2	1.53	196
	22-Feb-2022	7.20	2,187	21.3	1.59	174
	11-Nov-2021	7.84	2,271	23.0	1.69	109
	13-Aug-2021	7.70	2,265	23.9	1.67	97
	14-May-2021	7.80	2,299	22.4	1.77	81
	22-Feb-2021	7.90	2,323	21.3	1.76	149
	19-Aug-2020	7.72	2,451	26.4	1.77	91
	15-May-2020	7.51	2,429	23.9	1.77	139
	14-Feb-2020	7.71	2,221	19.3	3.89	138
	19-Nov-2019	7.02	2,260	23.5	10.10	232
	14-Aug-2019	7.45	2,331	22.4	1.18	192
	21-May-2019	7.08	2,335	20.4	2.50	288
	28-Feb-2019	7.54	2,309	21.4	2.31	148
	15-Nov-2018	7.40	2,636	23.2	2.66	150
	23-Aug-2018	7.35	2,883	23.4	3.11	129
	23-May-2018	7.61	3,186	21.4	3.84	136
	15-Feb-2018	7.61	3,316	20.9	4.13	141
	14-Nov-2017	7.48	3,464	23.5	3.76	139
	15-Aug-2017	7.54	3,447	23.5	3.91	148
	25-May-2017	6.84	3,826	21.27	1.92	142.5
	24-Feb-2017	7.59	3,770	20.67	4.64	134.8
	14-Nov-2016	7.60	3,886	23.01	2.64	96.4
	24-Aug-2016	7.19	4,189	22.91	1.02	27.2
	25-May-2016	7.21	3,828	20.39	3.47	100.9
	18-Feb-2016	7.38	4,067	20.10	2.79	597.0
	12-Nov-2015	7.36	4,868	20.28	1.11	233.4
24-Aug-2015	7.24	5,541	22.39	NM	263.7	

**TABLE 2. SUMMARY OF MONITORING WELL GROUNDWATER FIELD PARAMETERS
DONA ANA DAIRIES, DONA ANA COUNTY, NEW MEXICO**

Monitoring Well	Date Measured	pH	SpC (uS/cm)	Temp (°C)	DO (mg/L)	ORP (mV)
74-04	15-May-2023	7.33	2,915	22.0	2.13	79
	21-Feb-2023	7.23	3,570	21.8	2.77	154
	14-Nov-2022	7.25	3,581	20.90	2.74	276.0
	16-Aug-2022	7.30	3,365	23.4	2.31	240
	16-May-2022	7.18	3,433	21.9	2.29	221
	23-Feb-2022	7.28	3,637	20.4	2.88	186
	12-Nov-2021	7.68	3,587	22.9	2.77	109
	19-Aug-2021	7.42	4,083	23.3	2.36	99
	17-May-2021	7.82	3,530	23.2	2.68	-175
	22-Feb-2021	7.84	3,387	21.8	2.66	-16
	17-Nov-2020	7.33	4,207	23.2	2.36	8
	21-Aug-2020	7.48	3,513	23.1	2.61	160
	18-May-2020	7.32	3,202	23.3	2.32	96
	14-Feb-2020	7.46	3,235	21.6	2.12	118
	20-Nov-2019	6.84	3,375	21.2	6.28	207
	14-Aug-2019	7.01	3,600	22.8	1.30	163
	21-May-2019	6.61	2,882	21.3	2.30	276
	1-Mar-2019	6.84	3,426	20.7	1.51	166
	16-Nov-2018	7.02	3,437	21.8	1.55	146
	31-Aug-2018	7.11	3,329	22.5	1.83	265
	23-May-2018	6.84	3,068	22.8	2.27	125
	19-Feb-2018	7.53	3,139	20.4	2.05	129
	14-Nov-2017	7.37	3,128	22.1	3.54	142
	16-Aug-2017	7.32	3,229	23.5	4.24	130
	26-May-2017	6.96	2,980	22.2	2.76	144.7
	24-Feb-2017	7.46	2,973	19.48	2.60	224.5
	15-Nov-2016	7.62	3,099	21.20	3.28	85.0
	24-Aug-2016	6.82	3,243	21.16	2.50	103.4
	25-May-2016	7.09	3,131	22.67	2.22	114.3
	18-Feb-2016	7.35	2,978	21.11	2.85	328.1
12-Nov-2015	7.32	2,868	17.58	3.06	197.2	
24-Aug-2015	7.41	3,134	22.42	NM	182.8	
74-05	15-May-2023	7.27	3,550	23.3	2.68	307
	21-Feb-2023	7.28	3,537	21.8	2.71	177
	15-Nov-2022	7.24	3,531	22.50	2.70	316.0
	16-Aug-2022	7.27	3,499	24.4	2.65	277
	16-May-2022	7.58	3,491	23.9	2.64	249
	23-Feb-2022	7.66	3,458	22.4	2.62	164
	15-Nov-2021	7.20	3,464	23.1	2.64	185
	31-Aug-2021	7.65	3,522	25.3	2.61	161
	17-May-2021	7.79	3,582	24.6	2.68	18
	23-Feb-2021	7.83	3,496	22.6	2.66	-4
	17-Nov-2020	7.65	4,343	22.5	2.78	-25
	21-Aug-2020	7.70	3,493	22.9	2.57	135
	18-May-2020	7.33	3,440	23.1	2.54	188
	14-Feb-2020	7.20	3,231	21.5	4.91	81
	20-Nov-2019	6.80	3,216	21.4	6.01	67
	13-Aug-2019	7.03	3,353	22.7	0.71	-16
	21-May-2019	6.46	3,256	21.2	2.24	272
	1-Mar-2019	6.97	3,331	21.5	1.79	154
	16-Nov-2018	7.06	3,373	22.0	2.28	144
	29-Aug-2018	6.96	3,353	22.8	2.91	184
	23-May-2018	6.83	3,380	22.2	2.54	129
	19-Feb-2018	7.25	3,337	21.3	1.46	137
	14-Nov-2017	7.09	3,151	21.9	0.94	111
	16-Aug-2017	7.34	3,211	22.6	3.36	146
	26-May-2017	7.02	3,214	22.09	3.70	154.2
	24-Feb-2017	7.39	3,122	19.58	3.26	155.2
	15-Nov-2016	7.30	3,141	21.77	1.07	97.4
	25-Aug-2016	6.82	3,197	21.52	1.76	48.2
	25-May-2016	7.12	2,946	22.09	2.01	97.3
	18-Feb-2016	7.18	2,933	20.38	2.33	302.7
12-Nov-2015	7.20	2,923	20.12	1.23	214.2	
24-Aug-2015	7.11	3,179	24.11	NM	240.7	

**TABLE 2. SUMMARY OF MONITORING WELL GROUNDWATER FIELD PARAMETERS
DONA ANA DAIRIES, DONA ANA COUNTY, NEW MEXICO**

Monitoring Well	Date Measured	pH	SpC (uS/cm)	Temp (°C)	DO (mg/L)	ORP (mV)	
River Valley Dairy							
167-01A	15-Nov-2017	7.71	2,966	20.20	2.16	48.0	
	16-Aug-2017	7.47	3,611	20.70	4.62	195.0	
	23-May-2017	6.80	3,601	19.30	1.84	111.9	
	27-Feb-2017	7.37	3,610	19.07	5.06	154.2	
	15-Nov-2016	7.89	3,725	20.38	2.78	85.7	
	30-Aug-2016	7.35	3,621	20.60	2.61	59.1	
	24-May-2016	7.36	3,576	18.60	3.24	43.4	
	17-Feb-2016	6.92	3,973	18.55	1.96	79.6	
	16-Nov-2015	7.34	4,001	19.50	1.41	221.2	
	24-Aug-2015	7.47	4,361	27.51	NM	77.5	
167-02	15-Nov-2017	7.20	3,960	20.30	3.40	79.0	
	16-Aug-2017	7.11	3,807	20.50	3.96	191.0	
	23-May-2017	6.76	3,244	20.77	2.10	135.8	
	27-Feb-2017	7.15	3,244	19.39	7.10	219.2	
	15-Nov-2016	7.59	2,934	20.29	3.92	99.6	
	30-Aug-2016	7.39	2,497	21.40	2.71	72.2	
	24-May-2016	7.17	2,452	20.20	4.11	56.6	
	17-Feb-2016	6.92	2,312	20.00	6.49	155.5	
	16-Nov-2015	Dry					
	24-Aug-2015	Insufficient Water-Parameters Not Collected					
167-03	15-Nov-2017	7.34	2,960	21.80	1.90	81.0	
	17-Aug-2017	7.33	2,947	22.50	3.31	155.0	
	25-May-2017	6.96	2,851	22.55	2.56	172.5	
	27-Feb-2017	7.26	2,839	21.87	3.18	218.6	
	15-Nov-2016	7.77	2,911	22.56	1.07	-108.6	
	31-Aug-2016	7.44	2,964	23.20	1.96	36.7	
	25-May-2016	7.06	2,836	21.69	2.41	117.5	
	17-Feb-2016	6.93	2,803	21.72	2.94	196.6	
	16-Nov-2015	7.34	2,998	21.43	1.46	246.1	
	25-Aug-2015	7.29	3,054	21.90	NM	198.2	
167-04	15-Nov-2017	7.52	5,469	21.30	2.64	42.0	
	17-Aug-2017	7.53	5,446	21.50	6.11	52.0	
	25-May-2017	7.05	5,234	21.16	2.13	180.0	
	27-Feb-2017	7.42	5,216	20.62	3.46	203.8	
	15-Nov-2016	7.72	5,388	20.93	3.48	83.8	
	30-Aug-2016	7.31	5,342	21.80	4.21	34.1	
	24-May-2016	7.43	5,088	21.54	1.76	39.8	
	17-Feb-2016	6.74	4,856	20.05	3.37	209.0	
	16-Nov-2015	7.50	4,234	20.07	NM	223.0	
	25-Aug-2015	7.35	4,944	21.43	NM	171.1	
167-05	15-Nov-2017	7.00	4,945	20.80	2.45	163.0	
	17-Aug-2017	7.21	4,818	20.20	4.84	198.0	
	25-May-2017	6.47	4,277	19.64	2.47	148.5	
	28-Feb-2017	7.29	4,459	19.03	1.78	216.8	
	16-Nov-2016	7.65	4,456	19.72	3.17	67.8	
	30-Aug-2016	7.17	4,229	21.50	2.19	70.9	
	26-May-2016	7.27	3,995	18.67	3.11	57.4	
	17-Feb-2016	6.80	4,183	20.42	2.16	147.7	
	13-Nov-2015	7.25	4,146	19.81	1.11	142.6	
	25-Aug-2015	7.20	4,308	20.69	NM	223.5	
167-06	15-Nov-2017	7.31	3,611	21.80	2.76	160	
	17-Aug-2017	7.25	3,591	22.00	4.88	18.0	
	25-May-2017	6.91	3,600	22.49	2.12	136.6	
	27-Feb-2017	7.16	3,590	21.93	2.51	188.3	
	15-Nov-2016	7.68	3,588	21.80	1.86	76.7	
	30-Aug-2016	7.17	3,557	22.70	2.76	57.3	
	24-May-2016	7.22	3,450	21.69	2.71	35.7	
	17-Feb-2016	6.45	3,497	21.21	2.01	276.0	
	13-Nov-2015	7.26	3,612	20.60	1.02	171.1	
24-Aug-2015	7.13	3,782	22.71	NM	252.5		

**TABLE 2. SUMMARY OF MONITORING WELL GROUNDWATER FIELD PARAMETERS
DONA ANA DAIRIES, DONA ANA COUNTY, NEW MEXICO**

Monitoring Well	Date Measured	pH	SpC (uS/cm)	Temp (°C)	DO (mg/L)	ORP (mV)
167-07	15-Nov-2017	8.02	1,733	20.40	1.86	62.0
	17-Aug-2017	7.62	1,866	20.10	5.34	46.0
	23-May-2017	7.98	1,685	19.46	2.40	138.3
	27-Feb-2017	7.68	1,460	19.29	1.59	197.6
	15-Nov-2016	8.12	1,415	20.13	1.78	20.2
	30-Aug-2016	7.54	1,771	20.70	1.70	16.2
	24-May-2016	7.65	1,330	19.47	0.75	-17.1
	17-Feb-2016	6.91	1,648	19.77	1.31	-76.3
	13-Nov-2015	7.64	1,825	18.72	1.12	-114.1
	24-Aug-2015	7.29	4,621	20.89	NM	72.4
167-08	15-Nov-2017	7.19	5,859	18.90	2.52	62.0
	17-Aug-2017	7.17	5,651	20.40	4.11	149.0
	25-May-2017	6.89	5,064	19.19	2.83	152.8
	28-Feb-2017	7.22	5,174	18.33	1.08	198.6
	16-Nov-2016	7.90	5,083	18.99	1.67	82.8
	31-Aug-2016	7.06	4,725	19.80	2.17	54.1
	25-May-2016	7.14	3,874	18.39	1.76	92.8
	17-Feb-2016	6.90	4,601	20.11	2.26	75.6
	23-Nov-2015	7.38	3,463	17.09	1.27	32.8
	25-Aug-2015	Bailer Stuck in Well-Parameters Not Collected				
167-09	15-Nov-2017	7.00	4,927	20.00	3.33	146.0
	17-Aug-2017	7.16	4,573	20.00	4.22	102.0
	25-May-2017	6.70	3,718	19.06	2.56	137.2
	27-Feb-2017	7.18	3,604	18.71	4.08	225.4
	15-Nov-2016	7.63	3,662	19.61	2.21	179.6
	30-Aug-2016	7.14	3,500	20.60	1.67	64.3
	24-May-2016	7.27	3,366	18.23	2.54	40.3
	17-Feb-2016	7.00	3,328	17.96	1.78	109.9
	13-Nov-2015	7.25	3,381	18.69	1.06	0.5
	25-Aug-2015	7.21	3,352	19.37	NM	226.5

**TABLE 2. SUMMARY OF MONITORING WELL GROUNDWATER FIELD PARAMETERS
DONA ANA DAIRIES, DONA ANA COUNTY, NEW MEXICO**

Monitoring Well	Date Measured	pH	SpC (uS/cm)	Temp (°C)	DO (mg/L)	ORP (mV)
Big Sky Dairy						
833-01	5-Aug-2017	Plugged and Abandoned				
	31-May-2017	Dry				
	1-Mar-2017	Dry				
	17-Nov-2016	Dry				
	29-Aug-2016	Dry				
	27-May-2016	Dry				
	22-Feb-2016	Dry				
	18-Nov-2015	Dry				
	27-Aug-2015	Dry				
833-02	16-May-2023	7.22	5,959	20.7	1.74	211
	22-Feb-2023	7.24	5,841	18.2	2.66	186
	17-Nov-2022	7.24	5,531	19	2.59	197
	17-Aug-2022	7.27	4,715	20.2	2.66	152
	18-May-2022	7.24	6,273	19.5	2.08	186
	24-Feb-2022	7.67	5,532	16.8	2.59	201
	16-Nov-2021	7.19	6,064	19.5	2.83	205
	17-Aug-2021	7.73	5,666	20.6	2.88	97
	18-May-2021	7.77	6,551	20.5	2.15	136
	24-Feb-2021	7.73	5,908	18.9	2.59	110
	18-Nov-2020	7.64	5,770	19.6	1.11	108
	24-Aug-2020	7.72	5,044	22.2	2.11	167
	20-May-2020	7.43	4,981	21.2	2.75	244
	17-Feb-2020	7.97	5,542	20.1	2.37	95
	21-Nov-2019	7.72	4,903	19.6	3.14	212
	14-Aug-2019	7.23	6,553	22.2	1.82	117
	22-May-2019	6.98	6,354	20.9	1.88	281
	4-Mar-2019	7.11	4,796	18.7	2.11	154
	26-Nov-2018	7.23	6,466	19.8	2.36	143
	31-Aug-2018	7.34	6,321	20.4	2.61	178
	29-May-2018	6.98	6,471	19.7	2.11	144
	21-Feb-2018	7.66	6,511	20.9	3.36	164
	16-Nov-2017	7.30	6,625	20.4	3.63	155
	1-Sep-2017	7.71	5,105	19.5	4.67	190
	30-May-2017	7.09	6,119	19.8	2.53	178.4
	28-Feb-2017	7.24	6,231	20.29	2.08	178.6
	18-Nov-2016	7.48	6,309	20.07	4.65	62.0
29-Aug-2016	7.12	6,158	23.70	2.06	73.6	
31-May-2016	7.37	6,169	20.14	5.43	39.3	
22-Feb-2016	7.18	3,622	19.53	3.76	232.3	
18-Nov-2015	7.58	5,996	19.69	2.45	210.1	
27-Aug-2015	8.17	3,718	24.36	NM	176.1	
833-03	5-Aug-2017	Plugged and Abandoned				
	1-Sep-2017	Dry				
	30-May-2017	Dry				
	1-Mar-2017	Dry				
	17-Nov-2016	Dry				
	29-Aug-2016	Dry				
	27-May-2016	Dry				
	18-Feb-2016	Dry				
	18-Nov-2015	Dry				
	27-Aug-2015	Dry				

**TABLE 2. SUMMARY OF MONITORING WELL GROUNDWATER FIELD PARAMETERS
DONA ANA DAIRIES, DONA ANA COUNTY, NEW MEXICO**

Monitoring Well	Date Measured	pH	SpC (uS/cm)	Temp (°C)	DO (mg/L)	ORP (mV)
833-04	16-May-2023	7.23	4,283	21.5	2.33	164
	21-Feb-2023	7.30	4,697	20.9	2.05	225
	17-Nov-2022	7.21	4,400	20.5	1.86	199
	17-Aug-2022	7.21	3,889	21.6	2.72	164
	16-May-2022	7.52	4,587	23.0	2.68	164
	24-Feb-2022	7.20	4,236	18.2	2.46	203
	15-Nov-2021	7.69	4,420	22.1	2.91	116
	17-Aug-2021	7.31	4,365	22.2	2.39	115
	17-May-2021	7.64	3,505	21.6	2.45	137
	23-Feb-2021	7.78	3,720	21.3	2.62	82
	18-Nov-2020	7.44	3,882	19.9	2.47	112
	24-Aug-2020	7.45	3,577	22.7	2.60	140
	20-May-2020	7.75	3,571	22.3	2.92	225
	17-Feb-2020	7.71	3,778	20.8	2.30	89
	20-Nov-2019	7.00	4,257	21.0	10.93	278
	15-Aug-2019	7.04	5,007	21.3	0.97	114
	23-May-2019	6.44	4,367	21.3	1.64	292
	4-Mar-2019	7.31	3,873	20.7	1.34	137
	26-Nov-2018	7.40	5,024	20.7	1.74	134
	4-Sep-2018	7.22	4,860	21.5	1.75	104
	24-May-2018	7.05	4,739	21.1	1.96	112
	20-Feb-2018	7.71	3,795	20.5	3.84	152
	20-Nov-2017	7.41	4,752	20.6	3.08	125
	8-Sep-2017	7.30	4,281	22.0	4.18	158
	31-Aug-2017	7.27	4,487	20.8	2.40	209
	30-May-2017	7.09	4,351	20.84	3.24	236.1
	1-Mar-2017	7.46	4,517	20.52	1.41	244.1
	17-Nov-2016	7.33	4,861	21.10	5.71	137.9
	29-Aug-2016	7.20	4,658	23.70	1.21	50.5
	27-May-2016	7.38	3,299	20.54	4.18	60.3
22-Feb-2016	7.27	3,279	19.95	3.49	256.5	
19-Nov-2015	7.69	3,169	19.07	4.15	218.6	
27-Aug-2015	7.52	3,656	22.15	NM	190.9	
833-05	3-Jul-2023	7.22	4,618	23.1	1.35	152
	23-Feb-2023	7.20	5,371	21.9	1.25	190
	21-Nov-2022	7.27	5,083	22.3	2.7	208
	18-Aug-2022	7.27	5,466	24.5	2.48	183
	18-May-2022	7.44	5,415	24.0	2.84	188
	10-Mar-2022	7.30	5,440	22.0	2.73	189
	16-Nov-2021	7.49	5,523	23.2	2.30	188
	17-Aug-2021	7.64	5,289	24.6	2.41	91
	19-May-2021	7.51	5,335	23.0	2.64	98
	25-Feb-2021	7.50	5,363	22.2	2.84	148
	19-Nov-2020	7.27	5,270	24.1	2.08	128
	25-Aug-2020	7.57	5,548	24.0	1.35	198
	19-May-2020	7.13	5,225	23.5	1.89	148
	17-Feb-2020	7.23	5,277	22.5	1.65	171
	20-Nov-2019	6.56	5,309	23.0	6.96	259
	15-Aug-2019	6.75	5,580	23.4	1.58	125
	22-May-2019	6.52	5,324	23.4	2.31	290
	5-Mar-2019	6.54	3,394	22.2	NM	159
	26-Nov-2018	6.85	5,411	22.8	1.88	128
	31-Aug-2018	6.79	5,389	23.6	2.68	144
	24-May-2018	6.54	5,271	23.0	2.34	138
	22-Feb-2018	7.39	5,475	22.1	2.81	155
	17-Nov-2017	6.73	5,481	22.1	3.01	97
	31-Aug-2017	6.70	5,659	22.9	2.56	220
	31-May-2017	6.92	5,273	22.69	2.94	199.6
	1-Mar-2017	7.30	5,302	21.26	1.64	249.9
	17-Nov-2016	7.03	5,663	23.59	3.85	128.7
	29-Aug-2016	6.78	5,179	25.10	1.34	4.86
	26-May-2016	6.96	4,643	23.52	3.41	58.9
	19-Feb-2016	7.41	4,745	22.59	3.27	208.8
18-Nov-2015	6.98	4,260	23.40	3.44	190.2	
27-Aug-2015	6.93	3,979	23.52	NM	232.1	

**TABLE 2. SUMMARY OF MONITORING WELL GROUNDWATER FIELD PARAMETERS
DONA ANA DAIRIES, DONA ANA COUNTY, NEW MEXICO**

Monitoring Well	Date Measured	pH	SpC (uS/cm)	Temp (°C)	DO (mg/L)	ORP (mV)
833-06	15-May-2023	7.30	4,261	21.4	2.90	103
	21-Feb-2023	7.34	4,231	20.3	2.61	256
	17-Nov-2022	7.28	4,198	19.9	2.38	196
	17-Aug-2022	7.21	4,522	20.9	1.39	167
	16-May-2022	7.36	4,350	23.0	2.94	232
	23-Feb-2022	7.62	4,013	21.2	2.91	118
	15-Nov-2021	7.55	4,410	21.8	2.90	118
	17-Aug-2021	7.19	4,234	21.0	2.07	137
	18-May-2021	7.83	4,348	20.3	2.38	118
	23-Feb-2021	7.63	4,029	20.6	1.23	39
	18-Nov-2020	7.55	4,241	21.2	2.30	140
	24-Aug-2020	7.46	4,603	22.9	1.38	190
	19-May-2020	7.49	4,365	21.9	2.90	247
	17-Feb-2020	7.30	4,057	20.3	2.76	93
	20-Nov-2019	7.90	4,032	20.5	1.62	257
	15-Aug-2019	6.97	4,289	22.0	3.45	120
	23-May-2019	6.29	4,151	21.2	1.59	297
	5-Mar-2019	7.17	2,935	20.3	NM	142
	27-Nov-2018	6.86	4,141	20.0	2.39	164
	4-Sep-2018	7.08	3,542	22.0	1.24	137
	29-May-2018	6.81	3,582	22.2	2.59	102
	22-Feb-2018	7.11	3,935	20.8	3.51	164
	16-Nov-2017	6.82	4,046	22.0	4.39	147
	1-Sep-2017	6.85	4,170	21.0	3.54	160
	31-May-2017	6.84	3,880	21.9	2.31	152.3
	1-Mar-2017	7.38	4,105	21.31	1.36	242.1
	17-Nov-2016	7.29	4,150	21.72	6.35	142.4
	26-Aug-2016	6.65	3,851	21.95	1.87	36.3
	27-May-2016	7.07	3,388	20.75	5.74	66.4
	22-Feb-2016	7.75	3,246	20.21	5.36	263.2
19-Nov-2015	7.32	3,564	19.59	5.36	221.7	
27-Aug-2015	7.26	3,677	23.01	NM	199.7	
833-07	16-May-2023	7.20	6,590	22.5	2.64	133
	22-Feb-2023	7.25	5,794	19.4	2.26	219
	18-Nov-2022	7.23	5,932	20.8	1.77	209
	18-Aug-2022	7.20	6,409	22.7	2.55	171
	18-May-2022	7.51	6,171	22.5	2.90	179
	10-Mar-2022	7.38	5,522	21.5	2.44	156
	16-Nov-2021	7.58	5,817	22.1	2.47	182
	18-Aug-2021	7.66	5,538	22.4	2.14	100
	18-May-2021	7.49	5,500	22.8	2.92	169
	24-Feb-2021	7.72	5,320	21.5	2.24	87
	19-Nov-2020	7.15	5,379	22.2	2.94	215
	25-Aug-2020	7.26	5,661	23.5	2.00	185
	19-May-2020	7.38	5,758	22.7	2.78	180
	17-Feb-2020	7.27	5,366	21.5	2.23	124
	20-Nov-2019	6.78	5,340	21.2	7.61	254
	15-Aug-2019	6.91	5,534	22.1	1.23	105
	22-May-2019	6.71	5,492	22.3	1.75	304
	4-Mar-2019	7.04	4,127	20.8	2.09	139
	26-Nov-2018	7.22	5,491	20.5	2.09	133
	31-Aug-2018	7.01	5,586	22.3	1.94	174
	24-May-2018	6.71	5,580	21.7	2.21	140
	22-Feb-2018	7.12	5,608	21.8	2.71	160
	17-Nov-2017	6.88	5,652	21.5	2.17	111
	31-Aug-2017	7.02	5,894	22.3	1.81	240
	30-May-2017	6.86	5,704	21.79	2.25	146.8
	1-Mar-2017	7.44	5,908	21.42	1.69	255.8
	17-Nov-2016	7.21	6,202	22.30	3.52	168.1
	29-Aug-2016	7.02	6,312	25.10	1.87	62.2
	27-May-2016	7.03	6,250	22.08	2.19	57.1
	18-Feb-2016	6.68	6,525	24.07	2.30	266.4
18-Nov-2015	7.01	5,810	21.86	2.02	222.2	
27-Aug-2015	7.07	6,630	22.51	NM	232.2	

**TABLE 2. SUMMARY OF MONITORING WELL GROUNDWATER FIELD PARAMETERS
DONA ANA DAIRIES, DONA ANA COUNTY, NEW MEXICO**

Monitoring Well	Date Measured	pH	SpC (uS/cm)	Temp (°C)	DO (mg/L)	ORP (mV)
833-08	16-May-2023	7.41	5,120	22.4	2.04	110
	22-Feb-2023	7.26	5,222	20.5	2.02	223
	18-Nov-2022	7.20	4,614	21.5	2.31	211
	18-Aug-2022	7.23	5,525	22.5	2.44	190
	18-May-2022	7.36	5,713	22.2	2.74	172
	10-Mar-2022	7.24	6,395	20.7	2.55	177
	16-Nov-2021	7.41	5,543	22.0	2.84	172
	18-Aug-2021	7.88	3,683	24.5	2.67	118
	18-May-2021	7.85	5,590	23.0	2.45	130
	24-Feb-2021	7.77	5,438	21.1	2.90	103
	18-Nov-2020	7.20	4,853	21.9	2.14	108
	24-Aug-2020	7.45	4,169	23.8	1.29	138
	19-May-2020	7.27	4,600	24.0	2.61	156
	17-Feb-2020	7.60	4,602	22.1	2.12	115
	20-Nov-2019	6.70	4,451	22.2	2.49	250
	14-Aug-2019	6.93	4,719	23.3	1.40	136
	23-May-2019	6.29	4,567	22.2	2.12	273
	5-Mar-2019	6.98	3,190	20.6	NM	148
	27-Nov-2018	6.89	4,561	20.6	2.71	167
	4-Sep-2018	7.10	4,366	22.7	1.07	140
	24-May-2018	6.54	4,524	23.2	3.17	100
	22-Feb-2018	7.44	4,723	22.2	3.88	148
	17-Nov-2017	7.28	4,892	22.2	4.12	121
	1-Sep-2017	7.02	5,284	21.8	3.03	127
	31-May-2017	6.83	4,910	22.6	2.02	163.4
	1-Mar-2017	7.27	4,896	21.37	2.69	228.6
	17-Nov-2016	7.02	5,660	22.79	6.85	139.1
	29-Aug-2016	7.05	4,300	25.90	2.08	55.3
	27-May-2016	7.02	3,480	22.11	5.99	61.6
	19-Feb-2016	6.79	3,422	22.54	3.67	225.3
18-Nov-2015	7.17	3,067	20.30	5.05	158.7	
27-Aug-2015	7.13	3,599	22.17	NM	222.4	
833-09	17-May-2023	7.27	5,911	21.9	2.44	156
	23-Feb-2023	7.24	5,642	20.5	2.44	157
	21-Nov-2022	7.24	6,119	20.8	2.20	181
	18-Aug-2022	7.37	7,003	22.0	2.55	132
	19-May-2022	7.23	6,610	21.6	2.55	202
	10-Mar-2022	7.56	6,018	21.3	1.89	208
	17-Nov-2021	7.30	5,953	20.3	2.80	230
	18-Aug-2021	7.81	6,211	22.0	2.93	116
	19-May-2021	7.70	4,274	21.8	2.69	130
	25-Feb-2021	7.45	4,242	20.6	2.85	103
	19-Nov-2020	7.45	4,292	21.4	2.90	121
	25-Aug-2020	7.77	4,626	25.7	2.03	224
	19-May-2020	7.34	4,651	22.0	2.73	144
	18-Feb-2020	7.45	4,521	20.9	2.83	107
	21-Nov-2019	7.00	4,527	20.0	4.56	283
	14-Aug-2019	7.11	4,764	21.6	0.71	89
	22-May-2019	7.21	4,511	21.0	2.40	297
	4-Mar-2019	7.40	4,259	19.5	2.29	140
	26-Nov-2018	7.02	4,839	20.4	2.61	135
	4-Sep-2018	7.02	4,801	21.0	1.66	182
	24-May-2018	6.85	4,846	21.2	2.58	157
	21-Feb-2018	7.41	4,896	21.8	2.26	151
	16-Nov-2017	7.23	4,685	20.6	2.86	158
	31-Aug-2017	7.11	4,997	20.5	1.43	161
	30-May-2017	7.00	4,859	21.06	2.84	141.2
	28-Feb-2017	7.40	5,026	20.37	1.48	172.5
	17-Nov-2016	7.35	5,118	21.06	2.53	121.1
	26-Aug-2016	7.00	5,060	24.20	1.37	41.1
	26-May-2016	7.26	4,718	20.61	1.70	41.6
	19-Feb-2016	8.02	5,601	19.84	1.83	219.5
18-Nov-2015	7.26	5,356	20.04	1.91	217.2	
27-Aug-2015	7.39	5,341	22.71	NM	214.8	

**TABLE 2. SUMMARY OF MONITORING WELL GROUNDWATER FIELD PARAMETERS
DONA ANA DAIRIES, DONA ANA COUNTY, NEW MEXICO**

Monitoring Well	Date Measured	pH	SpC (uS/cm)	Temp (°C)	DO (mg/L)	ORP (mV)
833-10	17-May-2023	7.32	4,289	19.1	2.09	131
	23-Feb-2023	7.30	4,306	18.4	2.63	158
	21-Nov-2022	7.28	4,339	18.7	1.96	165
	19-Aug-2022	7.20	4,341	19.5	2.40	177
	19-May-2022	7.32	4,340	19.8	2.66	176
	28-Feb-2022	7.23	4,356	18.0	2.38	207
	17-Nov-2021	7.76	4,301	18.4	2.38	178
	18-Aug-2021	7.81	4,248	19.8	2.76	101
	19-May-2021	7.37	4,181	20.0	2.49	161
	25-Feb-2021	7.63	4,047	19.0	1.83	108
	19-Nov-2020	7.39	4,071	20.8	1.57	128
	25-Aug-2020	7.30	4,142	21.0	1.43	198
	20-May-2020	7.22	4,180	21.5	2.63	162
	18-Feb-2020	7.51	3,974	19.2	1.89	122
	21-Nov-2019	6.50	3,921	19.7	5.82	235
	14-Aug-2019	7.31	4,002	20.2	0.63	125
	22-May-2019	6.74	3,907	19.3	2.28	307
	4-Mar-2019	7.03	3,406	17.9	2.40	127
	26-Nov-2018	6.92	3,903	18.1	2.24	148
	31-Aug-2018	7.30	3,841	19.1	2.55	169
	24-May-2018	7.41	3,927	19.3	2.89	123
	22-Feb-2018	7.57	3,878	18.6	2.77	150
	16-Nov-2017	7.04	3,899	18.5	3.27	156
	31-Aug-2017	6.98	3,992	19.7	2.36	212
	30-May-2017	6.72	3,623	19.07	1.81	182.8
	1-Mar-2017	7.40	3,988	18.19	1.47	248.6
	17-Nov-2016	7.15	3,764	18.50	0.62	129.9
26-Aug-2016	7.00	3,856	20.10	1.77	55.6	
26-May-2016	7.16	3,609	19.39	2.94	46.7	
19-Feb-2016	7.93	3,617	19.11	2.71	220.8	
18-Nov-2015	7.21	3,600	19.11	2.08	210.6	
27-Aug-2015	7.14	3,861	19.7	NM	231.7	
Sunset/Desert Land Dairy						
257-01	17-May-2023	7.29	5,394	20.2	2.28	134
	24-Feb-2023	7.22	5,432	19.7	2.73	148
	22-Nov-2022	7.29	5,470	20.0	1.94	168
	19-Aug-2022	7.28	5,478	19.8	1.78	128
	19-May-2022	7.20	5,520	20.3	1.97	259
	28-Feb-2022	7.48	5,522	19.8	2.15	195
	17-Nov-2021	7.80	5,521	20.8	2.74	226
	19-Aug-2021	7.92	5,476	21.8	2.51	46
	20-May-2021	7.73	5,508	20.1	2.58	150
	25-Feb-2021	7.78	5,377	20.0	2.64	97
	20-Nov-2020	7.70	5,505	21.1	1.73	131
	25-Aug-2020	7.41	5,740	21.0	2.08	182
	26-May-2020	7.76	5,705	20.1	2.34	231
	18-Feb-2020	7.81	5,375	19.5	1.80	135
	21-Nov-2019	6.77	5,461	20.7	1.78	226
	6-Aug-2019	7.16	5,844	20.8	NM	174
	21-May-2019	6.71	5,643	18.7	1.30	292
	1-Mar-2019	7.27	4,790	19.7	1.17	181
	27-Nov-2018	7.52	5,784	20.2	1.76	168
	23-Aug-2018	7.58	5,739	21.2	2.25	146
	23-May-2018	7.14	5,797	19.0	2.36	101
	20-Feb-2018	7.56	5,809	19.9	2.84	146
	16-Nov-2017	7.37	5,800	20.3	2.59	156
	18-Aug-2017	7.58	5,774	20.2	3.49	176
	31-May-2017	6.65	5,255	19.9	1.74	121.4
	2-Mar-2017	7.62	5,357	19.24	1.46	183.3
	16-Nov-2016	7.76	5,484	20.63	2.10	36.7
25-Aug-2016	7.08	5,297	20.04	3.23	26.1	
26-May-2016	7.42	4,809	18.91	3.47	17.2	
22-Feb-2016	7.46	4,942	19.56	2.51	171.8	
19-Nov-2015	7.48	4,943	20.16	2.27	184.9	
28-Aug-2015	7.47	5,032	21.14	NM	189.4	

**TABLE 2. SUMMARY OF MONITORING WELL GROUNDWATER FIELD PARAMETERS
DONA ANA DAIRIES, DONA ANA COUNTY, NEW MEXICO**

Monitoring Well	Date Measured	pH	SpC (uS/cm)	Temp (°C)	DO (mg/L)	ORP (mV)
257-02	18-May-2023	7.25	4,242	18.2	2.17	160
	24-Feb-2023	7.35	4,388	18.5	2.01	67
	22-Nov-2022	7.27	4,238	20.7	2.18	215
	19-Aug-2022	7.30	4,270	21.1	1.31	133
	19-May-2022	7.50	4,233	19.8	2.18	150
	28-Feb-2022	7.62	3,607	18.3	2.72	147
	18-Nov-2021	7.80	5,215	20.4	1.73	123
	20-Aug-2021	7.83	3,610	21.1	2.79	184
	19-May-2021	7.63	4,545	23.6	2.90	182
	26-Feb-2021	7.65	4,422	17.7	2.55	126
	20-Nov-2020	7.58	4,431	21.9	2.18	187
	26-Aug-2020	7.58	4,473	21.5	1.51	173
	26-May-2020	7.28	4,560	20.2	2.96	177
	18-Feb-2020	7.43	3,981	19.5	2.94	150
	21-Nov-2019	6.86	3,928	20.8	4.14	246
	6-Aug-2019	7.16	4,009	21.2	NM	198
	21-May-2019	6.49	3,844	17.7	1.19	294
	1-Mar-2019	6.99	3,707	19.0	2.11	169
	27-Nov-2018	7.37	4,017	20.3	2.46	155
	23-Aug-2018	7.29	3,996	21.3	2.46	123
	23-May-2018	6.99	3,969	18.8	2.91	122
	20-Feb-2018	7.48	3,943	18.8	4.23	155
	16-Nov-2017	7.20	3,991	20.9	3.29	117
	18-Aug-2017	7.36	4,326	20.9	4.86	150
	31-May-2017	6.65	3,585	19.37	1.87	151.5
	2-Mar-2017	7.72	3,828	18.45	1.67	231.1
	16-Nov-2016	7.74	4,378	21.28	4.37	85.1
	25-Aug-2016	6.94	3,244	21.03	5.64	42.9
26-May-2016	7.24	3,183	18.32	3.78	84.3	
22-Feb-2016	7.75	2,582	20.01	3.44	142.7	
19-Nov-2015	7.41	4,064	21.09	3.38	204.7	
28-Aug-2015	7.27	3,912	21.30	NM	243.8	
257-03	17-May-2023	Dry				
	23-Feb-2023	Dry				
	22-Nov-2022	7.22	3,940	19.6	2.03	230
	22-Aug-2022	7.19	3,887	24.0	2.03	145
	19-May-2022	Unknown Blockage in Well -Parameters Not Collected				
	28-Feb-2022	Unknown Blockage in Well -Parameters Not Collected				
	18-Nov-2021	Unknown Blockage in Well -Parameters Not Collected				
	20-Aug-2021	7.26	4,124	23.0	2.99	102
	20-May-2021	Insufficient Water-Parameters Not Collected				
	26-Feb-2021	7.48	4,189	17.1	2.87	144
	20-Nov-2020	7.20	4,196	21.4	2.93	190
	26-Aug-2020	7.23	4,444	22.4	1.30	165
	26-May-2020	Dry				
	18-Feb-2020	7.22	4,041	17.8	2.38	121
	21-Nov-2019	6.51	3,901	19.6	3.30	244
	6-Aug-2019	6.80	4,514	23.8	NM	272
	21-May-2019	Dry				
	1-Mar-2019	7.17	4,021	18.9	2.28	153
	27-Nov-2018	7.13	3,954	19.7	2.08	160
	23-Aug-2018	7.14	4,200	22.2	1.89	158
	23-May-2018	7.72	3,323	20.1	2.08	64
	20-Feb-2018	7.18	3,755	17.0	1.89	131
	16-Nov-2017	7.14	3,182	20.2	3.11	141
	18-Aug-2017	7.09	3,943	20.6	2.61	247
	31-May-2017	6.48	3,569	20.51	1.68	130
	2-Mar-2017	7.28	3,164	16.57	1.98	251.7
	16-Nov-2016	7.42	2,952	21.12	3.66	90.8
	25-Aug-2016	6.81	2,786	22.39	1.03	27.2
26-May-2016	Dry					
22-Feb-2016	Insufficient Water-Parameters Not Collected					
19-Nov-2015	Dry					
28-Aug-2015	7.34	3,520	24.08	NM	241.6	

**TABLE 2. SUMMARY OF MONITORING WELL GROUNDWATER FIELD PARAMETERS
DONA ANA DAIRIES, DONA ANA COUNTY, NEW MEXICO**

Monitoring Well	Date Measured	pH	SpC (uS/cm)	Temp (°C)	DO (mg/L)	ORP (mV)
257/260-01	20-Feb-2018	Plugged and Abandoned				
	16-Nov-2017	Could Not Access				
	18-Aug-2017	7.55	4,786	20.60	3.03	-217.0
	31-May-2017	10.01	3,974	20.41	3.65	-194.9
	2-Mar-2017	7.97	3,961	18.11	-0.10	-282.3
	16-Nov-2016	8.95	3,111	20.01	4.10	-172.7
	9-Sep-2016	7.36	2,580	23.10	1.78	NM
	26-May-2016	7.70	3,141	17.96	0.81	-180.0
	22-Feb-2016	7.61	3,755	18.22	0.00	-312.4
	19-Nov-2015	7.90	3,217	19.97	0.98	-97.6
	28-Aug-2015	7.66	1,840	21.64	NM	194.4
Las Cruces Community Farms (Former McAnally Enterprises)						
MW-4	18-May-2023	7.28	7,182	22.1	1.66	129
	24-Feb-2023	7.43	6,680	21.2	1.88	109
	22-Nov-2022	7.37	7,172	21.2	2.79	164
	22-Aug-2022	7.38	7,741	22.3	2.66	114
	20-May-2022	7.18	6,393	22.0	2.05	196
	28-Feb-2022	7.38	6,399	21.6	2.30	162
	18-Nov-2021	7.57	5,852	21.1	2.87	121
	20-Aug-2021	7.71	6,360	22.8	2.55	87
	20-May-2021	7.68	6,189	22.2	2.93	106
	26-Feb-2021	7.20	6,790	21.4	2.95	104
	20-Nov-2020	7.58	6,914	22.3	2.83	159
	26-Aug-2020	7.24	7,221	22.4	1.93	144
	26-May-2020	7.33	6,976	22.4	2.91	172
	6-Mar-2020	7.52	7,037	21.7	1.45	179
	26-Nov-2019	6.61	7,084	21.1	3.87	71
SOUTHERN AREA						
Del Oro Dairy						
692-01	24-Feb-2016	Plugged and Abandoned				
	2-Dec-2015	6.95	3,550	20.70	1.43	157.5
	31-Aug-2015	Pump Not Operational-Parameters Not Collected				
692-02	18-May-2023	7.29	2,618	23.8	1.90	123
	27-Feb-2023	7.21	2,410	21.1	1.69	161
	22-Aug-2022	7.47	2,061	24.5	1.62	99
	20-May-2022	7.66	1,785	23.7	1.31	186
	1-Mar-2022	7.20	1,782	22.0	1.32	215
	19-Nov-2021	7.10	1,589	22.7	1.20	256
	23-Aug-2021	7.22	1,566	24.6	1.15	99
	20-May-2021	7.79	1,536	25.0	1.97	137
	9-Mar-2021	7.89	1,498	23.1	1.08	214
	23-Nov-2020	7.31	1,499	24.1	1.09	237
	26-Aug-2020	7.51	1,539	25.4	1.10	200
	26-May-2020	7.56	1,561	25.8	1.18	150
	19-Feb-2020	7.70	1,463	23.6	2.71	161
	2-Dec-2019	7.64	1,444	24.4	2.28	207
	15-Aug-2019	7.20	2,001	27.2	2.28	96
	29-May-2019	7.05	1,588	23.4	3.02	231
	7-Mar-2019	6.72	2,692	21.8	2.70	141
	27-Nov-2018	6.60	3,697	21.8	3.11	173
	23-Aug-2018	6.70	3,937	22.8	3.76	125
	30-May-2018	6.29	4,040	21.8	4.28	134
	23-Feb-2018	7.06	4,371	21.7	5.17	160
	30-Nov-2017	6.84	3,882	20.4	6.88	169
	23-Aug-2017	6.83	3,617	22.9	3.10	154
	5-Jun-2017	6.70	2,612	22.06	3.72	179.9
	2-Mar-2017	7.00	3,418	21.09	2.04	233.5
	30-Nov-2016	6.43	4,957	22.45	0.50	151.1
	6-Sep-2016	6.99	4,980	22.50	2.97	NM
31-May-2016	6.79	4,861	21.60	1.77	53.2	
24-Feb-2016	6.49	4,818	20.64	1.46	335.4	
2-Dec-2015	6.90	4,801	20.76	1.61	163.4	
31-Aug-2015	6.72	5,119	22.51	NM	198.1	

**TABLE 2. SUMMARY OF MONITORING WELL GROUNDWATER FIELD PARAMETERS
DONA ANA DAIRIES, DONA ANA COUNTY, NEW MEXICO**

Monitoring Well	Date Measured	pH	SpC (uS/cm)	Temp (°C)	DO (mg/L)	ORP (mV)
692-04	18-May-2023	Dry				
	27-Feb-2023	Dry				
	23-Aug-2022	Insufficient Water-Parameters Not Collected				
	20-May-2022	7.30	4,133	23.2	2.00	198
	1-Mar-2022	7.18	3,530	21.0	2.67	221
	19-Nov-2021	7.12	3,390	20.0	2.59	195
	20-Aug-2021	7.81	3,483	24.5	2.61	74
	20-May-2021	Insufficient Water-Parameters Not Collected				
	9-Mar-2021	7.41	3,104	22.0	2.36	154
	23-Nov-2020	7.52	3,442	21.7	2.49	175
	26-Aug-2020	7.66	3,580	25.2	2.66	193
	26-May-2020	7.63	4,815	24.2	2.91	177
	19-Feb-2020	7.15	3,736	20.1	2.50	202
	2-Dec-2019	6.30	3,423	20.0	1.76	248
	15-Aug-2019	6.78	3,564	22.7	2.03	108
	29-May-2019	Dry				
	7-Mar-2019	Dry				
	27-Nov-2018	Dry				
	23-Aug-2018	Dry				
	30-May-2018	Dry				
	23-Feb-2018	Dry				
	30-Nov-2017	Dry				
	23-Aug-2017	Dry				
	5-Jun-2017	Dry				
	2-Mar-2017	Dry				
	30-Nov-2016	Dry				
	2-Sep-2016	Dry				
	31-May-2016	Dry				
	24-Feb-2016	Dry				
	2-Dec-2015	Dry				
31-Aug-2015	Dry					
692-05*	23-May-2023	7.26	2,470	22.2	1.80	122
	28-Feb-2023	7.22	2,462	21.3	1.87	180
	23-Aug-2022	7.28	2,510	26.8	1.82	157
	20-May-2022	7.38	2,453	24.6	1.82	237
	2-Mar-2022	7.19	2,444	20.3	1.88	214
	19-Nov-2021	7.30	2,531	22.0	1.90	185
	23-Aug-2021	7.13	2,473	24.4	1.79	136
	21-May-2021	7.66	2,467	23.0	1.85	116
	9-Mar-2021	7.43	2,429	21.9	1.80	132
	23-Nov-2020	7.30	2,382	22.4	1.81	221
	27-Aug-2020	7.36	2,491	23.0	1.88	203
	27-May-2020	7.18	2,488	23.1	1.80	187
	19-Feb-2020	7.68	2,349	19.8	2.33	181
	2-Dec-2019	6.55	2,350	20.2	0.79	205
	16-Aug-2019	7.03	2,442	23.7	1.04	90
	29-May-2019	6.80	2,429	23.9	4.24	254
	14-Mar-2019	6.96	1,787	21.6	4.11	191
	4-Dec-2018	Pump Not Operational-Parameters Not Collected				
	23-Aug-2018	6.97	2,430	24.3	4.11	166
	30-May-2018	Pump Not Operational-Parameters Not Collected				
	23-Feb-2018	Pump Not Operational-Parameters Not Collected				
	30-Nov-2017	7.64	2,457	21.1	5.99	164
	22-Aug-2017	7.40	2,429	23.8	6.00	88
	5-Jun-2017	7.19	2,341	22.41	5.29	187.3
	3-Mar-2017	7.67	2,309	20.53	2.48	202.4
	29-Nov-2016	7.53	2,265	20.70	7.88	104.4
	2-Sep-2016	7.22	2,510	23.20	7.09	NM
	31-May-2016	7.54	2,216	21.44	5.74	63.6
	24-Feb-2016	7.01	2,199	20.55	6.20	196.9
	2-Dec-2015	7.58	2,127	18.67	13.45	242.9
31-Aug-2015	7.92	2,713	31.25	NM	124.7	

**TABLE 2. SUMMARY OF MONITORING WELL GROUNDWATER FIELD PARAMETERS
DONA ANA DAIRIES, DONA ANA COUNTY, NEW MEXICO**

Monitoring Well	Date Measured	pH	SpC (uS/cm)	Temp (°C)	DO (mg/L)	ORP (mV)
692-06	23-May-2023	7.29	2,272	24.1	1.73	141
	28-Feb-2023	7.29	2,342	21.1	1.77	238
	23-Aug-2022	7.30	2,312	23.3	1.72	207
	23-May-2022	7.22	2,276	22.4	1.71	185
	2-Mar-2022	7.21	2,288	21.5	1.74	213
	22-Nov-2021	7.30	2,326	21.2	1.76	247
	24-Aug-2021	7.73	2,305	25.3	1.73	52
	21-May-2021	7.65	2,322	21.9	1.71	177
	11-Mar-2021	7.84	2,199	22.1	1.69	171
	24-Nov-2020	7.67	2,276	21.2	1.71	104
	27-Aug-2020	7.50	2,350	23.8	1.73	244
	27-May-2020	7.42	2,431	26.4	1.72	126
	18-Feb-2020	7.60	2,186	23.0	2.60	123
	26-Nov-2019	6.91	2,230	19.7	9.98	184
	15-Aug-2019	7.15	2,311	23.7	2.27	166
	29-May-2019	6.71	2,230	23.6	4.37	293
	7-Mar-2019	6.90	2,260	22.0	4.10	115
	4-Dec-2018	7.07	1,734	18.1	3.81	130
	23-Aug-2018	6.74	2,294	22.4	4.61	202
	30-May-2018	6.64	2,305	23.2	5.11	69
	27-Feb-2018	7.60	2,297	22.6	3.62	113
	30-Nov-2017	7.30	2,319	20.7	4.01	185
	23-Aug-2017	7.17	2,351	22.6	4.27	139
	5-Jun-2017	7.09	2,258	22.45	3.74	123.8
	2-Mar-2017	7.30	2,295	21.69	2.82	251.2
	30-Nov-2016	6.86	2,297	22.49	6.12	242.1
	6-Sep-2016	7.72	2,410	22.00	5.24	NM
	31-May-2016	7.29	2,085	21.69	4.84	79.0
	24-Feb-2016	7.16	2,147	20.61	3.78	167.3
	1-Dec-2015	7.31	2,147	20.76	2.17	95.2
31-Aug-2015	7.44	2,420	25.12	NM	119.7	
692-07*	24-May-2023	7.32	2,490	22.5	1.86	141
	28-Feb-2023	7.43	2,537	21.2	1.88	152
	24-Aug-2022	7.26	2,499	22.5	1.86	181
	23-May-2022	7.26	2,505	22.1	1.88	169
	2-Mar-2022	7.30	2,492	20.9	1.88	198
	22-Nov-2021	7.36	2,529	22.1	1.88	110
	24-Aug-2021	7.60	2,571	24.6	1.87	80
	21-May-2021	7.73	2,575	23.5	1.92	170
	11-Mar-2021	7.33	2,450	21.4	1.87	244
	24-Nov-2020	7.52	4,503	21.6	1.44	226
	27-Aug-2020	7.10	2,632	22.5	1.92	194
	27-May-2020	7.33	2,644	24.0	1.95	46
	19-Feb-2020	7.89	2,504	17.1	3.45	156
	26-Nov-2019	7.16	2,597	19.5	4.35	227
	16-Aug-2019	7.51	2,625	24.1	3.75	-51
	29-May-2019	6.99	2,553	22.3	4.61	287
	7-Mar-2019	7.00	2,553	20.6	4.39	111
	4-Dec-2018	7.13	2,585	20.0	4.68	115
	23-Aug-2018	7.38	2,563	24.3	6.23	90
	30-May-2018	7.33	2,602	23.2	7.04	35
	23-Feb-2018	7.67	2,623	20.8	7.26	79
	30-Nov-2017	7.56	2,594	20.3	7.11	116
	22-Aug-2017	7.22	2,586	25.3	5.23	89.0
	5-Jun-2017	7.16	2,549	23.27	5.40	226.4
	3-Mar-2017	7.63	2,496	20.38	3.78	259.5
	29-Nov-2016	7.11	2,504	20.48	8.19	87.6
	2-Sep-2016	7.40	2,680	24.80	7.04	NM
	31-May-2016	7.53	2,440	22.55	3.71	42.5
	24-Feb-2016	7.18	2,390	20.66	7.90	165.7
	2-Dec-2015	7.68	2,189	17.55	7.20	245.8
31-Aug-2015	7.37	2,667	25.70	NM	132.9	

**TABLE 2. SUMMARY OF MONITORING WELL GROUNDWATER FIELD PARAMETERS
DONA ANA DAIRIES, DONA ANA COUNTY, NEW MEXICO**

Monitoring Well	Date Measured	pH	SpC (uS/cm)	Temp (°C)	DO (mg/L)	ORP (mV)
692-08*	24-May-2023	7.31	2,177	30.1	1.62	52
	1-Mar-2023	7.29	2,201	25.0	1.63	150
	24-Aug-2022	7.28	2,182	27.8	1.63	-95
	23-May-2022	7.27	2,242	31.1	1.60	277
	2-Mar-2022	7.51	2,222	26.1	1.63	26
	22-Nov-2021	7.81	2,251	27.9	1.62	12
	24-Aug-2021	7.65	2,220	30.1	1.60	59
	21-May-2021	7.77	2,189	23.3	1.64	147
	11-Mar-2021	7.43	2,153	24.2	1.60	152
	24-Nov-2020	7.34	2,111	22.0	1.60	231
	27-Aug-2020	7.25	2,195	24.7	1.60	178
	27-May-2020	7.11	2,205	23.8	1.59	248
	18-Feb-2020	7.52	2,196	22.8	1.20	133
	25-Nov-2019	7.14	2,610	19.1	4.10	224
	16-Aug-2019	6.98	2,188	23.5	2.94	184
	29-May-2019	6.69	2,160	21.8	5.38	264
	7-Mar-2019	6.83	2,194	20.4	5.61	159
	4-Dec-2018	6.67	2,217	19.6	5.94	179
	23-Aug-2018	7.31	2,172	23.2	6.74	159
	30-May-2018	6.97	2,200	23.9	6.92	82
	23-Feb-2018	7.54	2,215	21.0	7.13	143
	30-Nov-2017	7.51	2,160	20.6	6.57	198
	22-Aug-2017	7.55	2,191	24.3	5.09	98
	5-Jun-2017	6.62	2,133	22.68	4.78	110.2
	3-Mar-2017	6.88	2,164	21.09	3.56	249.1
	30-Nov-2016	6.90	2,148	21.44	3.63	368.2
	2-Sep-2016	6.92	2,270	22.80	6.89	NM
	31-May-2016	7.12	2,074	22.73	5.11	48.0
24-Feb-2016	7.27	2,072	21.71	7.27	312.5	
1-Dec-2015	7.30	2,009	20.67	8.14	234.2	
31-Aug-2015	7.25	2,385	23.15	NM	134.7	
692-09*	23-May-2023	7.30	2,300	24.0	1.66	147
	28-Feb-2023	7.20	2,281	23.5	1.69	154
	23-Aug-2022	7.23	2,258	24.7	1.56	161
	20-May-2022	7.51	2,264	26.5	1.78	180
	1-Mar-2022	7.59	2,281	22.9	1.89	199
	19-Nov-2021	7.40	2,257	23.4	1.60	146
	23-Aug-2021	7.21	2,245	24.3	1.65	111
	20-May-2021	7.44	2,232	23.8	1.59	184
	9-Mar-2021	7.73	2,200	23.4	1.65	124
	23-Nov-2020	7.40	2,156	23.0	1.64	190
	26-Aug-2020	7.26	2,267	24.0	1.62	237
	27-May-2020	7.30	2,240	23.1	1.67	265
	19-Feb-2020	7.75	2,234	17.6	2.84	191
	2-Dec-2019	7.02	2,151	20.1	1.10	182
	16-Aug-2019	7.14	2,241	23.2	2.32	91
	29-May-2019	6.96	2,149	22.9	5.80	232
	7-Mar-2019	7.04	2,211	22.2	5.89	136
	4-Dec-2018	7.52	2,229	20.1	6.11	132
	23-Aug-2018	7.40	2,172	23.1	5.44	111
	30-May-2018	6.91	2,211	23.0	5.21	127
	23-Feb-2018	7.58	2,211	22.1	4.38	143
	30-Nov-2017	7.32	2,196	22.3	5.75	228
	22-Aug-2017	7.25	2,231	24.0	4.28	104
	5-Jun-2017	7.22	2,163	23.19	5.07	156.4
	3-Mar-2017	7.30	2,240	22.24	3.26	257.8
	30-Nov-2016	7.13	2,221	22.09	6.02	103.1
	2-Sep-2016	7.14	2,310	23.50	6.03	NM
	31-May-2016	7.35	2,106	22.81	4.68	62.3
24-Feb-2016	7.06	2,111	22.18	5.54	208.6	
2-Dec-2015	7.65	2,015	18.78	8.02	155.9	
31-Aug-2015	7.57	2,420	27.64	NM	168.5	
692-10	24-May-2023	7.25	2,764	24.20	2.07	123
	1-Mar-2023	7.26	2,797	21.40	2.20	115

**TABLE 2. SUMMARY OF MONITORING WELL GROUNDWATER FIELD PARAMETERS
DONA ANA DAIRIES, DONA ANA COUNTY, NEW MEXICO**

Monitoring Well	Date Measured	pH	SpC (uS/cm)	Temp (°C)	DO (mg/L)	ORP (mV)
Anthony Waste Water Treatment Plant						
MW-1	Aug-2015	Parameters Not Collected Since August 2015				
MW-2	Aug-2015	Parameters Not Collected Since August 2015				
MW-3	Aug-2015	Parameters Not Collected Since August 2015				
ABATEMENT PLAN MONITOR WELLS						
DAD-01	25-May-2023	7.25	2,467	24.7	1.71	155
	2-Mar-2023	7.20	3,215	20.9	1.85	132
	1-Dec-2022	7.34	2,431	24.0	1.85	148
	24-Aug-2022	7.43	2,240	25.5	1.76	112
	24-May-2022	7.24	2,507	24.3	1.71	203
	3-Mar-2022	7.19	2,696	24.0	1.85	200
	23-Nov-2021	7.54	2,516	23.9	1.82	118
	25-Aug-2021	7.11	2,330	24.9	1.76	146
	1-Jun-2021	7.19	2,250	24.5	1.71	219
	26-Feb-2021	7.59	2,706	23.5	1.79	132
	30-Nov-2020	7.31	2,401	24.0	1.69	308
	27-Aug-2020	7.43	2,290	25.8	1.56	140
	29-May-2020	7.51	2,149	25.5	1.50	132
	21-Feb-2020	7.08	2,347	23.5	0.21	170
	3-Dec-2019	6.57	2,280	22.5	1.35	193
	19-Aug-2019	7.11	2,146	25.3	2.94	96
	22-May-2019	7.03	2,099	24.8	1.11	288
	5-Mar-2019	7.28	2,352	23.9	1.13	127
	28-Nov-2018	7.11	2,221	23.5	1.31	147
	24-Aug-2018	6.79	2,101	25.3	1.14	222
	31-May-2018	7.20	2,084	24.1	1.36	115
	26-Feb-2018	7.44	2,458	22.8	3.17	129
	20-Nov-2017	7.39	2,414	24.6	5.07	131
	24-Aug-2017	7.30	2,436	25.0	5.57	167
8-Jun-2017	6.93	2,383	25.27	3.40	206.7	
7-Mar-2017	7.23	2,688	23.27	2.40	217.1	
30-Nov-2016	7.09	2,728	24.10	5.82	239.2	
6-Sep-2016	7.24	2,740	25.30	6.16	NM	
2-Jun-2016	7.02	2,521	24.87	6.19	98.6	
25-Feb-2016	6.78	2,785	24.29	3.75	198.6	
23-Nov-2015	7.21	2,636	22.29	4.60	-7.4	
1-Sep-2015	7.28	2,406	24.74	NM	255.7	

**TABLE 2. SUMMARY OF MONITORING WELL GROUNDWATER FIELD PARAMETERS
DONA ANA DAIRIES, DONA ANA COUNTY, NEW MEXICO**

Monitoring Well	Date Measured	pH	SpC (uS/cm)	Temp (°C)	DO (mg/L)	ORP (mV)
DAD-02	26-May-2023	7.28	2,750	25.1	1.99	101
	3-Mar-2023	7.31	2,413	23.3	1.84	141
	5-Dec-2022	7.35	2,440	23.1	1.88	173
	26-Aug-2022	7.50	2,348	24.7	1.73	80
	25-May-2022	7.60	2,040	24.5	1.57	146
	16-Mar-2022	7.22	1,856	23.3	1.33	179
	30-Nov-2021	7.83	1,821	23.5	1.30	121
	26-Aug-2021	7.71	1,802	25.3	1.36	153
	3-Jun-2021	7.81	1,807	25.1	1.35	182
	2-Mar-2021	7.86	1,678	23.2	1.22	134
	1-Dec-2020	7.47	1,803	17.3	0.94	167
	28-Aug-2020	7.78	1,896	26.0	1.36	132
	29-May-2020	7.41	1,837	25.1	1.35	107
	21-Feb-2020	7.64	1,770	22.3	0.30	135
	4-Dec-2019	6.83	1,711	22.6	2.15	167
	19-Aug-2019	7.38	1,895	24.3	3.17	97
	22-May-2019	7.14	1,862	24.5	1.23	296
	4-Mar-2019	7.32	2,015	23.2	1.31	136
	28-Nov-2018	7.18	2,258	23.2	1.44	156
	24-Aug-2018	7.10	2,325	24.4	1.63	218
	31-May-2018	7.38	2,412	24.1	2.06	111
	26-Feb-2018	7.51	2,652	23.2	2.47	142
	20-Nov-2017	7.30	2,632	23.3	5.75	166
	24-Aug-2017	7.40	2,510	25.1	5.35	73
	8-Jun-2017	6.91	2,606	24.78	4.78	171.8
	7-Mar-2017	7.42	2,727	23.27	2.96	208.2
	30-Nov-2016	7.20	2,535	22.82	6.93	134.3
	6-Sep-2016	7.83	2,570	24.40	6.78	NM
	2-Jun-2016	7.20	2,454	24.80	5.21	79.4
	25-Feb-2016	7.22	2,480	22.99	6.08	203.6
23-Nov-2015	7.31	2,454	22.81	5.28	95.5	
31-Aug-2015	7.48	2,633	25.05	NM	220.6	
DAD-03	26-May-2023	7.31	2,600	21.6	1.28	93
	6-Mar-2023	7.34	2,693	21.3	1.99	134
	5-Dec-2022	7.31	2,656	22.0	1.93	98
	26-Aug-2022	7.42	2,633	22.9	1.95	61
	26-May-2022	7.24	2,658	20.2	1.96	194
	16-Mar-2022	7.15	2,780	20.1	2.09	198
	1-Dec-2021	7.54	2,618	22.0	1.98	85
	26-Aug-2021	7.77	2,961	23.6	2.28	-122
	3-Jun-2021	7.58	2,720	20.9	1.97	192
	1-Dec-2020	7.62	2,404	21.7	1.73	-73
	31-Aug-2020	7.70	2,622	22.9	2.22	140
	1-Jun-2020	7.47	2,557	20.7	1.89	157
	21-Feb-2020	7.63	2,461	20.0	0.29	123
	4-Dec-2019	7.13	2,613	21.5	3.49	-40
	19-Aug-2019	7.30	2,731	22.4	1.49	-28
	22-May-2019	7.16	2,839	20.3	2.53	287
	5-Mar-2019	7.34	2,651	19.8	2.60	149
	28-Nov-2018	7.65	2,700	22.1	3.10	152
	24-Aug-2018	7.39	2,953	22.4	2.56	58
	31-May-2018	6.97	3,152	20.3	2.30	83
	26-Feb-2018	7.63	2,952	20.5	2.11	145
	20-Nov-2017	7.25	3,238	22.8	1.48	121
	24-Aug-2017	7.23	3,259	22.4	1.67	-96
	8-Jun-2017	6.79	3,035	21.24	5.23	-13.6
	7-Mar-2017	7.52	3,727	20.11	1.88	216.7
	30-Nov-2016	7.41	3,983	21.72	5.03	-20.9
	6-Sep-2016	7.36	3,750	23.10	2.32	NM
	2-Jun-2016	7.11	3,397	23.72	2.01	61.9
	25-Feb-2016	7.26	3,160	19.80	0.62	-97.8
	23-Nov-2015	7.33	3,365	21.04	1.30	-47.3
1-Sep-2015	7.37	4,085	23.27	NM	225.8	

**TABLE 2. SUMMARY OF MONITORING WELL GROUNDWATER FIELD PARAMETERS
DONA ANA DAIRIES, DONA ANA COUNTY, NEW MEXICO**

Monitoring Well	Date Measured	pH	SpC (uS/cm)	Temp (°C)	DO (mg/L)	ORP (mV)
DAD-04	30-May-2023	Dry				
	6-Mar-2023					
	6-Dec-2022	7.21	3,136	19.0	2.44	182
	31-Aug-2022	7.25	1,334	21.6	1.01	102
	26-May-2022	7.36	1,935	19.4	1.42	187
	16-Mar-2022	7.26	3,629	18.9	2.80	175
	1-Dec-2021	7.78	3,550	20.6	2.72	111
	31-Aug-2021	7.50	3,580	22.1	2.69	140
	3-Jun-2021	7.80	3,555	19.3	2.65	150
	2-Mar-2021	7.92	3,240	18.4	2.48	102
	2-Dec-2020	7.82	3,071	19.4	2.36	146
	31-Aug-2020	7.10	3,180	22.5	2.32	119
	1-Jun-2020	7.35	3,002	20.1	2.16	130
	21-Feb-2020	7.81	2,752	18.1	0.27	46
	4-Dec-2019	7.08	3,000	19.3	2.45	-39
	19-Aug-2019	7.68	2,692	22.8	1.74	-47
	23-May-2019	6.69	2,739	19.0	1.33	213
	5-Mar-2019	7.66	2,701	18.1	1.58	142
	28-Nov-2018	7.53	2,748	19.7	1.86	121
	24-Aug-2018	7.77	2,583	21.0	1.59	25
	31-May-2018	7.43	2,667	20.7	1.20	60
	26-Feb-2018	7.66	2,270	18.4	1.84	83
	20-Nov-2017	8.45	1,429	20.9	3.79	29
	24-Aug-2017	7.45	2,986	21.2	NM	78
	8-Jun-2017	6.84	2,696	21.48	2.64	209.2
	7-Mar-2017	7.80	2,486	19.56	1.80	214.6
	2-Dec-2016	7.60	2,843	20.58	5.46	216.8
	6-Sep-2016	7.75	3,040	22.10	3.57	NM
	2-Jun-2016	7.16	3,129	20.67	3.12	39.4
	25-Feb-2016	7.52	2,191	18.39	3.45	84.7
	23-Nov-2015	7.68	2,587	19.50	1.92	-29.6
	1-Sep-2015	7.76	3,591	22.82	NM	164.8

**TABLE 2. SUMMARY OF MONITORING WELL GROUNDWATER FIELD PARAMETERS
DONA ANA DAIRIES, DONA ANA COUNTY, NEW MEXICO**

Monitoring Well	Date Measured	pH	SpC (uS/cm)	Temp (°C)	DO (mg/L)	ORP (mV)
DAD-05	1-Jun-2023	7.27	1,350	19.3	1.05	97
	8-Mar-2023	7.29	1,351	18.4	1.05	100
	8-Dec-2022	7.33	1,305	20.0	0.93	60
	12-Sep-2022	7.25	1,231	21.8	1.04	80
	31-May-2022	7.22	2,294	18.2	1.62	31
	17-Mar-2022	7.40	2,377	17.5	1.75	81
	6-Dec-2021	7.20	2,564	19.0	1.84	-79
	2-Sep-2021	7.58	3,147	21.9	2.32	157
	7-Jun-2021	7.64	2,640	19.2	1.32	92
	4-Mar-2021	7.84	2,231	17.1	1.53	156
	2-Dec-2020	7.65	2,210	19.3	1.93	168
	31-Aug-2020	7.68	1,590	23.0	1.15	91
	1-Jun-2020	7.49	2,381	19.9	1.51	106
	21-Feb-2020	7.66	2,603	17.3	0.25	87
	5-Dec-2019	7.31	2,334	19.6	2.50	137
	22-Aug-2019	7.53	2,838	20.2	2.88	85
	23-May-2019	6.84	3,379	17.1	2.06	286
	5-Mar-2019	7.57	2,898	16.8	2.51	147
	29-Nov-2018	7.51	3,911	19.9	1.28	172
	24-Aug-2018	7.45	4,335	20.0	2.91	90
	31-May-2018	7.00	4,244	15.8	3.45	60
	26-Feb-2018	7.23	4,209	16.7	4.67	112
	27-Nov-2017	7.28	4,252	20.1	1.62	138
	25-Aug-2017	7.53	2,517	20.6	3.72	187
	8-Jun-2017	6.53	3,839	17.82	2.77	38.3
	7-Mar-2017	7.41	2,997	17.25	2.27	231.3
	2-Dec-2016	7.09	3,954	19.60	1.81	153.6
	6-Sep-2016	7.20	4,040	19.50	2.53	NM
2-Jun-2016	7.09	3,542	17.60	2.87	66.2	
25-Feb-2016	7.12	3,494	17.20	1.47	167.5	
23-Nov-2015	7.29	3,106	19.79	1.71	29.8	
1-Sep-2015	7.52	2,935	22.60	NM	101.4	

**TABLE 2. SUMMARY OF MONITORING WELL GROUNDWATER FIELD PARAMETERS
DONA ANA DAIRIES, DONA ANA COUNTY, NEW MEXICO**

Monitoring Well	Date Measured	pH	SpC (uS/cm)	Temp (°C)	DO (mg/L)	ORP (mV)
DAD-06	13-Sep-2022	Dry Since Septemeber 2022				
	27-May-2022	Dry				
	22-Mar-2022	Dry				
	1-Dec-2021	Dry				
	31-Aug-2021	Dry				
	4-Jun-2021	Dry				
	3-Mar-2021	Dry				
	1-Dec-2020	Dry				
	31-Aug-2020	Dry				
	1-Jun-2020	Dry				
	9-Mar-2020	Dry				
	4-Dec-2019	Dry				
	22-Aug-2019	Dry				
	28-May-2019	Dry				
	14-Mar-2019	Dry				
	4-Dec-2018	Dry				
	31-Aug-2018	Dry				
	4-Jun-2018	Dry				
	28-Feb-2018	Dry				
	28-Nov-2017	Dry				
	29-Aug-2017	Dry				
	12-Jun-2017	Dry				
	13-Mar-2017	Dry				
	6-Dec-2016	Dry				
	8-Sep-2016	Dry				
	6-Jun-2016	Dry				
	25-Feb-2016	Dry				
23-Nov-2015	Dry					
1-Sep-2015	Dry					

**TABLE 2. SUMMARY OF MONITORING WELL GROUNDWATER FIELD PARAMETERS
DONA ANA DAIRIES, DONA ANA COUNTY, NEW MEXICO**

Monitoring Well	Date Measured	pH	SpC (uS/cm)	Temp (°C)	DO (mg/L)	ORP (mV)
DAD-06R	30-May-2023	7.23	1,315	27.0	1.25	79
	7-Mar-2023	7.26	1,052	23.2	1.10	131
	6-Dec-2022	7.46	1,108	23.8	0.75	140
DAD-07	5-Jun-2023	7.28	3,698	25.6	2.61	124
	7-Mar-2023	7.27	3,312	24.2	2.19	123
	7-Dec-2022	7.22	3,138	24.1	2.14	168
	13-Sep-2022	7.20	2,906	25.0	2.02	126
	1-Jun-2022	7.22	2,976	24.5	2.05	184
	22-Mar-2022	7.26	3,086	22.0	2.16	163
	7-Dec-2021	7.28	3,213	24.0	2.25	115
	1-Sep-2021	7.20	5,616	25.2	2.44	120
	4-Jun-2021	7.28	3,539	24.9	2.56	172
	3-Mar-2021	7.31	3,596	24.1	2.76	123
	4-Dec-2020	7.18	3,634	22.8	2.88	203
	3-Sep-2020	7.31	3,773	24.8	2.82	171
	3-Jun-2020	7.50	3,471	25.6	2.63	140
	25-Feb-2020	6.93	3,220	23.0	0.50	181
	5-Dec-2019	6.41	3,142	23.2	1.91	136
	21-Aug-2019	6.84	3,261	25.6	3.19	224
	24-May-2019	6.51	3,153	24.4	2.44	308
	8-Mar-2019	6.71	2,534	24.1	1.34	162
	29-Nov-2018	6.86	3,070	23.9	1.64	148
	27-Aug-2018	6.93	3,138	24.9	2.20	236
	1-Jun-2018	6.75	3,341	25.3	3.11	151
	27-Feb-2018	6.64	3,823	24.2	3.61	156
	28-Nov-2017	7.02	3,636	24.4	4.16	149
	28-Aug-2017	6.86	3,270	24.7	NM	190
	6-Jun-2017	6.73	3,048	24.96	2.80	196.7
	10-Mar-2017	6.92	2,948	24.40	3.24	196.4
	5-Dec-2016	6.93	2,847	23.78	5.11	215.0
7-Sep-2016	7.12	3,160	24.80	5.78	NM	
8-Jun-2016	6.79	2,985	24.84	4.60	239.2	
1-Mar-2016	7.00	3,037	24.36	4.23	208.7	
30-Nov-2015	7.09	3,088	21.59	4.65	257.1	
1-Sep-2015	7.37	3,569	26.31	NM	148.2	

**TABLE 2. SUMMARY OF MONITORING WELL GROUNDWATER FIELD PARAMETERS
DONA ANA DAIRIES, DONA ANA COUNTY, NEW MEXICO**

Monitoring Well	Date Measured	pH	SpC (uS/cm)	Temp (°C)	DO (mg/L)	ORP (mV)
DAD-08	5-Jun-2023	7.24	6,590	22.4	2.22	140
	8-Mar-2023	7.38	6,558	21.7	2.92	86
	8-Dec-2022	7.37	6,354	21.5	2.95	135
	12-Sep-2022	7.30	6,947	22.7	2.85	62
	31-May-2022	7.41	7,122	22.5	2.97	116
	18-Mar-2022	7.20	6,936	20.6	2.51	189
	6-Dec-2021	7.49	6,815	21.2	2.75	68
	2-Sep-2021	7.46	6,947	22.8	2.94	208
	7-Jun-2021	7.67	7,471	22.4	2.71	104
	3-Mar-2021	7.68	7,165	21.3	2.00	103
	3-Dec-2020	7.25	6,949	20.8	2.90	182
	2-Sep-2020	7.43	7,396	22.8	2.51	131
	2-Jun-2020	7.18	7,059	23.9	2.48	184
	21-Feb-2020	7.36	7,094	20.4	0.44	81
	4-Dec-2019	6.57	7,007	20.3	6.32	167
	19-Aug-2019	6.98	7,181	22.1	2.93	72
	23-May-2019	6.38	7,905	21.9	2.21	288
	5-Mar-2019	7.25	3,765	20.6	1.84	158
	29-Nov-2018	7.50	6,136	20.8	2.11	159
	24-Aug-2018	6.99	7,829	22.1	3.11	128
	31-May-2018	6.73	7,682	21.1	3.52	109
	26-Feb-2018	6.97	7,135	21.1	3.24	126
	27-Nov-2017	7.27	6,587	21.2	2.87	149
	25-Aug-2017	7.07	6,396	21.9	3.05	243
	8-Jun-2017	6.50	7,029	21.64	3.83	59.4
	7-Mar-2017	7.34	7,737	20.57	2.34	237.7
	2-Dec-2016	7.02	8,153	20.74	4.32	138.9
	6-Sep-2016	7.28	8,410	21.80	4.98	NM
	2-Jun-2016	7.06	7,862	21.51	4.97	78.8
	25-Feb-2016	7.07	7,896	20.38	4.79	177.3
23-Nov-2015	7.20	8,036	26.21	3.73	95.1	
1-Sep-2015	7.54	8,449	23.03	NM	181.8	
DAD-09	6-Jun-2023	7.23	2,964	23.9	2.06	150
	9-Mar-2023	7.39	3,083	22.5	2.19	126
	9-Dec-2022	7.29	3,043	22.6	2.23	147
	13-Sep-2022	7.22	3,020	24.0	2.28	116
	1-Jun-2022	7.20	3,058	24.1	2.30	211
	22-Mar-2022	7.63	2,881	22.0	1.81	159
	7-Dec-2021	7.66	1,938	22.4	887.2	108
	3-Sep-2021	7.58	1,143	24.6	1.81	220
	28-May-2021	7.50	2,988	24.0	2.43	165
	8-Mar-2021	7.38	2,954	21.9	2.33	148
	7-Dec-2020	7.49	2,834	21.8	2.51	181
	3-Sep-2020	7.52	2,205	26.3	1.06	157
	3-Jun-2020	7.41	3,651	24.4	2.53	170
	19-Feb-2020	7.13	2,836	22.1	2.03	171
	6-Dec-2019	6.82	1,262	22.4	1.69	255
	21-Aug-2019	6.84	4,602	23.8	3.43	122
	24-May-2019	6.15	4,669	23.5	1.71	282
	7-Mar-2019	6.91	2,609	23.0	1.56	137
	30-Nov-2018	6.80	3,429	22.0	1.34	151
	27-Aug-2018	6.06	4,046	24.1	1.59	217
	4-Jun-2018	6.23	4,601	22.7	1.34	160
	28-Feb-2018	6.61	3,836	22.2	1.67	183
	28-Nov-2017	6.98	3,372	23.0	2.77	193
	23-Aug-2017	6.92	3,070	23.8	4.98	129
	9-Jun-2017	6.57	3,975	23.74	2.73	65.9
	10-Mar-2017	6.72	3,865	22.49	1.01	197.9
	6-Dec-2016	7.20	3,618	21.40	3.70	326.0
	7-Sep-2016	6.93	3,430	24.40	2.41	NM
	6-Jun-2016	6.64	3,142	23.46	2.49	271.9
	29-Feb-2016	6.90	2,888	22.47	2.55	216.2
23-Nov-2015	7.01	2,837	21.88	2.08	127.2	
2-Sep-2015	7.19	3,006	24.32	NM	243.3	

**TABLE 2. SUMMARY OF MONITORING WELL GROUNDWATER FIELD PARAMETERS
DONA ANA DAIRIES, DONA ANA COUNTY, NEW MEXICO**

Monitoring Well	Date Measured	pH	SpC (uS/cm)	Temp (°C)	DO (mg/L)	ORP (mV)
DAD-10	9-Jun-2023	7.22	2,151	21.8	1.60	136
	10-Mar-2023	7.37	2,165	21.0	1.61	234
	9-Dec-2022	7.29	2,193	18.5	1.63	179
	14-Sep-2022	7.23	2,143	22.6	1.59	113
	2-Jun-2022	7.43	2,154	21.9	1.59	198
	23-Mar-2022	7.50	2,162	18.7	1.66	191
	8-Dec-2021	7.43	2,174	20.6	1.63	169
	24-Aug-2021	7.80	2,153	23.3	1.57	99
	28-May-2021	7.15	2,167	21.2	1.73	153
	8-Mar-2021	7.73	2,117	21.2	1.59	164
	24-Nov-2020	7.87	2,127	20.5	1.59	149
	3-Sep-2020	7.58	2,192	22.9	1.57	197
	4-Jun-2020	7.29	2,197	22.0	1.63	254
	19-Feb-2020	7.52	2,444	19.0	2.13	175
	2-Dec-2019	6.79	2,077	19.8	1.85	151
	22-Aug-2019	7.18	2,209	21.3	1.86	196
	24-May-2019	6.71	2,160	21.6	2.36	302
	11-Mar-2019	7.34	2,180	20.8	1.09	154
	30-Nov-2018	6.87	2,318	19.8	1.61	175
	27-Aug-2018	7.24	2,206	22.1	1.31	229
	4-Jun-2018	6.72	2,294	20.8	3.39	138
	28-Feb-2018	7.03	2,415	20.7	3.88	167
	28-Nov-2017	7.35	2,497	21.9	2.77	166
	25-Aug-2017	7.08	2,544	22.5	3.14	197
	9-Jun-2017	6.59	2,411	21.96	4.55	222.6
	8-Mar-2017	7.28	2,414	21.94	2.21	213.2
	6-Dec-2016	7.52	2,404	19.76	2.85	260.7
	7-Sep-2016	7.47	2,620	22.70	2.81	NM
6-Jun-2016	7.07	2,301	22.38	2.17	269.5	
29-Feb-2016	7.28	2,364	21.64	3.63	229.0	
24-Nov-2015	7.37	2,259	21.32	2.13	81.6	
3-Sep-2015	7.27	2,421	22.08	NM	241.2	

**TABLE 2. SUMMARY OF MONITORING WELL GROUNDWATER FIELD PARAMETERS
DONA ANA DAIRIES, DONA ANA COUNTY, NEW MEXICO**

Monitoring Well	Date Measured	pH	SpC (uS/cm)	Temp (°C)	DO (mg/L)	ORP (mV)
DAD-11 Vertical Delineation	25-May-2023	7.22	4,778	22.1	1.63	131
	3-Mar-2023	7.22	4,619	19.6	2.72	134
	2-Dec-2022	7.25	4,388	21.3	2.43	157
	25-Aug-2022	7.30	4,339	22.6	1.34	120
	25-May-2022	7.20	4,306	21.1	2.87	208
	15-Mar-2022	7.19	4,333	20.7	2.90	153
	30-Nov-2021	7.60	4,320	22.9	2.88	159
	25-Aug-2021	7.74	4,263	25.2	2.60	201
	1-Jun-2021	7.78	4,292	22.5	2.59	148
	1-Mar-2021	7.68	4,058	21.0	2.93	129
	1-Dec-2020	7.18	4,015	20.2	1.52	168
	28-Aug-2020	7.78	4,212	22.5	1.88	-113
	29-May-2020	7.45	4,231	21.8	2.93	148
	26-Feb-2020	7.67	3,989	20.0	0.47	131
	12-Dec-2019	6.59	3,885	21.0	3.05	255
	20-Aug-2019	7.00	4,409	22.4	2.10	129
	28-May-2019	6.69	4,318	21.5	1.44	291
	11-Mar-2019	7.22	3,059	21.4	1.80	171
	3-Dec-2018	6.76	4,309	21.6	1.80	164
	29-Aug-2018	7.07	4,476	23.1	1.75	265
	31-May-2018	6.59	4,493	23.6	3.41	128
	28-Feb-2018	7.59	3,902	23.0	3.28	151
	29-Nov-2017	7.50	2,972	22.5	3.77	180
	29-Aug-2017	7.04	3,868	21.6	1.68	245
	6-Jun-2017	6.62	4,544	22.51	1.94	197.6
	8-Mar-2017	7.11	5,351	22.03	2.60	227.8
	2-Dec-2016	7.26	4,183	22.13	1.53	126.7
	8-Sep-2016	7.18	6,250	22.40	2.26	NM
	8-Jun-2016	6.60	5,892	22.05	1.24	248.7
	29-Feb-2016	7.19	4,518	20.64	5.13	367.9
24-Nov-2015	7.22	6,105	22.14	1.25	151.2	
1-Sep-2015	6.94	4,712	23.60	NM	246.7	
DAD-12 Vertical Delineation	25-May-2023	7.24	4,656	22.6	2.33	148
	2-Mar-2023	7.24	4,711	19.5	2.90	179
	1-Dec-2022	7.28	4,869	21.3	2.33	155
	25-Aug-2022	7.25	4,861	22.8	1.88	178
	24-May-2022	7.25	4,961	22.0	2.48	252
	3-Mar-2022	7.30	4,962	22.0	2.91	198
	23-Nov-2021	7.20	5,149	21.3	2.47	143
	25-Aug-2021	7.32	5,436	22.4	2.26	171
	1-Jun-2021	7.28	5,446	22.1	2.85	179
	26-Feb-2021	7.74	5,256	20.8	2.15	140
	30-Nov-2020	7.28	5,275	21.0	2.05	150
	27-Aug-2020	7.77	5,466	25.5	2.31	197
	29-May-2020	7.43	5,572	23.3	2.63	165
	26-Feb-2020	7.35	5,306	21.0	0.22	156
	3-Dec-2019	6.55	5,258	20.4	2.80	163
	20-Aug-2019	6.80	5,755	22.8	1.30	198
	28-May-2019	6.24	5,551	22.7	3.20	256
	11-Mar-2019	7.02	3,117	21.5	2.21	168
	3-Dec-2018	6.58	4,898	22.0	2.35	163
	28-Aug-2018	6.93	5,561	22.8	2.03	211
	1-Jun-2018	6.70	5,726	22.9	4.62	148
	27-Feb-2018	7.07	5,851	23.0	5.17	131
	29-Nov-2017	7.07	5,856	22.3	3.03	172
	28-Aug-2017	6.92	5,429	22.6	3.67	191
	12-Jun-2017	7.17	4,221	22.69	3.62	192.5
	8-Mar-2017	6.90	5,893	22.19	1.77	207.6
	5-Dec-2016	6.94	5,930	23.21	0.75	182.5
	8-Sep-2016	7.20	4,610	22.10	1.69	NM
	8-Jun-2016	6.79	4,216	22.18	1.64	249.1
	29-Feb-2016	6.97	4,222	21.11	1.84	257.0
24-Nov-2015	7.20	4,205	22.34	1.67	106.3	

**TABLE 2. SUMMARY OF MONITORING WELL GROUNDWATER FIELD PARAMETERS
DONA ANA DAIRIES, DONA ANA COUNTY, NEW MEXICO**

Monitoring Well	Date Measured	pH	SpC (uS/cm)	Temp (°C)	DO (mg/L)	ORP (mV)
DAD-13	25-May-2023	7.42	3,550	25.4	2.81	127
	2-Mar-2023	7.22	3,684	21.8	2.72	131
	2-Dec-2022	7.18	3,747	22.3	2.82	187
	25-Aug-2022	7.21	3,756	24.0	2.82	137
	24-May-2022	7.31	3,656	23.7	2.75	168
	3-Mar-2022	7.25	3,880	23.6	2.93	146
	23-Nov-2021	7.36	3,524	23.1	2.65	149
	25-Aug-2021	7.45	3,333	24.5	2.47	173
	1-Sep-2015	6.99	4,285	22.76	NM	261.4
	1-Jun-2021	7.29	3,303	24.6	2.46	151
	1-Mar-2021	7.20	3,200	22.2	2.46	222
	30-Nov-2020	7.05	2,978	21.7	2.32	167
	28-Aug-2020	7.48	3,538	24.4	2.73	219
	29-May-2020	7.50	3,540	25.0	2.61	125
	26-Feb-2020	7.55	3,100	22.7	0.50	128
	3-Dec-2019	6.48	2,966	20.8	4.82	183
	20-Aug-2019	6.86	3,547	24.5	1.91	148
	23-May-2019	6.54	3,281	23.8	1.28	302
	8-Mar-2019	6.73	2,580	22.2	1.68	168
	28-Nov-2018	7.22	3,061	22.8	2.29	149
	27-Aug-2018	6.89	2,838	23.7	2.06	278
	31-May-2018	6.50	4,023	22.7	1.77	132
	27-Feb-2018	6.99	2,522	22.2	3.11	121
	27-Nov-2017	7.00	2,726	23.0	2.24	197
	24-Aug-2017	6.77	3,593	23.4	3.06	236
	12-Jun-2017	7.37	3,773	23.87	4.76	120.9
	8-Mar-2017	6.86	3,350	23.15	1.95	209.7
	5-Dec-2016	7.09	3,429	20.09	5.61	421.1
	8-Sep-2016	6.88	3,620	24.20	2.80	NM
	2-Jun-2016	6.77	3,443	23.46	2.60	88.0
25-Feb-2016	6.91	3,407	22.77	1.49	210.9	
DAD-14	26-May-2023	7.28	5,906	21.8	2.94	149
	2-Mar-2023	7.29	5,574	19.7	2.72	207
	2-Dec-2022	7.32	5,226	21.4	2.04	161
	26-Aug-2022	7.24	4,378	22.2	1.88	134
	24-May-2022	7.33	4,185	21.6	2.33	168
	15-Mar-2022	7.60	4,159	21.2	NM	NM
	23-Nov-2021	7.68	4,185	21.4	2.79	149
	26-Aug-2021	7.58	4,295	22.7	2.60	142
	24-Nov-2015	7.01	3,306	22.97	1.54	126.5
	1-Sep-2015	7.31	3,595	24.61	NM	226.0
	3-Jun-2021	7.23	4,231	21.2	2.78	223
	2-Mar-2021	7.79	4,158	20.6	2.33	100
	1-Dec-2020	7.43	4,184	20.7	1.33	155
	28-Aug-2020	7.40	4,530	23.8	2.08	62
	29-May-2020	7.32	4,565	22.9	2.43	127
	26-Feb-2020	7.55	4,463	20.5	0.42	109
	3-Dec-2019	6.86	4,601	20.6	2.60	176
	20-Aug-2019	7.24	4,907	22.3	1.24	159
	24-May-2019	6.76	4,954	21.1	2.88	304
	8-Mar-2019	7.14	3,439	21.1	1.70	162
	28-Nov-2018	7.35	5,061	20.7	2.58	165
	29-Aug-2018	7.36	5,042	21.3	2.27	173
	31-May-2018	7.05	5,198	20.6	2.12	136
	26-Feb-2018	7.59	5,296	20.8	4.07	153
	27-Nov-2017	7.49	5,366	21.4	2.19	183
	28-Aug-2017	7.31	5,459	21.8	4.52	215
	6-Jun-2017	6.61	5,433	21.54	2.11	117.6
	8-Mar-2017	7.45	5,547	20.79	2.59	199.2
	2-Dec-2016	7.34	5,493	20.33	1.77	137.5
	8-Sep-2016	7.45	5,850	21.60	2.81	NM
2-Jun-2016	7.20	5,487	20.75	4.09	85.4	
29-Feb-2016	7.47	5,231	20.00	2.60	265.3	

**TABLE 2. SUMMARY OF MONITORING WELL GROUNDWATER FIELD PARAMETERS
DONA ANA DAIRIES, DONA ANA COUNTY, NEW MEXICO**

Monitoring Well	Date Measured	pH	SpC (uS/cm)	Temp (°C)	DO (mg/L)	ORP (mV)
DAD-15	30-May-2023	7.31	3,488	25.3	2.68	140
	6-Mar-2023	7.22	3,838	24.1	2.86	128
	5-Dec-2022	7.27	3,808	23.8	2.70	140
	31-Aug-2022	7.23	3,756	24.1	2.91	76
	26-May-2022	7.28	3,920	24.6	2.49	194
	23-Mar-2022	7.27	3,779	23.4	2.78	187
	2-Dec-2021	7.60	3,712	22.8	2.71	49
	31-Aug-2021	7.23	3,565	26.2	2.49	182
	24-Nov-2015	7.56	5,242	21.02	2.60	139.1
	1-Sep-2015	7.42	5,006	21.43	NM	247.2
	4-Jun-2021	7.68	3,274	23.7	2.34	80
	4-Mar-2021	7.62	3,360	23.3	2.34	198
	4-Dec-2020	7.34	3,354	23.2	2.53	261
	3-Sep-2020	7.30	3,294	24.7	2.60	186
	1-Jun-2020	7.34	3,226	24.8	2.45	117
	26-Feb-2020	7.44	3,030	23.9	0.93	115
	5-Dec-2019	6.72	3,019	22.0	1.36	187
	21-Aug-2019	6.80	3,390	25.0	4.24	214
	24-May-2019	6.60	3,291	23.4	2.28	275
	8-Mar-2019	7.09	2,723	23.4	1.04	149
	30-Nov-2018	7.07	2,820	22.0	2.21	176
	27-Aug-2018	6.94	3,139	25.5	2.44	245
	1-Jun-2018	6.85	3,070	24.1	2.25	148
	27-Feb-2018	7.32	3,015	22.1	2.81	113
	20-Nov-2017	7.11	2,906	23.9	3.36	129
	28-Aug-2017	7.03	2,890	24.3	2.72	167
	9-Jun-2017	6.85	2,869	24.42	3.63	23.7
	13-Mar-2017	6.99	2,829	22.47	3.01	236.5
	5-Dec-2016	7.06	2,831	22.56	5.56	186.2
	7-Sep-2016	7.64	2,830	24.10	4.73	NM
8-Jun-2016	6.96	2,762	25.21	2.12	223.8	
29-Feb-2016	7.07	2,738	22.66	4.68	251.2	
DAD-16	30-May-2023	7.21	2,806	20.7	2.09	149
	6-Mar-2023	7.34	2,970	19.2	2.22	208
	6-Dec-2022	7.36	2,833	19.3	2.16	172
	31-Aug-2022	7.29	3,235	19.9	2.41	90
	26-May-2022	7.33	3,466	19.5	2.59	175
	16-Mar-2022	7.47	3,326	18.5	2.55	157
	1-Dec-2021	7.84	3,338	18.5	2.55	106
	31-Aug-2021	7.58	3,454	20.1	2.63	126
	24-Nov-2015	7.22	2,630	22.17	3.36	171.1
	3-Sep-2015	7.14	2,702	23.39	NM	240.8
	4-Jun-2021	7.70	3,508	18.1	2.67	163
	3-Mar-2021	7.40	3,139	18.9	2.42	133
	2-Dec-2020	7.70	3,310	17.4	2.59	146
	31-Aug-2020	7.40	3,494	20.1	2.61	97
	1-Jun-2020	7.18	3,313	20.5	2.35	115
	25-Feb-2020	7.34	2,946	17.5	0.19	99
	5-Dec-2019	7.04	3,197	18.7	2.36	150
	20-Aug-2019	7.28	3,297	19.6	0.92	164
	23-May-2019	6.70	3,048	18.3	1.88	255
	8-Mar-2019	7.23	2,760	18.5	1.59	155
	29-Nov-2018	7.28	3,446	18.6	1.30	173
	27-Aug-2018	7.21	3,611	19.8	3.17	237
	1-Jun-2018	7.06	3,721	18.4	2.30	156
	27-Feb-2018	7.36	2,897	20.0	1.96	134
	28-Nov-2017	7.70	3,501	19.3	3.21	88
	28-Aug-2017	7.20	4,416	20.0	3.82	184
	6-Jun-2017	6.67	3,672	18.94	2.86	187.6
	8-Mar-2017	7.43	3,679	19.15	2.27	218.1
	2-Dec-2016	7.42	2,551	19.22	2.29	145.9
	7-Sep-2016	7.36	4,590	19.70	2.40	NM
6-Jun-2016	6.99	2,448	18.73	2.45	229.3	
29-Feb-2016	7.33	3,106	18.49	2.60	204.9	

**TABLE 2. SUMMARY OF MONITORING WELL GROUNDWATER FIELD PARAMETERS
DONA ANA DAIRIES, DONA ANA COUNTY, NEW MEXICO**

Monitoring Well	Date Measured	pH	SpC (uS/cm)	Temp (°C)	DO (mg/L)	ORP (mV)
DAD-17	1-Jun-2023	7.25	1,528	20.7	1.10	105
	8-Mar-2023	7.19	1,513	19.8	1.06	137
	8-Dec-2022	7.25	1,474	20.0	1.05	190
	1-Sep-2022	7.32	1,346	20.8	0.98	71
	31-May-2022	7.25	1,450	20.5	1.05	172
	17-Mar-2022	7.41	1,345	20.1	1.16	154
	6-Dec-2021	7.18	1,232	19.7	1.05	168
	2-Sep-2021	7.20	1,941	22.2	1.06	102
	30-Nov-2015	7.34	3,424	18.55	2.81	229.8
	2-Sep-2015	7.35	2,861	20.26	NM	251.4
	7-Jun-2021	7.77	1,510	20.9	1.07	93
	4-Mar-2021	7.75	988.7	19.7	1.05	128
	2-Dec-2020	7.74	919.0	20.1	1.12	156
	2-Sep-2020	7.29	1,711	22.2	1.09	238
	2-Jun-2020	7.30	1,207	20.3	1.11	200
	25-Feb-2020	7.55	1,121	17.8	0.73	145
	5-Dec-2019	7.09	856.9	21.5	5.21	162
	21-Aug-2019	7.40	1,196	20.5	2.29	180
	23-May-2019	7.01	971.4	19.9	2.38	264
	8-Mar-2019	7.37	1,031	19.4	1.17	138
	29-Nov-2018	6.88	918.1	20.6	1.06	127
	24-Aug-2018	7.40	880.4	21.6	3.70	98
	31-May-2018	7.39	935.7	19.7	2.66	56
	27-Feb-2018	7.48	863.4	20.3	2.04	113
	28-Nov-2017	7.71	992.4	21.8	3.51	105
	25-Aug-2017	7.58	1,146	21.0	2.58	185
	7-Jun-2007	7.15	1,051	20.05	2.27	82.6
	13-Mar-2017	7.41	1,145	15.36	2.18	226.5
	5-Dec-2016	7.42	1,225	20.94	1.09	173.9
	8-Sep-2016	7.40	1,640	20.80	1.68	NM
6-Jun-2016	6.90	1,729	19.60	1.72	270.2	
1-Mar-2016	7.56	1,550	19.74	1.54	216.9	
DAD-18 Vertical Delineation	5-Jun-2023	7.27	4,110	18.5	2.46	146
	8-Mar-2023	7.27	4,197	18.4	2.30	93
	8-Dec-2022	7.29	4,171	18.0	2.48	100
	12-Sep-2022	7.20	4,051	18.2	1.11	94
	31-May-2022	7.28	3,973	18.5	2.39	84
	18-Mar-2022	7.23	3,896	17.1	2.99	185
	6-Dec-2021	7.72	3,919	17.6	2.84	63
	2-Sep-2021	7.41	4,016	19.4	2.37	140
	30-Nov-2015	7.46	1,621	19.06	2.78	226.0
	2-Sep-2015	7.35	2,099	20.55	NM	252.1
	7-Jun-2021	7.32	4,121	20.0	1.93	232
	4-Mar-2021	7.86	4,111	17.7	2.21	151
	3-Dec-2020	7.21	4,082	18.0	2.41	181
	2-Sep-2020	7.41	4,258	19.6	1.74	182
	2-Jun-2020	7.44	4,289	20.4	2.96	187
	25-Feb-2020	7.68	4,070	17.3	1.01	189
	5-Dec-2019	6.74	3,955	18.2	3.58	173
	20-Aug-2019	6.95	4,150	18.8	1.53	157
	28-May-2019	6.61	3,984	18.8	2.08	293
	11-Mar-2019	6.74	2,771	18.0	1.66	177
	29-Nov-2018	7.78	4,066	18.5	1.59	152
	28-Aug-2018	6.91	4,090	19.2	2.46	213
	4-Jun-2018	6.44	4,253	19.0	2.49	150
	28-Feb-2018	6.94	4,289	18.2	2.64	170
	29-Nov-2017	7.31	4,233	17.9	3.03	202
	29-Aug-2017	6.91	4,326	19.2	2.21	260
	12-Jun-2017	7.20	3,957	19.58	4.32	72.8
	8-Mar-2017	7.19	4,011	18.81	1.41	232.4
	5-Dec-2016	7.14	3,914	18.32	2.52	191.4
	9-Sep-2016	7.17	4,290	20.70	1.62	NM
6-Jun-2016	6.95	3,722	19.15	4.73	273.2	
1-Mar-2016	7.40	3,852	18.76	4.26	329.2	

**TABLE 2. SUMMARY OF MONITORING WELL GROUNDWATER FIELD PARAMETERS
DONA ANA DAIRIES, DONA ANA COUNTY, NEW MEXICO**

Monitoring Well	Date Measured	pH	SpC (uS/cm)	Temp (°C)	DO (mg/L)	ORP (mV)
DAD-19 Vertical Delineation	1-Jun-2023	7.20	4,744	22.3	1.84	156
	7-Mar-2023	7.26	4,752	22.0	2.65	151
	7-Dec-2022	7.28	4,708	20.8	2.80	174
	1-Sep-2022	7.21	4,708	22.5	2.66	116
	27-May-2022	7.24	4,655	23.1	1.55	203
	17-Mar-2022	7.20	4,570	21.7	2.66	188
	2-Dec-2021	7.53	4,603	23.8	2.67	170
	1-Sep-2021	7.68	4,673	24.1	2.59	167
	30-Nov-2015	7.23	3,781	18.11	2.89	239.5
	2-Sep-2015	7.24	4,009	19.26	NM	252.9
	4-Jun-2021	7.51	4,389	22.1	2.94	200
	3-Mar-2021	7.53	4,229	24.3	2.40	129
	4-Dec-2020	7.17	4,463	22.1	2.19	271
	3-Sep-2020	7.62	4,546	22.8	1.33	256
	2-Jun-2020	7.62	4,591	23.6	4.42	187
	25-Feb-2020	7.36	4,395	18.6	0.60	108
	4-Dec-2019	6.98	4,506	20.1	3.98	112
	20-Aug-2019	6.77	4,907	23.0	1.64	129
	28-May-2019	6.23	4,731	23.3	1.33	274
	11-Mar-2019	6.78	2,565	21.1	1.28	179
	30-Nov-2018	6.71	4,376	21.8	1.88	191
	28-Aug-2018	7.00	4,489	22.5	1.94	186
	4-Jun-2018	6.36	4,800	23.0	2.06	112
	28-Feb-2018	6.71	4,742	21.5	2.85	155
	29-Nov-2017	6.90	4,728	21.7	3.08	192
	29-Aug-2017	6.83	4,634	22.4	2.02	225
	12-Jun-2017	7.19	4,383	22.64	4.21	-29.7
	13-Mar-2017	6.92	4,644	21.94	1.82	320.8
	6-Dec-2016	7.34	4,573	22.75	1.80	213.7
	9-Sep-2016	7.08	4,610	23.60	1.84	NM
8-Jun-2016	6.75	4,410	22.74	1.85	247.1	
1-Mar-2016	7.10	4,729	21.91	1.98	290.9	
DAD-20	9-Jun-2023	7.23	4,076	22.7	1.22	131
	10-Mar-2023	7.25	3,620	22.3	1.39	146
	12-Dec-2022	7.31	3,478	21.7	2.71	207
	14-Sep-2022	7.20	3,555	23.1	2.95	115
	2-Jun-2022	7.28	4,104	23.3	1.55	207
	23-Mar-2022	7.29	4,107	21.7	2.78	195
	8-Dec-2021	7.28	3,960	22.0	2.30	169
	7-Sep-2021	7.47	3,863	22.8	2.34	142
	30-Nov-2015	7.13	4,730	21.08	3.07	248.2
	2-Sep-2015	7.09	4,900	24.03	NM	238.0
	28-May-2021	7.58	3,954	24.1	2.90	101
	8-Mar-2021	7.87	3,808	22.7	2.82	107
	7-Dec-2020	7.53	3,895	21.5	2.90	208
	8-Sep-2020	7.40	4,452	24.2	1.79	229
	4-Jun-2020	7.11	4,211	24.6	2.39	295
	19-Feb-2020	7.39	3,626	21.8	1.95	151
	2-Dec-2019	6.78	3,752	22.0	2.02	141
	21-Aug-2019	7.03	3,721	23.3	5.51	113
	28-May-2019	6.60	3,838	22.5	1.24	285
	7-Mar-2019	7.11	2,571	22.1	1.20	143
	30-Nov-2018	7.11	3,569	20.2	1.04	174
	28-Aug-2018	7.08	3,829	23.4	1.28	235
	1-Jun-2018	6.79	3,904	23.2	1.62	145
	28-Feb-2018	7.05	3,888	21.7	1.36	186
	28-Nov-2017	7.33	3,726	22.5	5.04	198
	24-Aug-2017	7.14	3,711	23.3	4.53	63
	7-Jun-2017	6.92	3,446	22.41	2.76	175.9
	10-Mar-2017	7.24	3,557	22.46	2.75	235.1
	5-Dec-2016	7.19	3,719	22.19	6.05	176.2
	7-Sep-2016	7.46	3,880	23.40	6.29	NM
6-Jun-2016	7.02	3,499	22.51	5.70	271.7	
1-Mar-2016	7.42	3,517	21.55	5.29	308.0	

**TABLE 2. SUMMARY OF MONITORING WELL GROUNDWATER FIELD PARAMETERS
DONA ANA DAIRIES, DONA ANA COUNTY, NEW MEXICO**

Monitoring Well	Date Measured	pH	SpC (uS/cm)	Temp (°C)	DO (mg/L)	ORP (mV)
DAD-21	6-Jun-2023	7.19	4,305	22.8	2.79	141
	9-Mar-2023	7.30	3,787	22.2	2.48	105
	9-Dec-2022	7.20	3,501	21.1	2.58	175
	13-Sep-2022	7.22	3,851	22.6	2.83	132
	1-Jun-2022	7.18	4,350	23.3	2.35	170
	22-Mar-2022	7.40	4,255	21.1	2.33	180
	7-Dec-2021	7.30	4,303	22.1	2.43	111
	3-Sep-2021	7.18	4,587	23.1	2.85	160
	28-May-2021	7.31	5,019	22.3	2.98	120
	8-Mar-2021	7.15	4,798	21.6	2.90	251
	7-Dec-2020	7.19	4,736	20.8	2.94	218
	3-Sep-2020	7.40	5,055	24.3	1.77	185
	3-Jun-2020	7.38	5,089	23.4	2.36	179
	19-Feb-2020	7.12	4,493	20.3	2.64	162
	6-Dec-2019	6.42	4,622	21.5	2.43	188
	21-Aug-2019	6.92	4,608	23.4	2.80	141
	24-May-2019	6.34	4,382	22.4	1.30	284
	7-Mar-2019	6.84	2,700	21.4	1.20	144
	30-Nov-2018	7.07	3,601	20.4	1.53	148
	27-Aug-2018	6.77	4,447	23.3	1.74	216
	4-Jun-2018	6.45	4,615	21.8	2.42	164
	28-Feb-2018	7.04	4,649	19.9	2.21	191
	28-Nov-2017	7.09	4,340	21.8	2.68	192
	23-Aug-2017	6.87	3,914	23.4	3.37	150
	9-Jun-2017	6.65	3,822	22.21	2.96	133.2
	10-Mar-2017	6.97	4,354	20.41	2.52	191.6
	6-Dec-2016	7.33	3,969	19.88	6.24	489.8
	7-Sep-2016	6.94	4,920	22.90	2.70	NM
6-Jun-2016	6.66	3,931	22.03	3.98	271.5	
29-Feb-2016	7.00	3,327	21.97	3.68	227.5	
DAD-22	6-Jun-2023	7.24	3,700	23.9	2.60	133
	9-Mar-2023	7.62	3,690	23.3	2.80	168
	9-Dec-2022	7.35	3,697	22.2	2.84	143
	14-Sep-2022	7.19	3,694	23.0	2.86	144
	2-Jun-2022	7.17	3,692	23.2	2.84	193
	23-Mar-2022	7.14	3,708	22.4	2.83	196
	8-Dec-2021	7.17	3,712	22.0	2.86	165
	3-Sep-2021	7.54	3,673	25.5	2.11	155
	23-Nov-2015	7.17	3,174	21.19	4.52	122.1
	2-Sep-2015	7.17	3,349	23.03	NM	225.0
	28-May-2021	7.51	3,694	24.2	2.80	142
	8-Mar-2021	7.49	3,621	23.6	2.75	153
	7-Dec-2020	7.52	3,608	21.9	2.80	214
	8-Sep-2020	7.30	5,963	23.1	1.58	204
	3-Jun-2020	7.34	3,810	24.6	2.83	184
	19-Feb-2020	7.54	3,581	22.6	2.14	137
	6-Dec-2019	7.11	3,432	22.1	4.25	137
	21-Aug-2019	7.27	3,752	25.2	2.98	179
	24-May-2019	6.54	3,012	24.1	1.87	274
	7-Mar-2019	7.18	2,879	23.4	2.20	137
	30-Nov-2018	7.64	2,839	21.1	1.98	149
	24-Aug-2018	7.43	3,692	24.7	2.84	133
	1-Jun-2018	7.37	3,831	25.9	1.88	137
	27-Feb-2018	7.31	3,856	22.9	1.70	150
	28-Nov-2017	7.91	3,847	23.6	3.84	191
	23-Aug-2017	7.26	3,812	25.5	3.24	141
	7-Jun-2017	7.12	4,114	27.32	4.63	91.5
	7-Mar-2017	7.70	3,915	22.36	2.29	202.1
	5-Dec-2016	7.36	3,808	22.17	4.75	170.5
	6-Sep-2016	7.68	4,060	2.39	3.72	NM
	8-Jun-2016	6.98	3,907	24.86	4.36	230.3
	25-Feb-2016	7.12	3,802	22.15	3.71	192.0

**TABLE 2. SUMMARY OF MONITORING WELL GROUNDWATER FIELD PARAMETERS
DONA ANA DAIRIES, DONA ANA COUNTY, NEW MEXICO**

Monitoring Well	Date Measured	pH	SpC (uS/cm)	Temp (°C)	DO (mg/L)	ORP (mV)
DAD-23	26-May-2023	7.22	3,760	23.3	2.53	148
	3-Mar-2023	7.24	3,105	21.0	1.74	151
	5-Dec-2022	7.23	3,425	22.7	2.26	177
	26-Aug-2022	7.28	2,607	23.4	1.83	77
	25-May-2022	7.30	3,473	23.2	1.79	188
	15-Mar-2022	7.52	3,691	22.2	1.98	138
	1-Dec-2021	7.20	3,175	21.9	1.80	172
	26-Aug-2021	7.88	3,510	23.6	1.71	106
	23-Nov-2015	7.28	2,913	22.16	3.95	126.0
	2-Sep-2015	7.65	4,065	25.17	NM	207.8
	3-Jun-2021	7.37	3,377	23.0	1.58	141
	2-Mar-2021	7.90	3,336	22.4	1.67	122
	1-Dec-2020	7.68	2,113	22.2	1.60	144
	28-Aug-2020	7.57	2,081	24.8	1.54	62
	1-Jun-2020	7.34	2,386	22.6	1.75	161
	26-Feb-2020	7.62	2,043	21.4	0.61	119
	6-Dec-2019	7.34	2,911	21.4	3.70	165
	19-Aug-2019	7.45	2,614	24.2	2.91	103
	24-May-2019	7.03	2,511	22.9	2.71	293
	8-Mar-2019	7.42	2,973	22.5	1.23	164
	28-Nov-2018	7.93	3,168	21.9	1.79	146
	27-Aug-2018	7.54	2,388	23.8	1.23	248
	31-May-2018	7.04	3,050	23.4	3.04	118
	26-Feb-2018	7.82	3,046	22.0	2.21	144
	29-Nov-2017	7.66	3,178	22.6	2.88	179
	24-Aug-2017	7.37	3,565	23.4	2.59	209
7-Jun-2017	7.29	3,380	23.87	4.96	64.9	
7-Mar-2017	7.55	3,433	21.99	2.54	181.5	
5-Dec-2016	7.65	2,354	22.16	2.64	197.4	
7-Sep-2016	7.40	3,580	23.10	2.52	NM	
DAD-24 Vertical Delineation	1-Jun-2023	7.21	4,327	24.4	2.30	156
	7-Mar-2023	7.25	4,255	22.9	2.87	130
	7-Dec-2022	7.29	4,233	21.7	2.80	195
	1-Sep-2022	7.23	4,180	23.8	1.93	134
	27-May-2022	7.29	4,135	24.5	1.36	167
	17-Mar-2022	7.24	4,044	22.1	2.63	194
	2-Dec-2021	7.25	4,054	21.8	1.27	116
	1-Sep-2021	7.23	4,050	23.1	2.93	142
	2-Jun-2016	7.54	2,308	23.32	1.64	62.0
	29-Feb-2016	7.60	2,402	22.54	1.10	126.8
	4-Jun-2021	7.12	4,060	22.4	1.29	178
	3-Mar-2021	7.40	4,011	22.3	2.54	116
	4-Dec-2020	7.09	3,944	22.2	1.01	217
	2-Sep-2020	7.74	4,135	24.8	2.09	188
	2-Jun-2020	7.63	4,205	24.3	2.89	191
	25-Feb-2020	7.00	3,770	20.3	0.39	114
	4-Dec-2019	6.47	3,881	21.5	4.21	96
	20-Aug-2019	6.58	4,077	23.4	1.89	114
	28-May-2019	6.42	3,978	22.7	1.71	275
	11-Mar-2019	6.80	2,533	21.2	1.44	153
	30-Nov-2018	6.70	3,797	21.4	1.30	175
	31-Aug-2018	6.60	3,978	22.5	1.29	118
	4-Jun-2018	6.32	4,011	24.3	3.56	106
	28-Feb-2018	6.66	4,091	21.6	3.31	179
	29-Nov-2017	6.64	4,114	21.5	3.11	175
	29-Aug-2007	6.61	4,199	22.7	1.60	224
12-Jun-2017	6.92	4,221	24.28	2.78	226.3	
13-Mar-2017	6.70	4,248	22.44	1.35	220.8	
6-Dec-2016	7.00	4,221	23.71	0.30	-261.3	
9-Sep-2016	7.13	2,860	23.20	1.28	NM	

**TABLE 2. SUMMARY OF MONITORING WELL GROUNDWATER FIELD PARAMETERS
DONA ANA DAIRIES, DONA ANA COUNTY, NEW MEXICO**

Monitoring Well	Date Measured	pH	SpC (uS/cm)	Temp (°C)	DO (mg/L)	ORP (mV)
DAD-25	5-Jun-2023	7.25	3,328	23.5	2.83	130
	9-Mar-2023	7.23	3,051	22.2	2.21	133
	8-Dec-2022	7.41	3,012	22.6	2.23	110
	12-Sep-2022	7.31	2,889	23.8	2.09	72
	1-Jun-2022	7.25	2,251	22.4	1.72	190
	18-Mar-2022	7.61	1,297	22.4	1.02	163
	7-Dec-2021	7.76	1,467	21.2	1.13	101
	3-Sep-2021	7.45	1,221	24.1	1.00	94
	8-Jun-2016	6.97	2,634	22.98	1.86	244.7
	1-Mar-2016	7.20	2,507	22.26	1.89	237.4
	7-Jun-2021	7.19	3,460	23.9	2.84	204
	4-Mar-2021	7.66	3,289	22.1	2.52	132
	3-Dec-2020	7.57	3,204	20.8	2.54	208
	2-Sep-2020	7.33	3,150	25.0	2.32	208
	2-Jun-2020	7.10	3,119	24.8	2.42	165
	26-Feb-2020	7.55	2,840	21.4	0.87	105
	6-Dec-2019	6.67	2,755	20.9	1.84	231
	22-Aug-2019	7.15	2,712	25.0	3.42	262
	28-May-2019	6.79	2,547	22.3	2.47	296
	11-Mar-2019	7.09	2,207	21.3	2.17	142
	29-Nov-2018	7.34	2,521	21.7	1.93	127
	28-Aug-2018	7.53	2,425	22.9	2.41	189
	4-Jun-2018	6.87	2,393	22.5	3.17	125
	27-Feb-2018	7.09	2,300	22.9	3.28	146
	27-Nov-2017	7.51	2,256	22.3	3.29	157
	25-Aug-2017	7.12	2,706	23.0	3.64	232
	8-Jun-2017	6.73	2,663	23.04	4.82	54.7
10-Mar-2017	7.12	4,093	22.57	3.34	247.5	
2-Dec-2016	6.98	4,949	21.57	3.02	131.3	
8-Sep-2016	7.17	5,560	23.10	3.32	NM	

**TABLE 2. SUMMARY OF MONITORING WELL GROUNDWATER FIELD PARAMETERS
DONA ANA DAIRIES, DONA ANA COUNTY, NEW MEXICO**

Monitoring Well	Date Measured	pH	SpC (uS/cm)	Temp (°C)	DO (mg/L)	ORP (mV)
DAD-26	6-Jun-2023	7.19	3,286	23.7	2.53	133
	10-Mar-2023	7.25	3,440	22.6	2.70	140
	12-Dec-2022	7.27	2,982	22.0	2.21	174
	14-Sep-2022	7.24	3,067	23.4	2.34	124
	2-Jun-2022	7.24	3,000	23.3	2.24	205
	23-Mar-2022	7.25	2,906	22.3	2.19	193
	8-Dec-2021	7.11	2,587	22.3	1.95	156
	7-Sep-2021	7.18	2,918	23.7	2.14	115
	6-Jun-2016	6.79	3,918	22.59	3.04	268.3
	1-Mar-2016	7.11	5,434	22.49	2.12	297.6
	28-May-2021	7.75	3,390	24.3	2.54	132
	8-Mar-2021	7.59	3,733	23.0	2.90	128
	7-Dec-2020	7.23	3,040	21.8	2.32	245
	8-Sep-2020	7.39	3,558	23.8	2.56	197
	3-Jun-2020	7.75	3,725	23.8	2.79	174
	19-Feb-2020	7.49	2,189	23.0	2.00	191
	6-Dec-2019	7.13	1,659	23.7	4.13	158
	21-Aug-2019	6.92	3,715	24.3	1.17	210
	28-May-2019	6.37	3,735	22.7	2.60	285
	7-Mar-2019	6.71	2,631	22.5	1.44	155
	30-Nov-2018	7.02	3,233	18.3	1.17	160
	28-Aug-2018	7.30	4,386	23.4	1.16	224
	4-Jun-2018	6.31	4,516	22.9	2.84	161
	28-Feb-2018	6.72	4,910	22.1	3.37	187
	28-Nov-2017	6.97	5,006	22.7	2.93	200
	28-Aug-2017	6.71	5,160	23.0	3.12	205
	9-Jun-2017	6.59	5,039	23.4	3.02	37.3
	10-Mar-2017	6.81	5,283	22.37	2.65	310.3
6-Dec-2016	7.25	5,006	21.07	3.01	285.3	
8-Sep-2016	7.16	4,880	23.60	2.40	NM	
6-Jun-2016	6.70	4,273	23.39	1.77	270.3	
1-Mar-2016	7.30	3,959	21.09	1.36	245.7	
DAD-27	6-Jun-2023	7.22	3,065	22.4	2.23	138
	10-Mar-2023	7.18	2,818	21.4	2.15	141
	12-Dec-2022	7.18	3,013	21.3	2.35	182

Notes:

* = Monitoring well contains a pump; as a result, DO and ORP values are not representative of aquifer conditions.

°C = Degrees Celsius

DO = Dissolved oxygen

mg/L = Milligrams per liter

mV = Millivolts

NM = Not measured

NS = Not sampled

ORP = Oxidation-reduction potential

SpC = Specific conductance

Temp = Temperature

uS/cm = Microsiemens per centimeter

Data from current quarter.

Red text indicates suspect result.

**TABLE 3. SUMMARY OF SAMPLE ANALYTICAL METHODS AND SAMPLING REQUIREMENTS
DONA ANA DAIRIES, DONA ANA COUNTY, NEW MEXICO**

Target Analytes	Analytical Method	Sample Container	Preservative	Holding Time
Nitrate as N	EPA 300.0	500 mL HDPE	Cool to <6°C	48 hours
Nitrate + Nitrite as N	EPA 300.0	500 mL HDPE	H ₂ SO ₄ to pH <2, Cool to <6°C	28 days
Total Kjeldhal Nitrogen	SM 4500 NORG C	500 mL HDPE	H ₂ SO ₄ to pH <2, Cool to <6°C	28 days
Chloride	EPA 300.0	500 mL HDPE	Cool to <6°C	28 days
Total Dissolved Solids	SM 2540 C MOD	500 mL HDPE	Cool to <6°C	7 days

Notes:

°C = Degrees Celsius

EPA = U.S. Environmental Protection Agency

H₂SO₄ = Sulfuric acid

HDPE = High-density polyethylene

mL = milliliter

MOD = Modified

N = Nitrogen

SM = Standard method

**TABLE 4. ABATEMENT PLAN MONITORING WELL GROUNDWATER ANALYTICAL RESULTS
DONA ANA DAIRIES, DONA ANA COUNTY, NEW MEXICO**

Monitoring Well	Date Sampled	Nitrate (mg/l)	TKN (mg/l)	Chloride (mg/l)	TDS (mg/l)	Sulfate (mg/l)
Abatement Plan Monitoring Wells						
Northern Portion						
DAD-01	25-May-23	13	<2.0	370	1,460	NA
	2-Mar-23	16	<2.0	470	1,690	NA
	1-Dec-22	12	<2.0	420	1,520	NA
	24-Aug-22	10	<2.0	360	1,520	NA
	24-May-22	16	<2.0	370	1,530	NA
	3-Mar-22	20	<5.0	420	1,750	NA
	23-Nov-21	18	<2.0	380	819	NA
	25-Aug-21	20	<5.0	350	1,520	NA
	1-Jun-21	19	<2.0	340	1,510	NA
	1-Mar-21	18	<2.0	410	1,660	NA
	30-Nov-20	16	<2.0	430	1,640	NA
	27-Aug-20	16	<2.0	310	1,390	NA
	29-May-20	15	<5.0	310	1,420	NA
	21-Feb-20	13	<1.0	420	1,740	NA
	3-Dec-19	12	<2.0	360	1,500	NA
	19-Aug-19	12	<2.0	290	1,520	NA
	22-May-19	13	<2.0	300	1,420	NA
	5-Mar-19	11	<2.0	350	1,690	NA
	28-Nov-18	12	<2.0	320	1,430	NA
	24-Aug-18	15	<2.0	280	1,350	NA
	31-May-18	15	<2.0	250	1,310	NA
	26-Feb-18	9.5	<1.0	350	1,520	NA
	20-Nov-17	9.46	<0.300	400	1,500	NA
	24-Aug-17	10.4	<0.0500	396	1,560	NA
	8-Jun-17	17.0	<0.100	354	1,600	NA
	7-Mar-17	7.90	<0.300	438	1,620	NA
	30-Nov-16	5.19	<0.300	482	1,690	NA
	6-Sep-16	5.35	<0.937	502	1,580	NA
	2-Jun-16	3.27	<2.24	457	1,730	NA
	25-Feb-16	2.70	7.28	512	1,770	NA
	23-Nov-15	4.17	<1.18	491	1,680	NA
	1-Sep-15	8.52	2.10	420	1,600	NA
	27-May-15	10.9	<1.18	418	1,640	NA
	4-Mar-15	4.70	<1.80	459	1,910	NA
	3-Dec-14	6.53	<1.80	468	1,780	NA
	29-Aug-14	8.28	<1.80	425	1,830	NA
	3-Jun-14	6.13	<1.80	491	2,020	NA
	10-Mar-14	5.76	<1.66	496	1,780	NA
	11-Dec-13	7.61	3.50	471	1,760	NA
	10-Sep-13	4.43	2.80	472	1,920	NA
16-May-13	10.4	<1.66	408	1,930	NA	
28-Feb-13	10.0	<1.72	469	1,740	NA	
3-Dec-12	10.7	<1.72	348	1,800	NA	
21-Aug-12	9.98	<1.72	373	1,640	NA	
9-May-12	6.88	2.80	401	1,660	NA	
31-Jan-12	9.90	2.52	439	1,520	NA	
27-Oct-11	9.56	3.50	436	1,840	256	
20-Jul-11	12.0	2.38	426	1,650	NA	
20-Apr-11	10.3	<2.17	460	1,710	NA	
24-Jan-11	19.8	3.50	408	1,820	NA	
16-Sep-10	7.56	<10.0	439	1,800	NA	
29-Jun-10	8.55	<1.0	491	2,120	NA	
21-Mar-10	6.3	<5.0	500	1,780	NA	
9-Dec-09	7.5	1.5	550	2,010	NA	
NMED Split	9-Dec-09	7.3	2.8	468	356	264
	29-Aug-09	7.3	<5.0	540	1,970	NA
	12-May-09	5.6	<1.0	540	1,800	NA

**TABLE 4. ABATEMENT PLAN MONITORING WELL GROUNDWATER ANALYTICAL RESULTS
DONA ANA DAIRIES, DONA ANA COUNTY, NEW MEXICO**

Monitoring Well	Date Sampled	Nitrate (mg/l)	TKN (mg/l)	Chloride (mg/l)	TDS (mg/l)	Sulfate (mg/l)
DAD-02	26-May-23	8.4	<2.0	460	1,610	NA
	3-Mar-23	9.2	<1.0	400	1,480	NA
	5-Dec-22	8.7	<1.0	380	1,560	NA
	26-Aug-22	9.6	<1.0	350	1,540	NA
	25-May-22	9.5	<1.0	310	1,280	NA
	16-Mar-22	8.8	<1.0	300	1,230	NA
	30-Nov-21	9.0	<1.0	270	1,140	NA
	26-Aug-21	8.8	<1.0	250	1,090	NA
	3-Jun-21	8.7	<1.0	230	1,070	NA
	2-Mar-21	9.4	<1.0	240	1,110	NA
	1-Dec-20	9.0	<1.0	250	1,090	NA
	28-Aug-20	8.1	<1.0	250	1,110	NA
	29-May-20	8.5	<2.0	230	1,070	NA
	21-Feb-20	8.9	<1.0	250	1,240	NA
	4-Dec-19	8.9	<2.0	260	1,180	NA
	19-Aug-19	8.3	<1.0	270	1,140	NA
	22-May-19	7.8	<1.0	280	1,220	NA
	5-Mar-19	7.6	<1.0	290	1,350	NA
	28-Nov-18	10	<2.0	350	1,410	NA
	24-Aug-18	11	<2.0	390	1,440	NA
	31-May-18	9.4	<1.0	430	1,570	NA
	26-Feb-18	10	<2.0	490	1,640	NA
	20-Nov-17	11.7	<0.300	534	1,500	NA
	24-Aug-17	11.4	<0.0500	479	1,580	NA
	8-Jun-17	11.3	<0.100	473	1,570	NA
	7-Mar-17	11.5	<0.300	522	1,650	NA
	30-Nov-16	10.1	<0.300	506	1,610	NA
	6-Sep-16	9.10	<0.937	500	1,460	NA
	2-Jun-16	9.45	<2.24	467	1,470	NA
	25-Feb-16	10.7	5.60	520	1,480	NA
	23-Nov-15	10.3	<1.18	493	1,600	NA
	31-Aug-15	10.3	3.50	511	1,760	NA
	27-May-15	10.6	<1.18	465	1,540	NA
	4-Mar-15	9.15	<1.80	440	1,560	NA
	3-Dec-14	8.47	<1.80	542	1,710	NA
	29-Aug-14	7.05	<1.80	451	1,690	NA
	3-Jun-14	5.18	<1.80	506	1,640	NA
	10-Mar-14	7.75	<1.66	463	1,620	NA
	11-Dec-13	7.91	2.80	443	1,540	NA
	9-Sep-13	7.14	<1.66	337	1,900	NA
16-May-13	9.19	<1.66	393	1,750	NA	
1-Mar-13	8.52	<1.72	357	1,520	NA	
3-Dec-12	8.51	<1.72	345	1,800	NA	
21-Aug-12	4.39	2.10	301	1,570	NA	
9-May-12	7.71	<1.72	373	1,830	NA	
31-Jan-12	7.66	<2.17	335	1,720	NA	
27-Oct-11	8.30	2.52	380	1,360	475	
20-Jul-11	7.66	<2.17	374	1,750	NA	
21-Apr-11	7.97	<2.17	434	1,760	NA	
24-Jan-11	6.38	2.80	443	2,240	NA	
16-Sep-10	3.44	<10.0	385	1,790	NA	
29-Jun-10	8.11	<0.5	364	1,870	NA	
21-Mar-10	8.1	<1.0	420	1,970	NA	
9-Dec-09	9.0	<1.0	440	1,920	NA	
NMED Split	9-Dec-09	9	0.39	388	1,970	586
	29-Aug-09	9.9	<2.0	490	1,890	NA
	14-May-09	7.4	<5.0	350	1,700	NA

**TABLE 4. ABATEMENT PLAN MONITORING WELL GROUNDWATER ANALYTICAL RESULTS
DONA ANA DAIRIES, DONA ANA COUNTY, NEW MEXICO**

Monitoring Well	Date Sampled	Nitrate (mg/l)	TKN (mg/l)	Chloride (mg/l)	TDS (mg/l)	Sulfate (mg/l)
DAD-11 Vertical Delineation (formerly 177-03)	25-May-23	17	<2.0	730	3,100	NA
	3-Mar-23	13	<1.0	770	2,970	NA
	2-Dec-22	11	<2.0	590	2,860	NA
	25-Aug-22	12	<2.0	640	2,820	NA
	25-May-22	12	<2.0	680	2,830	NA
	15-Mar-22	11	<2.0	640	2,850	NA
	30-Nov-21	12	<2.0	640	2,780	NA
	25-Aug-21	12	<2.0	650	2,790	NA
	1-Jun-21	12	2.5	640	2,810	NA
	1-Mar-21	13	<2.0	620	2,730	NA
	1-Dec-20	13	<2.0	630	2,700	NA
	28-Aug-20	11	<2.0	610	2,670	NA
	26-Feb-20	12	<2.0	670	2,690	NA
	12-Dec-19	13	<2.0	610	2,670	NA
	20-Aug-19	13	<2.0	690	2,820	NA
	28-May-19	13	<2.0	690	2,840	NA
	11-Mar-19	13	<2.0	670	2,740	NA
	3-Dec-18	13	<2.0	710	2,840	NA
	29-Aug-18	16	<2.0	730	2,960	NA
	31-May-18	14	<2.0	690	2,930	NA
	26-Feb-18	10	<2.0	590	2,450	NA
	29-Nov-17	3.80	<0.0500	447	1,660	NA
	29-Aug-17	11.5	<0.0500	550	2,350	NA
	6-Jun-17	12.3	0.564	821	3,030	NA
	8-Mar-17	14.0	0.627	983	3,420	NA
	5-Dec-16	7.40	<0.300	691	2,680	NA
	8-Sep-16	15.4	<0.937	1,200	3,960	NA
	8-Jun-16	14.3	<2.24	1,060	4,040	NA
	29-Feb-16	13.5	<1.18	1,060	3,040	NA
	24-Nov-15	17.1	8.40	1,320	4,030	NA
	1-Sep-15	12.4	<1.18	981	3,120	NA
	29-May-15	13.9	<1.18	990	3,070	NA
	5-Mar-15	19.7	<1.80	1,220	3,960	NA
	5-Dec-14	19.9	<1.80	1,230	3,870	NA
	3-Sep-14	11.1	<1.80	717	2,950	NA
	6-Jun-14	1.31	4.90	477	1,860	NA
	17-Mar-14	12.0	<1.66	890	3,230	NA
	16-Dec-13	15.0	2.10	1,170	3,790	NA
	9-Sep-13	13.6	2.80	1,080	3,560	NA
	29-May-13	15.7	<1.66	1,110	3,600	NA
1-Mar-13	14.6	<1.72	1,190	3,600	NA	
3-Dec-12	13.4	<1.72	1,210	3,870	NA	
21-Aug-12	8.71	<1.72	818	3,020	NA	
14-May-12	0.791	<1.72	359	1,550	NA	
1-Feb-12	2.38	<2.17	456	1,700	NA	
27-Oct-11	<0.500	<2.17	434	1,290	215	
2-Aug-11	<0.500	<2.17	427	1,490	NA	
5-May-11	<0.500	<2.17	398	1,360	NA	
25-Jan-11	4.60	<2.05	386	1,500	NA	
21-Sep-10	3.21	<10.0	369	1,520	NA	
29-Jun-10	1.6	<1.0	430	1,610	NA	
28-Apr-10	1.5	<1.0	450	1,600	NA	
20-Jan-10	1.4	<1.0	460	1,600	NA	
21-Oct-09	1.0	<1.0	430	1,600	NA	
7-Jul-09	0.80	<1.0	470	1,500	NA	
6-May-09	0.97	3.5	450	1,600	NA	
22-Jan-09	1.00	<1.0	370	1,600	NA	

**TABLE 4. ABATEMENT PLAN MONITORING WELL GROUNDWATER ANALYTICAL RESULTS
DONA ANA DAIRIES, DONA ANA COUNTY, NEW MEXICO**

Monitoring Well	Date Sampled	Nitrate (mg/l)	TKN (mg/l)	Chloride (mg/l)	TDS (mg/l)	Sulfate (mg/l)
DAD-12 Vertical Delineation	25-May-23	10	<2.0	720	2,980	NA
	2-Mar-23	11	<2.0	810	3,120	NA
	1-Dec-22	11	<2.0	930	3,210	NA
	25-Aug-22	11	<2.0	800	3,200	NA
	24-May-22	11	<2.0	900	3,230	NA
	3-Mar-22	12	<2.0	950	3,240	NA
	23-Nov-21	12	<2.0	870	3,420	NA
	25-Aug-21	13	<2.0	1,100	3,550	NA
	1-Jun-21	12	<2.0	1,100	3,550	NA
	1-Mar-21	13	<2.0	1,100	3,520	NA
	30-Nov-20	14	<2.0	1,200	3,590	NA
	27-Aug-20	13	2.5	1,100	3,510	NA
	29-May-20	15	1.1	1,100	3,590	NA
	26-Feb-20	15	<2.0	1,200	3,660	NA
	3-Dec-19	20	<5.0	480	1,960	NA
	20-Aug-19	15	<2.0	1,200	3,700	NA
	28-May-19	15	<2.0	1,200	3,690	NA
	11-Mar-19	18	<2.0	1,100	3,630	NA
	3-Dec-18	17	<2.0	1,100	3,650	NA
	28-Aug-18	20	<2.0	1,100	3,710	NA
	1-Jun-18	21	<5.0	1,200	3,740	NA
	27-Feb-18	21	<5.0	1,200	3,820	NA
	29-Nov-17	19.3	<0.0500	1,200	3,430	NA
	28-Aug-17	25.6	<0.0500	1,070	3,580	NA
	12-Jun-17	21.0	<0.100	975	3,330	NA
	8-Mar-17	25.7	<0.0501	1,200	3,690	NA
	5-Dec-16	20.7	<0.300	1,180	3,760	NA
	8-Sep-16	19.2	<0.937	805	2,960	NA
	8-Jun-16	18.2	<2.24	889	2,900	NA
	29-Feb-16	20.7	<1.18	809	2,980	NA
	24-Nov-15	19.8	<1.18	735	2,860	NA
	1-Sep-15	19.8	<1.18	759	2,950	NA
	29-May-15	14.6	<1.18	705	2,860	NA
	6-Mar-15	19.0	<1.80	625	2,860	NA
	4-Dec-14	19.0	<1.80	620	2,760	NA
	3-Sep-14	18.6	<1.80	588	2,700	NA
	9-Jun-14	19.3	<1.80	603	2,750	NA
	17-Mar-14	20.5	<1.66	621	2,890	NA
	13-Dec-13	18.5	2.10	638	2,840	NA
	10-Sep-13	18.1	2.80	557	2,950	NA
29-May-13	18.2	<1.66	686	3,130	NA	
28-Feb-13	22.8	<1.72	688	2,820	NA	
3-Dec-12	16.4	<1.72	689	3,070	NA	
21-Aug-12	17.8	2.10	620	2,990	NA	
14-May-12	23.1	<1.72	561	2,870	NA	
1-Feb-12	20.8	<2.17	614	2,670	NA	
7-Dec-11	18.8	<2.17	597	2,620	616	

**TABLE 4. ABATEMENT PLAN MONITORING WELL GROUNDWATER ANALYTICAL RESULTS
DONA ANA DAIRIES, DONA ANA COUNTY, NEW MEXICO**

Monitoring Well	Date Sampled	Nitrate (mg/l)	TKN (mg/l)	Chloride (mg/l)	TDS (mg/l)	Sulfate (mg/l)
DAD-13	25-May-23	11	<2.0	570	2,230	NA
	2-Mar-23	12	<2.0	690	2,330	NA
	2-Dec-22	12	<2.0	630	2,390	NA
	25-Aug-22	6.8	<1.0	660	2,380	NA
	24-May-22	13	<2.0	580	2,250	NA
	3-Mar-22	9.0	<1.0	740	2,500	NA
	23-Nov-21	8.3	<1.0	550	2,240	NA
	25-Aug-21	8.1	<1.0	520	2,180	NA
	1-Jun-21	11	<2.0	500	2,110	NA
	1-Mar-21	15	<2.0	530	2,110	NA
	30-Nov-20	17	<2.0	460	1,920	NA
	28-Aug-20	13	<2.0	600	2,210	NA
	29-May-20	13	<2.0	550	2,130	NA
	26-Feb-20	14	<2.0	580	1,960	NA
	3-Dec-19	16	<2.0	1,100	3,640	NA
	20-Aug-19	11	<2.0	640	2,170	NA
	24-May-19	12	<2.0	590	2,130	NA
	8-Mar-19	10	<1.0	570	2,000	NA
	28-Nov-18	6.6	<1.0	470	1,910	NA
	27-Aug-18	12	<2.0	450	1,800	NA
	31-May-18	16	<2.0	710	2,550	NA
	27-Feb-18	27	<5.0	360	1,740	NA
	27-Nov-17	21.5	<0.0500	418	1,850	NA
	24-Aug-17	16.0	<0.0500	619	2,280	NA
	12-Jun-17	16.0	<0.100	701	2,520	NA
	8-Mar-17	14.0	<0.0501	523	2,020	NA
	5-Dec-16	9.54	<0.300	622	2,240	NA
	8-Sep-16	10.9	<0.937	673	2,300	NA
	2-Jun-16	10.5	<2.24	676	2,310	NA
	25-Feb-16	11.0	<1.18	702	2,200	NA
	24-Nov-15	9.98	<1.18	642	2,280	NA
	1-Sep-15	9.82	<1.18	611	2,300	NA
	29-May-15	11.8	<1.18	666	2,280	NA
	6-Mar-15	6.72	<1.80	553	2,120	NA
	4-Dec-14	9.14	<1.80	581	2,160	NA
	2-Sep-14	6.51	<1.80	386	1,960	NA
	9-Jun-14	5.82	<1.80	507	2,000	NA
	17-Mar-14	6.59	<3.32	528	1,960	NA
	13-Dec-13	5.83	<1.66	546	1,940	NA
	9-Sep-13	3.42	2.80	524	1,800	NA
29-May-13	5.00	<1.66	550	2,020	NA	
28-Feb-13	5.63	<1.72	582	1,970	NA	
3-Dec-12	5.04	<1.72	504	1,810	NA	
21-Aug-12	3.51	<1.72	420	1,900	NA	
10-May-12	8.66	<1.72	514	2,010	NA	
1-Feb-12	7.59	<2.17	537	1,960	NA	
27-Oct-11	7.51	2.52	536	3,700	321	

**TABLE 4. ABATEMENT PLAN MONITORING WELL GROUNDWATER ANALYTICAL RESULTS
DONA ANA DAIRIES, DONA ANA COUNTY, NEW MEXICO**

Monitoring Well	Date Sampled	Nitrate (mg/l)	TKN (mg/l)	Chloride (mg/l)	TDS (mg/l)	Sulfate (mg/l)
DAD-14	26-May-23	60	<5.0	1,200	3,830	NA
	2-Mar-23	45	<5.0	1,100	3,490	NA
	2-Dec-22	36	<5.0	930	2,310	NA
	26-Aug-22	22	<5.0	690	2,850	NA
	24-May-22	18	<2.0	610	2,750	NA
	15-Mar-22	17	<2.0	620	2,670	NA
	23-Nov-21	17	<2.0	590	2,830	NA
	26-Aug-21	16	2.8	630	2,600	NA
	3-Jun-21	15	<2.0	640	2,720	NA
	2-Mar-21	17	<2.0	660	2,640	NA
	1-Dec-20	17	<2.0	660	2,770	NA
	28-Aug-20	18	<2.0	690	2,880	NA
	29-May-20	19	<2.0	720	2,980	NA
	26-Feb-20	20	<2.0	820	3,020	NA
	3-Dec-19	20	<5.0	730	3,060	NA
	20-Aug-19	21	<5.0	820	3,140	NA
	24-May-19	22	<5.0	860	3,260	NA
	8-Mar-19	22	<5.0	830	3,310	NA
	28-Nov-18	21	<5.0	840	3,240	NA
	29-Aug-18	22	<5.0	890	3,180	NA
	31-May-18	21	<5.0	860	3,350	NA
	26-Feb-18	24	<5.0	910	3,210	NA
	27-Nov-17	25.5	0.494	1,010	3,270	NA
	28-Aug-17	28.5	<0.0500	1,010	3,170	NA
	6-Jun-17	32.7	<0.0500	1,060	3,750	NA
	8-Mar-17	39.1	0.0694	1,090	3,780	NA
	2-Dec-16	39.0	<0.300	1,140	3,750	NA
	8-Sep-16	44.5	<0.937	1,170	3,700	NA
	2-Jun-16	40.9	<2.24	1,280	3,700	NA
	29-Feb-16	40.2	<1.18	1,280	3,540	NA
	24-Nov-15	33.9	<1.18	1,220	3,550	NA
	1-Sep-15	32.1	<1.18	1,110	3,260	NA
	29-May-15	32.7	<1.18	1,030	3,320	NA
	5-Mar-15	30.2	<1.80	949	3,280	NA
	4-Dec-14	30.3	<1.80	933	3,200	NA
	2-Sep-14	26.7	2.10	878	3,240	NA
	6-Jun-14	29.6	<1.80	943	3,340	NA
	17-Mar-14	41.3	<1.66	1,040	3,620	NA
	13-Dec-13	31.9	<1.66	929	3,160	NA
	9-Sep-13	29.2	3.50	1,010	3,590	NA
29-May-13	34.6	<1.66	1,030	3,520	NA	
1-Mar-13	42.0	16.8	1,130	3,730	NA	
3-Dec-12	40.3	<1.72	1,150	4,010	NA	
21-Aug-12	33.2	<1.72	919	3,340	NA	
14-May-12	28.8	<1.72	881	3,280	NA	
1-Feb-12	20.3	<2.17	861	2,880	NA	
27-Oct-11	17.2	2.80	835	1,780	447	

**TABLE 4. ABATEMENT PLAN MONITORING WELL GROUNDWATER ANALYTICAL RESULTS
DONA ANA DAIRIES, DONA ANA COUNTY, NEW MEXICO**

Monitoring Well	Date Sampled	Nitrate (mg/l)	TKN (mg/l)	Chloride (mg/l)	TDS (mg/l)	Sulfate (mg/l)
DAD-23	26-May-23	18	<2.0	370	1,730	NA
	3-Mar-23	20	1.40	550	2,070	NA
	5-Dec-22	18	<2.0	420	2,030	NA
	26-Aug-22	19	<2.0	320	1,620	NA
	25-May-22	19	<2.0	400	1,700	NA
	15-Mar-22	15	<2.0	620	2,550	NA
	1-Dec-21	16	<2.0	640	2,670	NA
	26-Aug-21	15	<2.0	300	1,420	NA
	3-Jun-21	15	<2.0	540	2,320	NA
	2-Mar-21	15	<2.0	460	2,310	NA
	1-Dec-20	20	<2.0	480	1,890	NA
	28-Aug-20	19	<2.0	280	1,440	NA
	1-Jun-20	21	150	520	1,960	NA
	26-Feb-20	22	<5.0	350	1,570	NA
	6-Dec-19	18	<2.0	540	2,410	NA
	19-Aug-19	17	<2.0	540	2,220	NA
	24-May-19	19	<2.0	390	1,960	NA
	8-Mar-19	17	<2.0	540	2,260	NA
	28-Nov-18	18	<2.0	500	2,090	NA
	27-Aug-18	21	<2.0	580	2,350	NA
	31-May-18	19	<2.0	670	2,500	NA
	26-Feb-18	16	<2.0	490	1,890	NA
	29-Nov-17	18.2	<0.0500	763	2,050	NA
	24-Aug-17	19.5	<0.0500	676	2,500	NA
	7-Jun-17	14.9	<0.100	580	2,300	NA
	7-Mar-17	12.0	<0.300	577	2,230	NA
5-Dec-16	5.57	<0.300	566	1,940	NA	
7-Sep-16	1.86	<0.937	462	1,720	NA	
2-Jun-16	1.10	<2.24	636	2,260	NA	
29-Feb-16	<0.305	<1.18	421	1,680	NA	
21-Dec-15	6.11	<1.18	450	1,860	NA	
NMWQCC Standard		10	NA	250	1,000	600
Existing Conditions - August 2020		NA	NA	1,800	1,598	NA
Existing Conditions - Pre-August 2020*		NA	NA	1,015	3,178	NA

**TABLE 4. ABATEMENT PLAN MONITORING WELL GROUNDWATER ANALYTICAL RESULTS
DONA ANA DAIRIES, DONA ANA COUNTY, NEW MEXICO**

Monitoring Well	Date Sampled	Nitrate (mg/l)	TKN (mg/l)	Chloride (mg/l)	TDS (mg/l)	Sulfate (mg/l)
Central Portion						
DAD-03	26-May-23	<1.0	<1.0	310	1,770	NA
	6-Mar-23	<1.0	<1.0	360	1,780	NA
	5-Dec-22	<1.0	<1.0	290	1,610	NA
	26-Aug-22	<1.0	<1.0	350	1,700	NA
	26-May-22	<1.0	<2.0	330	2,330	NA
	16-Mar-22	<1.0	<1.0	330	2,070	NA
	1-Dec-21	<1.0	<1.0	340	2,070	NA
	26-Aug-21	<1.0	2.8	410	1,980	NA
	3-Jun-21	<1.0	<1.0	310	1,660	NA
	2-Mar-21	<1.0	<2.0	290	1,560	NA
	1-Dec-20	<1.0	<1.0	270	1,530	NA
	31-Aug-20	<1.0	<1.0	300	1,620	NA
	1-Jun-20	<1.0	4.5	300	1,530	NA
	21-Feb-20	<1.0	<5.0	300	2,090	NA
	4-Dec-19	<1.0	<2.0	320	1,880	NA
	19-Aug-19	<1.0	2.5	330	2,140	NA
	22-May-19	<1.0	3.6	390	2,050	NA
	5-Mar-19	<1.0	3.1	330	2,180	NA
	28-Nov-18	<1.0	2.5	320	2,110	NA
	24-Aug-18	<1.0	<2.0	350	2,520	NA
	31-May-18	<1.0	<5.0	370	1,930	NA
	26-Feb-18	<1.0	<2.0	360	2,220	NA
	20-Nov-17	0.2220	0.498	446	2,060	NA
	24-Aug-17	0.0823	<0.0500	440	2,240	NA
	8-Jun-17	0.150	2.67	454	2,110	NA
	7-Mar-17	0.251	3.09	589	2,570	NA
	30-Nov-16	0.874	4.29	647	2,820	NA
	6-Sep-16	<0.305	<0.937	289	2,520	NA
	2-Jun-16	<0.305	<2.24	540	2,410	NA
	25-Feb-16	<0.305	3.92	558	2,340	NA
	23-Nov-15	<0.194	<1.18	603	2,440	NA
	1-Sep-15	<0.194	1.40	702	2,720	NA
	27-May-15	<0.0470	<1.18	738	2,620	NA
	4-Mar-15	<0.0470	<1.80	609	2,630	NA
	3-Dec-14	<0.126	<1.80	569	2,560	NA
	29-Aug-14	<0.126	<1.80	686	2,890	NA
	9-Jun-14	<0.187	<1.80	838	3,410	NA
	10-Mar-14	0.906	<1.66	917	3,480	NA
	11-Dec-13	<0.213	<1.66	932	3,180	NA
	10-Sep-13	Not Sampled - insufficient water to sample				
16-May-13	1.07	<1.66	1,400	4,420	NA	
1-Mar-13	0.721	<1.72	1,220	3,720	NA	
3-Dec-12	1.1	<1.72	1,150	4,760	NA	
21-Aug-12	<0.0290	2.80	1,090	3,920	NA	
9-May-12	<0.114	2.66	1,200	4,160	NA	
31-Jan-12	<0.500	4.34	1,340	4,350	NA	
26-Oct-11	<0.500	3.22	1,790	5,420	1,100	
20-Jul-11	<1.00	3.22	1,630	4,720	NA	
21-Apr-11	<0.500	<2.17	1,870	5,600	NA	
24-Jan-11	<0.00955	4.20	1,590	4,660	NA	
16-Sep-10	0.217	<10.0	1,370	4,320	NA	
29-Jun-10	<0.5	6.18	1,570	5,150	NA	
21-Mar-10	<10	<1.0	2,200	5,620	NA	
9-Dec-09	<10	<5.0	2,100	5,590	NA	
NMED Split	9-Dec-09	<0.1	0.88	1,570	5,300	1,160
	29-Aug-09	<0.10	<5.0	1,400	4,420	NA
	12-May-09	<10	<5.0	1,200	5,000	NA

**TABLE 4. ABATEMENT PLAN MONITORING WELL GROUNDWATER ANALYTICAL RESULTS
DONA ANA DAIRIES, DONA ANA COUNTY, NEW MEXICO**

Monitoring Well	Date Sampled	Nitrate (mg/l)	TKN (mg/l)	Chloride (mg/l)	TDS (mg/l)	Sulfate (mg/l)
DAD-04	30-May-23			Dry		
	6-Mar-23			Dry		
	6-Dec-22	<1.0	<1.0	400	2,020	NA
	31-Aug-22	<1.0	1.3	80	826	NA
	26-May-22	1.1	1.3	150	1,340	NA
	16-Mar-22	2.3	1.3	500	2,510	NA
	1-Dec-21	2.1	1.1	470	2,190	NA
	31-Aug-21	7.5	1.4	450	2,390	NA
	3-Jun-21	5.0	1.4	380	2,300	NA
	2-Mar-21	1.4	1.1	340	2,270	NA
	2-Dec-20	4.4	1.3	310	2,120	NA
	31-Aug-20	<1.0	1.3	330	2,000	NA
	1-Jun-20	<1.0	8.8	320	1,940	NA
	21-Feb-20	<1.0	<1.0	320	1,950	NA
	4-Dec-19	<1.0	<1.0	330	2,020	NA
	19-Aug-19	<1.0	<1.0	320	1,770	NA
	23-May-19	<1.0	<2.0	330	1,720	NA
	5-Mar-19	<1.0	<1.0	340	1,820	NA
	28-Nov-18	<1.0	<1.0	350	1,770	NA
	24-Aug-18	<1.0	<1.0	300	1,700	NA
	31-May-18	<1.0	<1.0	280	1,710	NA
	26-Feb-18	<1.0	<1.0	230	1,520	NA
	20-Nov-17	0.314	0.734	32.3	900	NA
	24-Aug-17	0.109	<0.0500	380	1,920	NA
	8-Jun-17	0.133	0.956	349	1,800	NA
	7-Mar-17	0.257	0.632	317	1,760	NA
	2-Dec-16	1.46	1.41	343	2,040	NA
	6-Sep-16	<0.305	<0.937	497	1,830	NA
	2-Jun-16	0.633	<2.24	547	2,060	NA
	25-Feb-16	<0.305	<1.18	434	1,730	NA
	23-Nov-15	0.0853	6.16	443	1,690	NA
	1-Sep-15	<0.194	2.10	561	2,320	NA
	27-May-15	0.176	<1.18	475	1,820	NA
	4-Mar-15	0.819	<1.80	195	1,280	NA
	3-Dec-14	1.65	<1.80	185	1,260	NA
	29-Aug-14	<0.126	<1.80	483	2,060	NA
	3-Jun-14	0.988	3.50	740	2,810	NA
	10-Mar-14	1.01	<1.66	694	2,600	NA
	11-Dec-13	1.69	<1.66	604	2,400	NA
	5-Sep-13	0.827	9.10	544	2,710	NA
16-May-13	<0.0420	<1.66	613	2,320	NA	
1-Mar-13	2.12	<1.72	510	2,090	NA	
5-Dec-12	2.740	<1.72	545	2,430	NA	
21-Aug-12	<0.0290	<1.72	496	2,620	NA	
9-May-12	0.305	<1.72	502	1,970	NA	
31-Jan-12	2.05	<2.17	493	2,320	NA	
26-Oct-11	<0.500	2.80	590	2,950	380	
20-Jul-11	<0.500	<2.17	670	2,540	NA	
20-Apr-11	<0.500	<2.17	584	2,570	NA	
24-Jan-11	<0.00955	2.66	608	2,400	NA	
16-Sep-10	<0.100	<10.0	683	2,560	NA	
29-Jun-10	<0.5	1.4	570	2,330	NA	
21-Mar-10	<2.0	<2.0	620	2,460	NA	
9-Dec-09	<2.0	1.7	810	2,720	NA	
NMED Split	9-Dec-09	<0.1	1.2	659	2,630	373
	29-Aug-09	<2.0	<5.0	690	2,690	NA
	13-May-09	<2.0	<5.0	690	2,700	NA

**TABLE 4. ABATEMENT PLAN MONITORING WELL GROUNDWATER ANALYTICAL RESULTS
DONA ANA DAIRIES, DONA ANA COUNTY, NEW MEXICO**

Monitoring Well	Date Sampled	Nitrate (mg/l)	TKN (mg/l)	Chloride (mg/l)	TDS (mg/l)	Sulfate (mg/l)
DAD-05	1-Jun-23	<1.0	5.6	120	785	NA
	8-Mar-23	<1.0	4.8	110	830	NA
	8-Dec-22	<1.0	3.4	100	900	NA
	12-Sep-22	<1.0	2.8	82	785	NA
	31-May-22	<1.0	15	300	1,610	NA
	17-Mar-22	<1.0	18	310	1,840	NA
	6-Dec-21	<1.0	22	400	1,950	NA
	2-Sep-21	14	14	410	2,370	NA
	7-Jun-21	<1.0	<1.0	370	1,890	NA
	4-Mar-21	<1.0	<1.0	310	1,630	NA
	2-Dec-20	<1.0	<1.0	290	1,660	NA
	31-Aug-20	1.6	<1.0	220	1,370	NA
	1-Jun-20	<1.0	18	290	1,550	NA
	21-Feb-20	<1.0	<1.0	390	2,030	NA
	5-Dec-19	<1.0	<1.0	260	1,550	NA
	22-Aug-19	<1.0	1.3	400	1,930	NA
	23-May-19	1.9	1.3	460	2,190	NA
	5-Mar-19	2.0	1.3	370	2,260	NA
	29-Nov-18	2.2	<2.0	570	2,570	NA
	24-Aug-18	<1.0	1.5	650	2,820	NA
	31-May-18	<1.0	1.1	720	2,750	NA
	26-Feb-18	<1.0	1.30	660	2,720	NA
	27-Nov-17	2.31	1.51	721	2,720	NA
	25-Aug-17	8.77	<0.0500	459	1,970	NA
	8-Jun-17	1.56	1.13	722	2,850	NA
	7-Mar-17	8.37	1.04	434	2,150	NA
	2-Dec-16	2.70	2.02	653	2,840	NA
	6-Sep-16	5.00	<0.937	614	2,480	NA
	2-Jun-16	5.26	<2.24	611	2,710	NA
	25-Feb-16	9.43	<1.18	654	2,660	NA
	23-Nov-15	<0.194	2.80	493	2,100	NA
	1-Sep-15	2.15	1.40	388	2,100	NA
	27-May-15	4.48	<1.18	436	2,180	NA
	4-Mar-15	10.5	<1.80	564	2,400	NA
	3-Dec-14	2.55	<1.80	273	1,300	NA
	29-Aug-14	1.87	<1.80	230	1,200	NA
	3-Jun-14	2.20	<1.80	497	2,000	NA
	10-Mar-14	4.81	<1.66	312	1,510	NA
	12-Dec-13	0.898	2.80	72.9	695	NA
	5-Sep-13	2.16	4.90	120	870	NA
29-May-13	2.44	<1.66	582	2,580	NA	
5-Mar-13	<0.246	<1.72	519	2,100	NA	
5-Dec-12	3.350	<1.72	690	2,930	NA	
22-Aug-12	<0.0290	<1.72	544	2,260	NA	
9-May-12	0.908	2.10	566	2,380	NA	
1-Feb-12	<0.500	<2.17	558	2,020	NA	
26-Oct-11	<0.500	2.66	647	900	377	
20-Jul-11	<0.500	5.04	599	2,460	NA	
20-Apr-11	<0.500	<2.17	430	1,810	NA	
20-Jan-11	0.128	2.10	477	1,870	NA	
16-Sep-10	<2.50	<10.0	536	2,220	NA	
29-Jun-10	< 0.5	1.1	627	2,550	NA	
21-Mar-10	<2.0	<1.0	630	2,340	NA	
9-Dec-09	<2.0	1.3	710	2,420	NA	
NMED Split	9-Dec-09	<0.1	0.95	563	2,290	362
	29-Aug-09	<2.0	<2.0	630	2,310	NA
	13-May-09	<2.0	<5.0	640	2,700	NA
Duplicate	13-May-09	<10	1.6	618	2,260	NA

**TABLE 4. ABATEMENT PLAN MONITORING WELL GROUNDWATER ANALYTICAL RESULTS
DONA ANA DAIRIES, DONA ANA COUNTY, NEW MEXICO**

Monitoring Well	Date Sampled	Nitrate (mg/l)	TKN (mg/l)	Chloride (mg/l)	TDS (mg/l)	Sulfate (mg/l)
DAD-06	4-Nov-22	Plugged and Abandoned				
	13-Sep-22	Dry				
	27-May-22	Dry				
	9-Feb-22	Dry				
	1-Dec-21	Dry				
	31-Aug-21	Dry				
	4-Jun-21	Dry				
	3-Mar-21	Dry				
	1-Dec-20	Dry				
	31-Aug-20	Dry				
	1-Jun-20	Dry				
	9-Mar-20	Dry				
	4-Dec-19	Dry				
	12-Aug-19	Dry				
	28-May-19	Dry				
	14-Mar-19	Dry				
	4-Dec-18	Dry				
	31-Aug-18	Dry				
	4-Jun-18	Dry				
	28-Feb-18	Dry				
	28-Nov-17	Dry				
	28-Aug-17	Dry				
	12-Jun-17	Dry				
	13-Mar-17	Dry				
	6-Dec-16	Dry				
	8-Sep-16	Dry				
	6-Jun-16	Dry				
	25-Feb-16	Dry				
	23-Nov-15	Dry				
	1-Sep-15	Dry				
	28-May-15	Dry				
	4-Mar-15	Dry				
	4-Dec-14	Dry				
12-Aug-14	Dry					
13-May-14	Dry					
10-Mar-14	Dry					
11-Dec-13	Dry					
5-Sep-13	Dry					
30-May-13	6.07	<1.66	508	1,690	NA	
4-Mar-13	7.66	<1.72	496	1,510	NA	
5-Dec-12	8.25	<1.72	439	1,610	NA	
21-Aug-12	9.11	2.10	347	1,530	NA	
9-May-12	11.0	<1.72	375	1,570	NA	
31-Jan-12	13.6	<2.17	382	1,510	NA	
27-Oct-11	9.20	<2.17	322	1,060	228	
20-Jul-11	18.0	3.64	358	1,370	NA	
21-Apr-11	18.0	<2.17	349	1,330	NA	
24-Jan-11	12.2	2.10	360	1,270	NA	
16-Sep-10	9.20	<10.0	359	1,370	NA	
29-Jun-10	11.6	<2.0	365	1,460	NA	
21-Mar-10	10	<2.0	390	1,390	NA	
9-Dec-09	10	<1.0	380	1,380	NA	
NMED Split	9-Dec-09	8.6	0.36	354	1,440	262
	29-Aug-09	8.2	<5.0	390	1,260	NA
	14-May-09	11	<5.0	350	1,300	NA
Duplicate	14-May-09	8.17	0.4	338	1,250	NA
DAD-06R	30-May-23	6.4	5.6	84	580	NA
	7-Mar-23	4.5	<1.0	88	610	NA
	6-Dec-22	3.9	1.7	100	696	NA

**TABLE 4. ABATEMENT PLAN MONITORING WELL GROUNDWATER ANALYTICAL RESULTS
DONA ANA DAIRIES, DONA ANA COUNTY, NEW MEXICO**

Monitoring Well	Date Sampled	Nitrate (mg/l)	TKN (mg/l)	Chloride (mg/l)	TDS (mg/l)	Sulfate (mg/l)
DAD-07	5-Jun-23	25	<5.0	530	2,400	NA
	9-Mar-23	19	<2.0	450	2,120	NA
	7-Dec-22	20	<5.0	410	2,060	NA
	13-Sep-22	17	<2.0	370	1,890	NA
	1-Jun-22	17	<2.0	410	2,000	NA
	22-Mar-22	18	<2.0	480	2,160	NA
	7-Dec-21	18	<2.0	500	2,200	NA
	1-Sep-21	18	<1.0	600	2,310	NA
	4-Jun-21	18	<2.0	630	2,340	NA
	3-Mar-21	17	<2.0	630	2,420	NA
	4-Dec-20	17	<2.0	650	2,550	NA
	3-Sep-20	16	<2.0	740	2,520	NA
	3-Jun-20	15	<2.0	570	2,310	NA
	25-Feb-20	14	<2.0	570	2,190	NA
	5-Dec-19	13	<2.0	520	2,140	NA
	21-Aug-19	13	<2.0	560	2,190	NA
	24-May-19	12	<2.0	540	2,140	NA
	8-Mar-19	12	<2.0	530	2,050	NA
	29-Nov-18	11	<2.0	500	1,980	NA
	27-Aug-18	12	<2.0	500	2,060	NA
	1-Jun-18	12	<2.0	540	2,260	NA
	27-Feb-18	12	<2.0	740	2,530	NA
	28-Nov-17	12.3	<0.0500	701	2,160	NA
	28-Aug-17	11.2	<0.0500	576	2,040	NA
	6-Jun-17	7.69	<0.0500	529	2,030	NA
	10-Mar-17	6.07	<0.0501	480	1,800	NA
	5-Dec-16	4.97	<0.300	467	1,820	NA
	7-Sep-16	5.50	<0.937	583	1,940	NA
	8-Jun-16	4.87	<2.24	526	1,820	NA
	1-Mar-16	5.27	<1.18	609	2,020	NA
	30-Nov-15	6.82	<1.18	638	2,020	NA
	1-Sep-15	7.45	<1.18	649	2,060	NA
	28-May-15	5.83	<1.18	619	1,960	NA
	5-Mar-15	5.34	<1.80	554	2,060	NA
	3-Dec-14	6.85	<1.80	607	2,180	NA
	2-Sep-14	7.48	<1.80	589	2,150	NA
	12-Jun-14	5.44	<1.80	540	2,020	NA
	11-Mar-14	4.84	2.10	512	1,980	NA
	11-Dec-13	7.94	<1.66	700	2,270	NA
	5-Sep-13	7.01	3.50	650	2,380	NA
24-May-13	8.42	<1.66	720	2,570	NA	
5-Mar-13	8.15	<1.72	724	2,740	NA	
5-Dec-12	8.03	<1.72	718	2,610	NA	
22-Aug-12	6.88	<1.72	671	2,540	NA	
9-May-12	3.81	<1.72	588	2,150	NA	
31-Jan-12	5.40	<2.17	610	1,640	NA	
26-Oct-11	5.22	2.24	591	750	426	
20-Jul-11	4.67	2.80	554	1,880	NA	
20-Apr-11	4.14	<2.17	525	1,780	NA	
19-Jan-11	0.410	<2.05	518	1,740	NA	
16-Sep-10	<2.50	<10.0	637	1,990	NA	
29-Jun-10	5.17	<0.5	569	2,060	NA	
21-Mar-10	5.1	<1.0	640	1,970	NA	
9-Dec-09	5.4	<1.0	620	1,900	NA	
NMED Split	9-Dec-09	5.2	<0.1	536	1,870	403
	29-Aug-09	4.4	<5.0	610	1,780	NA
	14-May-09	4.6	<1.0	530	1,800	NA

**TABLE 4. ABATEMENT PLAN MONITORING WELL GROUNDWATER ANALYTICAL RESULTS
DONA ANA DAIRIES, DONA ANA COUNTY, NEW MEXICO**

Monitoring Well	Date Sampled	Nitrate (mg/l)	TKN (mg/l)	Chloride (mg/l)	TDS (mg/l)	Sulfate (mg/l)
DAD-08	5-Jun-23	44	<5.0	1,600	4,240	NA
	8-Mar-23	45	<5.0	1,600	4,260	NA
	8-Dec-22	45	14	1,500	3,960	NA
	12-Sep-22	46	11	1,600	4,780	NA
	31-May-22	47	<5.0	1,800	4,700	NA
	18-Mar-22	44	<5.0	1,600	4,520	NA
	6-Dec-21	46	<5.0	1,700	4,490	NA
	2-Sep-21	46	<5.0	1,900	4,580	NA
	7-Jun-21	50	<5.0	2,000	5,040	NA
	3-Mar-21	45	<5.0	1,800	4,880	NA
	3-Dec-20	42	<5.0	1,800	4,660	NA
	2-Sep-20	42	<5.0	1,800	4,770	NA
	2-Jun-20	43	<5.0	1,800	5,070	NA
	21-Feb-20	40	<5.0	1,800	4,930	NA
	4-Dec-19	43	<1.0	1,800	4,920	NA
	19-Aug-19	39	<5.0	1,800	5,270	NA
	23-May-19	47	<5.0	1,800	5,540	NA
	5-Mar-19	42	<5.0	1,900	5,460	NA
	29-Nov-18	40	<5.0	1,800	4,760	NA
	24-Aug-18	47	<5.0	2,000	5,680	NA
	31-May-18	43	<5.0	1,900	5,400	NA
	26-Feb-18	51	<5.0	1,700	4,710	NA
	27-Nov-17	32.9	0.717	1,580	4,290	NA
	25-Aug-17	32.8	<0.0500	1,450	6,480	NA
	8-Jun-17	37.9	<0.100	1,670	5,140	NA
	7-Mar-17	44.8	<0.300	1,860	5,420	NA
	2-Dec-16	45.9	<0.300	1,990	5,800	NA
	6-Sep-16	44.4	<0.937	1,950	5,940	NA
	2-Jun-16	52.9	<2.24	1,960	5,840	NA
	25-Feb-16	51.2	5.60	1,990	5,740	NA
	23-Nov-15	66.1	<1.18	2,070	5,980	NA
	1-Sep-15	65.3	<1.18	2,050	6,160	NA
	28-May-15	63.0	<1.18	2,050	5,840	NA
	5-Mar-15	48.6	<1.80	1,670	5,740	NA
	3-Dec-14	48.1	<1.80	1,700	5,930	NA
	2-Sep-14	39.5	<1.80	1,700	5,220	NA
	4-Jun-14	55.8	2.10	2,210	5,840	NA
	11-Mar-14	71.7	<1.66	2,450	6,400	NA
	12-Dec-13	70.7	2.80	2,500	6,780	NA
	5-Sep-13	74.9	2.80	2,440	7,440	NA
24-May-13	71.5	<1.66	2,140	6,740	NA	
4-Mar-13	90.0	<1.72	2,280	7,060	NA	
5-Dec-12	40.2	<1.72	2,270	5,980	NA	
22-Aug-12	32.2	<1.72	2,430	7,220	NA	
9-May-12	2.39	<1.72	1,150	3,260	NA	
31-Jan-12	2.69	<2.17	1,250	2,990	NA	
26-Oct-11	2.80	<2.17	1,260	2,500	471	
20-Jul-11	3.36	3.78	1,320	3,060	NA	
20-Apr-11	4.33	<2.17	1,300	3,280	NA	
19-Jan-11	<0.239	2.10	1,240	2,600	NA	
17-Sep-10	<2.50	<10.0	1,370	3,230	NA	
29-Jun-10	2.53	<1.0	1,290	5,950	NA	
21-Mar-10	<4.0	<1.0	1,300	3,270	NA	
9-Dec-09	<4.0	<1.0	1,400	3,290	NA	
NMED Split	9-Dec-09	3.1	0.26	1,400	3,070	509
	29-Aug-09	<4.0	<2.0	1,500	3,180	NA
	14-May-09	3.0	<5.0	1,300	3,600	NA

**TABLE 4. ABATEMENT PLAN MONITORING WELL GROUNDWATER ANALYTICAL RESULTS
DONA ANA DAIRIES, DONA ANA COUNTY, NEW MEXICO**

Monitoring Well	Date Sampled	Nitrate (mg/l)	TKN (mg/l)	Chloride (mg/l)	TDS (mg/l)	Sulfate (mg/l)
DAD-15	30-May-23	15	<2.0	640	2,320	NA
	6-Mar-23	17	<2.0	780	2,470	NA
	5-Dec-22	17	<2.0	650	2,500	NA
	31-Aug-22	22	<5.0	680	2,550	NA
	26-May-22	20	<5.0	770	2,510	NA
	23-Mar-22	22	<5.0	640	2,590	NA
	2-Dec-21	20	<5.0	700	2,470	NA
	31-Aug-21	17	<2.0	640	2,230	NA
	4-Jun-21	12	<2.0	760	2,280	NA
	4-Mar-21	18	<2.0	650	2,310	NA
	4-Dec-20	17	<2.0	590	2,230	NA
	3-Sep-20	14	<2.0	600	2,210	NA
	1-Jun-20	11	<2.0	600	2,060	NA
	26-Feb-20	11	<2.0	610	2,010	NA
	5-Dec-19	9.8	1.4	520	2,010	NA
	21-Aug-19	13	<1.0	610	2,180	NA
	24-May-19	9.9	<2.0	580	2,160	NA
	8-Mar-19	7.5	<1.0	540	1,970	NA
	30-Nov-18	6.2	<1.0	530	1,840	NA
	27-Aug-18	8.9	<1.0	530	2,080	NA
	1-Jun-18	7.1	<1.0	520	1,960	NA
	27-Feb-18	7.4	<1.0	550	1,970	NA
	20-Nov-17	6.98	<0.300	578	1,710	NA
	28-Aug-17	4.60	<0.0500	502	1,670	NA
	9-Jun-17	6.07	<0.100	532	1,870	NA
	13-Mar-17	5.74	<0.0501	526	1,860	NA
	5-Dec-16	5.12	<0.300	496	1,660	NA
	7-Sep-16	4.21	<0.937	506	1,780	NA
	8-Jun-16	4.41	<2.24	466	1,680	NA
	29-Feb-16	4.30	3.36	536	1,720	NA
	24-Nov-15	5.06	<1.18	538	1,720	NA
	1-Sep-15	4.20	<1.18	501	1,760	NA
	29-May-15	5.43	<1.18	536	1,940	NA
6-Mar-15	5.08	<1.80	491	1,780	NA	
4-Dec-14	5.79	<1.80	508	1,730	NA	
2-Sep-14	5.97	<1.80	489	1,620	NA	
6-Jun-14	6.09	<1.80	510	1,750	NA	
2-Jan-14	4.72	2.10	497	1,780	NA	
10-Sep-13	7.56	3.50	356	1,740	NA	
29-May-13	5.29	<1.66	504	1,970	NA	
4-Mar-13	5.10	<1.72	515	1,800	NA	
4-Dec-12	4.710	<1.72	484	1,810	256	
20-Aug-12	2.370	35.00	351	1,330	256	

**TABLE 4. ABATEMENT PLAN MONITORING WELL GROUNDWATER ANALYTICAL RESULTS
DONA ANA DAIRIES, DONA ANA COUNTY, NEW MEXICO**

Monitoring Well	Date Sampled	Nitrate (mg/l)	TKN (mg/l)	Chloride (mg/l)	TDS (mg/l)	Sulfate (mg/l)
DAD-16	30-May-23	<1.0	<1.0	330	1,760	NA
	6-Mar-23	<1.0	<1.0	410	1,910	NA
	6-Dec-22	<1.0	<1.0	330	1,880	NA
	31-Aug-22	<1.0	<1.0	430	2,120	NA
	26-May-22	<1.0	<1.0	530	2,180	NA
	16-Mar-22	<1.0	<1.0	490	2,100	NA
	1-Dec-21	<1.0	<1.0	540	2,160	NA
	31-Aug-21	<1.0	<1.0	530	2,170	NA
	4-Jun-21	<1.0	<1.0	560	2,250	NA
	3-Mar-21	<1.0	<1.0	430	2,030	NA
	2-Dec-20	<1.0	<1.0	500	2,170	NA
	31-Aug-20	<1.0	<1.0	520	2,200	NA
	1-Jun-20	<1.0	3.1	520	2,080	NA
	25-Feb-20	<1.0	<1.0	400	1,950	NA
	5-Dec-19	<1.0	<1.0	470	2,130	NA
	20-Aug-19	<1.0	<2.0	480	2,100	NA
	23-May-19	<1.0	<2.0	420	2,010	NA
	8-Mar-19	<1.0	<1.0	450	1,990	NA
	29-Nov-18	<1.0	<1.0	520	2,200	NA
	27-Aug-18	<1.0	<1.0	550	2,410	NA
	1-Jun-18	<1.0	<1.0	620	2,440	NA
	27-Feb-18	0.51	<1.0	390	1,780	NA
	28-Nov-17	0.246	0.963	583	2,120	NA
	28-Aug-17	1.18	0.304	723	2,450	NA
	6-Jun-17	0.656	1.11	666	2,710	NA
	8-Mar-17	0.993	0.804	649	2,690	NA
	2-Dec-16	1.76	3.14	342	1,900	NA
	7-Sep-16	1.56	<0.937	821	3,000	NA
	6-Jun-16	1.02	<2.24	423	2,070	NA
	29-Feb-16	0.327	6.72	629	2,440	NA
	30-Nov-15	1.25	<1.18	611	2,520	NA
	2-Sep-15	2.72	1.40	424	1,970	NA
	29-May-15	3.30	1.40	431	2,060	NA
	5-Mar-15	1.04	<1.80	683	2,650	NA
	4-Dec-14	2.79	<1.80	679	2,220	NA
	2-Sep-14	2.44	<1.80	579	2,300	NA
	3-Jun-14	1.49	2.10	569	2,260	NA
	10-Mar-14	1.65	<1.66	573	2,100	NA
	12-Dec-13	1.28	2.10	561	2,210	NA
	9-Sep-13	0.832	4.20	538	2,260	NA
29-May-13	1.68	<1.66	501	2,200	NA	
5-Mar-13	2.55	<1.72	674	2,670	NA	
5-Dec-12	2.420	<1.72	529	2,280	NA	
22-Aug-12	<0.0290	<1.72	472	2,000	NA	
14-May-12	0.147	<1.72	378	2,080	NA	
1-Feb-12	<0.500	<2.17	438	1,960	NA	
27-Oct-11	<0.500	3.36	410	1,520	408	

**TABLE 4. ABATEMENT PLAN MONITORING WELL GROUNDWATER ANALYTICAL RESULTS
DONA ANA DAIRIES, DONA ANA COUNTY, NEW MEXICO**

Monitoring Well	Date Sampled	Nitrate (mg/l)	TKN (mg/l)	Chloride (mg/l)	TDS (mg/l)	Sulfate (mg/l)
DAD-17	1-Jun-23	<1.0	<1.0	190	968	NA
	8-Mar-23	<1.0	<1.0	170	938	NA
	8-Dec-22	<1.0	<1.0	170	878	NA
	1-Sep-22	<1.0	<1.0	140	853	NA
	31-May-22	<1.0	<1.0	190	936	NA
	17-Mar-22	2.7	<1.0	170	985	NA
	6-Dec-21	1.2	<1.0	190	985	NA
	2-Sep-21	2.6	<1.0	130	742	NA
	7-Jun-21	4.0	<1.0	180	972	NA
	4-Mar-21	1.3	<1.0	96	634	NA
	2-Dec-20	<1.0	<1.0	92	604	NA
	2-Sep-20	1.8	<1.0	73	586	NA
	2-Jun-20	1.7	<1.0	86	698	NA
	25-Feb-20	<1.0	<1.0	71	554	NA
	5-Dec-19	1.5	<1.0	65	582	NA
	21-Aug-19	4.9	<1.0	120	785	NA
	23-May-19	1.3	<2.0	74	650	NA
	8-Mar-19	2.4	<1.0	89	638	NA
	29-Nov-18	<1.0	<1.0	70	624	NA
	24-Aug-18	2.0	<1.0	56	580	NA
	31-May-18	1.2	<1.0	60	620	NA
	27-Feb-18	0.62	<1.0	54	572	NA
	28-Nov-17	3.17	0.169	65.4	690	NA
	25-Aug-17	10.3	<0.0500	454	1,740	NA
	7-Jun-17	0.939	0.234	84.2	970	NA
	13-Mar-17	0.509	0.352	103	885	NA
	5-Dec-16	1.46	0.370	126	755	NA
	8-Sep-16	1.89	<0.937	169	1,100	NA
	6-Jun-16	0.626	<2.24	240	1,440	NA
	1-Mar-16	<0.0610	<1.18	183	1,260	NA
	30-Nov-15	<0.0387	<1.18	373	1,550	NA
	2-Sep-15	<0.0387	<1.18	270	1,460	NA
	28-May-15	0.486	<1.18	199	1,560	NA
	5-Mar-15	0.797	<1.80	348	1,660	NA
5-Dec-14	6.87	<1.80	451	1,820	NA	
3-Sep-14	2.48	<1.80	442	1,920	NA	
3-Jun-14	1.03	<1.80	525	2,600	NA	
11-Mar-14	3.27	<3.32	440	1,820	NA	
12-Dec-13	2.45	2.80	412	1,640	NA	
9-Sep-13	0.370	2.10	451	2,340	NA	
24-May-13	0.827	<1.66	317	1,400	NA	
5-Mar-13	2.06	<1.72	351	1,550	NA	
5-Dec-12	2.28	<1.72	230	1,260	NA	
22-Aug-12	<0.0290	<1.72	189	930	NA	
10-May-12	<0.114	<1.72	353	1,580	NA	
1-Feb-12	<0.500	3.36	113	714	NA	
26-Oct-11	<0.500	3.50	175	724	186	

**TABLE 4. ABATEMENT PLAN MONITORING WELL GROUNDWATER ANALYTICAL RESULTS
DONA ANA DAIRIES, DONA ANA COUNTY, NEW MEXICO**

Monitoring Well	Date Sampled	Nitrate (mg/l)	TKN (mg/l)	Chloride (mg/l)	TDS (mg/l)	Sulfate (mg/l)
DAD-18 Vertical Delineation	5-Jun-23	7.4	<1.0	680	2,660	NA
	8-Mar-23	6.9	<1.0	690	2,700	NA
	8-Dec-22	6.8	1.1	720	2,670	NA
	12-Sep-22	7.6	16	600	2,590	NA
	31-May-22	7.7	<1.0	690	2,580	NA
	18-Mar-22	6.3	1.1	590	2,530	NA
	6-Dec-21	7.0	<1.0	640	2,510	NA
	2-Sep-21	7.4	<1.0	640	2,580	NA
	7-Jun-21	7.4	<1.0	670	2,700	NA
	4-Mar-21	7.9	<1.0	690	2,660	NA
	3-Dec-20	8.5	<1.0	720	2,730	NA
	2-Sep-20	8.0	<1.0	690	2,740	NA
	2-Jun-20	8.1	<1.0	670	2,760	NA
	25-Feb-20	9.3	<1.0	660	2,690	NA
	5-Dec-19	8.7	<1.0	570	2,620	NA
	20-Aug-19	10	<2.0	650	2,640	NA
	28-May-19	9.5	<2.0	650	2,620	NA
	11-Mar-19	9.4	<2.0	620	2,600	NA
	29-Nov-18	10	<2.0	680	2,650	NA
	28-Aug-18	12	<2.0	630	2,720	NA
	4-Jun-18	12	<2.0	720	2,740	NA
	28-Feb-18	15	<2.0	560	2,750	NA
	29-Nov-17	10.6	0.840	684	2,520	NA
	29-Aug-17	13.6	0.475	620	2,570	NA
	12-Jun-17	10.4	0.652	710	2,760	NA
	8-Mar-17	9.07	0.242	684	2,750	NA
	5-Dec-16	7.88	0.713	684	2,730	NA
	9-Sep-16	6.85	<0.937	688	2,650	NA
	6-Jun-16	8.04	<2.24	671	2,830	NA
	1-Mar-16	8.55	<1.18	918	2,860	NA
	30-Nov-15	8.19	1.68	923	2,760	NA
	2-Sep-15	8.47	3.50	741	2,960	NA
	28-May-15	9.86	1.40	825	2,940	NA
	5-Mar-15	10.0	<1.80	736	2,930	NA
	5-Dec-14	19.3	<1.80	623	2,780	NA
	3-Sep-14	12.1	<1.80	713	2,960	NA
	3-Jun-14	13.2	<1.80	749	2,760	NA
	11-Mar-14	12.8	<1.66	739	2,880	NA
	12-Dec-13	11.8	2.10	719	2,840	NA
	9-Sep-13	10.9	2.80	697	3,040	NA
29-May-13	11.9	<1.66	734	3,020	NA	
5-Mar-13	11.2	<1.72	712	2,700	NA	
5-Dec-12	10.10	<1.72	643	2,690	NA	
22-Aug-12	9.03	4.62	642	2,790	NA	
10-May-12	9.11	<1.72	558	2,700	NA	
1-Feb-12	9.62	<2.17	629	2,470	NA	
7-Dec-11	9.21	<2.17	639	2,670	495	

**TABLE 4. ABATEMENT PLAN MONITORING WELL GROUNDWATER ANALYTICAL RESULTS
DONA ANA DAIRIES, DONA ANA COUNTY, NEW MEXICO**

Monitoring Well	Date Sampled	Nitrate (mg/l)	TKN (mg/l)	Chloride (mg/l)	TDS (mg/l)	Sulfate (mg/l)
DAD-19 Vertical Delineation	1-Jun-23	33	<5.0	980	3,060	NA
	7-Mar-23	31	<5.0	970	3,060	NA
	7-Dec-22	30	<5.0	960	3,050	NA
	1-Sep-22	32	<5.0	970	3,040	NA
	27-May-22	34	<5.0	1,000	2,960	NA
	17-Mar-22	27	<5.0	980	2,960	NA
	2-Dec-21	36	<5.0	970	3,050	NA
	1-Sep-21	36	<5.0	1,000	3,060	NA
	4-Jun-21	35	<5.0	1,000	2,960	NA
	3-Mar-21	29	<5.0	940	2,810	NA
	4-Dec-20	33	<2.0	920	2,970	NA
	3-Sep-20	30	<5.0	970	2,920	NA
	2-Jun-20	28	<5.0	930	2,890	NA
	25-Feb-20	33	<5.0	940	3,020	NA
	4-Dec-19	35	<1.0	1,000	3,110	NA
	20-Aug-19	46	<5.0	1,000	3,170	NA
	28-May-19	41	<5.0	1,000	3,090	NA
	11-Mar-19	34	<5.0	970	2,920	NA
	30-Nov-18	35	<5.0	990	2,960	NA
	28-Aug-18	24	<5.0	960	2,950	NA
	4-Jun-18	39	<5.0	980	3,070	NA
	28-Feb-18	33	<5.0	890	3,040	NA
	29-Nov-17	25.3	<0.0500	1,040	2,750	NA
	29-Aug-17	30.7	<0.0500	864	2,770	NA
	12-Jun-17	20.7	<0.100	928	2,790	NA
	13-Mar-17	30.7	<0.0501	970	2,870	NA
	6-Dec-16	22.5	<0.300	944	3,420	NA
	9-Sep-16	25.2	<0.937	418	2,910	NA
	8-Jun-16	24.5	<2.24	1,830	2,920	NA
	1-Mar-16	36.3	<1.18	1,060	3,200	NA
	30-Nov-15	41.2	<1.18	1,050	3,260	NA
	2-Sep-15	36.9	<1.18	1,000	3,260	NA
	28-May-15	43.6	<1.18	994	3,240	NA
	6-Mar-15	46.2	<1.80	966	3,160	NA
	5-Dec-14	10.7	<1.80	782	2,670	NA
	3-Sep-14	41.0	<1.80	899	3,240	NA
4-Jun-14	54.3	<1.80	914	3,220	NA	
18-Mar-14	50.3	<1.66	861	3,130	NA	
12-Dec-13	48.9	2.10	930	3,240	NA	
9-Sep-13	54.6	<1.66	1,260	3,270	NA	
30-May-13	71.3	<1.66	951	3,560	NA	
4-Mar-13	69.1	<1.72	986	3,430	NA	
5-Dec-12	54.2	<1.72	851	3,230	NA	
21-Aug-12	59.2	<1.72	843	3,470	NA	
10-May-12	54.8	<1.72	835	3,460	NA	
1-Feb-12	59.8	<2.17	913	2,950	NA	
7-Dec-11	47.4	<2.17	789	3,070	544	

**TABLE 4. ABATEMENT PLAN MONITORING WELL GROUNDWATER ANALYTICAL RESULTS
DONA ANA DAIRIES, DONA ANA COUNTY, NEW MEXICO**

Monitoring Well	Date Sampled	Nitrate (mg/l)	TKN (mg/l)	Chloride (mg/l)	TDS (mg/l)	Sulfate (mg/l)
DAD-24 Vertical Delineation	1-Jun-23	6.0	<1.0	990	2,790	NA
	7-Mar-23	5.9	<1.0	970	2,790	NA
	7-Dec-22	5.7	<1.0	940	2,780	NA
	1-Sep-22	5.4	<1.0	1,000	2,710	NA
	27-May-22	5.9	<1.0	1,000	2,610	NA
	17-Mar-22	5.5	<1.0	890	2,620	NA
	2-Dec-21	5.4	<1.0	980	2,610	NA
	1-Sep-21	6.5	<1.0	960	2,690	NA
	4-Jun-21	5.6	<1.0	1,000	2,560	NA
	3-Mar-21	5.5	<1.0	970	2,540	NA
	4-Dec-20	5.4	<1.0	920	2,600	NA
	2-Sep-20	5.6	<1.0	940	2,630	NA
	2-Jun-20	5.5	<1.0	910	2,650	NA
	25-Feb-20	5.5	<1.0	920	2,510	NA
	4-Dec-19	6.2	<1.0	950	2,550	NA
	20-Aug-19	5.8	<1.0	950	2,630	NA
	28-May-19	6.1	<1.0	980	2,590	NA
	11-Mar-19	6.0	<1.0	940	2,490	NA
	30-Nov-18	6.5	<1.0	940	2,560	NA
	31-Aug-18	6.1	<1.0	930	2,600	NA
	4-Jun-18	6.5	<1.0	960	2,570	NA
	28-Feb-18	5.8	<1.0	810	2,480	NA
	29-Nov-17	6.25	<0.0500	994	2,220	NA
	29-Aug-17	4.10	<0.0500	910	2,420	NA
	12-Jun-17	6.94	<0.100	969	2,630	NA
13-Mar-17	6.84	<0.0501	947	2,530	NA	
28-Dec-16	NA	NA	NA	2,600	NA	
6-Dec-16	6.19	<0.300	938	2,630 R	NA	
9-Sep-16	1.84	<0.937	425	1,620	NA	
8-Jun-16	2.55	<2.24	482	1,620	NA	
1-Mar-16	2.22	<1.18	511	1,670	NA	
DAD-25	5-Jun-23	7.9	<1.0	780	2,160	NA
	9-Mar-23	7.7	<1.0	740	1,740	NA
	8-Dec-22	5.8	<1.0	590	1,940	NA
	12-Sep-22	4.8	<1.0	550	1,820	NA
	1-Jun-22	4.4	<1.0	420	1,780	NA
	18-Mar-22	3.4	<2.0	120	840	NA
	7-Dec-21	2.8	2.2	170	1,220	NA
	3-Sep-21	9.5	<2.0	140	880	NA
	7-Jun-21	9.0	<2.0	940	2,440	NA
	4-Mar-21	8.2	<2.0	880	2,030	NA
	3-Dec-20	7.7	<2.0	850	2,080	NA
	2-Sep-20	7.4	<2.0	760	2,180	NA
	2-Jun-20	7.5	<1.0	700	2,500	NA
	26-Feb-20	7.6	<2.0	760	2,100	NA
	6-Dec-19	7.0	<2.0	640	1,800	NA
	22-Aug-19	5.6	<2.0	600	1,830	NA
	28-May-19	5.5	<5.0	600	1,790	NA
	11-Mar-19	4.8	<1.0	560	1,570	NA
	29-Nov-18	5.0	<1.0	550	1,580	NA
	28-Aug-18	5.0	<2.0	510	1,800	NA
	4-Jun-18	5.6	<2.0	550	1,540	NA
	27-Feb-18	6.3	<1.0	490	1,480	NA
	27-Nov-17	6.78	0.411	456	1,310	NA
	25-Aug-17	20.1	0.768	414	1,660	NA
	8-Jun-17	10.1	<0.100	678	1,940	NA
10-Mar-17	22.5	<0.0501	954	2,920	NA	
2-Dec-16	31.9	<0.300	1,350	3,750	NA	
8-Sep-16	32.6	<0.937	1,420	4,010	NA	
6-Jun-16	24.8	<2.24	1,390	3,400	NA	
1-Mar-16	52.5	<1.18	1,380	4,020	NA	
22-Dec-15	57.9	<1.18	1,580	4,640	NA	
NMWQCC Standard		10	NA	250	1,000	600
Existing Conditions - August 2020		NA	NA	367	1,758	NA
Existing Conditions - Pre-August 2020*		NA	NA	1,781	5,328	NA

**TABLE 4. ABATEMENT PLAN MONITORING WELL GROUNDWATER ANALYTICAL RESULTS
DONA ANA DAIRIES, DONA ANA COUNTY, NEW MEXICO**

Monitoring Well	Date Sampled	Nitrate (mg/l)	TKN (mg/l)	Chloride (mg/l)	TDS (mg/l)	Sulfate (mg/l)
Southern Portion						
DAD-09 Perched Aquifer	6-Jun-23	33	<5.0	520	1,890	NA
	9-Mar-23	35	<5.0	520	1,880	NA
	9-Dec-22	36	<5.0	570	1,920	NA
	13-Sep-22	32	<5.0	480	1,960	NA
	1-Jun-22	33	<5.0	510	1,960	NA
	22-Mar-22	32	<5.0	510	1,860	NA
	7-Dec-21	35	<5.0	380	1,540	NA
	3-Sep-21	42	<5.0	93	785	NA
	28-May-21	24	<5.0	450	1,800	NA
	8-Mar-21	29	<5.0	510	1,900	NA
	7-Dec-20	24	<5.0	490	1,840	NA
	3-Sep-20	22	<5.0	450	1,720	NA
	3-Jun-20	46	<5.0	550	2,350	NA
	19-Feb-20	72	<5.0	610	2,230	NA
	6-Dec-19	40	<5.0	250	1,340	NA
	21-Aug-19	120	<2.0	890	3,380	NA
	24-May-19	120	<5.0	900	3,410	NA
	7-Mar-19	100	<5.0	950	3,290	NA
	30-Nov-18	74	<5.0	910	3,080	NA
	27-Aug-18	76	<5.0	780	2,910	NA
	4-Jun-18	66	<5.0	870	2,690	NA
	28-Feb-18	60	<5.0	680	2,560	NA
	28-Nov-17	49.0	<0.0500	816	2,290	NA
	23-Aug-17	43.9	<0.0500	665	2,050	NA
	9-Jun-17	66.8	<0.100	773	3,300	NA
	10-Mar-17	55.4	<0.0501	667	2,530	NA
	6-Dec-16	50.2	<0.300	676	2,470	NA
	7-Sep-16	36.0	<0.937	619	2,280	NA
	6-Jun-16	34.9	<2.24	583	2,240	NA
	29-Feb-16	16.2	<1.18	574	2,050	NA
	23-Nov-15	4.95	<1.18	563	1,940	NA
	2-Sep-15	7.22	<1.18	536	1,920	NA
	27-May-15	5.25	<1.18	508	1,920	NA
	4-Mar-15	4.01	<1.80	474	1,800	NA
	5-Dec-14	4.27	<1.80	495	1,800	NA
	28-Aug-14	5.25	<1.80	466	1,720	NA
	4-Jun-14	3.14	<1.80	440	1,580	NA
	18-Mar-14	3.44	<1.66	418	1,480	NA
	16-Dec-13	17.4	<1.66	294	1,200	NA
	30-Aug-13	12.3	2.10	454	1,800	NA
	30-May-13	9.69	<1.66	435	1,740	NA
6-Mar-13	17.1	<1.72	494	1,840	NA	
4-Dec-12	33.1	<1.72	588	2,200	NA	
20-Aug-12	48.4	<1.72	656	2,540	NA	
10-May-12	50.9	<1.72	561	2,270	NA	
31-Jan-12	59.8	<2.17	622	2,220	NA	
26-Oct-11	77.7	<2.17	728	1,600	433	
20-Jul-11	70.2	<2.17	727	2,500	NA	
20-Apr-11	47.5	<2.17	483	1,910	NA	
19-Jan-11	42.8	2.38	745	2,600	NA	
17-Sep-10	22.6	<10.0	204	47	NA	
29-Jun-10	59.2	<5.0	667	2,240	NA	
21-Mar-10	29	<5.0	290	1,190	NA	
9-Dec-09	26	<5.0	300	1,190	NA	
NMED Split	9-Dec-09	22	1.6	228	1,170	152
	29-Aug-09	46	<5.0	640	2,320	NA
	13-May-09	44	<5.0	740	2,400	NA

**TABLE 4. ABATEMENT PLAN MONITORING WELL GROUNDWATER ANALYTICAL RESULTS
DONA ANA DAIRIES, DONA ANA COUNTY, NEW MEXICO**

Monitoring Well	Date Sampled	Nitrate (mg/l)	TKN (mg/l)	Chloride (mg/l)	TDS (mg/l)	Sulfate (mg/l)
DAD-10 Regional Aquifer	9-Jun-23	1.1	<1.0	400	1,330	NA
	10-Mar-23	1.3	<2.0	440	1,530	NA
	9-Dec-22	1.2	<1.0	420	1,280	NA
	14-Sep-22	<1.0	<1.0	360	1,250	NA
	2-Jun-22	1.2	<1.0	390	1,400	200
	23-Mar-22	1.4	<1.0	390	1,660	NA
	8-Dec-21	1.4	<2.0	460	1,750	NA
	24-Aug-21	1.0	<1.0	400	1,490	NA
	28-May-21	<1.0	<2.0	390	1,330	NA
	8-Mar-21	1.5	<2.0	410	1,550	NA
	24-Nov-20	1.5	1.4	420	1,330	NA
	3-Sep-20	1.3	<2.0	400	1,380	NA
	4-Jun-20	1.3	<2.0	390	1,460	NA
	19-Feb-20	1.5	<1.0	380	1,480	NA
	2-Dec-19	1.7	<2.0	390	1,380	NA
	22-Aug-19	1.7	<2.0	390	1,330	NA
	24-May-19	1.7	<5.0	390	1,670	NA
	11-Mar-19	2.5	<1.0	380	1,280	NA
	30-Nov-18	4.9	<1.0	420	1,510	NA
	27-Aug-18	4.1	<1.0	380	1,410	NA
	4-Jun-18	5.5	<2.0	410	1,430	NA
	28-Feb-18	9.1	<1.0	360	1,440	NA
	28-Nov-17	14.5	<0.0500	457	1,540	NA
	25-Aug-17	1.14	<0.0500	100	790	NA
	9-Jun-17	15.5	<0.100	446	1,790	NA
	8-Mar-17	8.40	<0.0501	435	1,610	NA
	6-Dec-16	15.6	<0.300	443	1,710	NA
	7-Sep-16	14.8	<0.937	451	1,620	NA
	6-Jun-16	16.9	<2.24	426	1,720	NA
	29-Feb-16	10.5	<1.18	457	1,610	NA
	24-Nov-15	0.723	<1.18	146	1,560	NA
	3-Sep-15	6.53	<1.18	455	1,680	NA
	27-May-15	13.1	<1.18	490	1,550	NA
	4-Mar-15	13.9	<1.80	453	1,720	NA
	5-Dec-14	12.8	<1.80	461	1,720	NA
	3-Oct-14	12.5	<1.80	419	1,720	NA
	28-Aug-14	17.0	<1.80	445	1,740	NA
	9-Jun-14	6.86	<1.80	454	1,560	NA
	18-Mar-14	7.79	<1.66	475	1,620	NA
	16-Dec-13	8.34	4.90	475	1,600	NA
5-Sep-13	6.01	3.50	451	1,480	NA	
23-May-13	5.42	<1.66	453	1,450	NA	
6-Mar-13	4.83	<1.72	468	1,620	NA	
4-Dec-12	4.33	<1.72	434	1,510	NA	
20-Aug-12	2.86	<1.72	389	2,520	NA	
10-May-12	1.52	<1.72	361	1,400	NA	
31-Jan-12	<0.500	<2.17	433	800	NA	
26-Oct-11	3.33	2.80	384	1,150	206	
20-Jul-11	2.29	<2.17	383	1,290	NA	
20-Apr-11	1.30	<2.17	411	1,340	NA	
19-Jan-11	12.7	2.10	429	1,140	NA	
17-Sep-10	2.73	<10.0	404	1,320	NA	
29-Jun-10	1.28	<1.0	390	1,360	NA	
21-Mar-10	<2.0	<1.0	420	1,380	NA	
9-Dec-09	1.4	<1.0	460	1,360	NA	
NMED Split	9-Dec-09	1.5	<0.1	378	1,340	196
	29-Aug-09	1.2	<1.0	420	1,340	NA
	14-May-09	<2.0	<1.0	410	1,300	NA

**TABLE 4. ABATEMENT PLAN MONITORING WELL GROUNDWATER ANALYTICAL RESULTS
DONA ANA DAIRIES, DONA ANA COUNTY, NEW MEXICO**

Monitoring Well	Date Sampled	Nitrate (mg/l)	TKN (mg/l)	Chloride (mg/l)	TDS (mg/l)	Sulfate (mg/l)
DAD-20 Perched Aquifer	9-Jun-23	29	<5.0	940	2,520	NA
	10-Mar-23	30	<5.0	840	2,220	NA
	12-Dec-22	25	<5.0	630	2,050	NA
	14-Sep-22	21	<5.0	790	2,620	NA
	2-Jun-22	23	<5.0	1,000	2,730	450
	23-Mar-22	21	<5.0	730	2,300	NA
	8-Dec-21	28	<5.0	910	2,540	NA
	7-Sep-21	26	<5.0	860	2,480	NA
	28-May-21	24	<5.0	870	2,340	NA
	8-Mar-21	28	<5.0	860	2,490	NA
	7-Dec-20	26	<5.0	880	2,740	NA
	8-Sep-20	30	<5.0	960	2,730	NA
	4-Jun-20	31	<5.0	890	2,840	NA
	19-Feb-20	34	<5.0	820	2,470	NA
	2-Dec-19	36	<5.0	790	2,430	NA
	21-Aug-19	40	<2.0	780	2,500	NA
	28-May-19	37	<5.0	850	2,600	NA
	7-Mar-19	35	<5.0	900	2,530	NA
	30-Nov-18	36	<5.0	870	2,530	NA
	28-Aug-18	36	<5.0	850	2,510	NA
	1-Jun-18	35	<5.0	850	2,530	NA
	28-Feb-18	32	<5.0	710	2,390	NA
	28-Nov-17	36.6	<0.0500	891	2,350	NA
	24-Aug-17	31.4	<0.0500	760	2,310	NA
	7-Jun-17	30.6	<0.100	727	2,300	NA
	10-Mar-17	29.0	<0.0501	797	2,410	NA
	5-Dec-16	22.7	<0.300	798	2,360	NA
	7-Sep-16	22.7	<0.937	864	2,460	NA
	6-Jun-16	23.8	<2.24	784	2,420	NA
	1-Mar-16	22.5	<1.18	867	2,390	NA
	24-Nov-15	21.8	<1.18	810	2,350	NA
	2-Sep-15	21.0	<1.18	817	2,400	NA
	27-May-15	20.2	<1.18	905	2,460	NA
	4-Mar-15	20.4	<1.80	784	2,340	NA
4-Dec-14	20.8	<1.80	806	2,240	NA	
28-Aug-14	19.3	<1.80	603	2,400	NA	
9-Jun-14	20.4	<1.80	773	2,470	NA	
18-Mar-14	20.6	<1.66	665	2,120	NA	
16-Dec-13	20.2	2.10	732	2,140	NA	
5-Sep-13	19.2	5.60	808	2,870	NA	
23-May-13	25.2	<1.66	707	2,320	NA	
6-Mar-13	29.5	<1.72	710	2,280	NA	
4-Dec-12	17.0	<1.72	704	2,350	NA	
10-May-12	Obstruction in Well					
31-Jan-12	21.2	<2.17	568	1,000	NA	
7-Dec-11	16.1	<2.17	611	2,020	383	

**TABLE 4. ABATEMENT PLAN MONITORING WELL GROUNDWATER ANALYTICAL RESULTS
DONA ANA DAIRIES, DONA ANA COUNTY, NEW MEXICO**

Monitoring Well	Date Sampled	Nitrate (mg/l)	TKN (mg/l)	Chloride (mg/l)	TDS (mg/l)	Sulfate (mg/l)
DAD-21 Perched Aquifer	6-Jun-23	46	<5.0	780	2,620	NA
	9-Mar-23	24	<5.0	640	2,380	NA
	9-Dec-22	24	<5.0	640	2,300	NA
	13-Sep-22	26	<5.0	690	2,590	NA
	1-Jun-22	41	<5.0	870	2,980	NA
	22-Mar-22	41	<5.0	900	2,840	NA
	7-Dec-21	54	<5.0	1,200	2,740	NA
	3-Sep-21	64	<5.0	920	3,030	NA
	28-May-21	120	<5.0	950	3,330	NA
	8-Mar-21	110	<5.0	980	3,440	NA
	7-Dec-20	120	<5.0	990	3,610	NA
	3-Sep-20	120	<5.0	970	3,580	NA
	3-Jun-20	100	<5.0	860	3,370	NA
	19-Feb-20	110	<5.0	950	3,430	NA
	6-Dec-19	110	<5.0	770	3,200	NA
	21-Aug-19	86	<1.0	880	3,040	NA
	24-May-19	87	<5.0	860	2,920	NA
	7-Mar-19	80	<5.0	860	3,030	NA
	30-Nov-18	110	<5.0	910	3,180	NA
	27-Aug-18	90	<5.0	830	3,010	NA
	4-Jun-18	81	<5.0	750	2,900	NA
	28-Feb-18	76	<5.0	700	2,820	NA
	28-Nov-17	70.7	<0.0500	928	2,860	NA
	23-Aug-17	51.1	<0.0500	826	2,910	NA
	9-Jun-17	71.3	<0.100	977	3,360	NA
	10-Mar-17	69.2	<0.0501	939	3,190	NA
	28-Dec-16	NA	NA	NA	2,920	NA
	6-Dec-16	59.9	<0.300	936	3,020 R	NA
	7-Sep-16	58.9	<0.937	1,020	3,180	NA
	6-Jun-16	55.2	<2.24	1,350	2,920	NA
	29-Feb-16	35.6	3.92	815	2,360	NA
	23-Nov-15	6.28	<1.18	708	2,090	NA
	2-Sep-15	4.27	1.40	720	2,100	NA
	27-May-15	6.44	<1.18	609	1,910	NA
	4-Mar-15	5.95	<1.80	487	1,850	NA
	4-Dec-14	5.03	<1.80	465	1,760	NA
	28-Aug-14	13.0	<1.80	520	2,080	NA
	4-Jun-14	15.0	<1.80	532	2,180	NA
	18-Mar-14	18.1	<1.66	592	2,140	NA
	16-Dec-13	16.9	<1.66	568	1,890	NA
5-Sep-13	12.0	4.20	583	1,990	NA	
24-May-13	6.73	<1.66	509	1,960	NA	
6-Mar-13	5.76	<1.72	516	1,910	NA	
4-Dec-12	3.47	<1.72	445	1,720	NA	
20-Aug-12	3.45	<1.72	409	1,660	NA	
10-May-12	1.16	<1.72	364	2,840	NA	
31-Jan-12	6.79	2.94	475	1,620	NA	
7-Dec-11	2.14	<2.17	396	1,600	219	

**TABLE 4. ABATEMENT PLAN MONITORING WELL GROUNDWATER ANALYTICAL RESULTS
DONA ANA DAIRIES, DONA ANA COUNTY, NEW MEXICO**

Monitoring Well	Date Sampled	Nitrate (mg/l)	TKN (mg/l)	Chloride (mg/l)	TDS (mg/l)	Sulfate (mg/l)
DAD-22 Perched Aquifer	6-Jun-23	15	<2.0	870	2,360	NA
	9-Mar-23	15	<2.0	870	2,320	NA
	9-Dec-22	16	<2.0	880	2,340	NA
	14-Sep-22	15	<2.0	780	2,420	NA
	2-Jun-22	16	<2.0	880	2,440	440
	23-Mar-22	16	<2.0	780	2,440	NA
	8-Dec-21	14	<2.0	880	2,350	NA
	3-Sep-21	14	<2.0	860	2,430	NA
	28-May-21	11	<2.0	840	2,390	NA
	8-Mar-21	13	<2.0	890	2,360	NA
	7-Dec-20	12	<2.0	870	2,490	NA
	8-Sep-20	12	<2.0	850	2,410	NA
	3-Jun-20	11	<2.0	840	2,460	NA
	19-Feb-20	11	<2.0	870	2,340	NA
	6-Dec-19	6.7	<5.0	780	2,360	NA
	21-Aug-19	17	<1.0	840	2,390	NA
	24-May-19	20	<2.0	770	2,320	NA
	7-Mar-19	26	<5.0	670	2,200	NA
	30-Nov-18	18	<5.0	670	2,120	NA
	24-Aug-18	29	<5.0	700	2,380	NA
	1-Jun-18	20	<2.0	810	2,390	NA
	27-Feb-18	12	<2.0	860	2,420	NA
	28-Nov-17	16.2	<0.0500	4.03	2,250	NA
	23-Aug-17	19.0	<0.0500	803	2,410	NA
	7-Jun-17	22.2	<0.100	846	2,500	NA
	7-Mar-17	27.3	<0.300	817	2,360	NA
	5-Dec-16	25.4	<0.300	808	2,480	NA
	6-Sep-16	23.6	<0.937	863	2,380	NA
	8-Jun-16	21.8	<2.24	815	2,420	NA
	25-Feb-16	18.5	4.48	932	2,380	NA
	23-Nov-15	6.52	<1.18	964	2,340	NA
	2-Sep-15	6.35	<1.18	948	2,500	NA
	27-May-15	6.56	<1.18	920	2,520	NA
3-Mar-15	6.22	<1.80	884	2,400	NA	
3-Dec-14	6.52	<1.80	915	2,480	NA	
28-Aug-14	6.60	<1.80	810	2,420	NA	
6-Jun-14	6.80	<1.80	906	2,480	NA	
18-Mar-14	6.38	<1.66	846	2,420	NA	
13-Dec-13	6.35	<1.66	909	2,440	NA	
5-Sep-13	Did Not Contain Enough Water to Sample					
24-May-13	9.29	<1.66	920	2,580	NA	
6-Mar-13	8.25	<1.72	909	2,610	NA	
4-Dec-12	12.0	<1.72	886	2,740	NA	
20-Aug-12	15.3	2.10	878	2,280	NA	
10-May-12	18.3	<1.72	818	1,580	NA	
1-Feb-12	23.6	<2.17	908	3,000	NA	
26-Oct-11	29.5	2.52	781	3,860	494	

**TABLE 4. ABATEMENT PLAN MONITORING WELL GROUNDWATER ANALYTICAL RESULTS
DONA ANA DAIRIES, DONA ANA COUNTY, NEW MEXICO**

Monitoring Well	Date Sampled	Nitrate (mg/l)	TKN (mg/l)	Chloride (mg/l)	TDS (mg/l)	Sulfate (mg/l)
DAD-26 Perched Aquifer	6-Jun-23	22	<5.0	610	2,010	NA
	10-Mar-23	23	<5.0	720	2,070	NA
	12-Dec-22	24	<5.0	500	1,740	NA
	14-Sep-22	26	<5.0	490	1,940	NA
	2-Jun-22	26	<5.0	520	1,860	360
	23-Mar-22	22	<5.0	560	1,790	NA
	8-Dec-21	15	<2.0	470	1,610	NA
	7-Sep-21	3.8	<1.0	560	1,820	NA
	28-May-21	10	<2.0	640	2,060	NA
	8-Mar-21	6.8	<1.0	810	2,460	NA
	7-Dec-20	25	<5.0	580	2,010	NA
	8-Sep-20	38	<5.0	640	2,270	NA
	3-Jun-20	35	<5.0	640	2,320	NA
	19-Feb-20	16	<2.0	480	1,680	NA
	6-Dec-19	1.8	<5.0	300	1,060	NA
	21-Aug-19	43	<1.0	700	2,410	NA
	28-May-19	41	<5.0	730	2,360	NA
	7-Mar-19	50	<5.0	800	2,670	NA
	30-Nov-18	48	<5.0	860	2,770	NA
	28-Aug-18	110	<5.0	870	3,020	NA
	4-Jun-18	47	<5.0	920	3,240	NA
	28-Feb-18	59	<5.0	940	3,000	NA
	28-Nov-17	65.1	<0.0500	1,160	3,110	NA
	28-Aug-17	59.8	<0.0500	1,090	3,110	NA
	9-Jun-17	60.5	<0.100	1,090	3,270	NA
	10-Mar-17	66.3	<0.0501	1,110	3,280	NA
	28-Dec-16	NA	NA	NA	3,420	NA
6-Dec-16	69.6	<0.300	1,090	3,160 R	NA	
8-Sep-16	63.2	<0.937	1,030	3,210	NA	
6-Jun-16	67.0	<2.24	858	2,900	NA	
1-Mar-16	61.1	<1.18	837	2,760	NA	
22-Dec-15	59.6	<1.18	749	2,540	NA	
DAD-27 Perched Aquifer	6-Jun-23	7.0	<1.0	490	1,490	NA
	10-Mar-23	5.9	<2.0	460	1,900	NA
	12-Dec-22	6.1	<1.0	470	1,870	NA
NMWQCC Standard		10	NA	250	1,000	600
Existing Conditions - August 2020		NA	NA	455	1,424	NA
Existing Conditions - Pre-August 2020*		NA	NA	503	2,552	NA

Notes:

Data suspect

* = Pre-August 2020 existing conditions were in place prior to August 2020. This condition is no longer applicable.

NA = Not analyzed

ND = Non detect

NMWQCC = New Mexico Water Quality Control Commission

TDS = Total dissolved solids

R = Rejected. Analyzed out of hold time.

TKN = Total Kjeldahl Nitrogen

DAD-03 (6-29-10) Roots in sample may have resulted in a measured TKN result.

Data from current quarter.

Highlight is at or above NMWQCC Standard.

Highlight is at or above relevant existing conditions value. Applicable to samples collected in or after August 2020.

**TABLE 5. DISCHARGE PLAN MONITORING WELL GROUNDWATER ANALYTICAL RESULTS
DONA ANA DAIRIES, DONA ANA COUNTY, NEW MEXICO**

Monitoring Well	Date Sampled	Nitrate as N (mg/l)	TKN (mg/l)	Chloride (mg/l)	TDS (mg/l)
Northern Area					
Northern Land Application Area					
70-03	8-May-23	39	<5.0	1,500	4,640
	9-Feb-23	39	<5.0	1,800	4,140
	8-Nov-22	41	<5.0	1,900	4,690
	9-Aug-22	39	<5.0	1,600	4,750
	9-May-22	37	<5.0	1,500	4,430
	15-Feb-22	38	<5.0	1,600	4,240
	5-Nov-21	39	<5.0	1,800	4,600
	10-Aug-21	41	<5.0	1,800	4,770
	10-May-21	40	<5.0	1,800	4,760
	16-Feb-21	41	<5.0	1,700	4,600
	11-Nov-20	43	<5.0	1,900	5,050
	14-Aug-20	47	<5.0	2,100	5,590
	13-May-20	50	<5.0	2,200	5,810
	7-Feb-20	50	<1.0	2,400	6,080
	15-Nov-19	48	<5.0	2,200	6,350
	6-Aug-19	53	<2.0	2,800	6,810
	16-May-19	50	<5.0	3,100	6,850
	26-Feb-19	51	<5.0	3,000	7,320
	15-Nov-18	52	<5.0	3,300	7,530
	15-Aug-18	50	<5.0	3,100	7,900
	21-May-18	50	<5.0	3,200	8,080
	13-Feb-18	46	<5.0	3,400	8,490
	9-Nov-17	44.7	1.26	3,320	7,940
	14-Aug-17	45.4	1.89	3,380	8,370
	19-May-17	43.5	0.539	3,330	8,370
	20-Feb-17	43.6	<0.0501	3,200	8,270
	22-Nov-16	43.4	<0.300	3,250	8,430
	18-Aug-16	45.2	<0.937	6,010	9,340
	24-May-16	47.4	<2.24	3,220	8,330
	16-Feb-16	49.1	<1.18	3,340	8,380
	12-Nov-15	46.9	4.48	2,850	7,040
	19-Aug-15	47.4	<1.18	2,510	6,760
	12-May-15	47.0	1.40	3,060	7,900
	10-Feb-15	34.8	<1.80	744	6,140
	14-Nov-14	49.1	<1.80	2,530	6,360
	20-Aug-14	49.8	<1.80	2,590	7,000
	15-May-14	48.6	<1.80	2,580	6,880
	19-Feb-14	57.1	<1.66	3,400	8,380
	14-Nov-13	45.4	3.50	2,680	6,800
	9-Aug-13	48.7	3.50	2,740	6,890
9-May-13	58.4	<1.66	3,290	9,200	
13-Feb-13	59.1	<1.72	3,400	8,440	
7-Nov-12	49.5	<1.72	2,850	7,950	
7-Aug-12	45.3	2.94	2,440	6,700	
25-Apr-12	53.1	5.60	2,540	6,550	
2-Feb-12	67.6	<2.17	2,840	7,480	
7-Nov-11	61.6	<2.17	3,270	7,910	
3-Aug-11	63.1	2.80	3,140	8,040	
21-Apr-11	58.9	<2.17	3,130	8,040	
27-Jan-11	71.2	3.36	3,140	7,580	
22-Sep-10	62.8	<10.0	2,940	7,840	
30-Jun-10	57	<1.0	2,200	5,720	
26-Mar-10	29.6	ND	2,160	5,180	
15-Dec-09	27.1	ND	2,199	5,462	
2-Sep-09	25.4	ND	2,149	5,570	
4-Jun-09	18.6	ND	1,999	5,518	
4-Mar-09	35.5	ND	2,074	5,418	

**TABLE 5. DISCHARGE PLAN MONITORING WELL GROUNDWATER ANALYTICAL RESULTS
DONA ANA DAIRIES, DONA ANA COUNTY, NEW MEXICO**

Monitoring Well	Date Sampled	Nitrate as N (mg/l)	TKN (mg/l)	Chloride (mg/l)	TDS (mg/l)
70/86/340-01	5-May-23	24	<5.0	1,900	6,060
	8-Feb-23	29	<5.0	2,000	6,560
	7-Nov-22	27	<5.0	1,800	6,570
	8-Aug-22	20	<5.0	1,900	6,250
	5-May-22	20	<5.0	1,900	6,120
	14-Feb-22	20	<5.0	1,700	5,440
	4-Nov-21	20	<5.0	1,500	4,260
	9-Aug-21	3.9	<1.0	1,000	3,060
	6-May-21	7.9	<1.0	1,300	3,550
	15-Feb-21	9.8	<1.0	1,500	3,790
	11-Nov-20	12	<2.0	1,700	4,320
	13-Aug-20	18	<1.0	1,600	4,500
	18-May-20	18	<2.0	1,800	4,520
	7-Feb-20	22	<5.0	1,700	4,590
	15-Nov-19	22	<1.0	1,500	4,660
	7-Aug-19	23	<5.0	1,700	4,720
	16-May-19	23	<5.0	1,800	4,720
	25-Feb-19	21	<5.0	1,700	4,750
	16-Nov-18	23	<5.0	1,700	4,560
	14-Aug-18	19	<2.0	1,700	4,680
	21-May-18	18	<2.0	1,600	4,600
	12-Feb-18	19	<2.0	1,500	4,580
	9-Nov-17	19.6	0.750	1,510	4,190
	11-Aug-17	20.6	0.868	1,790	5,170
	18-May-17	20.3	0.665	1,730	5,410
	16-Feb-17	30.1	<0.0501	1,350	4,430
	10-Nov-16	22.6	1.14	817	5,080
	23-Aug-16	24.1	<0.937	3,450	5,170
	19-May-16	17.3	6.92	1,630	4,680
	15-Feb-16	12.1	<1.18	1,750	4,730
	10-Nov-15	16.0	<1.18	1,740	4,940
	20-Aug-15	8.66	2.80	1,790	4,860
	11-May-15	8.19	<1.18	1,780	4,780
	9-Feb-15	8.79	<1.80	1,620	4,840
	12-Nov-14	15.6	<1.80	2,090	6,320
	15-Aug-14	15.3	<1.80	1,730	5,780
	11-Nov-13	6.65	4.90	1,760	4,780
	8-Aug-13	15.1	3.50	2,190	6,920
	9-May-13	15.1	<1.66	1,930	6,650
	13-Feb-13	16.6	<1.72	2,170	6,660
	5-Nov-12	12.7	<1.72	2,120	4,940
	6-Aug-12	17.1	<1.72	1,870	6,400
	25-Apr-12	11.8	<1.72	1,620	4,280
	2-Feb-12	20.0	8.12	1,750	5,440
	7-Nov-11	25.5	4.76	1,970	5,920
	25-Jul-11	31.0	2.24	1,800	5,500
	21-Apr-11	35.0	<2.17	1,780	5,420
	27-Jan-11	53.5	<2.17	1,370	4,420
	22-Sep-10	39.8	<10.0	1,130	4,000
	30-Jun-10	52	<1.0	1,300	4,090
	26-Mar-10	53	ND	1,200	3,616
	15-Dec-09	64	ND	1,080	3,408
	2-Sep-09	50	ND	1,100	3,610
	4-Jun-09	28	ND	1,410	4,340
	4-Mar-09	39.3	ND	1,150	3,820

**TABLE 5. DISCHARGE PLAN MONITORING WELL GROUNDWATER ANALYTICAL RESULTS
DONA ANA DAIRIES, DONA ANA COUNTY, NEW MEXICO**

Monitoring Well	Date Sampled	Nitrate as N (mg/l)	TKN (mg/l)	Chloride (mg/l)	TDS (mg/l)
86/340-01	5-May-23	2.9	<1.0	270	2,220
	8-Feb-23	3.2	<1.0	260	2,210
	7-Nov-22	2.9	<1.0	230	2,190
	8-Aug-22	3.4	<1.0	240	2,190
	5-May-22	3.1	<1.0	220	2,150
	14-Feb-22	3.2	<1.0	230	2,170
	4-Nov-21	3.1	<1.0	260	2,190
	9-Aug-21	2.8	<1.0	240	2,190
	6-May-21	3.2	<1.0	230	1,890
	15-Feb-21	2.9	<5.0	240	2,120
	11-Nov-20	3.4	<1.0	200	2,080
	13-Aug-20	3.6	<2.0	220	2,030
	18-May-20	5.1	<1.0	250	2,010
	7-Feb-20	4.7	<1.0	230	1,990
	15-Nov-19	5.0	<1.0	210	2,010
	7-Aug-19	5.9	<1.0	240	1,940
	16-May-19	7.5	<1.0	260	1,930
	25-Feb-19	7.0	<1.0	250	1,910
	16-Nov-18	7.0	<1.0	240	1,900
	14-Aug-18	7.4	<1.0	230	1,890
	21-May-18	8.3	<1.0	240	1,890
	12-Feb-18	9.6	<1.0	300	1,920
	9-Nov-17	10.5	<0.0500	293	1,670
	11-Aug-17	11.9	<0.0500	338	2,030
	18-May-17	13.4	<0.0501	445	2,410
	16-Feb-17	13.1	<0.0501	387	2,240
	10-Nov-16	11.6	<0.937	384	2,200
	23-Aug-16	12.1	<0.937	408	2,210
	19-May-16	11.2	<2.24	421	2,220
	15-Feb-16	12.9	<1.18	422	2,300
	10-Nov-15	11.7	2.24	421	2,260
	20-Aug-15	11.7	<1.18	416	2,150
	11-May-15	12.4	<1.18	450	2,240
	9-Feb-15	10.8	<1.80	410	2,120
	11-Nov-14	11.3	<1.80	398	2,180
	15-Aug-14	11.6	<1.80	400	2,300
	14-May-14	15.4	<1.80	500	2,380
	18-Feb-14	12.4	<1.66	460	2,370
	11-Nov-13	12.2	7.00	641	2,940
	8-Aug-13	12.1	2.10	720	3,230
	9-May-13	12.3	<1.66	603	3,020
	13-Feb-13	12.2	<1.72	571	2,780
	5-Nov-12	12.1	<1.72	638	2,860
	6-Aug-12	11.6	<1.72	708	3,410
	25-Apr-12	12.1	<1.72	641	2,480
	2-Feb-12	12.3	<2.17	655	2,960
	7-Nov-11	11.6	3.08	593	2,910
	25-Jul-11	10.2	<2.17	582	2,500
	21-Apr-11	10.4	<2.17	512	2,660
	27-Jan-11	7.99	<2.17	419	2,040
	22-Sep-10	11.8	<10.0	331	2,060
	30-Jun-10	13	<1.0	410	2,190
	26-Mar-10	9.2	0.7	690	2,656
	29-Jan-10	8.6	ND	530	2,258
	2-Sep-09	8.8	ND	510	2,232
	4-Jun-09	5.2	1.12	640	2,582
	4-Mar-09	11.9	ND	675	2,674

**TABLE 5. DISCHARGE PLAN MONITORING WELL GROUNDWATER ANALYTICAL RESULTS
DONA ANA DAIRIES, DONA ANA COUNTY, NEW MEXICO**

Monitoring Well	Date Sampled	Nitrate as N (mg/l)	TKN (mg/l)	Chloride (mg/l)	TDS (mg/l)
Organ Dairy (Formerly known as Del Norte Dairy and Daybreak Dairy)					
126-04	24-May-23	Not Sampled - insufficient water to sample			
	11-Jan-23				
	8-Nov-22				
	17-Aug-22				
	5-May-22	25	<5.0	750	3,130
	24-Feb-22	23	<5.0	770	3,110
	9-Nov-21	25	<5.0	810	1,530
	11-Aug-21	28	<5.0	800	2,930
	4-May-21	26	<5.0	790	3,170
	9-Feb-21	27	<5.0	760	3,200
	10-Nov-20	28	<5.0	780	3,120
	12-Aug-20	29	<5.0	790	2,980
	13-May-20	25	<5.0	680	2,620
	10-Feb-20	25	<5.0	680	2,580
	12-Nov-19	26	<5.0	670	2,600
	5-Aug-19	23	<5.0	620	2,420
	14-May-19	22	<5.0	630	2,400
	22-Feb-19	24	<5.0	650	2,370
	14-Nov-18	23	<5.0	610	2,530
	15-Aug-18	19	<2.0	580	2,400
	18-May-18	21	<5.0	570	2,360
	9-Feb-18	22	<2.0	620	2,530
	8-Nov-17	22.1	<0.0500	661	2,510
	10-Aug-17	19.4	0.871	614	2,550
	17-May-17	19.7	0.356	606	2,600
	17-Feb-17	20.7	<0.0501	639	2,680
	9-Nov-16	18.5	<0.937	621	2,580
	17-Aug-16	16.1	1.12	516	2,560
	18-May-16	16.7	<2.24	580	2,460
	15-Feb-16	20.2	4.48	623	2,510
	9-Nov-15	19.2	<1.18	612	2,460
	17-Aug-15	18.4	<1.18	573	2,490
	13-May-15	17.9	4.20	575	2,560
11-Feb-15	17.1	<1.80	572	2,450	
12-Nov-14	16.4	7.70	556	2,400	
18-Aug-14	15.1	<1.80	536	2,590	
15-May-14	17.4	16.1	514	2,200	
20-Feb-14	17.1	<1.66	564	2,410	
13-Nov-13	16.7	9.10	567	2,240	
12-Aug-13	15.3	18.2	511	2,170	
10-May-13	15.1	<1.66	499	2,310	
12-Feb-13	18.5	<1.72	614	2,640	
7-Nov-12	16.0	3.50	572	2,500	
7-Aug-12	15.9	2.10	568	2,370	
30-Apr-12	15.7	<1.72	539	2,310	
26-Jan-12	17.4	<2.17	560	1,700	
7-Nov-11	18.2	3.92	581	2,470	
3-Aug-11	18.2	6.44	559	2,460	
22-Apr-11	18.0	5.74	594	2,500	
26-Jan-11	11.1	<2.17	570	2,380	
21-Sep-10	20.5	<10.0	542	2,460	
30-Jun-10	21	<5.0	490	2,160	
25-Mar-10	14.9	0.56	530	1,964	
15-Dec-09	11.5	ND	550	1,974	
2-Sep-09	9	ND	530	2,028	
4-Jun-09	5.81	ND	550	2,084	
5-Mar-09	14.1	ND	525	2,122	

**TABLE 5. DISCHARGE PLAN MONITORING WELL GROUNDWATER ANALYTICAL RESULTS
DONA ANA DAIRIES, DONA ANA COUNTY, NEW MEXICO**

Monitoring Well	Date Sampled	Nitrate as N (mg/l)	TKN (mg/l)	Chloride (mg/l)	TDS (mg/l)
126-05	24-May-23	Not Sampled - insufficient water to sample			
	11-Jan-23				
	8-Nov-22				
	17-Aug-22				
5-May-22	9.0	1.3	660	3,220	
24-Feb-22	10	<2.0	710	3,270	
9-Nov-21	11	<2.0	750	3,380	
11-Aug-21	11	<2.0	790	3,480	
4-May-21	11	<2.0	730	3,380	
9-Feb-21	13	<2.0	780	3,710	
10-Nov-20	14	<2.0	1,000	3,670	
12-Aug-20	15	<2.0	740	3,220	
13-May-20	10	2.20	820	3,590	
10-Feb-20	13	<2.0	900	3,800	
12-Nov-19	15	<2.0	930	3,860	
5-Aug-19	16	<2.0	750	3,490	
14-May-19	17	<2.0	800	3,520	
22-Feb-19	18	<2.0	950	3,810	
14-Nov-18	20	<5.0	890	3,840	
15-Aug-18	23	<5.0	860	3,590	
18-May-18	23	<5.0	840	3,790	
9-Feb-18	26	<2.0	960	3,800	
8-Nov-17	26.6	0.196	860	3,510	
10-Aug-17	25.4	2.17	814	3,460	
17-May-17	28.1	1.20	856	3,600	
17-Feb-17	28.5	4.95	852	3,580	
9-Nov-16	41.9	<0.937	769	3,510	
18-Aug-16	20.5	<0.937	572	3,120	
18-May-16	24.2	<2.24	728	3,130	
15-Feb-16	27.7	1.68	792	3,190	
9-Nov-15	20.2	<1.18	643	2,980	
17-Aug-15	18.8	<1.18	627	2,860	
12-May-15	17.6	2.10	670	3,000	
11-Feb-15	28.8	<1.80	713	3,470	
12-Nov-14	19.2	5.60	746	3,500	
18-Aug-14	16.4	<1.80	575	3,080	
15-May-14	23.0	4.90	637	2,960	
20-Feb-14	27.1	<1.66	643	3,140	
13-Nov-13	30.3	4.20	648	3,100	
12-Aug-13	33.9	4.20	594	2,920	
10-May-13	39.0	<1.66	635	3,060	
12-Feb-13	34.2	<1.72	618	3,180	
7-Nov-12	29.2	<1.72	548	2,890	
7-Aug-12	30.8	2.10	548	2,860	
30-Apr-12	28.6	2.38	530	2,840	
26-Jan-12	30.1	<2.17	546	2,520	
4-Nov-11	31.2	<2.17	543	3,510	
4-Aug-11	29.5	4.20	525	2,540	
22-Apr-11	28.0	2.80	615	2,800	
26-Jan-11	25.2	3.64	553	2,870	
21-Sep-10	22.3	<10.0	504	2,240	
30-Jun-10	24	<5.0	540	2,750	
25-Mar-10	13.5	ND	640	2,736	
15-Dec-09	16.6	ND	630	2,554	
2-Sep-09	12.8	1.4	580	2,566	
4-Jun-09	10.1	ND	600	2,640	
5-Mar-09	19.9	1.03	610	2,828	

**TABLE 5. DISCHARGE PLAN MONITORING WELL GROUNDWATER ANALYTICAL RESULTS
DONA ANA DAIRIES, DONA ANA COUNTY, NEW MEXICO**

Monitoring Well	Date Sampled	Nitrate as N (mg/l)	TKN (mg/l)	Chloride (mg/l)	TDS (mg/l)
126-07	24-May-23	Not Sampled - insufficient water to sample			
	11-Jan-23				
	8-Nov-22				
	17-Aug-22				
5-May-22	21	<5.0	790	3,470	
24-Feb-22	22	<5.0	870	3,550	
9-Nov-21	22	<5.0	910	3,480	
11-Aug-21	23	<5.0	890	3,430	
4-May-21	22	<5.0	790	3,390	
9-Feb-21	25	<5.0	770	3,400	
10-Nov-20	26	<5.0	860	3,340	
12-Aug-20	28	<5.0	830	3,310	
13-May-20	25	<5.0	780	3,290	
7-Feb-20	28	<5.0	780	3,230	
12-Nov-19	28	<5.0	770	3,150	
5-Aug-19	29	<5.0	800	3,150	
14-May-19	28	<5.0	790	3,110	
22-Feb-19	30	<5.0	790	3,030	
14-Nov-18	27	<5.0	790	2,990	
15-Aug-18	22	<1.0	720	2,900	
18-May-18	22	<5.0	660	2,740	
9-Feb-18	21	<2.0	690	2,760	
8-Nov-17	22.4	<0.0500	701	2,630	
10-Aug-17	21.6	<0.0500	723	2,540	
17-May-17	22.3	<0.0501	702	2,510	
17-Feb-17	23.9	<0.0501	663	2,590	
9-Nov-16	27.2	<0.937	526	2,540	
18-Aug-16	28.2	<0.937	523	2,510	
18-May-16	28.5	<2.24	607	2,380	
15-Feb-16	27.0	<1.18	579	2,460	
9-Nov-15	26.5	6.16	571	2,380	
17-Aug-15	23.0	<1.18	559	2,610	
13-May-15	17.9	4.20	575	2,560	
11-Feb-15	24.0	<1.80	546	2,590	
12-Nov-14	23.4	<1.80	586	2,710	
18-Aug-14	21.8	<1.80	565	2,510	
16-May-14	24.8	4.90	583	2,170	
20-Feb-14	25.6	<1.66	615	2,490	
13-Nov-13	24.1	4.20	615	2,330	
12-Aug-13	23.5	5.60	586	2,410	
10-May-13	20.2	<1.66	573	2,620	
12-Feb-13	21.2	<1.72	648	2,740	
7-Nov-12	19.8	<1.72	629	2,870	
7-Aug-12	19.5	2.10	650	2,610	
30-Apr-12	18.8	<1.72	605	2,710	
26-Jan-12	18.8	2.24	666	2,790	
4-Nov-11	19.8	<2.17	668	2,270	
4-Aug-11	19.1	2.24	666	1,410	
22-Apr-11	21.2	<2.17	704	3,110	
27-Jan-11	22.4	<2.17	662	2,670	
21-Sep-10	24.9	<10.0	700	2,800	
30-Jun-10	26	<5.0	760	2,780	
25-Mar-10	12.1	ND	610	2,238	
15-Dec-09	13.8	ND	720	2,412	
2-Sep-09	10.9	ND	820	2,716	
4-Jun-09	19.0	ND	810	2,468	
5-Mar-09	16.8	ND	605	2,230	

**TABLE 5. DISCHARGE PLAN MONITORING WELL GROUNDWATER ANALYTICAL RESULTS
DONA ANA DAIRIES, DONA ANA COUNTY, NEW MEXICO**

Monitoring Well	Date Sampled	Nitrate as N (mg/l)	TKN (mg/l)	Chloride (mg/l)	TDS (mg/l)
126-09	24-May-23	Not Sampled - insufficient water to sample			
	11-Jan-23				
	8-Nov-22				
	17-Aug-22				
	5-May-22	1.4	<1.0	190	924
	24-Feb-22	1.0	<1.0	150	856
	9-Nov-21	Not Sampled - insufficient water to sample			
	11-Aug-21				
	4-May-21				
	9-Feb-21				
	10-Nov-20	1.2	<1.0	200	865
	12-Aug-20	Not Sampled - insufficient water to sample			
	14-May-20				
	7-Feb-20				
	12-Nov-19	<1.0	<1.0	150	824
	5-Aug-19	1.1	<2.0	200	898
	14-May-19	<1.0	<2.0	160	815
	22-Feb-19	<1.0	<1.0	200	888
	14-Nov-18	<1.0	<1.0	140	764
	15-Aug-18	<1.0	<1.0	110	722
	18-May-18	<1.0	<1.0	150	742
	9-Feb-18	<1.0	<1.0	120	732
	8-Nov-17	1.65	0.538	66.7	555
	10-Aug-17	0.218	0.452	70.0	740
	17-May-17	0.230	<0.0501	67.1	640
	20-Feb-17	0.269	1.80	89.5	775
	9-Nov-16	2.39	<0.937	824	2,440
	18-Aug-16	1.41	2.25	714	2,500
	18-May-16	6.35	<2.24	794	2,440
	15-Feb-16	1.73	<1.18	879	2,660
	9-Nov-15	1.47	6.16	879	2,860
	17-Aug-15	1.40	<1.18	880	2,850
	13-May-15	2.34	<1.18	873	2,500
	11-Feb-15	2.18	<1.80	798	2,740
	13-Nov-14	2.42	<1.80	842	2,500
	18-Aug-14	2.25	<1.80	832	2,840
	15-May-14	2.52	<1.80	893	2,690
	20-Feb-14	2.12	<1.66	911	2,720
	13-Nov-13	2.25	4.20	919	2,710
	12-Aug-13	2.13	5.60	937	2,710
	10-May-13	2.25	<1.66	898	3,300
	12-Feb-13	2.50	<1.72	991	3,090
7-Nov-12	2.53	<1.72	984	2,980	
7-Aug-12	2.69	2.10	962	3,050	
30-Apr-12	2.28	5.04	978	2,900	
26-Jan-12	3.93	7.00	1,100	3,180	
7-Nov-11	3.30	5.6	1,130	3,470	
4-Aug-11	3.19	<2.17	1,100	3,180	
22-Apr-11	3.31	<2.17	1,120	2,730	
22-Sep-10	2.50	<10.0	1,110	3,320	
30-Jun-10	Not Sampled				
25-Mar-10					
15-Dec-09					
2-Sep-09					
4-Jun-09					
5-Mar-09					

**TABLE 5. DISCHARGE PLAN MONITORING WELL GROUNDWATER ANALYTICAL RESULTS
DONA ANA DAIRIES, DONA ANA COUNTY, NEW MEXICO**

Monitoring Well	Date Sampled	Nitrate as N (mg/l)	TKN (mg/l)	Chloride (mg/l)	TDS (mg/l)
126-12	24-May-23	3.2	1.4	400	2,110
	11-Jan-23	4.3	<1.0	420	2,210
	8-Nov-22	3.4	<1.0	430	2,160
	17-Aug-22	3.8	<1.0	410	2,200
	5-May-22	3.8	<1.0	360	2,120
	24-Feb-22	4.6	<1.0	420	2,180
	9-Nov-21	4.6	<1.0	390	2,120
	11-Aug-21	6.7	<1.0	430	2,170
	4-May-21	6.9	<1.0	370	2,220
	9-Feb-21	6.0	<1.0	350	2,220
	10-Nov-20	8.9	<1.0	400	2,240
	12-Aug-20	11	<2.0	420	2,350
	12-Aug-20	11	<2.0	420	2,260
	14-May-20	6.4	<1.0	350	2,190
	10-Feb-20	2.8	<1.0	310	2,100
	12-Nov-19	8.3	<1.0	350	2,200
	5-Aug-19	13	<2.0	370	2,270
	14-May-19	8.1	<2.0	350	2,180
	22-Feb-19	8.2	1.3	370	2,270
	14-Nov-18	13	<2.0	390	2,300
	15-Aug-18	17	2.5	430	2,500
	7-Jun-18	11	2.2	420	2,550
	9-Feb-18	3.9	4.5	420	2,430
	8-Nov-17	3.26	16.6	24.5	2,440
	10-Aug-17	7.40	4.90	520	2,780
	17-May-17	17.6	0.476	455	2,480
	20-Feb-17	13.0	1.09	420	2,430
	9-Nov-16	17.1	<0.937	430	2,520
	18-Aug-16	19.4	<0.937	363	2,580
	18-May-16	17.6	<2.24	391	2,310
	15-Feb-16	13.9	<1.18	416	2,450
	9-Nov-15	10.8	8.96	428	2,460
	17-Aug-15	3.49	10.5	407	2,240
	12-May-15	2.43	11.2	393	2,120
	10-Feb-15	<0.0137	29.4	632	2,190
	13-Nov-14	2.57	2.80	409	2,160
	18-Aug-14	16.5	<1.80	384	2,220
	15-May-14	15.4	2.10	404	2,250
	20-Feb-14	13.6	2.10	404	2,370
	13-Nov-13	15.7	3.50	401	2,360
	12-Aug-13	17.0	4.20	434	2,400
	10-May-13	16.2	2.10	398	2,380
12-Feb-13	18.8	<1.72	421	2,480	
7-Nov-12	19.2	<1.72	407	2,490	
7-Aug-12	17.5	<1.72	410	2,460	
30-Apr-12	12.9	1.96	401	2,270	
14-Feb-12	12.5	4.20	418	2,340	
4-Nov-11	13.3	<2.17	430	2,600	
4-Aug-11	13.6	<2.17	449	2,580	
22-Apr-11	13.2	<2.17	461	2,530	
27-Jan-11	12.2	<2.17	453	2,280	
22-Sep-10	12.6	<10.0	446	2,430	
30-Jun-10	15	<2.0	500	2,610	
25-Mar-10	8.9	ND	550	2,260	
15-Dec-09	8.7	ND	540	2,296	
2-Sep-09	12.8	0.56	530	2,336	
4-Jun-09	4.08	0.84	530	2,322	
5-Mar-09	11	ND	475	2,320	

**TABLE 5. DISCHARGE PLAN MONITORING WELL GROUNDWATER ANALYTICAL RESULTS
DONA ANA DAIRIES, DONA ANA COUNTY, NEW MEXICO**

Monitoring Well	Date Sampled	Nitrate as N (mg/l)	TKN (mg/l)	Chloride (mg/l)	TDS (mg/l)
126-13	24-May-23	14	<2.0	710	3,160
	11-Jan-23	14	<2.0	700	1,600
	8-Nov-22	14	<2.0	720	3,210
	17-Aug-22	14	<2.0	690	3,210
	5-May-22	14	<2.0	700	3,330
	24-Feb-22	15	<2.0	760	3,380
	9-Nov-21	16	<2.0	780	3,320
	11-Aug-21	18	<2.0	830	3,360
	4-May-21	17	<2.0	780	3,420
	9-Feb-21	19	<2.0	740	3,440
	10-Nov-20	20	<2.0	780	3,390
	12-Aug-20	23	<5.0	860	3,520
	13-May-20	26	<5.0	860	3,860
	7-Feb-20	34	<5.0	880	3,640
	12-Nov-19	32	<5.0	830	3,730
	5-Aug-19	32	<5.0	900	3,790
	14-May-19	36	<5.0	970	3,570
	22-Feb-19	39	<5.0	990	3,620
	14-Nov-18	42	<5.0	950	3,420
	15-Aug-18	40	<5.0	890	3,670
	18-May-18	37	<5.0	890	3,250
	9-Feb-18	31	<2.0	820	3,330
	8-Nov-17	28.6	0.580	771	2,810
	10-Aug-17	24.4	0.153	784	3,080
	17-May-17	23.2	<0.0501	796	3,180
	17-Feb-17	23.8	<0.0501	869	3,920
	9-Nov-16	23.2	<0.937	594	3,090
	18-Aug-16	23.4	<0.937	703	3,090
	18-May-16	26.1	<2.24	799	3,000
	15-Feb-16	36.9	<1.18	891	2,960
	9-Nov-15	29.6	<1.18	760	2,850
	17-Aug-15	33.3	<1.18	876	3,100
	12-May-15	40.8	1.40	877	3,210
	10-Feb-15	34.7	2.80	776	2,770
	12-Nov-14	33.9	<1.80	801	2,940
	18-Aug-14	38.2	<1.80	809	3,160
	15-May-14	49.5	<1.80	841	3,010
	20-Feb-14	29.9	<1.66	769	2,780
	13-Nov-13	28.0	2.80	655	2,980
	12-Aug-13	26.8	3.50	780	2,800
	10-May-13	34.1	<1.66	385	3,160
	12-Feb-13	33.7	<1.72	735	2,840
	7-Nov-12	23.8	2.10	751	3,090
7-Aug-12	26.1	2.10	779	2,860	
30-Apr-12	43.8	<1.72	784	3,120	
26-Jan-12	27.5	<2.17	735	2,800	
7-Nov-11	21.9	<2.17	735	3,060	
4-Aug-11	21.4	<2.17	735	2,840	
22-Apr-11	21.7	<2.17	754	2,640	
26-Jan-11	22.8	<2.17	768	3,130	
22-Sep-10	23.1	<10.0	750	2,850	
30-Jun-10	26	<5.0	810	3,000	
25-Mar-10	10.3	ND	940	2,740	
15-Dec-09	14.3	ND	910	2,832	
2-Sep-09	12.8	ND	840	2,746	
4-Jun-09	16.3	ND	970	2,768	
5-Mar-09	19.4	ND	845	2,800	

**TABLE 5. DISCHARGE PLAN MONITORING WELL GROUNDWATER ANALYTICAL RESULTS
DONA ANA DAIRIES, DONA ANA COUNTY, NEW MEXICO**

Monitoring Well	Date Sampled	Nitrate as N (mg/l)	TKN (mg/l)	Chloride (mg/l)	TDS (mg/l)
Mountain View Dairy					
70-01	8-May-23	13	<2.0	770	3,100
	9-Feb-23	17	<2.0	720	3,160
	8-Nov-22	17	2.2	700	3,180
	9-Aug-22	16	<2.0	690	3,350
	9-May-22	15	<2.0	700	3,330
	15-Feb-22	20	<5.0	690	3,170
	5-Nov-21	20	<5.0	850	3,320
	10-Aug-21	23	<5.0	750	3,130
	10-May-21	22	<5.0	750	3,180
	16-Feb-21	23	<5.0	800	3,140
	12-Nov-20	26	<5.0	720	3,030
	14-Aug-20	27	<5.0	770	3,150
	13-May-20	27	<5.0	710	3,000
	10-Feb-20	28	<5.0	770	3,210
	15-Nov-19	29	<5.0	770	3,460
	7-Aug-19	31	<5.0	850	3,450
	16-May-19	34	<5.0	850	3,370
	26-Feb-19	33	<5.0	840	3,390
	15-Nov-18	32	<5.0	770	3,080
	15-Aug-18	37	<5.0	900	3,530
	21-May-18	39	<5.0	860	3,410
	13-Feb-18	30	<5.0	810	3,010
	9-Nov-17	25.6	0.113	687	2,620
	14-Aug-17	24.3	0.290	723	2,740
	19-May-17	22.4	<0.0501	660	2,540
	20-Feb-17	21.8	<0.0501	643	2,530
	22-Nov-16	20.8	<0.300	696	2,790
	19-Aug-16	23.5	<0.937	532	2,740
	24-May-16	22.8	<2.24	629	2,720
	16-Feb-16	25.6	1.68	673	2,650
	12-Nov-15	26.0	5.04	630	2,560
	19-Aug-15	34.5	5.60	812	2,660
	12-May-15	23.2	9.10	597	2,520
	10-Feb-15	22.5	10.5	594	2,560
	17-Nov-14	22.0	<1.80	621	2,620
	20-Aug-14	22.5	<1.80	596	2,610
	15-May-14	23.3	2.10	632	2,540
	19-Feb-14	22.6	<1.66	616	2,620
	14-Nov-13	22.3	3.50	510	2,620
	8-Aug-13	22.8	2.80	638	2,670
9-May-13	22.4	<1.66	616	2,740	
13-Feb-13	24.7	<1.72	655	2,680	
7-Nov-12	21.2	<1.72	636	2,700	
7-Aug-12	21.4	2.10	637	2,700	
25-Apr-12	21.7	<1.72	659	2,490	
2-Feb-12	21.5	2.94	633	2,530	
7-Nov-11	21.1	5.18	622	1,860	
3-Aug-11	20.7	2.8	641	2,630	
22-Apr-11	22.7	22.4	646	2,760	
27-Jan-11	22.5	2.94	650	2,500	
22-Sep-10	19.3	12.3	617	2,610	
30-Jun-10	27	<1.0	600	2,400	
25-Mar-10	14.5	ND	670	2,096	
15-Dec-09	17.1	ND	640	2,218	
1-Sep-09	8.4	ND	630	2,244	
2-Jun-09	9.35	ND	640	2,112	
4-Mar-09	20.8	ND	610	2,254	

**TABLE 5. DISCHARGE PLAN MONITORING WELL GROUNDWATER ANALYTICAL RESULTS
DONA ANA DAIRIES, DONA ANA COUNTY, NEW MEXICO**

Monitoring Well	Date Sampled	Nitrate as N (mg/l)	TKN (mg/l)	Chloride (mg/l)	TDS (mg/l)
70-02	8-May-23	29	<5.0	740	2,890
	9-Feb-23	32	<5.0	920	2,920
	8-Nov-22	31	<5.0	830	2,840
	9-Aug-22	33	<5.0	740	2,980
	9-May-22	33	<5.0	760	3,020
	15-Feb-22	34	<5.0	860	2,980
	5-Nov-21	35	<5.0	780	2,990
	10-Aug-21	34	<5.0	810	2,990
	10-May-21	33	<5.0	770	2,980
	16-Feb-21	34	<5.0	790	3,020
	12-Nov-20	35	<5.0	770	2,870
	14-Aug-20	34	<5.0	800	3,040
	13-May-20	34	<5.0	810	3,070
	10-Feb-20	33	<5.0	810	2,980
	12-Nov-19	33	<5.0	780	2,930
	6-Aug-19	35	<2.0	830	2,980
	16-May-19	36	<5.0	840	2,960
	26-Feb-19	32	<5.0	780	3,030
	14-Nov-18	31	<5.0	880	2,950
	15-Aug-18	34	<5.0	800	3,140
	21-May-18	33	<5.0	790	2,960
	13-Feb-18	29	<5.0	850	3,060
	9-Nov-17	30.7	<0.0500	770	2,680
	14-Aug-17	33.4	0.675	824	3,220
	19-May-17	31.3	<0.0501	791	3,070
	20-Feb-17	31.0	<0.0501	808	3,120
	22-Nov-16	31.3	1.82	831	3,150
	18-Aug-16	35.0	<0.937	849	3,270
	23-May-16	35.9	<2.24	801	3,250
	16-Feb-16	37.7	<1.18	837	3,180
	12-Nov-15	36.1	8.40	811	3,210
	19-Aug-15	35.7	<1.18	761	3,320
	12-May-15	36.3	3.50	791	3,810
	10-Feb-15	37.6	<1.80	770	3,200
	17-Nov-14	37.4	<1.80	793	3,180
	20-Aug-14	35.8	<1.80	766	3,160
	14-May-14	37.0	<1.80	781	3,220
	19-Feb-14	36.9	<1.66	793	3,160
	14-Nov-13	36.1	4.90	837	3,200
	9-Aug-13	20.9	29.4	815	2,890
	9-May-13	37.4	<1.66	790	3,260
	13-Feb-13	38.1	<1.72	841	3,160
	7-Nov-12	36.2	<1.72	820	3,300
	7-Aug-12	36.3	3.78	826	3,260
	25-Apr-12	37.9	<1.72	749	2,260
	2-Feb-12	37.5	<2.17	829	3,160
	7-Nov-11	37.7	<2.17	828	2,790
	4-Aug-11	36.8	5.04	798	3,160
	22-Apr-11	38.1	8.40	836	3,220
	27-Jan-11	44.2	6.02	863	3,390
	22-Sep-10	32.2	<10.0	829	3,070
	30-Jun-10	46	< 1.0	860	3,170
	25-Mar-10	19.6	ND	930	3,076
	15-Dec-09	18.3	ND	960	3,012
	1-Sep-09	21.4	ND	970	3,148
	2-Jun-09	17.8	ND	920	3,084
	4-Mar-09	35.8	ND	940	3,104

**TABLE 5. DISCHARGE PLAN MONITORING WELL GROUNDWATER ANALYTICAL RESULTS
DONA ANA DAIRIES, DONA ANA COUNTY, NEW MEXICO**

Monitoring Well	Date Sampled	Nitrate as N (mg/l)	TKN (mg/l)	Chloride (mg/l)	TDS (mg/l)
70-04	8-May-23	22	<5.0	700	3,020
	9-Feb-23	33	<5.0	730	3,090
	8-Nov-22	35	<5.0	660	3,000
	9-Aug-22	25	<5.0	540	3,020
	9-May-22	24	<5.0	550	3,220
	15-Feb-22	17	<2.0	600	3,000
	5-Nov-21	19	<2.0	600	3,030
	10-Aug-21	14	<2.0	610	2,990
	10-May-21	12	<2.0	560	3,010
	16-Feb-21	22	<5.0	600	2,940
	12-Nov-20	35	<5.0	630	2,940
	14-Aug-20	21	<5.0	600	2,900
	13-May-20	20	<2.0	610	2,750
	10-Feb-20	37	<5.0	670	3,190
	12-Nov-19	42	<5.0	640	3,020
	6-Aug-19	38	<2.0	640	2,940
	16-May-19	27	<5.0	680	3,020
	26-Feb-19	25	<5.0	720	3,020
	14-Nov-18	29	<5.0	780	2,980
	15-Aug-18	27	<5.0	680	3,070
	21-May-18	27	<5.0	720	3,150
	13-Feb-18	27	<5.0	710	2,860
	9-Nov-17	26.5	<0.0500	651	2,740
	14-Aug-17	24.6	0.380	655	2,820
	19-May-17	23.9	<0.0501	618	2,680
	20-Feb-17	26.1	<0.0501	644	2,970
	22-Nov-16	26.5	<0.300	625	2,900
	18-Aug-16	27.8	<0.937	739	2,920
	23-May-16	27.3	<2.24	423	2,780
	16-Feb-16	31.4	<1.18	626	2,670
	12-Nov-15	28.9	5.60	604	2,700
	19-Aug-15	29.4	<1.18	561	2,820
	12-May-15	27.5	1.40	579	2,860
10-Feb-15	27.0	<1.80	561	2,580	
17-Nov-14	20.2	<1.80	375	2,720	
20-Aug-14	24.4	<1.80	577	2,950	
15-May-14	24.6	<1.80	610	2,630	
19-Feb-14	22.3	<1.66	607	2,580	
14-Nov-13	21.0	2.80	649	2,630	
9-Aug-13	21.7	4.20	636	2,780	
9-May-13	23.0	<1.66	630	3,510	
11-Jan-13	19.5	<1.72	613	6,200	
Buena Vista Dairy I					
86-01	26-Jan-11	95.4	16.0	2,300	6,240
	20-Sep-10	86.9	<10.0	2,330	6,500
	29-Jun-10	67	<1.0	1,800	5,010
	25-Mar-10	27.0	0.28	1,770	4,814
	15-Dec-09	29.8	ND	1,750	4,670
	1-Sep-09	26.1	ND	1,510	4,474
	2-Jun-09	46.5	4.76	1,590	4,464
	4-Mar-09	42	ND	1,659	4,850
86-02	26-Jan-11	23.4	2.24	641	3,110
	20-Sep-10	24.1	<10.0	613	2,980
	29-Jun-10	21	1.1	660	3,020
	25-Mar-10	16.2	0.7	740	2,740
	15-Dec-09	10.7	0.28	730	2,818
	1-Sep-09	7.2	ND	710	2,824
	2-Jun-09	2.95	ND	700	2,802
	4-Mar-09	16.4	ND	625	2,666

**TABLE 5. DISCHARGE PLAN MONITORING WELL GROUNDWATER ANALYTICAL RESULTS
DONA ANA DAIRIES, DONA ANA COUNTY, NEW MEXICO**

Monitoring Well	Date Sampled	Nitrate as N (mg/l)	TKN (mg/l)	Chloride (mg/l)	TDS (mg/l)
Bright Star Dairy					
340-01	5-May-23	62	<1.0	610	2,870
	8-Feb-23	61	<5.0	600	2,840
	8-Nov-22	60	<5.0	680	2,940
	27-Oct-22	58	<5.0	560	2,970
	5-May-22	47	<5.0	610	2,990
	14-Feb-22	48	<5.0	630	2,950
	4-Nov-21	46	<5.0	610	2,980
	9-Aug-21	46	<5.0	580	2,940
	6-May-21	41	<5.0	580	2,900
	15-Feb-21	42	<5.0	570	2,930
	11-Nov-20	41	<5.0	560	2,940
	13-Aug-20	42	<2.0	550	2,950
	14-May-20	42	<5.0	590	2,950
	7-Feb-20	46	<5.0	560	2,850
	12-Nov-19	46	<5.0	560	2,920
	6-Aug-19	48	<2.0	590	2,830
	14-May-19	49	<5.0	610	2,990
	25-Feb-19	50	<5.0	630	3,020
	15-Nov-18	49	<5.0	540	2,880
	14-Aug-18	45	<5.0	560	2,830
	21-May-18	44	<5.0	560	2,700
	12-Feb-18	44	<5.0	640	2,870
	8-Nov-17	46.5	<0.300	576	2,920
	11-Aug-17	46.5	<0.0500	417	2,830
	18-May-17	40.7	<0.0501	579	2,890
	16-Feb-17	40.3	6.48	591	2,820
	10-Nov-16	38.2	1.14	584	2,820
	23-Aug-16	35.3	<0.937	618	3,050
	18-May-16	32.6	<2.24	594	2,980
	11-Feb-16	34.0	<1.18	621	3,080
	9-Nov-15	29.8	<1.18	578	2,820
	20-Aug-15	34.9	<1.18	486	3,080
	11-May-15	41.8	<1.18	437	3,680
	19-Feb-15	50.0	<1.80	339	2,780
	12-Nov-14	49.9	<1.80	337	2,630
	15-Aug-14	37.9	<1.80	383	2,800
	14-May-14	27.4	<1.80	608	2,770
	20-Feb-14	29.1	2.80	564	2,800
	11-Nov-13	29.2	3.50	600	2,800
	8-Aug-13	28.6	4.90	694	2,000
	9-May-13	31.1	<1.66	577	3,700
13-Feb-13	27.0	<1.72	711	3,340	
5-Nov-12	23.8	<1.72	855	3,180	
6-Aug-12	22.7	<1.72	694	3,380	
25-Apr-12	26.3	61.0	681	2,540	
2-Feb-12	27.4	<2.17	661	2,780	
4-Nov-11	26.6	4.34	691	2,910	
25-Jul-11	28.3	4.20	747	2,830	
27-Jan-11	31.1	3.50	578	2,840	
21-Sep-10	24.8	<10.0	513	3,070	
29-Jun-10	29	<0.10	610	2,810	
24-Mar-10	18.8	ND	580	2,508	
15-Dec-09	13.1	ND	650	2,608	
1-Sep-09	12.20	ND	530	2,522	
2-Jun-09	8.67	ND	590	2,434	
4-Mar-09	28.3	ND	530	2,516	

**TABLE 5. DISCHARGE PLAN MONITORING WELL GROUNDWATER ANALYTICAL RESULTS
DONA ANA DAIRIES, DONA ANA COUNTY, NEW MEXICO**

Monitoring Well	Date Sampled	Nitrate as N (mg/l)	TKN (mg/l)	Chloride (mg/l)	TDS (mg/l)	
340-02	5-May-23	Dry				
	8-Feb-23					
	8-Nov-22					
	9-Aug-22	58	<5.0	670	3,090	
	5-May-22	48	<5.0	630	3,040	
	14-Feb-22	55	<5.0	850	3,200	
	4-Nov-21	63	<5.0	810	3,170	
	9-Aug-21	66	<5.0	760	3,240	
	6-May-21	65	<5.0	760	3,440	
	15-Feb-21	75	<5.0	820	3,290	
	11-Nov-20	70	<5.0	810	3,190	
	14-Aug-20	72	<5.0	790	3,240	
	14-May-20	66	<5.0	780	3,170	
	7-Feb-20	75	<5.0	760	3,280	
	12-Nov-19	68	<5.0	750	3,230	
	6-Aug-19	68	<1.0	720	2,990	
	14-May-19	66	<5.0	770	3,050	
	25-Feb-19	67	<5.0	770	3,080	
	15-Nov-18	69	<5.0	750	3,060	
	14-Sep-18	78	<5.0	730	3,200	
	21-May-18	74	<5.0	710	3,220	
	12-Feb-18	84	<5.0	770	3,220	
	8-Nov-17	89.7	<0.300	820	3,010	
	11-Aug-17	92.4	<0.0500	858	3,260	
	18-May-17	101	<0.0501	896	3,260	
	16-Feb-17	101	<0.0501	875	3,350	
	10-Nov-16	93.8	<0.937	878	3,280	
	23-Aug-16	114	<0.937	1,140	3,270	
	18-May-16	Insufficient Water to Sample				
	11-Feb-16	99.1	<1.18	899	3,240	
	9-Nov-15	89.2	<1.18	870	3,200	
	20-Aug-15	83.0	<1.18	782	3,210	
	11-May-15	83.6	<1.18	802	3,100	
	9-Feb-15	91.2	<1.80	809	3,340	
	12-Nov-14	90.1	<1.80	807	3,320	
	15-Aug-14	84.4	<1.80	772	3,420	
	14-May-14	84.6	<1.80	793	3,130	
	20-Feb-14	86.8	<1.66	806	3,080	
	11-Nov-13	87.0	3.50	807	3,160	
	8-Aug-13	80.2	4.90	794	3,180	
9-May-13	74.6	<1.66	744	3,180		
13-Feb-13	81.6	<1.72	805	3,550		
5-Nov-12	73.8	4.90	923	3,220		
6-Aug-12	74.0	<1.72	749	3,380		
25-Apr-12	69.8	6.16	727	2,890		
4-Nov-11	75.0	5.74	755	3,620		
22-Jul-11	84.8	7.98	777	2,970		
27-Jan-11	94.1	2.24	760	3,500		
21-Sep-10	92.2	<10.0	778	3,260		
29-Jun-10	87	<0.10	850	3,180		
24-Mar-10	95	ND	930	3,070		
15-Dec-09	82	ND	910	3,072		
1-Sep-09	94	ND	890	3,072		
2-Jun-09	43.2	ND	880	2,954		
4-Mar-09	41.5	ND	885	3,098		

**TABLE 5. DISCHARGE PLAN MONITORING WELL GROUNDWATER ANALYTICAL RESULTS
DONA ANA DAIRIES, DONA ANA COUNTY, NEW MEXICO**

Monitoring Well	Date Sampled	Nitrate as N (mg/l)	TKN (mg/l)	Chloride (mg/l)	TDS (mg/l)
Former D&J Dairy (Dominguez 2)					
42-02	10-May-23	8.8	<1.0	610	2,710
	13-Feb-23	9.2	<1.0	550	2,830
	10-Nov-22	9.1	1.3	490	2,660
	11-Aug-22	9.4	<1.0	470	2,620
	11-May-22	10	<2.0	530	2,740
	16-Feb-22	7.3	<1.0	520	2,850
	9-Nov-21	6.6	<1.0	560	2,710
	11-Aug-21	11	<2.0	520	2,660
	11-May-21	7.3	<1.0	490	2,720
	18-Feb-21	7.1	<1.0	540	2,860
	16-Nov-20	7.5	1.1	550	2,800
	18-Aug-20	8.5	<1.0	410	2,400
	22-May-20	10	<2.0	460	2,570
	11-Feb-20	10	<2.0	490	2,680
	22-Nov-19	9.1	<1.0	430	2,620
	16-Aug-19	9.3	<1.0	420	2,440
	29-May-19	7.4	<1.0	470	2,750
	6-Mar-19	7.0	<1.0	460	2,750
	4-Dec-18	7.8	<1.0	580	3,090
	22-Aug-18	7.3	1.1	450	2,600
	29-May-18	7.6	<1.0	610	3,050
	21-Feb-18	8.1	1.1	610	2,960
	1-Dec-17	10.2	0.332	590	2,510
	22-Aug-17	14.8	<0.300	514	2,630
	2-Jun-17	11.0	0.939	542	2,730
	6-Mar-17	12.3	<0.300	501	2,650
	28-Nov-16	11.1	<0.300	506	2,760
	31-Aug-16	12.8	<0.937	539	2,700
	1-Jun-16	8.79	<2.24	469	2,580
	23-Feb-16	9.10	4.48	535	2,560
	1-Dec-15	7.55	<1.18	510	2,420
	26-Aug-15	6.38	5.60	492	2,540
	18-May-15	6.92	5.60	482	2,360
	26-Feb-15	7.61	6.30	483	2,580
	18-Nov-14	8.21	<1.80	461	2,400
	26-Aug-14	7.62	<1.80	477	2,350
	21-May-14	10.2	2.10	498	2,460
	26-Feb-14	9.28	<1.66	469	2,180
	26-Nov-13	9.62	2.10	490	2,260
	20-Aug-13	14.5	4.90	459	2,360
14-May-13	12.0	<1.66	432	2,220	
15-Feb-13	17.6	<1.72	457	2,360	
9-Nov-12	8.99	<1.72	412	2,180	
8-Aug-12	7.73	<1.72	400	1,830	
1-May-12	22.5	<1.72	431	2,210	
16-Feb-12	24.5	<2.17	465	2,770	
9-Nov-11	21.2	3.08	449	2,170	
2-Aug-11	20.5	2.38	424	2,360	
25-Apr-11	29.1	<2.17	365	2,140	
28-Jan-11	22.7	6.72	408	2,150	
1-Oct-10	21.0	<10.0	355	2,010	
27-Jun-10	27	<5.0	360	2,220	
6-Mar-10	31.3	<0.3	380	2,145	
16-Jan-10	25.7	0.3	350	2,090	
15-Sep-09	24.6	0.9	350	2,075	
3-Jun-09	30.6	0.6	320	2,045	
14-Mar-09	29.6	0.7	370	2,115	

**TABLE 5. DISCHARGE PLAN MONITORING WELL GROUNDWATER ANALYTICAL RESULTS
DONA ANA DAIRIES, DONA ANA COUNTY, NEW MEXICO**

Monitoring Well	Date Sampled	Nitrate as N (mg/l)	TKN (mg/l)	Chloride (mg/l)	TDS (mg/l)
42-03	9-May-23	34	<5.0	1,200	3,160
	10-Feb-23	31	<5.0	1,000	3,230
	9-Nov-22	33	<5.0	980	3,230
	10-Aug-22	34	<5.0	1,000	3,290
	10-May-22	33	<5.0	970	3,280
	16-Feb-22	31	<5.0	1,000	3,240
	8-Nov-21	31	<5.0	1,100	3,240
	10-Aug-21	28	<5.0	1,100	3,220
	11-May-21	28	<5.0	1,000	3,230
	17-Feb-21	29	<5.0	1,100	3,210
	16-Nov-20	30	<5.0	1,100	3,340
	18-Aug-20	30	<1.0	1,100	3,340
	20-May-20	28	<5.0	1,100	3,300
	11-Feb-20	26	<5.0	1,200	3,370
	22-Nov-19	29	<1.0	1,000	3,380
	16-Aug-19	34	<1.0	1,200	3,420
	30-May-19	30	<5.0	1,200	3,380
	6-Mar-19	32	<5.0	1,100	3,390
	4-Dec-18	41	<5.0	1,200	3,550
	22-Aug-18	40	<5.0	1,100	3,530
	29-May-18	43	<5.0	1,200	3,590
	21-Feb-18	36	<5.0	1,200	3,570
	1-Dec-17	43.6	<0.300	1,350	3,350
	23-Aug-17	54.5	<0.300	1,010	3,540
	2-Jun-17	57.1	<0.100	1,120	3,630
	6-Mar-17	49.2	<0.300	1,170	3,690
	28-Nov-16	50.2	<0.300	1,180	3,730
	31-Aug-16	93.5	<0.937	983	3,400
	1-Jun-16	90.0	<2.24	956	3,680
	23-Feb-16	68.0	<1.18	1,190	3,740
	1-Dec-15	97.9	<1.18	933	3,380
	26-Aug-15	74.7	<1.18	1,040	3,820
	18-May-15	86.9	2.1	1,010	3,470
	27-Feb-15	68.6	<1.80	1,020	3,630
	18-Nov-14	73.2	16.1	1,040	3,560
	26-Aug-14	78.0	<1.80	891	3,360
	21-May-14	62.6	<1.80	1,100	3,720
	26-Feb-14	62.8	<1.66	1,070	3,160
	26-Nov-13	62.9	2.80	1,090	3,660
	15-Aug-13	67.5	17.5	1,090	3,560
14-May-13	59.6	<1.66	1,150	3,800	
15-Feb-13	60.3	<1.72	1,140	3,800	
9-Nov-12	56.2	<1.72	1,120	3,800	
8-Aug-12	71.1	<1.72	1,370	3,520	
1-May-12	51.5	<1.72	1,030	3,620	
16-Feb-12	51.3	<2.17	1,130	3,760	
9-Nov-11	58.9	2.80	1,000	3,660	
1-Aug-11	59.2	<2.17	1,030	3,720	
25-Apr-11	58.8	<2.17	1,080	3,620	
28-Jan-11	69.5	3.78	1,160	3,690	
1-Oct-10	63.0	<10.0	1,090	3,640	
27-Jun-10	49	<5.0	1,100	3,780	
6-Mar-10	39.6	<0.3	1,180	3,935	
16-Jan-10	43.3	<0.3	1,200	3,800	
15-Sep-09	52.3	0.3	1,130	3,765	
3-Jun-09	48.2	0.3	1,240	3,860	
14-Mar-09	32.2	<0.2	1,240	3,800	

**TABLE 5. DISCHARGE PLAN MONITORING WELL GROUNDWATER ANALYTICAL RESULTS
DONA ANA DAIRIES, DONA ANA COUNTY, NEW MEXICO**

Monitoring Well	Date Sampled	Nitrate as N (mg/l)	TKN (mg/l)	Chloride (mg/l)	TDS (mg/l)
42-06	9-May-23	91	<5.0	370	2,530
	10-Feb-23	120	<5.0	390	2,530
	9-Nov-22	82	<5.0	360	2,400
	10-Aug-22	91	<5.0	360	2,520
	10-May-22	170	<1.0	520	3,420
	17-Feb-22	170	<5.0	570	3,510
	8-Nov-21	200	<5.0	650	3,620
	11-Aug-21	200	<5.0	590	3,500
	11-May-21	210	<5.0	630	3,710
	18-Feb-21	230	<5.0	720	3,800
	16-Nov-20	190	<5.0	560	3,260
	18-Aug-20	150	<1.0	480	3,030
	22-May-20	200	<5.0	620	3,480
	12-Feb-20	150	<5.0	470	2,850
	22-Nov-19	180	<1.0	360	2,760
	16-Aug-19	150	<1.0	440	2,740
	30-May-19	140	<5.0	350	2,540
	6-Mar-19	130	<5.0	470	2,810
	4-Dec-18	97	<5.0	560	2,690
	22-Aug-18	140	<5.0	420	2,850
	29-May-18	160	<5.0	610	3,060
	21-Feb-18	140	<5.0	590	2,920
	1-Dec-17	129	<0.300	522	2,350
	22-Aug-17	123	<0.300	295	2,250
	2-Jun-17	98.1	0.615	424	2,340
	6-Mar-17	102	<0.300	280	2,180
	28-Nov-16	66.9	<0.300	291	2,100
	31-Aug-16	67.9	<0.937	275	1,970
	1-Jun-16	87.7	<2.24	300	2,250
	23-Feb-16	60.0	<1.18	308	2,050
	1-Dec-15	84.5	<1.18	358	2,220
	26-Aug-15	80.7	<1.18	391	2,680
	18-May-15	90.6	2.80	373	2,160
	26-Feb-15	78.0	2.80	323	2,100
	18-Nov-14	94.6	<1.80	302	2,160
	13-Aug-14	83.6	<1.80	302	2,220
	21-May-14	87.9	2.80	395	2,440
	26-Feb-14	59.3	<1.66	417	2,380
	26-Nov-13	76.3	2.10	397	2,270
	20-Aug-13	95.1	4.90	432	2,580
	14-May-13	86.5	<1.66	413	2,390
	15-Feb-13	82.9	<1.72	457	2,430
9-Nov-12	75.9	<1.72	478	2,570	
8-Aug-12	81.5	1.82	484	2,475	
1-May-12	87.0	1.96	720	2,920	
16-Feb-12	92.4	<2.17	630	3,100	
9-Nov-11	101	<2.17	617	3,000	
2-Aug-11	88.6	3.22	525	2,980	
25-Apr-11	72.2	<2.17	454	2,500	
28-Jan-11	69.8	4.20	421	2,780	
1-Oct-10	113	<10.0	497	2,660	
27-Jun-10	46	<5.0	400	2,550	
6-Mar-10	43.1	<0.3	480	2,510	
16-Jan-10	44.2	0.3	1,150	2,600	
14-Sep-09	54.8	0.4	450	2,600	
3-Jun-09	0.02	<0.2	1,240	3,780	
14-Mar-09	49.7	0.2	480	2,540	

**TABLE 5. DISCHARGE PLAN MONITORING WELL GROUNDWATER ANALYTICAL RESULTS
DONA ANA DAIRIES, DONA ANA COUNTY, NEW MEXICO**

Monitoring Well	Date Sampled	Nitrate as N (mg/l)	TKN (mg/l)	Chloride (mg/l)	TDS (mg/l)
42-07	10-Nov-20	Plugged and Abandoned			
	18-Aug-20	Dry			
	11-Feb-20	Dry			
	22-Nov-19	Dry			
	16-Aug-19	Dry			
	29-May-19	Dry			
	6-Mar-19	Dry			
	4-Dec-18	Dry			
	23-Aug-18	Dry			
	29-May-18	Dry			
	21-Feb-18	Dry			
	22-Aug-17	Dry			
	2-Jun-17	Dry			
	6-Mar-17	Dry			
	28-Nov-16	Dry			
	31-Aug-16	Dry			
	1-Jun-16	Dry			
	23-Feb-16	Dry			
	1-Dec-15	Dry			
	26-Aug-15	Dry			
	18-May-15	Dry			
	26-Feb-15	Dry			
	18-Nov-14	Dry			
	26-Aug-14	Dry			
	22-May-14	Dry			
	26-Feb-14	Dry			
	26-Nov-13	Dry			
	15-Aug-13	Dry			
	14-May-13	Dry			
	15-Feb-13	Dry			
	9-Nov-12	Dry			
	8-Aug-12	Dry			
1-May-12	Dry				
16-Feb-12	Dry				
9-Nov-11	57.9	<2.17	1,090	3,450	
2-Aug-11	Dry				
25-Apr-11	68.5	<2.17	1,230	4,080	
28-Jan-11	88.3	4.48	1,130	4,180	
1-Oct-10	92.0	<40.0	1,390	4,260	
27-Jun-10	63	<5.0	1,400	4,330	
6-Mar-10	63.1	<0.3	1,490	4,345	
16-Jan-10	59.6	<0.3	1,480	4,275	
15-Sep-09	66.6	<0.3	1,290	4,195	
3-Jun-09	57.4	<0.2	1,550	4,225	
14-Mar-09	43.7	<0.2	1,500	4,110	

**TABLE 5. DISCHARGE PLAN MONITORING WELL GROUNDWATER ANALYTICAL RESULTS
DONA ANA DAIRIES, DONA ANA COUNTY, NEW MEXICO**

Monitoring Well	Date Sampled	Nitrate as N (mg/l)	TKN (mg/l)	Chloride (mg/l)	TDS (mg/l)	
42-08	10-May-23	11	<2.0	530	2,600	
	13-Feb-23	22	<5.0	280	1,860	
	9-Nov-22	16	<2.0	370	2,160	
	10-Aug-22	19	<2.0	310	2,090	
	11-May-22	24	<5.0	260	1,800	
	17-Feb-22	25	<5.0	270	1,830	
	9-Nov-21	32	<5.0	230	1,640	
	11-Aug-21	36	<5.0	220	1,700	
	11-May-21	40	<5.0	180	1,460	
	18-Feb-21	35	<5.0	250	1,730	
	16-Nov-20	42	<5.0	170	1,680	
	18-Aug-20	17	<1.0	370	2,290	
	22-May-20	42	<5.0	240	1,780	
	12-Feb-20	40	<5.0	240	1,830	
	22-Nov-19	35	<1.0	290	2,000	
	16-Aug-19	42	<1.0	290	1,920	
	29-May-19	60	<5.0	130	1,410	
	6-Mar-19	49	<5.0	96	1,310	
	4-Dec-18	36	<5.0	54	1,280	
	22-Aug-18	29	<5.0	200	1,700	
	29-May-18	27	<5.0	93	1,200	
	21-Feb-18	20	<5.0	130	1,290	
	2-Dec-17	24.0	<0.300	135	1,160	
	22-Aug-17	30.6	<0.300	203	1,580	
	2-Jun-17	32.3	1.03	43	1,030	
	6-Mar-17	36.8	<0.300	41	1,200	
	28-Nov-16	37.0	<0.300	43	1,160	
	31-Aug-16	40.6	<0.937	53	1,300	
	1-Jun-16	Dry				
	23-Feb-16	Dry				
	1-Dec-15	Dry				
	26-Aug-15	37.4	<1.18	89.6	1,640	
	18-May-15	Not Sampled - insufficient water to sample				
	26-Feb-15	44.9	<1.80	85.7	1,400	
	18-Nov-14	47.3	<1.80	117	1,440	
	26-Aug-14	36.1	<1.80	159	1,500	
	21-May-14	33.1	<1.80	149	1,470	
	26-Feb-14	32.6	<1.66	251	1,790	
	26-Nov-13	30.8	2.10	275	1,780	
	20-Aug-13	30.3	6.30	292	2,000	
	14-May-13	29.9	<1.66	259	1,880	
	15-Feb-13	31.8	<1.72	284	1,860	
9-Nov-12	30.4	<1.72	283	1,930		
8-Aug-12	36.4	<1.72	307	1,938		
1-May-12	36.0	<1.72	246	1,700		
16-Feb-12	37.0	<2.17	254	1,850		
9-Nov-11	40.0	<2.17	269	1,770		
2-Aug-11	41.3	2.38	253	2,030		
25-Apr-11	51.4	2.66	201	1,970		
28-Jan-11	46.2	5.46	219	2,020		
1-Oct-10	49.0	<10.0	288	2,160		
27-Jun-10	75	<5.0	300	2,220		
6-Mar-10	76.8	<0.3	365	2,290		
16-Jan-10	82.8	<0.3	350	2,315		
15-Sep-09	87.1	0.7	410	2,340		
3-Jun-09	65.8	0.8	380	2,175		
14-Mar-09	43.2	0.4	400	2,220		

**TABLE 5. DISCHARGE PLAN MONITORING WELL GROUNDWATER ANALYTICAL RESULTS
DONA ANA DAIRIES, DONA ANA COUNTY, NEW MEXICO**

Monitoring Well	Date Sampled	Nitrate as N (mg/l)	TKN (mg/l)	Chloride (mg/l)	TDS (mg/l)
42-09	10-Nov-20	Plugged and Abandoned			
	1-Dec-15	Not Sampled - Destroyed			
	26-Aug-15	57.1	<1.18	712	3,020
	18-May-15	58.0	<1.18	733	3,050
	26-Feb-15	69.8	<1.80	673	2,960
	18-Nov-14	46.4	<1.80	722	3,000
	26-Aug-14	46.5	<1.80	674	3,000
	22-May-14	59.3	<1.80	699	3,060
	26-Feb-14	53.5	<1.66	715	3,030
	26-Nov-13	51.2	2.80	731	3,030
	15-Aug-13	56.1	37.8	725	3,010
	14-May-13	51.6	<1.66	717	3,200
	15-Feb-13	47.0	<1.72	653	2,870
	9-Nov-12	48.4	<1.72	641	3,030
	8-Aug-12	49.5	<1.72	597	2,475
	1-May-12	50.3	<1.72	542	2,820
	16-Feb-12	50.7	<2.17	627	2,920
	9-Nov-11	47.8	<2.17	591	1,810
	1-Aug-11	55.0	<2.17	579	2,750
	25-Apr-11	65.8	<2.17	664	2,820
	28-Jan-11	44.9	<2.17	537	2,940
	28-Sep-10	38.0	<10.0	591	2,760
	27-Jun-10	68	<5.0	610	3,010
	6-Mar-10	Not Sampled			
	16-Jan-10	52.8	<0.3	690	2,970
	15-Sep-09	68.8	0.7	650	3,000
3-Jun-09	66.5	0.7	690	3,000	
14-Mar-09	59.5	0.4	700	3,050	

**TABLE 5. DISCHARGE PLAN MONITORING WELL GROUNDWATER ANALYTICAL RESULTS
DONA ANA DAIRIES, DONA ANA COUNTY, NEW MEXICO**

Monitoring Well	Date Sampled	Nitrate as N (mg/l)	TKN (mg/l)	Chloride (mg/l)	TDS (mg/l)
42-10	11-May-23	7.9	<1.0	410	1,610
	14-Feb-23	6.3	<1.0	420	1,610
	10-Nov-22	7.4	<1.0	410	1,630
	11-Aug-22	6.7	<1.0	400	1,470
	11-May-22	6.4	<1.0	420	1,610
	15-Feb-22	6.1	<1.0	410	1,590
	9-Nov-21	4.5	<1.0	410	1,540
	12-Aug-21	3.8	<1.0	400	1,520
	12-May-21	3.0	<1.0	370	1,490
	17-Feb-21	2.1	<1.0	400	1,470
	13-Nov-20	1.4	<1.0	380	1,460
	19-Aug-20	<1.0	<1.0	380	1,440
	22-May-20	1.3	3.8	390	1,540
	12-Feb-20	1.2	<1.0	370	1,490
	25-Nov-19	0.84	<1.0	370	1,550
	19-Aug-19	<1.0	<1.0	400	1,540
	30-May-19	<1.0	<1.0	390	1,470
	6-Mar-19	<1.0	<1.0	370	1,410
	4-Dec-18	<1.0	<1.0	410	1,410
	22-Aug-18	<1.0	<1.0	370	1,390
	30-May-18	0.21	<1.0	380	1,360
	19-Feb-18	<1.0	<1.0	400	1,390
	4-Dec-17	0.592	<0.300	380	1,300
	23-Aug-17	0.469	<0.300	396	1,350
	2-Jun-17	0.429	1.23	405	1,300
	6-Mar-17	0.542	<0.300	403	1,270
	29-Nov-16	1.45	<0.300	425	1,380
	1-Sep-16	<0.305	<0.937	414	1,370
	1-Jun-16	0.354	<2.24	425	1,520
	23-Feb-16	<0.0610	<1.18	459	1,460
	1-Dec-15	0.165	<1.18	439	1,300
	25-Aug-15	<0.194	<1.18	436	1,440
	18-May-15	1.07	<1.18	471	1,360
	27-Feb-15	0.947	<1.80	439	1,520
	19-Nov-14	1.08	11.9	441	1,340
	26-Aug-14	1.08	<1.80	410	1,340
	22-May-14	1.25	<1.80	457	1,420
	26-Feb-14	0.982	<1.66	416	1,400
	26-Nov-13	1.10	2.10	435	1,420
	20-Aug-13	0.991	9.10	423	1,540
	14-May-13	0.976	<1.66	395	1,400
	15-Feb-13	<0.246	<1.72	415	1,380
9-Nov-12	<0.0290	<1.72	397	1,350	
8-Aug-12	0.186	<1.72	403	1,328	
1-May-12	0.236	<1.72	363	1,260	
16-Feb-12	<0.500	<2.17	419	1,440	
8-Nov-11	<0.500	<2.17	425	1,510	
2-Aug-11	<0.500	<2.17	469	1,540	
25-Apr-11	<0.500	<2.17	453	1,500	
28-Jan-11	2.15	<2.17	345	1,280	
1-Oct-10	0.220	<10.0	360	1,450	
27-Jun-10	<0.50	<1.0	420	1,490	
6-Mar-10	0.23	<0.3	440	1,500	
16-Jan-10	<0.03	<0.3	430	1,435	
15-Sep-09	0.16	<0.3	400	1,425	
3-Jun-09	0.21	<0.2	450	1,535	
14-Mar-09	0.02	<0.2	480	1,480	

**TABLE 5. DISCHARGE PLAN MONITORING WELL GROUNDWATER ANALYTICAL RESULTS
DONA ANA DAIRIES, DONA ANA COUNTY, NEW MEXICO**

Monitoring Well	Date Sampled	Nitrate as N (mg/l)	TKN (mg/l)	Chloride (mg/l)	TDS (mg/l)
42-11	10-May-23	<1.0	<1.0	440	1,420
	14-Feb-23	<1.0	<1.0	350	1,370
	10-Nov-22	<1.0	<1.0	360	1,380
	11-Aug-22	<1.0	<1.0	340	1,390
	11-May-22	<1.0	<1.0	350	1,390
	17-Feb-22	<1.0	<1.0	380	1,410
	9-Nov-21	<1.0	<1.0	390	1,400
	12-Aug-21	<1.0	<1.0	360	1,350
	12-May-21	<1.0	<1.0	350	1,390
	17-Feb-21	<1.0	<1.0	360	1,350
	13-Nov-20	<1.0	<1.0	330	1,310
	19-Aug-20	<1.0	<1.0	300	1,250
	22-May-20	1.1	<1.0	310	1,200
	12-Feb-20	1.3	<1.0	290	1,220
	25-Nov-19	1.4	<1.0	310	1,200
	19-Aug-19	1.2	<1.0	280	1,200
	30-May-19	1.3	<1.0	280	1,180
	6-Mar-19	1.3	<1.0	260	1,160
	4-Dec-18	1.3	<1.0	290	1,160
	22-Aug-18	1.4	<1.0	270	1,190
	30-May-18	1.4	<1.0	330	1,160
	19-Feb-18	1.4	<1.0	310	1,200
	4-Dec-17	1.66	<0.300	268	1,040
	23-Aug-17	1.72	<0.300	291	1,100
	2-Jun-17	1.38	0.591	293	1,090
	3-Mar-17	1.66	<0.300	298	1,140
	29-Nov-16	2.39	<0.300	301	1,120
	1-Sep-16	1.23	<0.937	305	1,180
	1-Jun-16	1.34	<2.24	302	1,190
	23-Feb-16	1.23	<1.18	319	1,190
	1-Dec-15	1.16	<1.18	303	1,160
	25-Aug-15	1.00	<1.18	302	1,160
	18-May-15	1.79	<1.18	308	1,100
	27-Feb-15	1.66	<1.80	300	1,160
	19-Nov-14	1.83	2.10	316	1,170
	27-Aug-14	1.78	6.30	295	1,200
	22-May-14	1.87	<1.80	312	1,120
	26-Feb-14	1.44	<1.66	339	1,280
	26-Nov-13	1.43	2.80	344	1,260
	20-Aug-13	1.50	2.80	334	1,280
	14-May-13	1.78	<1.66	303	1,220
	15-Feb-13	1.64	<1.72	327	1,210
9-Nov-12	<0.0290	<1.72	315	1,230	
8-Aug-12	1.21	<1.72	308	1,182	
1-May-12	1.24	<1.72	274	1,160	
16-Feb-12	<0.500	<2.17	337	1,240	
8-Nov-11	1.97	<2.17	334	1,480	
2-Aug-11	3.07	<2.17	308	1,160	
25-Apr-11	3.45	<2.17	304	795	
28-Jan-11	0.47	2.38	285	1,300	
1-Oct-10	0.62	<10.0	300	1,250	
27-Jun-10	3.90	<1.0	290	1,080	
6-Mar-10	0.51	<0.3	370	1,300	
16-Jan-10	0.03	<0.3	370	1,325	
15-Sep-09	0.41	<0.3	320	1,245	
3-Jun-09	3.00	0.70	300	1,080	
14-Mar-09	0.90	<0.2	310	1,225	

**TABLE 5. DISCHARGE PLAN MONITORING WELL GROUNDWATER ANALYTICAL RESULTS
DONA ANA DAIRIES, DONA ANA COUNTY, NEW MEXICO**

Monitoring Well	Date Sampled	Nitrate as N (mg/l)	TKN (mg/l)	Chloride (mg/l)	TDS (mg/l)
42-12	11-May-23	<1.0	<1.0	250	1,010
	14-Feb-23	1.8	<1.0	260	1,080
	10-Nov-22	<1.0	<1.0	270	1,090
	11-Aug-22	1.0	<1.0	260	1,070
	11-May-22	1.6	<1.0	250	1,080
	17-Feb-22	1.9	<1.0	270	1,090
	9-Nov-21	1.8	<1.0	270	1,080
	12-Aug-21	1.6	<1.0	290	1,110
	12-May-21	1.7	<1.0	270	1,120
	17-Feb-21	1.7	<1.0	290	1,090
	13-Nov-20	1.3	<1.0	310	1,100
	19-Aug-20	<1.0	<1.0	310	1,130
	22-May-20	1.1	<1.0	310	1,130
	12-Feb-20	1.3	<1.0	330	1,160
	25-Nov-19	1.1	<1.0	350	1,170
	19-Aug-19	<1.0	<1.0	330	1,170
	30-May-19	1.0	<1.0	320	1,180
	6-Mar-19	<1.0	<1.0	300	1,190
	4-Dec-18	<1.0	<1.0	330	1,190
	22-Aug-18	1.0	<1.0	330	1,190
	30-May-18	0.78	<1.0	370	1,200
	19-Feb-18	<1.0	<1.0	330	1,240
	4-Dec-17	0.825	0.460	321	1,030
	23-Aug-17	0.684	<0.300	325	1,170
	2-Jun-17	0.913	0.236	328	1,170
	6-Mar-17	1.07	<0.300	330	1,210
	29-Nov-16	1.84	<0.300	346	1,200
	1-Sep-16	0.731	<0.937	344	1,210
	1-Jun-16	0.949	<2.24	341	1,250
	23-Feb-16	0.789	<1.18	352	1,140
	1-Dec-15	0.917	<1.18	341	1,140
	25-Aug-15	0.774	<1.18	340	1,110
	18-May-15	1.78	<1.18	350	1,120
	27-Feb-15	1.87	<1.80	327	1,200
	19-Nov-14	2.10	<1.80	333	1,220
	26-Aug-14	1.96	48.3	319	1,290
	22-May-14	2.18	<1.80	337	1,160
	26-Feb-14	1.87	<1.66	336	1,180
	26-Nov-13	1.95	2.10	341	1,160
	20-Aug-13	1.77	3.50	337	1,200
	14-May-13	1.73	<1.66	319	1,170
	15-Feb-13	1.72	<1.72	332	1,170
9-Nov-12	<0.0290	<1.72	315	1,170	
8-Aug-12	1.15	2.66	333	1,134	
1-May-12	0.750	<1.72	282	1,180	
16-Feb-12	<0.500	<2.17	341	1,200	
8-Nov-11	<0.500	<2.17	331	730	
2-Aug-11	<0.100	<2.17	331	1,340	
25-Apr-11	<0.500	<2.17	339	1,280	
28-Jan-11	0.580	<2.17	276	970	
1-Oct-10	4.50	<10.0	312	1,280	
27-Jun-10	0.72	<1.0	320	1,270	
6-Mar-10	0.13	<0.3	350	1,230	
16-Jan-10	0.42	<0.3	340	1,250	
15-Sep-09	0.65	<0.3	310	1,215	
3-Jun-09	0.82	<0.2	330	1,280	
14-Mar-09	0.70	<0.2	340	1,240	

**TABLE 5. DISCHARGE PLAN MONITORING WELL GROUNDWATER ANALYTICAL RESULTS
DONA ANA DAIRIES, DONA ANA COUNTY, NEW MEXICO**

Monitoring Well	Date Sampled	Nitrate as N (mg/l)	TKN (mg/l)	Chloride (mg/l)	TDS (mg/l)	
42-13	9-May-23	11	<2.0	900	3,060	
	10-Feb-23	15	<2.0	1,000	3,250	
	9-Nov-22	16	<2.0	980	3,270	
	10-Aug-22	16	<2.0	950	3,290	
	10-May-22	21	<5.0	940	3,380	
	16-Feb-22	16	<2.0	1,000	3,330	
	8-Nov-21	16	<2.0	1,000	3,310	
	11-Aug-21	20	<5.0	1,000	3,330	
	11-May-21	20	<2.0	1,000	3,340	
	17-Feb-21	39	<5.0	1,100	3,510	
	16-Nov-20	48	<5.0	1,100	3,670	
	18-Aug-20	69	<1.0	1,000	3,710	
	22-May-20	42	<5.0	950	3,390	
	11-Feb-20	41	<5.0	990	3,520	
	22-Nov-19	33	<1.0	1,000	3,570	
	16-Aug-19	Not Sampled - Water level below pump				
	29-May-19	Not Sampled - Water level below pump				
	6-Mar-19	54	<5.0	910	3,510	
	4-Dec-18	Not Sampled - Water level below pump				
	22-Aug-18	43	<5.0	1,000	3,470	
	29-May-18	61	<5.0	970	3,590	
	21-Feb-18	57	<5.0	1,000	3,540	
	1-Dec-17	48.0	<0.300	1,090	3,240	
	23-Aug-17	Pump Not Operational				
	2-Jun-17	Pump Not Operational				
	6-Mar-17	43.6	0.374	838	3,410	
	28-Nov-16	43.5	<0.300	839	3,340	
	31-Aug-16	Not Sampled - Water level below pump				
	1-Jun-16	Not Sampled - Water level below pump				
	23-Feb-16	Not Sampled - Water level below pump				
	1-Dec-15	Not Sampled - Water level below pump				
	26-Aug-15	49.3	<1.18	756	3,480	
	18-May-15	50.6	<1.18	830	3,340	
	26-Feb-15	49.0	<1.80	781	3,420	
	18-Nov-14	54.6	<1.80	855	3,360	
	27-Aug-14	77.9	2.10	927	3,490	
	22-May-14	50.9	<1.80	873	3,560	
	26-Feb-14	50.0	<1.66	871	3,340	
	26-Nov-13	49.8	3.50	895	3,260	
	15-Aug-13	59.9	3.50	891	3,380	
	14-May-13	49.7	<1.66	809	3,320	
	15-Feb-13	54.3	<1.72	855	3,430	
	9-Nov-12	52.2	<1.72	835	3,250	
	8-Aug-12	62.3	<1.72	871	3,110	
	1-May-12	81.5	<1.72	902	3,550	
	16-Feb-12	99.1	<2.17	1,020	3,880	
	9-Nov-11	61.5	<2.17	901	3,160	
	2-Aug-11	106	<2.17	1,900	3,280	
	25-Apr-11	55.9	<2.17	1,000	3,600	
	28-Jan-11	52.6	<2.17	868	3,720	
29-Sep-10	44.5	<10.0	833	3,360		
27-Jun-10	48	<5.0	1,000	3,810		
6-Mar-10	Not Sampled					
16-Jan-10	46.3	<0.3	1,130	3,810		
15-Sep-09	54.8	0.5	1,100	3,940		
3-Jun-09	51.6	<0.2	1,110	3,775		
14-Mar-09	51.0	0.6	1,040	3,735		

**TABLE 5. DISCHARGE PLAN MONITORING WELL GROUNDWATER ANALYTICAL RESULTS
DONA ANA DAIRIES, DONA ANA COUNTY, NEW MEXICO**

Monitoring Well	Date Sampled	Nitrate as N (mg/l)	TKN (mg/l)	Chloride (mg/l)	TDS (mg/l)
Dominguez					
624-01	12-May-23	12	<2.0	850	2,680
	16-Feb-23	13	<2.0	860	2,770
	11-Nov-22	12	<2.0	840	2,880
	12-Aug-22	12	<2.0	920	2,820
	12-May-22	19	<2.0	750	2,550
	18-Feb-22	6.1	<1.0	670	2,340
	10-Nov-21	4.5	<1.0	650	2,220
	27-Aug-21	10	<2.0	700	2,400
	14-May-21	6.7	<1.0	560	1,960
	18-Feb-21	3.1	2.5	540	1,950
	13-Nov-20	4.3	<1.0	540	1,990
	17-Aug-20	3.7	<1.0	500	1,910
	15-May-20	6.6	<1.0	520	1,980
	12-Feb-20	8.7	<1.0	510	2,050
	15-Nov-19	13	<2.0	550	2,190
	13-Aug-19	9.2	<1.0	660	2,390
	20-May-19	12	<2.0	910	2,860
	28-Feb-19	11	<2.0	1,000	3,170
	20-Nov-18	16	<5.0	630	2,180
	29-Aug-18	9.9	<1.0	990	3,700
	22-May-18	13	<2.0	1,000	3,240
	14-Feb-18	13	<2.0	940	3,110
	14-Nov-17	12.7	<0.300	979	2,750
	15-Aug-17	14.8	<0.300	1,050	3,080
	23-May-17	14.6	<0.300	1,060	3,030
	22-Feb-17	15.3	<0.0501	997	3,210
	14-Nov-16	11.3	<0.937	1,040	3,260
	19-Aug-16	7.25	<0.937	926	2,970
	19-May-16	20.6	<2.24	808	2,710
	16-Feb-16	11.0	1.68	744	2,480
	10-Nov-15	7.06	3.36	703	2,440
	7-Aug-15	14.0	<1.18	1,010	3,110
	19-May-15	16.7	1.40	750	3,070
	12-Feb-15	9.54	2.10	798	2,880
	17-Nov-14	11.2	<1.80	790	2,620
	19-Aug-14	11.8	<1.80	794	2,590
	20-May-14	23.2	4.90	1,050	3,320
	25-Feb-14	18.6	<1.66	950	3,080
	19-Nov-13	23.6	2.10	1,080	3,250
	14-Aug-13	15.4	3.50	970	2,990
13-May-13	20.8	<1.66	894	2,720	
14-Feb-13	15.6	<1.72	827	2,980	
12-Nov-12	12.2	<1.72	652	2,590	
9-Aug-12	17.4	2.80	1,080	3,550	
30-Apr-12	8.69	36.4	1,400	4,180	
7-Feb-12	10.0	9.52	1,420	3,180	
4-Nov-11	10.8	5.60	1,430	3,460	
3-Aug-11	10.7	<2.17	1,580	3,970	
27-Apr-11	<0.500	30.8	1,330	4,040	
25-Jan-11	14.0	<2.17	1,280	3,760	
21-Sep-10	8.20	<10.0	1,260	3,780	
27-Jun-10	11	<2.0	1,600	4,520	
6-Mar-10	17.2	<0.3	910	2,610	
16-Jan-10	5.5	0.4	840	2,540	
15-Sep-09	6.5	0.6	760	2,455	
3-Jun-09	16.1	0.7	810	2,790	
14-Mar-09	21.9	0.3	1,190	3,305	

**TABLE 5. DISCHARGE PLAN MONITORING WELL GROUNDWATER ANALYTICAL RESULTS
DONA ANA DAIRIES, DONA ANA COUNTY, NEW MEXICO**

Monitoring Well	Date Sampled	Nitrate as N (mg/l)	TKN (mg/l)	Chloride (mg/l)	TDS (mg/l)
624-02	12-May-23	9.3	<1.0	690	2,680
	16-Feb-23	9.2	<1.0	640	2,720
	11-Nov-22	8.7	<1.0	600	2,740
	12-Aug-22	13	<2.0	850	3,240
	12-May-22	13	<2.0	800	3,430
	18-Feb-22	12	<2.0	830	3,240
	11-Nov-21	7.2	<1.0	680	2,840
	27-Aug-21	4.1	<1.0	480	2,160
	14-May-21	5.6	<1.0	740	2,710
	19-Feb-21	3.6	<1.0	650	2,320
	12-Nov-20	5.2	<1.0	480	2,300
	17-Aug-20	5.4	<1.0	610	2,350
	15-May-20	4.3	<1.0	550	2,300
	12-Feb-20	4.4	<1.0	480	2,210
	15-Nov-19	5.2	<1.0	530	2,470
	13-Aug-19	7.7	<1.0	790	2,860
	20-May-19	7.4	<1.0	770	2,860
	28-Feb-19	8.2	<1.0	950	3,130
	20-Nov-18	9.4	<2.0	850	3,010
	29-Aug-18	8.9	<1.0	710	2,160
	22-May-18	10	<2.0	860	3,290
	14-Feb-18	9.1	<1.0	720	2,920
	14-Nov-17	8.97	0.364	706	2,780
	15-Aug-17	10.9	2.00	796	3,020
	23-May-17	14.2	<0.300	827	3,590
	22-Feb-17	11.7	<0.0501	793	3,060
	14-Nov-16	8.58	<0.937	747	2,850
	19-Aug-16	6.46	<0.937	692	2,590
	19-May-16	18.5	<2.24	914	3,280
	16-Feb-16	10.2	<1.18	785	2,800
	10-Nov-15	17.2	<1.18	1,050	3,290
	7-Aug-15	15.6	<1.18	801	2,710
	19-May-15	17.3	<1.18	859	3,020
	12-Feb-15	17.0	<1.80	810	3,320
	18-Nov-14	15.6	<1.80	912	3,100
	19-Aug-14	13.9	<1.80	995	3,380
	20-May-14	12.7	2.10	1,010	3,350
	25-Feb-14	12.4	<1.66	965	3,320
	19-Nov-13	12.6	9.10	969	3,200
	14-Aug-13	11.4	4.20	1,030	3,350
13-May-13	9.98	<1.66	950	3,360	
14-Feb-13	9.30	2.10	1,110	3,580	
12-Nov-12	12.7	<1.72	1,170	3,830	
9-Aug-12	9.69	<1.72	1,300	4,010	
30-Apr-12	16.4	4.06	1,160	3,650	
7-Feb-12	14.8	<2.17	1,200	3,720	
4-Nov-11	10.7	3.5	1,300	4,060	
3-Aug-11	12.2	<2.17	1,290	3,600	
27-Apr-11	11.6	7.70	1,340	4,170	
25-Jan-11	19.1	<2.17	1,290	3,700	
20-Sep-10	19.6	<10.0	1,300	4,130	
27-Jun-10	14	<2.0	1,400	4,230	
6-Mar-10	23.7	<0.3	1,400	3,880	
16-Jan-10	22.6	0.4	1,300	3,630	
15-Sep-09	19.9	0.8	1,260	3,625	
3-Jun-09	29.4	0.4	1,340	3,905	
14-Mar-09	26.5	0.4	1,240	3,655	

**TABLE 5. DISCHARGE PLAN MONITORING WELL GROUNDWATER ANALYTICAL RESULTS
DONA ANA DAIRIES, DONA ANA COUNTY, NEW MEXICO**

Monitoring Well	Date Sampled	Nitrate as N (mg/l)	TKN (mg/l)	Chloride (mg/l)	TDS (mg/l)
624-04	28-Jan-20	Plugged and Abandoned			
	15-Nov-19	Dry			
	13-Aug-19	Dry			
	20-May-19	Dry			
	28-Feb-19	Dry			
	20-Nov-18	Dry			
	29-Aug-18	Dry			
	22-May-18	Dry			
	14-Feb-18	Dry			
	14-Nov-17	Dry			
	15-Aug-17	Dry			
	23-May-17	Dry			
	22-Feb-17	Dry			
	14-Nov-16	Dry			
	19-Aug-16	Dry			
	19-May-16	Dry			
	16-Feb-16	Dry			
	10-Nov-15	Dry			
	7-Aug-15	Dry			
	19-May-15	Dry			
	12-Feb-15	Dry			
	18-Nov-14	Dry			
	19-Aug-14	Dry			
	20-May-14	Dry			
	25-Feb-14	Dry			
	19-Nov-13	Dry			
	14-Aug-13	Dry			
	13-May-13	Dry			
	14-Feb-13	Dry			
	12-Nov-12	Dry			
	9-Aug-12	Dry			
	30-Apr-12	Dry			
	7-Feb-12	Dry			
4-Nov-11	Dry				
3-Aug-11	1.84	<2.17	478	2,760	
27-Apr-11	2.60	5.74	566	2,830	
26-Jan-11	3.23	2.52	747	3,480	
21-Sep-10	6.0	<10.0	758	3,750	
27-Jun-10	3.7	1.4	810	3,950	
6-Mar-10	4.3	0.4	890	4,050	
16-Jan-10	4.2	0.7	800	3,845	
15-Sep-09	9.3	0.8	840	3,750	
3-Jun-09	16.0	0.6	520	2,900	
14-Mar-09	18.1	0.6	520	2,820	

**TABLE 5. DISCHARGE PLAN MONITORING WELL GROUNDWATER ANALYTICAL RESULTS
DONA ANA DAIRIES, DONA ANA COUNTY, NEW MEXICO**

Monitoring Well	Date Sampled	Nitrate as N (mg/l)	TKN (mg/l)	Chloride (mg/l)	TDS (mg/l)
624-05	28-Jan-20	Plugged and Abandoned			
	15-Nov-19	11	<2.0	320	1,900
	13-Aug-19	8.1	<1.0	380	1,970
	16-May-19	7.7	<5.0	370	1,850
	28-Feb-19	6.6	<1.0	370	1,920
	20-Nov-18	Dry			
	29-Aug-18	Dry			
	22-May-18	Dry			
	14-Feb-18	Dry			
	14-Nov-17	Dry			
	15-Aug-17	Dry			
	23-May-17	Dry			
	22-Feb-17	Dry			
	14-Nov-16	Dry			
	19-Aug-16	Dry			
	19-May-16	Dry			
	16-Feb-16	Dry			
	10-Nov-15	Dry			
	7-Aug-15	Dry			
	19-May-15	Dry			
	12-Feb-15	Dry			
	18-Nov-14	Dry			
	19-Aug-14	Dry			
	20-May-14	Dry			
	25-Feb-14	Dry			
	19-Nov-13	Dry			
	14-Aug-13	Dry			
	13-May-13	Dry			
	14-Feb-13	6.72	<1.72	508	2,040
	12-Nov-12	4.82	<1.72	440	2,200
	9-Aug-12	4.11	1.82	472	2,050
	30-Apr-12	3.70	2.10	346	1,710
	7-Feb-12	3.38	<2.17	411	2,040
4-Nov-11	2.58	4.20	385	1,980	
3-Aug-11	3.34	<2.17	1,080	1,940	
27-Apr-11	3.34	4.76	424	1,840	
26-Jan-11	3.62	<2.17	392	1,740	
21-Sep-10	11.9	<10.0	449	2,300	
27-Jun-10	27	< 5.0	480	2,450	
6-Mar-10	30.5	0.4	520	2,595	
16-Jan-10	21.4	0.9	520	2,605	
15-Sep-09	34.8	1.0	530	2,620	
3-Jun-09	33.8	1.3	500	2,650	
14-Mar-09	23.9	1.2	490	2,565	

**TABLE 5. DISCHARGE PLAN MONITORING WELL GROUNDWATER ANALYTICAL RESULTS
DONA ANA DAIRIES, DONA ANA COUNTY, NEW MEXICO**

Monitoring Well	Date Sampled	Nitrate as N (mg/l)	TKN (mg/l)	Chloride (mg/l)	TDS (mg/l)
624-06	28-Jan-20	Plugged and Abandoned			
	15-Nov-19	Dry			
	13-Aug-19	Dry			
	20-May-19	Dry			
	28-Feb-19	Dry			
	20-Nov-18	Dry			
	29-Aug-18	Dry			
	22-May-18	Dry			
	14-Feb-18	Dry			
	14-Nov-17	Dry			
	15-Aug-17	Dry			
	23-May-17	Dry			
	22-Feb-17	Dry			
	14-Nov-16	Dry			
	19-Aug-16	Dry			
	19-May-16	Dry			
	16-Feb-16	Dry			
	10-Nov-15	Dry			
	7-Aug-15	Dry			
	19-May-15	Dry			
	12-Feb-15	Dry			
	18-Nov-14	Dry			
	19-Aug-14	Dry			
	20-May-14	Dry			
	25-Feb-14	Dry			
	19-Nov-13	Dry			
	14-Aug-13	Dry			
	13-May-13	Dry			
	14-Feb-13	31.5	<1.72	1,150	3,600
	12-Nov-12	28.3	<1.72	1,060	3,840
	9-Aug-12	30.8	7.56	1,080	3,420
	30-Apr-12	31.1	8.40	1,010	3,300
	7-Feb-12	30.9	6.30	1,080	3,020
4-Nov-11	29.5	8.68	1,040	2,860	
3-Aug-11	29.8	<2.17	1,080	3,240	
27-Apr-11	29.0	3.50	1,050	3,180	
26-Jan-11	29.1	2.94	1,080	2,760	
21-Sep-10	26.7	<10.0	1,060	3,270	
27-Jun-10	30	<5.0	1,100	3,570	
6-Mar-10	28.3	<0.3	1,250	3,550	
16-Jan-10	52.2	0.6	2,100	3,545	
15-Sep-09	27.8	0.7	1,150	3,425	
3-Jun-09	38.3	0.8	70	4,300	
14-Mar-09	36.5	0.3	1,300	3,800	

**TABLE 5. DISCHARGE PLAN MONITORING WELL GROUNDWATER ANALYTICAL RESULTS
DONA ANA DAIRIES, DONA ANA COUNTY, NEW MEXICO**

Monitoring Well	Date Sampled	Nitrate as N (mg/l)	TKN (mg/l)	Chloride (mg/l)	TDS (mg/l)
624-07	28-Jan-20	Plugged and Abandoned			
	15-Nov-19	Dry			
	13-Aug-19	Dry			
	20-May-19	Dry			
	28-Feb-19	Dry			
	20-Nov-18	Dry			
	29-Aug-18	Dry			
	22-May-18	Dry			
	14-Feb-18	Dry			
	14-Nov-17	Dry			
	15-Aug-17	Not Sampled - insufficient water to sample			
	23-May-17	Not Sampled - insufficient water to sample			
	22-Feb-17	Not Sampled - insufficient water to sample			
	14-Nov-16	Not Sampled - insufficient water to sample			
	19-Aug-16	Not Sampled - insufficient water to sample			
	19-May-16	Not Sampled - insufficient water to sample			
	16-Feb-16	Dry			
	10-Nov-15	Not Sampled - insufficient water to sample			
	7-Aug-15	Not Sampled - insufficient water to sample			
	19-May-15	Not Sampled - insufficient water to sample			
	12-Feb-15	Not Sampled - insufficient water to sample			
	17-Nov-14	Dry			
	19-Aug-14	Not Sampled - insufficient water to sample			
	20-May-14	Dry			
	26-Feb-14	Not Sampled - insufficient water to sample			
	19-Nov-13	Dry			
	14-Aug-13	Dry			
	13-May-13	Dry			
	14-Feb-13	Dry			
	12-Nov-12	Dry			
	9-Aug-12	Dry			
	30-Apr-12	Dry			
	7-Feb-12	Not Sampled - insufficient water to sample			
	4-Nov-11	Not Sampled - insufficient water to sample			
	3-Aug-11	8.01	<2.17	473	1,600
	27-Apr-11	19.4	3.50	539	2,290
	26-Jan-11	14.7	5.60	516	1,900
	21-Sep-10	20.5	<10.0	531	2,200
	27-Jun-10	61	<5.0	880	3,550
	6-Mar-10	43.4	<0.3	1,080	3,825
16-Jan-10	49.5	0.5	840	3,275	
15-Sep-09	50.1	0.4	960	3,280	
3-Jun-09	75.2	0.8	1,525	4,980	
14-Mar-09	54.3	0.3	1,160	3,580	

**TABLE 5. DISCHARGE PLAN MONITORING WELL GROUNDWATER ANALYTICAL RESULTS
DONA ANA DAIRIES, DONA ANA COUNTY, NEW MEXICO**

Monitoring Well	Date Sampled	Nitrate as N (mg/l)	TKN (mg/l)	Chloride (mg/l)	TDS (mg/l)
624-08	28-Jan-20	Plugged and Abandoned			
	15-Nov-19	Dry			
	13-Aug-19	Dry			
	16-May-19	Dry			
	28-Feb-19	Dry			
	20-Nov-18	Dry			
	29-Aug-18	Dry			
	22-May-18	Dry			
	14-Feb-18	Dry			
	14-Nov-17	Dry			
	15-Aug-17	Dry			
	23-May-17	Dry			
	22-Feb-17	Dry			
	14-Nov-16	Dry			
	19-Aug-16	Dry			
	19-May-16	Dry			
	16-Feb-16	Dry			
	10-Nov-15	Dry			
	7-Aug-15	Dry			
	19-May-15	Dry			
	12-Feb-15	Dry			
	18-Nov-14	Dry			
	19-Aug-14	Dry			
	20-May-14	Dry			
	26-Feb-14	Dry			
	19-Nov-13	Dry			
	14-Aug-13	Dry			
	13-May-13	Dry			
	14-Feb-13	Dry			
	9-Aug-12	Dry			
	30-Apr-12	Dry			
	7-Feb-12	Dry			
	4-Nov-11	Dry			
	3-Aug-11	Dry			
27-Apr-11	2.45	3.50	200	1,400	
26-Jan-11	1.7	8.12	222	2,940	
21-Sep-10	<2.50	<10.0	197	1,200	
27-Jun-10	2.0	<1.0	220	1,310	
6-Mar-10	0.65	<0.3	280	1,330	
16-Jan-10	0.89	<0.3	240	1,215	
15-Sep-09	2.3	0.3	200	1,205	
3-Jun-09	1.7	0.7	210	1,280	
14-Mar-09	1.8	<0.2	205	1,165	

**TABLE 5. DISCHARGE PLAN MONITORING WELL GROUNDWATER ANALYTICAL RESULTS
DONA ANA DAIRIES, DONA ANA COUNTY, NEW MEXICO**

Monitoring Well	Date Sampled	Nitrate as N (mg/l)	TKN (mg/l)	Chloride (mg/l)	TDS (mg/l)
624-09	11-May-23	<1.0	<1.0	250	1,470
	16-Feb-23	<1.0	<1.0	180	1,050
	14-Nov-22	<1.0	<1.0	140	1,020
	15-Aug-22	<0.50	<1.0	140	1,180
	13-May-22	2.4	1.7	270	1,700
	18-Feb-22	1.6	1.1	310	1,880
	10-Nov-21	2.8	1.5	370	2,010
	12-Aug-21	2.6	<2.0	380	2,070
	12-May-21	6.8	1.5	440	2,420
	19-Feb-21	13	11	600	2,820
	13-Nov-20	1.3	3.6	260	1,440
	17-Aug-20	3.5	2.5	370	1,970
	14-May-20	<1.0	2.2	320	1,480
	13-Feb-20	<1.0	<2.0	320	2,130
624-10	11-May-23	<1.0	1.1	690	3,240
	16-Feb-23	<1.0	<1.0	550	2,860
	14-Nov-22	<1.0	1.1	510	2,760
	12-Aug-22	<1.0	<1.0	480	2,690
	12-May-22	5.8	<1.0	410	2,420
	18-Feb-22	14	<2.0	390	2,200
	10-Nov-21	8.9	1.7	440	2,330
	12-Aug-21	19	13	350	2,190
	12-May-21	17	<2.0	420	2,320
	19-Feb-21	2.9	<2.0	540	2,690
	13-Nov-20	2.3	1.4	500	2,710
	17-Aug-20	5.7	<2.0	520	2,700
	14-May-20	2.3	<2.0	490	2,640
13-Feb-20	4.2	8.7	450	2,720	
624-11	12-May-23	8.9	<1.0	1,300	3,600
	17-Feb-23	10	<1.0	1,200	3,500
	11-Nov-22	8.8	<1.0	1,200	3,500
	12-Aug-22	9.2	<1.0	1,100	3,230
	12-May-22	9.6	<1.0	1,000	3,340
	18-Feb-22	9.7	1.1	1,100	3,220
	11-Nov-21	9.8	<1.0	1,000	3,330
	27-Aug-21	14	<2.0	1,000	3,320
	14-May-21	11	<2.0	1,100	3,330
	19-Feb-21	11	<2.0	1,100	3,300
	12-Nov-20	11	2.2	1,100	3,200
	17-Aug-20	11	<2.0	1,200	3,440
	15-May-20	12	<2.0	1,200	3,510
13-Feb-20	9.2	7.0	910	3,650	

**TABLE 5. DISCHARGE PLAN MONITORING WELL GROUNDWATER ANALYTICAL RESULTS
DONA ANA DAIRIES, DONA ANA COUNTY, NEW MEXICO**

Monitoring Well	Date Sampled	Nitrate as N (mg/l)	TKN (mg/l)	Chloride (mg/l)	TDS (mg/l)
Gonzalez					
177-01	7-Aug-19	16	<2.0	1,500	4,260
	20-May-19	18	<2.0	1,600	4,230
	27-Feb-19	17	<2.0	1,600	4,290
	15-Nov-18	19	<2.0	1,500	4,250
	21-Aug-18	17	<2.0	1,400	4,350
	22-May-18	19	<2.0	1,500	4,260
	14-Feb-18	18	<2.0	1,600	4,310
	10-Nov-17	16.2	0.750	1,400	4,130
	14-Aug-17	20.2	1.21	1,400	4,220
	22-May-17	22.5	<0.0501	1,370	4,200
	22-Feb-17	24.0	<0.0501	1,380	4,330
	10-Nov-16	23.7	<0.937	1,380	4,090
	23-Aug-16	23.4	<0.937	1,420	4,030
	20-May-16	25.6	4.04	1,370	4,400
	11-Feb-16	28.9	1.68	1,400	4,100
	11-Nov-15	30.3	<1.18	1,370	4,260
	21-Aug-15	12.0	1.40	1,410	4,220
	13-May-15	30.4	<1.18	1,370	4,160
	11-Feb-15	33.5	<1.80	1,190	4,160
	13-Nov-14	34.6	<1.80	1,330	3,780
	18-Aug-14	30.5	2.80	1,100	3,780
	16-May-14	33.8	<1.80	1,380	3,840
	21-Feb-14	33.7	<1.66	1,310	3,870
	18-Nov-13	33.2	2.80	1,330	3,740
	13-Aug-13	32.2	4.20	1,370	3,850
	15-May-13	31.6	<1.66	1,300	3,940
	19-Feb-13	28.4	<1.72	1,310	3,930
	13-Nov-12	27.7	<1.72	1,190	3,780
	13-Aug-12	27.3	2.52	1,160	3,790
	26-Apr-12	28.5	<1.72	1,460	3,500
	6-Feb-12	28.1	<2.17	1,180	3,650
	3-Nov-11	27.4	2.66	1,170	3,790
	2-Aug-11	26.0	2.24	1,200	4,000
4-May-11	26.6	<2.17	1,160	4,020	
25-Jan-11	23.3	4.06	1,160	3,540	
20-Sep-10	17.6	12.7	1,120	3,480	
29-Jun-10	34	<1.0	1,200	3,660	
28-Apr-10	31	<5.0	1,200	3,680	
20-Jan-10	32	<5.0	1,200	3,640	
21-Oct-09	35	<5.0	1,100	3,700	
7-Jul-09	35	<5.0	1,400	3,700	
6-May-09	34	<5.0	1,300	3,700	
22-Jan-09	33	<5.0	1,300	3,700	

**TABLE 5. DISCHARGE PLAN MONITORING WELL GROUNDWATER ANALYTICAL RESULTS
DONA ANA DAIRIES, DONA ANA COUNTY, NEW MEXICO**

Monitoring Well	Date Sampled	Nitrate as N (mg/l)	TKN (mg/l)	Chloride (mg/l)	TDS (mg/l)
177-02	7-Aug-19	7.7	<1.0	290	1,590
177-02	20-May-19	9.8	<2.0	380	1,800
177-02	27-Feb-19	15	<2.0	580	2,380
177-02	15-Nov-18	7.3	<1.0	280	1,590
177-02	21-Aug-18	15	2.2	590	2,480
177-02	22-May-18	4.7	<1.0	200	1,460
177-02	14-Feb-18	7.4	<1.0	330	1,940
177-02	10-Nov-17	7.89	0.901	247	1,820
177-02	14-Aug-17	24.5	<0.0500	1,050	3,300
177-02	22-May-17	27.4	<0.0501	1,010	3,090
177-02	22-Feb-17	25.0	0.389	911	2,960
177-02	10-Nov-16	20.4	1.14	894	2,800
177-02	23-Aug-16	21.9	<0.937	967	2,980
177-02	20-May-16	22.1	<2.24	798	3,040
177-02	11-Feb-16	24.4	<1.18	847	2,820
177-02	11-Nov-15	20.3	<1.18	824	2,800
177-02	21-Aug-15	18.2	<1.18	797	2,840
177-02	13-May-15	17.3	1.40	923	2,980
177-02	12-Feb-15	17.5	<1.80	835	3,160
177-02	14-Nov-14	16.3	<1.80	931	2,930
177-02	18-Aug-14	17.1	<1.80	864	2,810
177-02	16-May-14	43.0	<1.80	803	2,980
177-02	21-Feb-14	67.9	<1.66	725	3,180
177-02	18-Nov-13	111	2.80	682	3,150
177-02	13-Aug-13	30.7	4.20	794	3,020
177-02	15-May-13	27.6	<1.66	910	3,000
177-02	19-Feb-13	29.3	<1.72	902	3,100
177-02	13-Nov-12	35.8	<1.72	870	3,320
177-02	13-Aug-12	47.4	7.70	899	3,650
177-02	26-Apr-12	36.0	<1.72	881	2,960
177-02	6-Feb-12	37.0	<2.17	958	3,320
177-02	3-Nov-11	32.7	<2.17	971	3,450
177-02	3-Aug-11	34.4	2.80	997	3,340
177-02	4-May-11	38.1	2.52	1,050	3,580
177-02	25-Jan-11	31.6	3.36	1,050	3,640
177-02	20-Sep-10	78.0	<10.0	964	3,630
177-02	29-Jun-10	58	<1.0	1,000	3,830
177-02	28-Apr-10	60	<5.0	1,100	3,860
177-02	20-Jan-10	59	<5.0	1,200	4,020
177-02	21-Oct-09	50	<5.0	1,200	4,000
177-02	7-Jul-09	56	<5.0	1,300	4,000
177-02	6-May-09	52	<5.0	1,200	4,000
177-02	22-Jan-09	72	<5.0	1,300	4,000

**TABLE 5. DISCHARGE PLAN MONITORING WELL GROUNDWATER ANALYTICAL RESULTS
DONA ANA DAIRIES, DONA ANA COUNTY, NEW MEXICO**

Monitoring Well	Date Sampled	Nitrate as N (mg/l)	TKN (mg/l)	Chloride (mg/l)	TDS (mg/l)
177-03A	13-Aug-19	14	<2.0	670	2,800
	20-May-19	15	<2.0	690	2,670
	27-Feb-19	14	<2.0	680	2,770
	20-Nov-18	12	<2.0	590	2,700
	21-Aug-18	2.9	<1.0	400	1,800
	22-May-18	13	<2.0	700	2,650
	15-Feb-18	3.70	<1.0	510	1,770
	10-Nov-17	2.76	2.29	455	2,010
	15-Aug-17	8.78	1.58	526	2,860
	22-May-17	7.50	0.362	601	2,440
	23-Feb-17	7.69	<0.0501	693	2,670
	11-Nov-16	7.30	<0.937	333	2,540
	24-Aug-16	14.9	<0.937	1,130	3,990
	20-May-16	5.41	<2.24	768	2,620
	12-Feb-16	16.9	<1.18	1,270	4,220
	11-Nov-15	5.67	<1.18	821	2,760
	21-Aug-15	6.35	<1.18	745	2,600
	14-May-15	9.94	<1.18	871	2,900
	11-Feb-15	17.7	<1.80	1,020	3,880
	13-Nov-14	0.993	<1.80	486	1,780
	19-Aug-14	10.9	<1.80	859	2,720
	19-May-14	11.4	<1.80	950	3,220
	24-Feb-14	15.6	2.10	1,160	3,900
	18-Nov-13	14.3	2.10	1,150	3,490
	13-Aug-13	17.1	2.80	1,230	4,120
	15-May-13	16.0	<1.66	1,150	3,530
	18-Feb-13	15.5	<1.72	1,290	3,900
	13-Nov-12	12.2	<1.72	1,150	3,900
	13-Aug-12	7.86	<1.72	835	2,810
	26-Apr-12	1.16	<1.72	378	1,430
6-Feb-12	2.00	<2.17	452	1,580	
4-Nov-11	<0.500	3.50	436	1,850	

**TABLE 5. DISCHARGE PLAN MONITORING WELL GROUNDWATER ANALYTICAL RESULTS
DONA ANA DAIRIES, DONA ANA COUNTY, NEW MEXICO**

Monitoring Well	Date Sampled	Nitrate as N (mg/l)	TKN (mg/l)	Chloride (mg/l)	TDS (mg/l)
177-04	13-Aug-19	14	<2.0	830	3,210
	20-May-19	14	<2.0	840	3,200
	27-Feb-19	16	<2.0	930	3,370
	20-Nov-18	15	<2.0	880	3,400
	21-Aug-18	15	<2.0	810	3,450
	22-May-18	16	<2.0	900	3,590
	15-Feb-18	16	<2.0	1,000	3,640
	10-Nov-17	16.2	2.46	983	3,390
	16-Aug-17	17.0	<0.0500	1,090	3,700
	22-May-17	16.4	0.921	1,130	3,880
	23-Feb-17	18.0	<0.0501	1,140	3,810
	11-Nov-16	14.8	<0.937	1,040	4,020
	24-Aug-16	14.5	<0.937	647	4,220
	23-May-16	0.329	<2.24	378	1,440
	12-Feb-16	49.8	<1.18	1,070	4,080
	11-Nov-15	19.3	7.28	1,360	4,080
	21-Aug-15	7.50	<1.18	1,420	4,040
	14-May-15	19.4	<1.18	1,330	3,910
	12-Feb-15	18.7	<1.80	1,110	3,730
	13-Nov-14	22.5	<1.80	1,190	3,680
	19-Aug-14	18.2	<1.80	1,150	3,830
	19-May-14	17.5	<1.80	1,320	3,970
	24-Feb-14	17.6	<1.66	1,290	4,020
	18-Nov-13	23.0	2.80	1,260	3,850
	13-Aug-13	19.1	2.10	1,270	3,530
	15-May-13	19.4	<1.66	1,110	3,600
	18-Feb-13	20.5	<1.72	1,120	3,450
	13-Nov-12	22.3	<1.72	1,070	3,630
	13-Aug-12	19.7	<1.72	1,000	3,720
	26-Apr-12	21.7	<1.72	1,050	3,480
	2-Feb-12	22.5	<2.17	1,100	3,650
	3-Nov-11	27.5	<2.17	1,100	3,500
	2-Aug-11	21.6	<2.17	1,080	3,670
	4-May-11	21.2	3.64	1,100	3,740
	25-Jan-11	17.5	2.38	1,150	3,760
	20-Sep-10	4.83	<10.0	1,180	4,030
	29-Jun-10	26	<1.0	1,200	4,010
	28-Apr-10	26	<5.0	1,300	4,090
	20-Jan-10	27	<5.0	1,400	4,090
	21-Oct-09	29	<5.0	1,400	4,100
7-Jul-09	32	<5.0	1,400	3,990	
6-May-09	32	<5.0	1,300	3,800	
22-Jan-09	26	<5.0	1,200	1,700	

**TABLE 5. DISCHARGE PLAN MONITORING WELL GROUNDWATER ANALYTICAL RESULTS
DONA ANA DAIRIES, DONA ANA COUNTY, NEW MEXICO**

Monitoring Well	Date Sampled	Nitrate as N (mg/l)	TKN (mg/l)	Chloride (mg/l)	TDS (mg/l)
177-05	13-Aug-19	24	<5.0	1,400	4,180
	20-May-19	30	<5.0	1,400	4,080
	27-Feb-19	24	<5.0	1,400	4,090
	20-Nov-18	27	<5.0	1,300	4,020
	21-Aug-18	28	<5.0	1,300	4,260
	22-May-18	32	<5.0	1,300	4,240
	15-Feb-18	33	<5.0	1,600	4,380
	10-Nov-17	30.8	0.112	1,350	4,100
	15-Aug-17	36.2	0.605	1,450	4,490
	22-May-17	31.2	0.621	1,390	4,250
	23-Feb-17	50.2	<0.0501	1,170	3,550
	11-Nov-16	27.4	<0.937	1,170	3,900
	24-Aug-16	25.4	<0.937	1,340	3,930
	20-May-16	27.4	<2.24	1,290	4,030
	12-Feb-16	17.8	3.36	1,380	3,330
	11-Nov-15	30.8	7.28	1,230	3,840
	21-Aug-15	34.0	<1.18	1,300	3,920
	13-May-15	46.5	<1.18	1,110	3,440
	11-Feb-15	36.8	<1.80	1,250	4,060
	13-Nov-14	56.1	<1.80	1,110	3,260
	19-Aug-14	18.1	<1.80	1,680	4,800
	19-May-14	35.7	<1.80	1,400	4,000
	24-Feb-14	26.6	<1.66	1,600	4,460
	18-Nov-13	33.5	2.10	1,580	4,360
	13-Aug-13	30.5	2.80	1,640	4,420
	15-May-13	29.8	<1.66	1,510	4,160
	18-Feb-13	32.6	<1.72	1,430	3,900
	13-Nov-12	37.1	<1.72	1,240	4,050
	13-Aug-12	37.6	2.66	1,390	4,360
	26-Apr-12	47.1	<1.72	1,090	3,440
	2-Feb-12	42.2	<2.17	1,170	3,590
	3-Nov-11	30.6	<2.17	1,190	3,060
	2-Aug-11	36.3	<2.17	1,120	3,420
	4-May-11	40.6	5.60	1,090	3,500
25-Jan-11	39.2	2.10	1,060	3,240	
20-Sep-10	7.39	<10.0	1,050	3,500	
29-Jun-10	39	<1.0	1,100	3,470	
28-Apr-10	40	<5.0	1,200	3,460	
20-Jan-10	43	<5.0	1,100	3,330	
21-Oct-09	50	<5.0	1,100	3,300	
7-Jul-09	38	<5.0	1,200	3,270	
6-May-09	40	<5.0	1,100	3,100	
22-Jan-09	40	<5.0	1,100	3,000	

**TABLE 5. DISCHARGE PLAN MONITORING WELL GROUNDWATER ANALYTICAL RESULTS
DONA ANA DAIRIES, DONA ANA COUNTY, NEW MEXICO**

Monitoring Well	Date Sampled	Nitrate as N (mg/l)	TKN (mg/l)	Chloride (mg/l)	TDS (mg/l)	
177-06	13-Aug-19				Dry	
	8-May-19				Dry	
	27-Feb-19				Dry	
	20-Nov-18				Dry	
	21-Aug-18				Dry	
	22-May-18				Dry	
	15-Feb-18				Dry	
	10-Nov-17				Dry	
	14-Aug-17				Dry	
	22-May-17				Dry	
	23-Feb-17				Dry	
	11-Nov-16				Dry	
	24-Aug-16				Dry	
	23-May-16				Dry	
	12-Feb-16				Dry	
	11-Nov-15				Dry	
	21-Aug-15				Dry	
	13-May-15				Dry	
	11-Feb-15				Dry	
	13-Nov-14				Dry	
	13-Aug-14				Dry	
	13-Aug-14				Dry	
	19-May-14				Dry	
	24-Feb-14				Dry	
	21-Nov-13	24.1	14.0	1,080	3,110	
	18-Nov-13	Not Sampled - insufficient water to sample				
	13-Aug-13	Not Sampled - insufficient water to sample				
	15-May-13	Not Sampled - insufficient water to sample				
	18-Feb-13	17.4	<1.72	963	3,000	
	13-Nov-12	16.1	<1.72	918	3,020	
	26-Apr-12	Dry				
	2-Feb-12	16.1	4.76	934	2,940	
	7-Dec-11	15.1	<2.17	892	2,760	
	2-Aug-11	16.1	<2.17	910	3,020	
	4-May-11	17.2	4.90	955	2,930	
	25-Jan-11	19.2	<2.05	923	2,740	
	20-Sep-10	<2.50	<10.0	890	2,880	
	29-Jun-10	23	<1.0	940	2,960	
	28-Apr-10	21	<5.0	980	2,960	
	20-Jan-10	26	<5.0	1,000	2,910	
21-Oct-09	25	<5.0	980	2,900		
7-Jul-09	25	<5.0	1,000	2,850		
6-May-09	25	<5.0	1,000	2,800		
22-Jan-09	23	<5.0	960	2,800		

**TABLE 5. DISCHARGE PLAN MONITORING WELL GROUNDWATER ANALYTICAL RESULTS
DONA ANA DAIRIES, DONA ANA COUNTY, NEW MEXICO**

Monitoring Well	Date Sampled	Nitrate as N (mg/l)	TKN (mg/l)	Chloride (mg/l)	TDS (mg/l)
177-07	15-Mar-03	44.4	1.5	1,205	4,007
177-07R	7-Aug-19	22	<5.0	790	3,000
	20-May-19	23	<5.0	850	3,030
	27-Feb-19	25	<5.0	860	3,110
	20-Nov-18	25	<5.0	840	3,170
	21-Aug-18	26	<5.0	920	3,380
	22-May-18	28	<5.0	1,000	3,490
	14-Feb-18	28	<5.0	1,000	3,500
	10-Nov-17	30.2	<0.0500	1,070	3,330
	14-Aug-17	32.6	<0.0500	1,100	3,680
	22-May-17	29.5	<0.0501	1,080	3,680
	23-Feb-17	38.5	<0.0501	1,070	3,550
	11-Nov-16	35.2	<0.937	1,020	3,560
	23-Aug-16	40.0	<0.937	2,250	3,650
	23-May-16	42.1	<2.24	1,040	3,580
	11-Feb-16	39.5	<1.18	1,100	3,600
	11-Nov-15	37.1	12.9	1,110	3,480
	21-Aug-15	35.0	<1.18	1,170	3,600
	14-May-15	45.1	<1.18	1,130	3,580
	12-Feb-15	46.9	<1.80	1,070	3,510
	14-Nov-14	45.3	<1.80	1,070	3,250
	19-Aug-14	28.2	<1.80	980	3,120
	19-May-14	22.7	2.10	895	2,910
	24-Feb-14	22.7	<1.66	903	3,080
	18-Nov-13	21.5	2.10	911	3,060
	13-Aug-13	30.3	2.80	1,010	3,540
	15-May-13	29.2	<1.66	1,000	3,420
	19-Feb-13	31.0	<1.72	976	3,360
	13-Nov-12	31.0	<1.72	1,040	3,570
13-Aug-12	26.5	<1.72	1,040	3,670	
26-Apr-12	22.8	<1.72	1,010	2,690	
6-Feb-12	28.5	5.60	1,060	2,730	
4-Nov-11	29.3	2.66	1,050	2,830	
3-Aug-11	25.2	2.80	1,050	3,250	
7-Apr-11	21.4	2.52	1,070	8,660	
NMWQCC Standard		10	NA	250	1,000
Existing Conditions - August 2020		NA	NA	1,800	1,598
Existing Conditions - Pre-August 2020*		NA	NA	1,015	3,178

**TABLE 5. DISCHARGE PLAN MONITORING WELL GROUNDWATER ANALYTICAL RESULTS
DONA ANA DAIRIES, DONA ANA COUNTY, NEW MEXICO**

Monitoring Well	Date Sampled	Nitrate as N (mg/l)	TKN (mg/l)	Chloride (mg/l)	TDS (mg/l)
Central Area					
Buena Vista Dairy II					
74-01	15-May-23	43	<5.0	770	2,950
	17-Feb-23	29	<5.0	770	2,980
	15-Nov-22	27	<5.0	800	2,980
	16-Aug-22	25	<5.0	800	3,000
	13-May-22	15	<2.0	780	3,020
	22-Feb-22	7.2	<1.0	850	2,940
	12-Nov-21	17	<2.0	880	3,130
	7-Sep-21	35	<5.0	900	3,410
	17-May-21	11	<2.0	980	3,590
	22-Feb-21	8.6	3.6	1,100	3,940
	17-Nov-20	5.9	3.9	1,200	9,800
	21-Aug-20	17	<2.0	820	2,790
	18-May-20	66	<5.0	1,100	3,570
	14-Feb-20	72	<5.0	1,200	4,050
	19-Nov-19	68	<5.0	1,100	3,960
	14-Aug-19	24	<5.0	820	2,910
	21-May-19	39	<5.0	850	3,110
	28-Feb-19	52	<5.0	930	3,460
	16-Nov-18	65	<5.0	1,100	3,820
	29-Aug-18	64	<5.0	1,100	3,000
	23-May-18	34	<5.0	790	3,140
	19-Feb-18	49	<5.0	960	3,290
	14-Nov-17	41.5	<0.0500	871	3,100
	16-Aug-17	56.7	<0.0500	1,030	3,590
	26-May-17	26.2	<0.0501	756	2,810
	24-Feb-17	35.2	<0.300	799	3,060
	14-Nov-16	46.8	<0.937	702	3,360
	24-Aug-16	60.2	<0.937	1,000	3,690
	25-May-16	51.1	<2.24	739	3,060
	18-Feb-16	32.1	<1.18	763	2,840
	12-Nov-15	15.9	12.3	725	2,630
	24-Aug-15	67.4	<1.18	902	3,360
	19-May-15	59.2	2.80	784	3,060
	13-Feb-15	59.9	<1.80	812	3,160
	19-Nov-14	23.9	<1.80	891	2,930
	20-Aug-14	76.2	<1.80	866	3,480
	20-May-14	62.6	2.10	816	3,080
	3-Mar-14	57.2	2.10	855	3,200
	19-Nov-13	63.6	4.20	898	3,210
	21-Aug-13	63.9	2.80	829	3,180
	16-May-13	72.3	<1.66	816	3,090
19-Feb-13	59.1	<1.72	840	3,140	
14-Nov-12	94.2	8.40	963	3,510	
10-Aug-12	78.6	3.50	922	2,150	
3-May-12	65.3	<1.72	778	3,265	
8-Feb-12	Not Sampled				
3-Nov-11	64.6	<2.17	811	2,830	
1-Aug-11	73.2	<2.17	770	3,040	
26-Apr-11	67.8	<2.17	730	3,300	
25-Jan-11	41.7	13.0	738	2,960	
17-Sep-10	36.7	<10.0	695	2,760	
29-Jun-10	74	<1.0	850	3,350	
24-Mar-10	70	ND	840	3,070	
14-Dec-09	84	0.14	750	2,480	
1-Sep-09	92	ND	730	2,914	
2-Jun-09	33.2	ND	650	2,632	
3-Mar-09	43.8	ND	735	2,666	

**TABLE 5. DISCHARGE PLAN MONITORING WELL GROUNDWATER ANALYTICAL RESULTS
DONA ANA DAIRIES, DONA ANA COUNTY, NEW MEXICO**

Monitoring Well	Date Sampled	Nitrate as N (mg/l)	TKN (mg/l)	Chloride (mg/l)	TDS (mg/l)
74-02	12-May-23	1.3	2.2	650	2,500
	17-Feb-23	4.3	1.3	670	2,440
	14-Nov-22	<1.0	1.8	620	2,460
	15-Aug-22	<0.50	1.8	680	2,480
	13-May-22	<1.0	2.2	630	2,430
	22-Feb-22	<1.0	2.2	650	2,360
	11-Nov-21	<1.0	3.4	600	2,470
	7-Sep-21	<0.50	2.2	690	2,550
	14-May-21	<1.0	7.8	650	3,220
	22-Feb-21	<1.0	4.2	650	9,470
	17-Nov-20	30	13	510	18,900
	21-Aug-20	44	<5.0	600	2,410
	15-May-20	43	<5.0	610	2,430
	14-Feb-20	43	<5.0	640	2,540
	19-Nov-19	37	<5.0	640	2,630
	14-Aug-19	38	<5.0	560	2,310
	21-May-19	37	<5.0	600	2,380
	28-Feb-19	36	<5.0	560	2,400
	15-Nov-18	31	<5.0	550	2,230
	23-Aug-18	27	<5.0	490	2,220
	23-May-18	33	<5.0	560	2,360
	15-Feb-18	26	<5.0	640	2,260
	14-Nov-17	23.5	<0.0500	521	2,110
	15-Aug-17	23.5	<0.0500	539	2,100
	25-May-17	25.6	<0.0501	548	2,470
	24-Feb-17	33.4	<0.300	587	2,240
	14-Nov-16	34.4	7.95	603	2,440
	24-Aug-16	37.6	<0.937	581	2,480
	25-May-16	40.7	<2.24	593	2,480
	18-Feb-16	29.9	<1.18	592	2,420
	11-Nov-15	22.5	14.0	562	2,120
	24-Aug-15	26.1	<1.18	566	2,270
	19-May-15	20.7	1.40	527	2,180
	13-Feb-15	23.5	<1.80	519	2,300
	19-Nov-14	28.6	<1.80	572	2,230
	20-Aug-14	29.8	<1.80	567	2,360
	20-May-14	25.7	2.10	579	2,230
	3-Mar-14	24.7	<1.66	588	2,260
	20-Nov-13	28.8	2.10	625	2,340
	21-Aug-13	20.0	2.80	564	2,220
16-May-13	15.5	<1.66	549	2,120	
19-Feb-13	13.9	<1.72	525	1,900	
14-Nov-12	12.7	2.10	484	2,150	
10-Aug-12	14.0	2.10	532	2,060	
3-May-12	16.4	<1.72	495	1,980	
8-Feb-12	15.2	5.46	519	2,150	
3-Nov-11	26.3	<2.17	558	2,510	
29-Jul-11	52.8	2.24	630	2,710	
26-Apr-11	93.2	<2.17	831	3,610	
25-Jan-11	65.7	2.80	824	3,670	
17-Sep-10	30.6	<10.0	665	2,400	
29-Jun-10	45	<1.0	730	2,780	
24-Mar-10	20.6	ND	810	2,612	
14-Dec-09	14.6	0.14	770	2,452	
1-Sep-09	17.3	0.7	760	2,474	
2-Jun-09	17.6	0.84	820	4,866	
3-Mar-09	45.1	ND	1,265	4,556	

**TABLE 5. DISCHARGE PLAN MONITORING WELL GROUNDWATER ANALYTICAL RESULTS
DONA ANA DAIRIES, DONA ANA COUNTY, NEW MEXICO**

Monitoring Well	Date Sampled	Nitrate as N (mg/l)	TKN (mg/l)	Chloride (mg/l)	TDS (mg/l)
74-03	12-May-23	<1.0	<1.0	250	1,670
	17-Feb-23	2.7	<1.0	300	1,690
	14-Nov-22	1.2	<1.0	220	1,490
	15-Aug-22	0.61	<1.0	240	1,360
	13-May-22	<1.0	<1.0	200	1,240
	22-Feb-22	<1.0	<1.0	250	1,340
	11-Nov-21	<1.0	<1.0	230	1,420
	27-Aug-21	<1.0	<1.0	240	1,570
	14-May-21	<1.0	<1.0	250	1,440
	22-Feb-21	<1.0	<1.0	260	1,500
	17-Nov-20	<0.50	<1.0	250	1,460
	19-Aug-20	<1.0	<1.0	240	1,570
	15-May-20	<1.0	<1.0	260	1,570
	14-Feb-20	<1.0	<2.0	260	1,510
	19-Nov-19	<1.0	<2.0	230	1,550
	14-Aug-19	<1.0	<2.0	260	1,520
	21-May-19	<1.0	<1.0	260	1,390
	28-Feb-19	<1.0	<1.0	250	1,550
	15-Nov-18	1.0	<1.0	300	1,760
	23-Aug-18	1.2	<1.0	360	1,900
	23-May-18	1.4	<1.0	430	2,000
	15-Feb-18	1.4	<1.0	530	2,100
	14-Nov-17	1.21	0.0626	548	2,340
	15-Aug-17	0.187	1.35	514	2,150
	25-May-17	0.941	0.187	641	2,640
	24-Feb-17	0.209	<0.300	668	2,520
	14-Nov-16	1.25	<0.937	654	2,500
	24-Aug-16	3.36	2.27	728	2,590
	25-May-16	0.646	<2.24	693	2,780
	18-Feb-16	<0.194	<1.18	804	2,920
	12-Nov-15	<0.194	3.36	1,000	3,480
	24-Aug-15	<0.194	<1.18	1,190	3,960
	19-May-15	1.02	1.40	1,310	4,300
	13-Feb-15	1.07	<1.80	1,260	4,330
	19-Nov-14	2.06	<1.80	1,380	4,390
	20-Aug-14	2.77	<1.80	1,240	4,380
	20-May-14	3.51	2.10	1,230	4,000
	3-Mar-14	5.75	<1.66	1,220	4,140
	20-Nov-13	10.7	2.80	1,200	4,070
	21-Aug-13	5.62	3.50	1,230	4,100
16-May-13	7.88	<1.66	1,160	3,920	
19-Feb-13	2.81	<1.72	1,250	4,480	
14-Nov-12	1.06	<1.72	1,300	4,440	
10-Aug-12	2.25	<1.72	1,450	4,900	
3-May-12	9.92	<1.72	1,330	3,920	
8-Feb-12	11.0	<2.17	1,420	4,170	
3-Nov-11	27.6	<2.17	1,420	4,730	
1-Aug-11	15.0	<2.17	1,450	4,870	
26-Apr-11	4.17	<2.17	1,480	4,690	
25-Jan-11	2.02	<2.17	1,460	4,960	
20-Sep-10	21.3	<10.0	1,490	4,840	
29-Jun-10	1.5	<1.0	1,400	4,630	
24-Mar-10	6.1	ND	1,530	4,400	
14-Dec-09	14.1	ND	1,550	4,560	
1-Sep-09	18.9	ND	1,630	4,734	
2-Jun-09	2.9	ND	1,590	1,782	
3-Mar-09	2.65	ND	1,510	4,664	

**TABLE 5. DISCHARGE PLAN MONITORING WELL GROUNDWATER ANALYTICAL RESULTS
DONA ANA DAIRIES, DONA ANA COUNTY, NEW MEXICO**

Monitoring Well	Date Sampled	Nitrate as N (mg/l)	TKN (mg/l)	Chloride (mg/l)	TDS (mg/l)
74-04	15-May-23	12	<2.0	460	1,830
	21-Feb-23	13	<2.0	670	2,280
	15-Nov-22	16	<2.0	580	2,170
	16-Aug-22	12	<2.0	630	2,150
	16-May-22	11	<2.0	590	2,080
	23-Feb-22	12	<2.0	730	2,300
	12-Nov-21	12	<2.0	620	2,280
	7-Sep-21	<0.50	<1.0	610	2,030
	17-May-21	8.1	<1.0	580	2,160
	22-Feb-21	11	<1.0	690	2,140
	17-Nov-20	<0.50	2.2	530	3,840
	21-Aug-20	11	<2.0	640	2,200
	18-May-20	10	<2.0	470	1,670
	14-Feb-20	12	<2.0	600	2,120
	20-Nov-19	12	<2.0	630	2,180
	14-Aug-19	11	<2.0	640	2,250
	21-May-19	15	<2.0	490	1,890
	1-Mar-19	12	<2.0	600	2,140
	16-Nov-18	12	<2.0	620	2,140
	31-Aug-18	12	<2.0	590	2,140
	23-May-18	12	<2.0	580	2,060
	19-Feb-18	9.2	<1.0	500	1,960
	14-Nov-17	10.6	<0.0500	532	1,840
	16-Aug-17	11.6	<0.0500	569	2,020
	26-May-17	18.6	<0.0501	516	1,910
	24-Feb-17	11.5	<0.300	555	1,920
	15-Nov-16	11.3	1.14	551	2,070
	25-Aug-16	13.1	<0.937	596	2,060
	25-May-16	20.0	<2.24	530	2,060
	18-Feb-16	12.9	<1.18	582	2,010
	12-Nov-15	13.5	2.24	584	2,040
	24-Aug-15	21.7	<1.18	576	2,120
	20-May-15	22.4	<1.18	524	1,900
	16-Feb-15	13.4	2.10	491	1,520
	20-Nov-14	14.7	<1.80	538	2,140
	21-Aug-14	16.3	<1.80	556	2,060
	21-May-14	20.1	<1.80	537	1,880
	3-Mar-14	18.1	<1.66	565	2,080
	19-Nov-13	17.3	2.10	570	1,910
	22-Aug-13	16.4	3.50	560	2,160
16-May-13	17.6	<1.66	502	1,890	
20-Feb-13	18.5	<1.72	499	1,960	
14-Nov-12	19.3	<1.72	499	2,140	
10-Aug-12	18.8	<1.72	477	1,920	
3-May-12	33.6	<1.72	436	1,800	
8-Feb-12	31.6	<2.17	473	2,020	
3-Nov-11	13.4	<2.17	439	1,080	
29-Jul-11	15.3	<2.17	438	1,580	
26-Apr-11	12.8	<2.17	451	1,820	
25-Jan-11	6.50	<2.17	434	1,810	
20-Sep-10	10.6	<10.0	441	1,640	
29-Jun-10	15	<1.0	500	1,840	
24-Mar-10	11.4	0.28	570	1,792	
14-Dec-09	11.5	ND	560	1,738	
1-Sep-09	19.3	ND	550	1,792	
2-Jun-09	7.2	ND	570	2,024	
3-Mar-09	20.3	ND	530	1,884	

**TABLE 5. DISCHARGE PLAN MONITORING WELL GROUNDWATER ANALYTICAL RESULTS
DONA ANA DAIRIES, DONA ANA COUNTY, NEW MEXICO**

Monitoring Well	Date Sampled	Nitrate as N (mg/l)	TKN (mg/l)	Chloride (mg/l)	TDS (mg/l)
74-05	15-May-23	20	<5.0	600	2,170
	21-Feb-23	15	<2.0	630	2,240
	15-Nov-22	15	<2.0	580	2,230
	16-Aug-22	16	<2.0	660	2,270
	16-May-22	15	<2.0	680	2,210
	23-Feb-22	13	<2.0	660	2,190
	15-Nov-21	13	<2.0	<0.50	2,200
	31-Aug-21	14	<2.0	670	2,160
	17-May-21	11	<2.0	790	2,280
	23-Feb-21	6.3	2.2	690	2,210
	17-Nov-20	<0.50	4.2	610	3,320
	21-Aug-20	14	<2.0	630	2,170
	18-May-20	15	<2.0	650	2,160
	14-Feb-20	14	<2.0	600	2,050
	20-Nov-19	14	<2.0	540	2,080
	13-Aug-19	14	<2.0	580	2,100
	21-May-19	15	<2.0	580	2,160
	1-Mar-19	15	<2.0	590	2,140
	16-Nov-18	14	<2.0	560	2,070
	29-Aug-18	14	<2.0	560	2,890
	23-May-18	14	<2.0	580	2,110
	19-Feb-18	14	<2.0	570	2,100
	14-Nov-17	12.0	<0.0500	539	1,860
	16-Aug-17	12.7	<0.0500	561	1,950
	26-May-17	13.4	<0.0501	590	2,140
	24-Feb-17	12.8	<0.300	568	2,080
	15-Nov-16	12.0	<0.937	560	2,020
	25-Aug-16	14.7	<0.937	455	2,040
	25-May-16	15.6	<2.24	533	2,010
	18-Feb-16	15.3	2.24	569	2,040
	12-Nov-15	15.4	<1.18	561	2,020
	24-Aug-15	22.7	<1.18	505	2,040
	20-May-15	20.0	<1.18	495	1,960
	16-Feb-15	16.9	<1.80	504	1,840
	20-Nov-14	17.3	<1.80	493	1,890
	21-Aug-14	18.8	<1.8	464	1,880
	21-May-14	19.8	<1.80	452	1,860
	25-Feb-14	18.3	<1.66	506	1,960
	19-Nov-13	18.4	<1.66	493	1,840
	22-Aug-13	18.8	4.2	497	1,980
	16-May-13	17.5	<1.66	469	1,860
	20-Feb-13	17.8	<1.72	470	1,870
	14-Nov-12	17.0	<1.72	219	1,900
	10-Aug-12	18.0	<1.72	463	1,800
	3-May-12	18.0	<1.72	421	1,900
	8-Feb-12	17.4	<2.17	442	1,960
	3-Nov-11	17.9	<2.17	442	960
	29-Jul-11	23.3	<2.17	449	2,000
	26-Apr-11	21.5	<2.17	446	1,900
	25-Jan-11	16.5	<2.17	446	1,940
17-Sep-10	17.6	<10.0	439	1,880	
29-Jun-10	32	<1.0	520	2,070	
24-Mar-10	23.2	ND	620	1,960	
14-Dec-09	15.9	ND	600	1,924	
1-Sep-09	25.2	ND	540	1,964	
2-Jun-09	10.8	ND	560	2,068	
3-Mar-09	33.2	ND	535	2,038	

**TABLE 5. DISCHARGE PLAN MONITORING WELL GROUNDWATER ANALYTICAL RESULTS
DONA ANA DAIRIES, DONA ANA COUNTY, NEW MEXICO**

Monitoring Well	Date Sampled	Nitrate as N (mg/l)	TKN (mg/l)	Chloride (mg/l)	TDS (mg/l)
River Valley Dairy					
167-01	13-Aug-14	Not Sampled			
	23-May-14	Not Sampled			
	28-Feb-14	Not Sampled			
	10-Dec-13	Not Sampled			
	27-Aug-13	<0.164	10.5	290	1,260
	17-May-13	Not Sampled			
	20-Feb-13	Not Sampled			
	15-Nov-12	Not Sampled			
	14-Aug-12	Not Sampled			
	2-May-12	Not Sampled			
	30-Jan-12	Not Sampled			
	2-Nov-11	Not Sampled			
	25-Jul-11	Not Sampled			
	28-Apr-11	<0.500	3.92	720	2,960
	20-Jan-11	Not Sampled			
	27-Sep-10	1.55	9.94	731	2,540
	28-Jun-10	Not Sampled			
5-Mar-10					
15-Jan-10					
14-Sep-09					
2-Jun-09					
15-Mar-09	Not Sampled				
167-01A	15-Nov-17	0.213	0.379	325	1,930
	16-Aug-17	0.510	<0.300	493	2,540
	23-May-17	0.223	0.680	519	2,540
	27-Feb-17	0.168	0.974	553	2,660
	15-Nov-16	1.18	<0.937	540	2,600
	30-Aug-16	0.386	<0.937	596	5,980
	24-May-16	0.933	<2.24	587	2,900
	17-Feb-16	<0.194	<1.18	703	2,960
	16-Nov-15	<0.194	<1.18	669	2,920
	24-Aug-15	0.216	<1.18	698	2,980
	20-May-15	1.18	<1.18	693	3,020
	16-Feb-15	1.18	<1.80	669	3,070
	20-Nov-14	1.65	19.6	539	3,260
	4-Sep-14	2.52	<1.80	652	3,070
	23-May-14	1.59	2.80	666	2,860
	28-Feb-14	2.03	<1.66	656	2,820
	10-Dec-13	2.35	2.80	643	2,720
	26-Aug-13	4.84	10.5	907	3,610
	17-May-13	4.83	<1.66	794	3,420
	20-Feb-13	1.10	<1.72	845	3,360
	15-Nov-12	4.02	<1.72	778	3,440
	14-Aug-12	1.78	4.20	888	3,260
	2-May-12	2.55	1.82	781	3,180
	30-Jan-12	2.54	3.50	755	2,940
	2-Nov-11	11.2	4.62	1,080	3,620
	25-Jul-11	2.13	3.92	943	3,330
	28-Apr-11	4.03	<2.17	1,030	3,710
	20-Jan-11	1.26	2.1	968	5,100
	22-Sep-10	1.40	3.36	1,010	3,470
	28-Jun-10	6.07	1.1	1,050	3,710
5-Mar-10	9.3	0.8	1,040	3,605	
15-Jan-10	5.3	0.5	1,090	3,590	
14-Sep-09	13.4	0.6	1,040	3,530	
2-Jun-09	13.7	0.7	980	3,505	
15-Mar-09	22.2	0.2	740	3,130	

**TABLE 5. DISCHARGE PLAN MONITORING WELL GROUNDWATER ANALYTICAL RESULTS
DONA ANA DAIRIES, DONA ANA COUNTY, NEW MEXICO**

Monitoring Well	Date Sampled	Nitrate as N (mg/l)	TKN (mg/l)	Chloride (mg/l)	TDS (mg/l)	
167-02	15-Nov-17	7.86	<0.300	818	2,460	
	16-Aug-17	7.76	<0.300	800	2,400	
	23-May-17	4.69	<0.0501	707	2,220	
	27-Feb-17	3.63	<0.300	701	2,280	
	15-Nov-16	2.32	<0.937	539	1,990	
	30-Aug-16	<0.305	<0.937	540	1,690	
	24-May-16	0.370	<2.24	521	1,680	
	17-Feb-16	<0.194	<1.18	486	1,560	
	16-Nov-15	Dry				
	24-Aug-15	Dry				
	20-May-15	Dry				
	16-Feb-15	0.878	<1.80	435	1,360	
	20-Nov-14	Dry				
	4-Sep-14	0.928	<1.80	455	1,580	
	18-Jun-14	Dry				
	28-Feb-14	Dry				
	10-Dec-13	Dry				
	23-Aug-13	Dry				
	17-May-13	Not Sampled				
	20-Feb-13	Not Sampled				
	15-Nov-12	Not Sampled				
	14-Aug-12	Not Sampled				
	30-Jan-12	Not Sampled				
	2-Nov-11	<0.500	3.64	432	650	
	25-Jul-11	Dry				
	28-Apr-11	<0.500	2.94	500	1,910	
	20-Jan-11	0.716	< 2.05	546	1,840	
	22-Sep-10	<0.846	<10.0	610	2,100	
	28-Jun-10	Not Sampled				
	5-Mar-10					
	15-Jan-10					
	14-Sep-09					
2-Jun-09						
28-Apr-08	7.0	0.3	780	2,580		

**TABLE 5. DISCHARGE PLAN MONITORING WELL GROUNDWATER ANALYTICAL RESULTS
DONA ANA DAIRIES, DONA ANA COUNTY, NEW MEXICO**

Monitoring Well	Date Sampled	Nitrate as N (mg/l)	TKN (mg/l)	Chloride (mg/l)	TDS (mg/l)
167-03	15-Nov-17	9.61	<0.300	445	1,680
	17-Aug-17	10.4	<0.300	456	1,830
	25-May-17	9.52	<0.300	431	1,820
	27-Feb-17	8.12	<0.300	428	1,880
	15-Nov-16	8.38	6.25	429	1,790
	31-Aug-16	9.94	<0.937	465	1,840
	25-May-16	10.8	<2.24	442	1,940
	17-Feb-16	10.5	<1.18	470	1,830
	16-Nov-15	12.7	1.68	497	2,000
	25-Aug-15	13.3	<1.18	496	2,020
	20-May-15	12.6	<1.18	478	1,940
	18-Feb-15	10.3	<1.80	429	1,940
	24-Nov-14	16.2	<1.80	529	2,080
	4-Sep-14	17.1	<1.80	534	2,220
	23-May-14	16.6	2.80	440	2,200
	28-Feb-14	15.4	<1.66	516	2,140
	10-Dec-13	17.6	<1.66	578	2,310
	26-Aug-13	19.0	2.80	587	2,440
	20-May-13	16.7	<1.66	543	2,140
	21-Feb-13	13.0	<1.72	500	1,950
	15-Nov-12	15.0	<1.72	503	2,150
	14-Aug-12	16.6	<1.72	500	2,350
	2-May-12	17.5	<1.72	499	2,220
	27-Jan-12	21.0	<2.17	572	2,250
	2-Nov-11	22.0	<2.17	564	2,150
	25-Jul-11	18.5	6.16	543	2,250
	28-Apr-11	17.1	<2.17	508	2,210
	20-Jan-11	13.2	2.24	467	1,880
	22-Sep-10	9.19	<10.0	472	2,120
	28-Jun-10	20.4	<5.0	567	2,310
5-Mar-10	18.4	<0.3	610	2,265	
15-Jan-10	13.7	0.6	620	2,015	
14-Sep-09	23.1	0.4	590	2,240	
2-Jun-09	25.0	0.5	680	2,515	
15-Mar-09	30.9	0.2	760	2,615	

**TABLE 5. DISCHARGE PLAN MONITORING WELL GROUNDWATER ANALYTICAL RESULTS
DONA ANA DAIRIES, DONA ANA COUNTY, NEW MEXICO**

Monitoring Well	Date Sampled	Nitrate as N (mg/l)	TKN (mg/l)	Chloride (mg/l)	TDS (mg/l)	
167-04	15-Nov-17	23.7	<0.300	982	3,280	
	17-Aug-17	26.3	<0.300	1,010	3,640	
	25-May-17	23.2	<0.300	956	3,490	
	27-Feb-17	24.0	<0.300	973	3,620	
	15-Nov-16	24.4	6.25	811	3,540	
	30-Aug-16	25.0	<0.937	1,020	3,560	
	24-May-16	25.9	<2.24	949	3,760	
	17-Feb-16	27.4	<1.18	998	3,740	
	16-Nov-15	27.2	1.68	952	3,410	
	25-Aug-15	27.0	<1.18	1,040	3,860	
	21-May-15	25.4	<1.18	1,050	3,740	
	18-Feb-15	27.7	<1.80	823	3,450	
	24-Nov-14	29.0	<1.80	908	3,520	
	4-Sep-14	25.1	<1.80	1,040	4,210	
	22-May-14	26.5	18.2	1,010	3,600	
	3-Mar-14	25.1	2.10	1,180	4,080	
	10-Dec-13	23.8	2.10	1,190	4,070	
	26-Aug-13	25.5	6.30	1,090	3,900	
	17-May-13	4.40	<1.66	796	4,170	
	20-Feb-13	21.9	<1.72	1,320	4,660	
	15-Nov-12	7.77	<1.72	1,150	4,380	
	14-Aug-12	23.2	2.10	1,110	4,540	
	2-May-12	18.6	13.6	1,050	4,020	
	27-Jan-12	15.6	3.50	1,500	4,840	
	2-Nov-11	Not Sampled - insufficient water to sample				
	26-Jul-11	19.3	4.62	1,270	4,560	
	28-Apr-11	7.95	73.1	1,610	4,960	
	20-Jan-11	Not Sampled				
	28-Jun-10					
	5-Mar-10					
	15-Jan-10					
	14-Sep-09	6.7	0.4	1,630	5,240	
	2-Jun-09	8.5	0.4	1,525	5,045	
	15-Mar-09	16.4	0.2	1,570	5,210	
167-05	15-Nov-17	2.56	0.573	852	3,190	
	17-Aug-17	3.61	<0.300	831	3,390	
	25-May-17	3.93	1.01	767	3,100	
	28-Feb-17	3.35	2.88	785	3,220	
	16-Nov-16	3.57	1.70	765	3,340	
	30-Aug-16	2.94	<0.937	806	3,400	
	24-May-16	5.43	<2.24	741	3,220	
	17-Feb-16	4.42	<1.18	732	2,960	
	13-Nov-15	4.28	4.48	763	3,140	
	25-Aug-15	3.40	2.10	756	3,100	
	21-May-15	6.62	1.40	688	2,880	
	19-Feb-15	4.97	<1.80	671	3,080	
	20-Nov-14	2.62	<1.80	747	3,360	
	3-Sep-14	4.16	<1.80	709	3,240	
	23-May-14	3.62	3.50	764	3,010	
	3-Mar-14	2.25	<1.66	818	3,180	
	10-Dec-13	1.58	3.50	886	3,290	
	26-Aug-13	4.54	3.50	767	3,400	
	17-May-13	23.3	<1.66	1,120	3,140	
	21-Feb-13	3.73	<1.72	842	3,360	
	19-Nov-12	2.31	<1.72	805	3,480	
	14-Aug-12	1.48	<1.72	1,630	3,220	
	2-May-12	3.50	2.24	777	3,180	
	30-Jan-12	4.40	<2.17	808	3,140	
	2-Nov-11	3.89	3.64	782	2,560	
	26-Jul-11	4.41	3.22	792	3,070	
	28-Apr-11	12.9	2.80	976	3,630	
	20-Jan-11	3.53	2.52	748	2,980	
	23-Sep-10	2.70	<10.0	758	2,820	
	28-Jun-10	4.07	<1.0	789	2,930	
	5-Mar-10	2.9	<0.3	960	2,945	
15-Jan-10	1.8	<0.3	380	715		
14-Sep-09	1.9	0.4	890	2,970		
2-Jun-09	1.8	0.9	850	3,005		
15-Mar-09	4.6	0.2	910	3,230		

**TABLE 5. DISCHARGE PLAN MONITORING WELL GROUNDWATER ANALYTICAL RESULTS
DONA ANA DAIRIES, DONA ANA COUNTY, NEW MEXICO**

Monitoring Well	Date Sampled	Nitrate as N (mg/l)	TKN (mg/l)	Chloride (mg/l)	TDS (mg/l)
167-06	15-Nov-17	15.0	<0.300	565	2,230
	17-Aug-17	15.9	<0.300	589	2,220
	25-May-17	16.9	<0.300	570	2,330
	27-Feb-17	16.3	<0.300	571	2,330
	15-Nov-16	15.3	<0.937	354	2,310
	30-Aug-16	17.0	<0.937	608	2,380
	24-May-16	17.4	<2.24	607	2,440
	17-Feb-16	18.8	<1.18	633	2,400
	13-Nov-15	19.5	<1.18	650	2,550
	24-Aug-15	20.2	<1.18	642	2,620
	20-May-15	19.7	<1.18	649	2,490
	16-Feb-15	19.1	<1.80	591	2,580
	20-Nov-14	21.1	<1.80	702	2,900
	4-Sep-14	22.8	4.20	689	2,820
	22-May-14	22.8	4.20	726	2,660
	28-Feb-14	22.1	<1.66	707	2,620
	10-Dec-13	20.8	6.30	744	2,740
	26-Aug-13	29.0	2.10	757	2,740
	20-May-13	23.9	<1.66	704	2,620
	20-Feb-13	22.8	<1.72	725	2,660
	19-Nov-12	23.7	<1.72	718	2,980
	14-Aug-12	25.1	<1.72	677	2,910
	2-May-12	27.2	<1.72	688	2,480
	30-Jan-12	29.1	<2.17	754	2,880
	2-Nov-11	35.7	<2.17	716	3,390
	25-Jul-11	35.0	5.32	702	2,640
	28-Apr-11	35.4	<2.17	676	2,790
	20-Jan-11	29.6	2.38	634	2,560
	22-Sep-10	19.8	<10.0	655	2,630
	28-Jun-10	34.8	2.35	687	2,700
	5-Mar-10	30.9	<0.3	730	2,730
	15-Jan-10	26.2	0.4	750	2,755
14-Sep-09	40.4	<0.3	700	2,680	
2-Jun-09	31.5	0.4	790	2,715	
15-Mar-09	36.2	0.7	730	2,715	
167-07	15-Nov-17	0.114	<0.300	130	1,340
	17-Aug-17	0.119	<0.300	143	1,460
	23-May-17	0.120	<0.0501	140	1,210
	27-Feb-17	0.107	1.07	118	1,050
	15-Nov-16	1.26	<0.937	107	1,080
	30-Aug-16	<0.305	<0.937	123	1,370
	24-May-16	0.131	<2.24	93.6	1,460
	17-Feb-16	<0.0387	2.80	128	1,480
	13-Nov-15	<0.0387	<1.18	124	1,350
	24-Aug-15	<0.194	<1.18	542	4,990
	20-May-15	<0.0470	<1.18	206	1,540
	19-Feb-15	<0.0137	<1.80	196	1,600
	20-Nov-14	<0.126	<1.80	258	2,300
	4-Sep-14	<0.126	<1.80	609	5,680
	23-May-14	<0.187	<1.80	209	1,490
	28-Feb-14	<0.213	2.10	229	1,540
	10-Dec-13	0.960	6.30	233	1,770
	26-Aug-13	2.00	4.20	681	4,770
	17-May-13	<0.0420	<1.66	319	1,840
	20-Feb-13	<0.246	<1.72	446	3,640
	15-Nov-12	<0.0595	<1.72	498	3,280
	14-Aug-12	<0.114	4.06	1,160	6,090
	2-May-12	0.0285	<1.72	367	1,890
	30-Jan-12	<0.500	<2.17	411	1,850
	2-Nov-11	<0.500	<2.17	366	2,460
	25-Jul-11	<1.00	3.50	446	4,400
	28-Apr-11	<0.500	<2.17	292	1,750
	20-Jan-11	0.448	2.10	239	1,280
	22-Sep-10	0.0400	2.10	268	1,590
	28-Jun-10	<0.5	<2.0	287	1,600
	5-Mar-10	0.16	<0.3	370	1,650
	15-Jan-10	<0.03	<0.3	250	2,065
14-Sep-09	0.19	<0.3	390	1,700	
2-Jun-09	0.11	0.4	740	2,575	
15-Mar-09	0.11	0.2	1,090	3,165	

**TABLE 5. DISCHARGE PLAN MONITORING WELL GROUNDWATER ANALYTICAL RESULTS
DONA ANA DAIRIES, DONA ANA COUNTY, NEW MEXICO**

Monitoring Well	Date Sampled	Nitrate as N (mg/l)	TKN (mg/l)	Chloride (mg/l)	TDS (mg/l)	
167-08	15-Nov-17	0.478	0.591	1,190	6,860	
	17-Aug-17	1.28	<0.300	1,190	3,650	
	25-May-17	0.277	0.587	1,070	3,570	
	28-Feb-17	1.06	1.14	1,100	3,670	
	16-Nov-16	0.903	<0.937	1,010	3,530	
	31-Aug-16	<0.305	<0.937	1,000	3,300	
	25-May-16	<0.305	<2.24	761	3,000	
	17-Feb-16	<0.194	<1.18	1,050	3,480	
	23-Nov-15	<0.194	<1.18	699	2,460	
	25-Aug-15	Bailer Down Well -Not Sampled				
	21-May-15	<0.0470	<1.18	733	2,680	
	24-Feb-15	<0.0137	2.10	729	2,960	
	24-Nov-14	<0.126	<1.80	944	3,020	
	4-Sep-14	<0.126	<1.80	726	2,840	
	27-May-14	<0.187	2.10	777	2,920	
	4-Mar-14	1.02	<1.66	884	3,090	
	10-Dec-13	Not Sampled				
	27-Aug-13	Not Sampled				
	21-May-13	1.13	<1.66	723	2,820	
	25-Feb-13	0.895	<1.72	827	2,640	
	15-Nov-12	Well Damaged - Not Sampled				
	14-Aug-12	0.192	<1.72	788	2,860	
	2-May-12	0.399	<1.72	744	2,580	
	30-Jan-12	<0.500	<2.17	805	2,440	
	2-Nov-11	1.93	<2.17	759	2,520	
	26-Jul-11	3.77	4.20	779	3,030	
	28-Apr-11	3.74	<2.17	793	2,740	
	20-Jan-11	<0.239	2.10	764	2,640	
	23-Sep-10	0.250	<10.0	756	2,720	
	28-Jun-10	5.51	<0.5	804	2,990	
	5-Mar-10	5.5	<0.3	830	2,750	
	15-Jan-10	0.84	<0.3	720	2,530	
	14-Sep-09	2.9	0.3	640	2,380	
	2-Jun-09	2.1	0.6	750	2,785	
	15-Mar-09	3.2	0.2	740	2,710	
	167-09	15-Nov-17	0.289	0.631	1,050	2,510
		17-Aug-17	0.561	<0.300	874	2,940
		25-May-17	0.819	<0.300	748	2,830
		27-Feb-17	0.722	1.00	631	2,540
		15-Nov-16	0.991	<0.937	491	2,620
30-Aug-16		<0.305	<0.937	670	2,680	
24-May-16		1.54	<2.24	631	2,570	
17-Feb-16		<0.194	<1.18	576	2,500	
13-Nov-15		<0.194	<1.18	627	2,400	
25-Aug-15		2.30	1.40	563	2,480	
21-May-15		4.15	<1.18	602	2,440	
19-Feb-15		5.42	<1.80	719	2,710	
20-Nov-14		6.31	2.80	683	2,830	
3-Sep-14		10.5	<1.80	680	2,980	
23-May-14		10.1	3.50	721	2,800	
3-Mar-14		6.49	<1.66	756	2,840	
10-Dec-13		3.82	4.90	777	2,980	
27-Aug-13		6.24	5.60	772	3,320	
17-May-13		10.7	<1.66	726	3,050	
21-Feb-13		4.51	<1.72	959	3,580	
19-Nov-12		12.8	<1.72	979	3,560	
14-Aug-12		8.47	2.10	916	3,760	
2-May-12		14.5	<1.72	1,070	4,000	
30-Jan-12		13.2	2.80	1,010	3,590	
3-Nov-11		7.53	8.40	988	3,590	
26-Jul-11		<1.00	3.78	736	2,300	
28-Apr-11		<0.500	2.38	467	2,140	
20-Jan-11		0.0147	<2.05	429	2,160	
24-Sep-10		0.0300	<10.0	432	1,500	
28-Jun-10		<0.5	<1.0	491	2,160	
5-Mar-10		0.05	<0.3	580	2,150	
15-Jan-10		<0.03	<0.3	500	2,250	
14-Sep-09		<0.03	<0.3	530	2,055	
2-Jun-09		0.04	0.7	540	2,205	
15-Mar-09		0.07	0.2	630	2,400	

**TABLE 5. DISCHARGE PLAN MONITORING WELL GROUNDWATER ANALYTICAL RESULTS
DONA ANA DAIRIES, DONA ANA COUNTY, NEW MEXICO**

Monitoring Well	Date Sampled	Nitrate as N (mg/l)	TKN (mg/l)	Chloride (mg/l)	TDS (mg/l)	
Big Sky Dairy						
833-01	5-Aug-17	Plugged and Abandoned				
	31-May-17	Dry				
	1-Mar-17	Dry				
	17-Nov-16	Dry				
	29-Aug-16	Dry				
	27-May-16	Dry				
	22-Feb-16	Dry				
	18-Nov-15	Dry				
	27-Aug-15	Dry				
	21-May-15	Dry				
	25-Feb-15	Dry				
	25-Nov-14	Dry				
	25-Aug-14	Dry				
	27-May-14	Dry				
	4-Mar-14	Dry				
	6-Nov-13	Dry				
	29-Aug-13	Dry				
	21-May-13	Dry				
	26-Feb-13	Dry				
	19-Nov-12	Dry				
	15-Aug-12	Dry				
	7-May-12	Dry				
	15-Feb-12	Dry				
	1-Nov-11	Dry				
	21-Jul-11	Dry				
	29-Apr-11	Not Sampled - insufficient water to sample				
	24-Jan-11	33.6	4.20	997	3,100	
	23-Sep-10	29.1	<10.0	881	3,300	
	28-Jun-10	1.7	1.8	180	790	
	23-Mar-10	28.3	0.7	1,025	2,640	
14-Dec-09	21.8	ND	975	2,800		
31-Aug-09	15.3	ND	999	2,894		
1-Jun-09	8.6	ND	1,030	2,382		
2-Mar-09	37.1	ND	1,070	3,750		

**TABLE 5. DISCHARGE PLAN MONITORING WELL GROUNDWATER ANALYTICAL RESULTS
DONA ANA DAIRIES, DONA ANA COUNTY, NEW MEXICO**

Monitoring Well	Date Sampled	Nitrate as N (mg/l)	TKN (mg/l)	Chloride (mg/l)	TDS (mg/l)
833-02	16-May-23	37	<5.0	1,300	3,760
	22-Feb-23	33	<5.0	1,400	3,690
	17-Nov-22	72	<5.0	930	3,280
	17-Aug-22	89	<5.0	810	3,030
	18-May-22	36	<5.0	1,400	4,030
	24-Feb-22	53	<5.0	1,200	3,580
	16-Nov-21	41	<5.0	1,300	3,920
	17-Aug-21	80	<5.0	1,300	4,100
	18-May-21	67	<5.0	1,400	4,280
	24-Feb-21	59	<5.0	1,300	3,920
	18-Nov-20	89	<5.0	1,100	3,960
	24-Aug-20	88	<5.0	1,000	3,300
	20-May-20	81	<5.0	950	3,180
	17-Feb-20	63	<5.0	1,200	3,790
	21-Nov-19	100	<5.0	1,000	3,520
	14-Aug-19	65	<5.0	1,400	4,240
	22-May-19	68	<5.0	1,400	4,230
	4-Mar-19	66	<5.0	1,300	4,180
	26-Nov-18	62	<5.0	1,300	4,240
	31-Aug-18	67	<5.0	1,300	4,190
	29-May-18	63	<5.0	1,300	4,210
	21-Feb-18	65	<5.0	1,200	4,240
	16-Nov-17	66.4	<0.0500	1,300	3,730
	1-Sep-17	90.2	<0.0500	977	3,140
	30-May-17	71.2	<0.0501	1,340	4,380
	28-Feb-17	62.3	<0.300	1,240	4,290
	18-Nov-16	68.5	<0.937	1,340	4,210
	29-Aug-16	69.5	<0.937	1,360	4,360
	31-May-16	79.9	<2.24	1,400	4,440
	22-Feb-16	48.0	<1.18	796	2,400
	18-Nov-15	74.5	4.48	1,300	4,240
	27-Aug-15	44.5	2.80	720	2,250
	22-May-15	34.5	<1.18	702	2,140
	25-Feb-15	50.9	<1.80	780	2,820
	25-Nov-14	60.4	<1.80	1,010	3,480
	25-Aug-14	24.8	<1.80	528	2,090
	27-May-14	27.0	2.10	563	2,140
	5-Mar-14	79.8	<1.66	1,120	3,920
	20-Nov-13	65.4	2.10	884	3,060
	5-Sep-13	85.8	69.3	1,080	4,270
21-May-13	69.2	<1.66	858	3,140	
25-Feb-13	97.0	<1.72	1,110	3,820	
19-Nov-12	84.3	2.10	1,030	4,020	
15-Aug-12	37.5	2.94	535	2,440	
7-May-12	43.3	65.1	635	2,420	
15-Feb-12	87.2	4.34	889	3,660	
1-Nov-11	82.3	2.38	885	4,010	
21-Jul-11	91.6	3.08	880	3,510	
29-Apr-11	81.6	6.02	840	3,500	
24-Jan-11	69.3	2.66	789	3,090	
23-Sep-10	52.9	<10.0	833	3,650	
28-Jun-10	29	<5.0	560	2,200	
23-Mar-10	15.9	ND	660	2,066	
14-Dec-09	11.5	0.28	650	2,018	
31-Aug-09	12.4	ND	660	2,170	
1-Jun-09	<0.5	ND	650	3,358	
2-Mar-09	3.54	13.44	585	1,978	

**TABLE 5. DISCHARGE PLAN MONITORING WELL GROUNDWATER ANALYTICAL RESULTS
DONA ANA DAIRIES, DONA ANA COUNTY, NEW MEXICO**

Monitoring Well	Date Sampled	Nitrate as N (mg/l)	TKN (mg/l)	Chloride (mg/l)	TDS (mg/l)
833-03	5-Aug-17	Plugged and Abandoned			
	30-May-17	Dry			
	1-Mar-17	Dry			
	17-Nov-16	Dry			
	29-Aug-16	Dry			
	27-May-16	Dry			
	22-Feb-16	Dry			
	18-Nov-15	Dry			
	27-Aug-15	Dry			
	21-May-15	Dry			
	25-Feb-15	Dry			
	24-Nov-14	Dry			
	25-Aug-14	Dry			
	27-May-14	Dry			
	3-Mar-14	Dry			
	6-Nov-13	Dry			
	29-Aug-13	Dry			
	21-May-13	Dry			
	25-Feb-13	Dry			
	19-Nov-12	Dry			
	15-Aug-12	Dry			
	3-May-12	Dry			
	15-Feb-12	Dry			
	1-Nov-11	Dry			
	21-Jul-11	Dry			
	4-May-11	24.8	4.20	1,660	4,120
	24-Jan-11	30.4	2.66	1,650	4,090
	23-Sep-10	18.1	<10.0	1,410	3,880
	28-Jun-10	5.0	5.5	650	1,870
	23-Mar-10	14.0	ND	1,750	4,044
14-Dec-09	11.8	0.28	1,839	4,280	
31-Aug-09	8.9	ND	1,760	4,216	
1-Jun-09	90.4	ND	1,620	3,060	
2-Mar-09	21.2	ND	1,580	3,970	

**TABLE 5. DISCHARGE PLAN MONITORING WELL GROUNDWATER ANALYTICAL RESULTS
DONA ANA DAIRIES, DONA ANA COUNTY, NEW MEXICO**

Monitoring Well	Date Sampled	Nitrate as N (mg/l)	TKN (mg/l)	Chloride (mg/l)	TDS (mg/l)
833-04	16-May-23	29	<5.0	790	2,650
	21-Feb-23	37	<5.0	900	2,960
	17-Nov-22	35	<5.0	820	2,870
	17-Aug-22	21	<5.0	650	2,390
	16-May-22	36	<5.0	950	3,000
	24-Feb-22	29	<5.0	890	2,860
	15-Nov-21	24	<5.0	940	2,830
	17-Aug-21	32	<5.0	830	2,770
	17-May-21	20	<5.0	680	2,410
	23-Feb-21	21	<5.0	740	2,350
	18-Nov-20	22	<5.0	620	2,510
	24-Aug-20	18	<2.0	690	2,240
	20-May-20	18	<2.0	670	2,290
	17-Feb-20	20	<5.0	720	2,450
	20-Nov-19	31	<5.0	840	2,800
	15-Aug-19	40	<1.0	980	3,170
	23-May-19	29	<5.0	800	2,800
	4-Mar-19	31	<5.0	830	2,900
	26-Nov-18	42	<5.0	950	3,230
	4-Sep-18	40	<5.0	960	3,190
	24-May-18	34	<5.0	910	3,010
	20-Feb-18	20	<5.0	680	2,390
	20-Nov-17	32.6	<0.300	902	2,930
	31-Aug-17	37.3	<0.0500	797	2,640
	30-May-17	32.0	<0.0501	880	3,000
	1-Mar-17	31.5	<0.300	866	3,080
	18-Nov-16	39.8	<0.937	586	3,300
	29-Aug-16	40.6	<0.937	977	3,160
	27-May-16	21.6	<2.24	781	2,660
	22-Feb-16	12.7	<1.18	746	2,130
	19-Nov-15	11.8	3.36	762	2,310
	27-Aug-15	26.2	<1.18	835	2,580
	22-May-15	15.6	<1.18	766	2,290
	25-Feb-15	15.5	<1.80	666	2,260
	25-Nov-14	46.6	<1.80	914	3,280
	22-Aug-14	10.4	<1.80	677	2,230
	29-May-14	23.5	5.60	780	2,670
	4-Mar-14	50.0	<1.66	1,010	3,530
	20-Nov-13	12.8	2.10	711	2,280
	30-Aug-13	37.9	2.80	868	3,260
21-May-13	41.9	<1.66	875	3,180	
25-Feb-13	2.45	<1.72	1,050	3,600	
19-Nov-12	50.0	<1.72	1,010	3,770	
15-Aug-12	32.7	2.66	783	2,680	
3-May-12	24.1	<1.72	623	2,920	
15-Feb-12	49.9	<2.17	942	3,320	
1-Nov-11	43.4	<2.17	867	3,040	
21-Jul-11	45.3	2.52	883	3,410	
29-Apr-11	46.2	<2.17	902	3,280	
24-Jan-11	40.9	<2.05	755	3,040	
24-Sep-10	<50.0	<10.0	915	3,480	
28-Jun-10	18	<2.0	500	1,830	
23-Mar-10	11.3	ND	560	1,648	
14-Dec-09	11.2	0.42	570	1,750	
31-Aug-09	16.1	ND	630	1,986	
1-Jun-09	3.03	ND	580	1,968	
2-Mar-09	14.6	ND	600	1,884	

**TABLE 5. DISCHARGE PLAN MONITORING WELL GROUNDWATER ANALYTICAL RESULTS
DONA ANA DAIRIES, DONA ANA COUNTY, NEW MEXICO**

Monitoring Well	Date Sampled	Nitrate as N (mg/l)	TKN (mg/l)	Chloride (mg/l)	TDS (mg/l)
833-05	3-Jul-23	24	<5.0	1,000	3,120
	23-Feb-23	30	<5.0	1,300	3,300
	21-Nov-22	28	<5.0	1,100	3,190
	18-Aug-22	26	<5.0	1,200	3,560
	18-May-22	32	<5.0	1,200	3,500
	10-Mar-22	45	<5.0	1,200	3,490
	16-Nov-21	41	<5.0	1,200	3,510
	17-Aug-21	34	<2.0	1,300	3,490
	19-May-21	32	<5.0	1,100	3,460
	25-Feb-21	45	<5.0	1,300	3,460
	19-Nov-20	46	<5.0	1,200	3,460
	25-Aug-20	44	<5.0	1,300	3,550
	19-May-20	19	<2.0	1,100	3,180
	17-Feb-20	46	<5.0	1,300	3,620
	20-Nov-19	35	<5.0	1,300	3,500
	15-Aug-19	41	<1.0	1,300	3,600
	22-May-19	29	<5.0	1,300	3,430
	5-Mar-19	46	<5.0	1,200	3,520
	26-Nov-18	45	<5.0	1,200	3,530
	31-Aug-18	35	<5.0	1,300	3,530
	24-May-18	46	<5.0	1,100	3,350
	22-Feb-18	42	<5.0	1,200	3,530
	17-Nov-17	51.7	<0.0500	931	3,330
	31-Aug-17	42.5	<0.0500	1,220	3,350
	31-May-17	25.9	<0.0501	1,260	3,540
	1-Mar-17	20.9	<0.300	1,290	3,320
	17-Nov-16	22.4	<0.937	1,330	3,560
	29-Aug-16	21.9	<0.937	1,230	3,560
	26-May-16	20.7	<2.24	1,080	3,120
	19-Feb-16	22.3	<1.18	1,190	3,080
	18-Nov-15	20.9	<1.18	958	2,720
	27-Aug-15	22.1	2.80	833	2,350
	22-May-15	19.7	<1.18	999	2,680
	26-Feb-15	18.7	<1.80	1,050	2,970
	24-Nov-14	19.8	<1.80	992	2,680
	21-Aug-14	21.0	<1.80	752	2,320
	29-May-14	15.6	4.20	1,070	3,130
	4-Mar-14	18.5	<1.66	1,170	3,170
	25-Nov-13	17.8	2.80	1,060	2,900
	29-Aug-13	20.9	20.3	911	2,660
21-May-13	14.7	<1.66	1,070	2,920	
26-Feb-13	16.8	<1.72	1,270	3,140	
20-Nov-12	15.0	2.10	1,070	3,100	
15-Aug-12	13.9	<1.72	1,100	3,250	
3-May-12	12.8	<1.72	1,030	2,790	
15-Feb-12	14.9	<2.17	1,230	3,100	
1-Nov-11	12.2	2.24	1,150	2,580	
21-Jul-11	12.0	2.66	1,210	3,180	
29-Apr-11	17.6	<2.17	1,330	3,300	
24-Jan-11	23.2	2.66	1,340	3,430	
24-Sep-10	28.9	<10.0	1,330	3,800	
28-Jun-10	12	<2.0	1,200	3,090	
23-Mar-10	12.2	ND	1,240	2,942	
14-Dec-09	6.7	0.56	1,280	3,096	
31-Aug-09	9.0	ND	1,220	3,152	
1-Jun-09	3.43	ND	1,230	3,026	
2-Mar-09	11	ND	1,255	3,134	

**TABLE 5. DISCHARGE PLAN MONITORING WELL GROUNDWATER ANALYTICAL RESULTS
DONA ANA DAIRIES, DONA ANA COUNTY, NEW MEXICO**

Monitoring Well	Date Sampled	Nitrate as N (mg/l)	TKN (mg/l)	Chloride (mg/l)	TDS (mg/l)
833-06	15-May-23	44	<5.0	820	2,740
	21-Feb-23	14	<2.0	890	2,700
	17-Nov-22	38	<5.0	850	2,610
	17-Aug-22	55	<5.0	770	2,860
	16-May-22	44	<5.0	890	2,840
	23-Feb-22	14	<2.0	880	2,560
	15-Nov-21	50	<5.0	820	2,850
	17-Aug-21	46	<5.0	860	2,680
	18-May-21	46	<5.0	800	2,820
	23-Feb-21	23	<5.0	920	2,630
	18-Nov-20	53	<5.0	760	2,800
	24-Aug-20	70	<5.0	900	2,790
	19-May-20	44	<5.0	820	2,790
	17-Feb-20	19	<2.0	870	2,700
	20-Nov-19	43	<5.0	810	2,660
	15-Aug-19	47	<1.0	880	2,760
	23-May-19	47	<5.0	840	2,740
	5-Mar-19	47	<5.0	780	2,710
	27-Nov-18	24	<5.0	820	2,660
	4-Sep-18	16	<2.0	670	2,260
	29-May-18	11	<2.0	740	2,260
	22-Feb-18	15	<2.0	820	2,500
	16-Nov-17	16.9	<0.0500	786	2,300
	1-Sep-17	18.5	<0.0500	803	2,470
	31-May-17	39.9	<0.0501	800	2,560
	1-Mar-17	40.4	<0.300	792	2,740
	17-Nov-16	43.2	3.41	809	2,680
	26-Aug-16	32.7	<0.937	660	2,640
	27-May-16	28.8	<2.24	711	2,380
	22-Feb-16	22.0	<1.18	706	2,300
	19-Nov-15	51.1	<1.18	752	2,560
	27-Aug-15	32.3	<1.18	708	2,360
	22-May-15	38.6	<1.18	787	2,470
	24-Feb-15	71.9	<1.80	827	3,080
	25-Nov-14	46.5	<1.80	836	2,710
	21-Aug-14	17.4	<1.80	663	2,300
	29-May-14	26.5	3.50	760	2,460
	4-Mar-14	41.9	<1.66	847	2,800
	21-Nov-13	27.4	3.50	771	2,490
	30-Aug-13	25.3	2.80	656	2,310
20-May-13	25.9	<1.66	816	2,640	
25-Feb-13	21.6	<1.72	924	2,750	
19-Nov-12	24.2	<1.72	920	2,840	
15-Aug-12	23.4	<1.72	845	2,670	
3-May-12	20.7	<1.72	702	2,560	
14-Feb-12	26.4	<2.17	727	2,480	
2-Nov-11	28.8	3.08	688	1,900	
21-Jul-11	70.1	7.70	682	2,650	
4-May-11	36.4	7.70	717	2,440	
20-Jan-11	61.0	2.80	738	2,360	
23-Sep-10	64.3	<10.0	761	2,680	
28-Jun-10	23	<5.0	630	2,310	
23-Mar-10	24.8	2.38	700	2,184	
14-Dec-09	22.7	1.68	820	2,344	
31-Aug-09	25.1	1.96	790	2,708	
1-Jun-09	106	ND	680	2,280	
2-Mar-09	66.4	ND	610	2,160	

**TABLE 5. DISCHARGE PLAN MONITORING WELL GROUNDWATER ANALYTICAL RESULTS
DONA ANA DAIRIES, DONA ANA COUNTY, NEW MEXICO**

Monitoring Well	Date Sampled	Nitrate as N (mg/l)	TKN (mg/l)	Chloride (mg/l)	TDS (mg/l)
833-07	16-May-23	92	<5.0	1,300	4,450
	22-Feb-23	70	<5.0	1,200	3,730
	18-Nov-22	63	<5.0	1,200	3,950
	18-Aug-22	91	<5.0	1,200	4,420
	18-May-22	92	<5.0	1,100	4,170
	10-Mar-22	66	<1.0	1,100	3,580
	16-Nov-21	67	<5.0	1,000	3,790
	18-Aug-21	70	<5.0	1,100	3,700
	18-May-21	65	<5.0	1,000	3,680
	24-Feb-21	62	<5.0	1,000	3,430
	19-Nov-20	62	<5.0	970	3,670
	25-Aug-20	68	<5.0	1,100	3,750
	19-May-20	67	<5.0	1,000	3,830
	17-Feb-20	68	<5.0	1,100	3,440
	20-Nov-19	74	<5.0	1,100	3,680
	15-Aug-19	74	<1.0	1,100	3,630
	22-May-19	69	<5.0	1,100	3,760
	4-Mar-19	65	<5.0	1,100	3,680
	26-Nov-18	70	<5.0	1,100	3,630
	31-Aug-18	74	<5.0	1,100	3,800
	24-May-18	74	<5.0	1,000	3,670
	22-Feb-18	63	<5.0	1,000	3,760
	17-Nov-17	68.2	<0.0500	808	3,540
	31-Aug-17	78.7	<0.0500	1,050	3,630
	30-May-17	83.3	<0.0501	1,120	4,080
	1-Mar-17	78.0	<0.300	1,140	3,990
	17-Nov-16	85.3	2.27	1,180	4,180
	29-Aug-16	92.2	<0.937	1,230	5,970
	27-May-16	100	<2.24	1,230	4,620
	18-Feb-16	97.4	<1.18	1,260	4,540
	18-Nov-15	91.0	1.68	1,130	4,150
	27-Aug-15	88.9	2.80	1,350	4,700
	22-May-15	76.7	<1.18	1,320	4,460
	25-Feb-15	86.8	<1.80	1,100	4,320
	24-Nov-14	92.5	<1.80	1,190	4,300
	21-Aug-14	83.6	5.60	1,360	4,920
	29-May-14	87.0	4.90	1,380	4,760
	4-Mar-14	73.0	<1.66	1,390	4,420
	21-Nov-13	78.3	2.80	1,330	4,380
	29-Aug-13	78.4	4.90	1,330	4,420
	21-May-13	88.7	<1.66	1,400	4,730
	26-Feb-13	95.5	<1.72	1,470	4,500
20-Nov-12	95.1	<1.72	1,130	4,290	
15-Aug-12	99.8	2.52	1,540	5,110	
7-May-12	95.6	7.56	1,460	4,880	
15-Feb-12	90.3	<2.17	1,340	4,660	
1-Nov-11	94.2	<2.17	1,090	3,840	
21-Jul-11	105	<2.17	115	4,090	
29-Apr-11	100	<2.17	1,220	4,380	
24-Jan-11	100	2.10	1,140	4,350	
24-Sep-10	129	<10.0	933	3,800	
28-Jun-10	69	<5.0	1,300	4,160	
23-Mar-10	106	ND	1,320	3,884	
14-Dec-09	101	0.42	1,260	3,988	
31-Aug-09	74	8.68	1,180	3,978	
1-Jun-09	12.4	8.68	1,180	3,964	
2-Mar-09	33.2	ND	1,380	3,866	

**TABLE 5. DISCHARGE PLAN MONITORING WELL GROUNDWATER ANALYTICAL RESULTS
DONA ANA DAIRIES, DONA ANA COUNTY, NEW MEXICO**

Monitoring Well	Date Sampled	Nitrate as N (mg/l)	TKN (mg/l)	Chloride (mg/l)	TDS (mg/l)
833-08	16-May-23	49	<5.0	1,100	3,210
	22-Feb-23	30	<5.0	1,300	3,160
	18-Nov-22	25	<5.0	1,100	2,990
	18-Aug-22	47	<5.0	1,200	3,650
	18-May-22	45	<5.0	1,200	3,740
	10-Mar-22	45	<5.0	1,600	4,200
	16-Nov-21	46	<5.0	1,100	3,590
	18-Aug-21	11	<2.0	730	2,360
	18-May-21	35	<5.0	1,200	3,540
	24-Feb-21	36	<5.0	1,300	4,010
	18-Nov-20	32	<5.0	850	3,450
	24-Aug-20	21	<5.0	880	2,650
	19-May-20	38	<5.0	820	2,860
	17-Feb-20	49	<5.0	990	3,110
	20-Nov-19	43	<5.0	850	2,930
	14-Aug-19	46	<1.0	880	3,010
	23-May-19	43	<5.0	900	2,980
	5-Mar-19	48	<5.0	890	3,040
	27-Nov-18	47	<5.0	860	2,950
	4-Sep-18	46	<5.0	830	2,820
	24-May-18	52	<5.0	840	2,980
	22-Feb-18	48	<5.0	890	3,030
	17-Nov-17	54.3	<0.0500	631	2,970
	1-Sep-17	52.3	<0.0500	917	3,250
	31-May-17	67.6	<0.0501	984	3,230
	1-Mar-17	70.3	<0.300	960	3,350
	18-Nov-16	48.3	<0.937	1,020	3,720
	29-Aug-16	25.6	<0.937	1,150	3,310
	27-May-16	46.5	5.19	1,010	3,080
	19-Feb-16	52.9	<1.18	1,140	3,020
	18-Nov-15	56.9	<1.18	533	2,010
	27-Aug-15	55.7	<1.18	569	2,360
	21-May-15	66.4	<1.18	620	2,460
	26-Feb-15	65.1	<1.80	981	3,340
	24-Nov-14	63.7	<1.80	1,130	3,320
	22-Aug-14	90.2	<1.80	672	2,900
	27-May-14	91.5	2.10	772	3,030
	4-Mar-14	100	<1.66	807	3,220
	21-Nov-13	86.3	<1.66	827	3,000
	29-Aug-13	79.6	4.90	971	3,300
21-May-13	80.2	<1.66	953	3,320	
26-Feb-13	83.1	<1.72	877	2,940	
20-Nov-12	60.8	<1.72	1,070	3,580	
15-Aug-12	57.8	2.52	987	3,480	
3-May-12	61.4	<1.72	927	3,040	
15-Feb-12	77.6	<2.17	1,020	3,200	
1-Nov-11	69.8	4.20	966	3,080	
21-Jul-11	68.8	<2.17	963	3,240	
29-Apr-11	75.9	<2.17	950	3,330	
24-Jan-11	93.4	2.10	930	3,190	
23-Sep-10	91.8	<10.0	985	3,600	
28-Jun-10	35	<5.0	630	2,290	
23-Mar-10	33	ND	700	2,108	
14-Dec-09	31	ND	950	2,710	
31-Aug-09	63	ND	1,020	3,576	
1-Jun-09	41.4	ND	1,000	3,492	
2-Mar-09	121	ND	700	2,038	

**TABLE 5. DISCHARGE PLAN MONITORING WELL GROUNDWATER ANALYTICAL RESULTS
DONA ANA DAIRIES, DONA ANA COUNTY, NEW MEXICO**

Monitoring Well	Date Sampled	Nitrate as N (mg/l)	TKN (mg/l)	Chloride (mg/l)	TDS (mg/l)
833-09	17-May-23	110	<5.0	850	4,100
	23-Feb-23	100	<5.0	850	4,160
	21-Nov-22	130	<5.0	840	4,260
	18-Aug-22	190	<5.0	980	5,040
	19-May-22	190	<5.0	1,000	4,700
	10-Mar-22	120	<1.0	910	4,160
	17-Nov-21	110	<5.0	800	3,990
	18-Aug-21	150	<5.0	1,100	4,340
	19-May-21	19	<2.0	690	2,760
	25-Feb-21	21	<5.0	750	2,740
	19-Nov-20	21	<2.0	800	2,750
	25-Aug-20	24	<5.0	790	2,970
	19-May-20	23	8.4	760	2,870
	18-Feb-20	36	<5.0	800	3,100
	21-Nov-19	33	<5.0	750	3,110
	14-Aug-19	32	<5.0	790	3,030
	22-May-19	26	<5.0	790	2,930
	4-Mar-19	45	<5.0	760	3,130
	26-Nov-18	42	<5.0	790	3,140
	4-Sep-18	43	<5.0	810	3,140
	24-May-18	43	<5.0	770	3,110
	21-Feb-18	55	<5.0	730	3,200
	16-Nov-17	59.0	<0.0500	1,190	2,740
	31-Aug-17	51.5	<0.0500	701	3,190
	30-May-17	59.2	<0.0501	799	3,410
	28-Feb-17	65.6	<0.300	779	3,440
	17-Nov-16	64.9	2.27	763	3,410
	26-Aug-16	63.3	<0.937	793	3,440
	26-May-16	71.8	<2.24	726	3,510
	19-Feb-16	112	<1.18	942	3,880
	18-Nov-15	109	<1.18	902	3,860
	27-Aug-15	92.6	<1.18	861	3,580
	21-May-15	123	<1.18	957	4,170
	25-Feb-15	136	<1.80	936	4,450
	25-Nov-14	137	<1.80	965	4,260
	22-Aug-14	64.9	<1.80	759	3,240
	27-May-14	85.0	6.30	868	3,790
	5-Mar-14	125	<1.66	998	4,430
	20-Nov-13	137	<1.66	1,060	4,640
	29-Aug-13	82.2	3.50	786	3,860
22-May-13	78.1	<1.66	786	3,630	
28-Feb-13	101	<1.72	876	4,060	
20-Nov-12	89.6	<1.72	731	3,760	
15-Aug-12	99.3	<1.72	875	3,780	
7-May-12	80.4	<1.72	745	3,830	
15-Feb-12	94.8	<2.17	725	3,580	
1-Nov-11	93.0	<2.17	779	3,880	
21-Jul-11	135	<2.17	1,070	4,550	
4-May-11	147	<2.17	1,420	5,540	
25-Jan-11	134	2.80	1,420	4,850	
24-Sep-10	58.2	<10.0	1,050	4,110	
28-Jun-10	50	<5.0	1,200	4,380	
23-Mar-10	16.3	0.56	1,100	3,624	
14-Dec-09	2.7	0.28	960	3,184	
31-Aug-09	6.6	ND	870	3,178	
1-Jun-09	18.1	1.12	880	3,164	
2-Mar-09	7.07	ND	825	3,202	

**TABLE 5. DISCHARGE PLAN MONITORING WELL GROUNDWATER ANALYTICAL RESULTS
DONA ANA DAIRIES, DONA ANA COUNTY, NEW MEXICO**

Monitoring Well	Date Sampled	Nitrate as N (mg/l)	TKN (mg/l)	Chloride (mg/l)	TDS (mg/l)
833-10	17-May-23	2.2	<1.0	700	2,790
	23-Feb-23	1.5	<1.0	730	2,790
	21-Nov-22	1.6	1.1	680	2,830
	19-Aug-22	1.7	1.3	730	2,830
	19-May-22	1.5	<1.0	740	2,870
	28-Feb-22	1.0	1.1	890	2,830
	17-Nov-21	1.2	<1.0	750	2,800
	18-Aug-21	1.3	<1.0	730	2,750
	19-May-21	<1.0	1.1	700	2,750
	25-Feb-21	<1.0	<1.0	710	2,590
	19-Nov-20	<1.0	<1.0	730	2,650
	25-Aug-20	<1.0	1.1	710	2,710
	20-May-20	<1.0	2.2	700	2,690
	18-Feb-20	<1.0	1.1	680	2,630
	21-Nov-19	1.5	<1.0	630	2,630
	14-Aug-19	2.0	<1.0	660	2,560
	22-May-19	1.8	<1.0	640	2,560
	4-Mar-19	1.8	<1.0	580	2,520
	26-Nov-18	2.6	<1.0	620	2,520
	31-Aug-18	3.3	<1.0	600	2,540
	24-May-18	3.6	<1.0	610	2,510
	22-Feb-18	3.5	<1.0	630	2,480
	16-Nov-17	5.74	0.862	613	2,060
	31-Aug-17	6.75	0.299	606	2,430
	30-May-17	3.83	0.927	650	2,560
	1-Mar-17	3.90	0.396	639	2,670
	17-Nov-16	4.64	<0.937	534	2,620
	26-Aug-16	4.38	<0.937	677	2,660
	26-May-16	4.22	<2.24	637	2,680
	19-Feb-16	2.50	<1.18	691	2,550
	18-Nov-15	2.69	<1.18	660	2,580
	27-Aug-15	3.58	<1.18	678	2,670
	21-May-15	3.81	<1.18	732	2,700
	25-Feb-15	4.52	<1.80	661	2,740
	25-Nov-14	4.96	<1.80	690	2,760
	21-Aug-14	5.66	<1.80	671	2,780
	29-May-14	3.20	2.10	667	2,670
	5-Mar-14	2.47	<1.66	679	2,660
	20-Nov-13	2.93	<1.66	695	2,620
	29-Aug-13	3.77	4.20	642	2,800
22-May-13	3.96	<1.66	648	2,580	
28-Feb-13	4.19	<1.72	689	2,640	
20-Nov-12	4.25	<1.72	608	2,540	
15-Aug-12	4.93	2.52	585	2,530	
7-May-12	3.95	<1.72	581	2,350	
15-Feb-12	3.18	<2.17	582	2,440	
1-Nov-11	3.69	<2.17	573	2,590	
21-Jul-11	4.63	3.78	597	2,480	
4-May-11	5.19	<2.17	714	2,670	
25-Jan-11	8.46	2.10	649	2,730	
24-Sep-10	<10.0	<10.0	654	2,250	
28-Jun-10	3.6	<1.0	750	2,790	
23-Mar-10	6.8	ND	1,220	3,868	
14-Dec-09	3.7	0.14	790	2,576	
31-Aug-09	4.7	ND	750	2,548	
1-Jun-09	7.1	ND	650	2,458	
2-Mar-09	2.43	ND	855	2,954	

**TABLE 5. DISCHARGE PLAN MONITORING WELL GROUNDWATER ANALYTICAL RESULTS
DONA ANA DAIRIES, DONA ANA COUNTY, NEW MEXICO**

Monitoring Well	Date Sampled	Nitrate as N (mg/l)	TKN (mg/l)	Chloride (mg/l)	TDS (mg/l)
Sunset/Desert Land Dairy					
257-01	17-May-23	31	<5.0	860	3,610
	24-Feb-23	30	<5.0	890	3,460
	22-Nov-22	30	<5.0	930	3,440
	19-Aug-22	35	<5.0	920	3,570
	19-May-22	33	<5.0	1,100	3,700
	28-Feb-22	35	<5.0	870	3,400
	17-Nov-21	34	<5.0	940	3,500
	8-Sep-21	36	<5.0	910	3,560
	20-May-21	30	<5.0	890	3,640
	25-Feb-21	32	<5.0	870	3,620
	20-Nov-20	35	<5.0	910	3,610
	25-Aug-20	39	<2.0	960	4,110
	26-May-20	36	<5.0	850	3,640
	18-Feb-20	31	<5.0	890	3,640
	21-Nov-19	35	<5.0	800	3,720
	6-Aug-19	43	<5.0	910	3,740
	21-May-19	41	<5.0	890	3,800
	1-Mar-19	42	<5.0	900	3,620
	27-Nov-18	45	<5.0	890	3,780
	23-Aug-18	43	<5.0	770	3,890
	23-May-18	42	<5.0	900	4,020
	20-Feb-18	50	<5.0	920	3,820
	16-Nov-17	51.1	<0.0500	870	3,740
	18-Aug-17	48.5	<0.0500	867	3,620
	31-May-17	49.3	<0.0501	848	3,570
	2-Mar-17	45.5	<0.300	847	3,860
	16-Nov-16	44.4	<0.300	681	3,940
	25-Aug-16	48.7	<0.937	817	3,620
	26-May-16	47.7	<2.24	797	3,700
	22-Feb-16	51.9	<1.18	873	3,650
	19-Nov-15	49.1	<1.18	821	3,680
	28-Aug-15	50.4	<10.0	816	3,490
	26-May-15	49.4	3.50	809	3,460
	19-Feb-15	27.5	<1.80	629	2,880
	1-Dec-14	47.9	<1.80	750	3,370
	25-Aug-14	49.4	<1.80	694	3,570
	30-May-14	47.9	3.50	739	3,320
	6-Mar-14	44.3	<1.66	707	3,130
	25-Nov-13	42.4	2.80	726	3,090
	28-Aug-13	44.4	5.60	719	3,160
	22-May-13	33.6	<1.66	660	3,100
21-Feb-13	28.3	<1.72	665	3,200	
21-Nov-12	24.7	2.80	625	3,130	
16-Aug-12	23.2	<1.72	617	3,060	
26-Apr-12	23.7	22.7	680	2,920	
9-Feb-12	19.4	<2.17	603	2,940	
1-Nov-11	28.4	<2.17	619	2,730	
22-Jul-11	44.8	<2.17	673	3,270	
26-Apr-11	103	3.78	870	4,440	
19-Jan-11	59.3	3.08	743	3,420	
24-Sep-10	58.0	<10.0	685	3,120	
28-Jun-10	100	<1.0	820	3,800	
24-Mar-10	187	ND	1,100	4,342	
14-Dec-09	71	0.14	910	3,860	
31-Aug-09	49	ND	880	3,706	
2-Jun-09	64	ND	910	3,822	
3-Mar-09	89	ND	1,135	4,652	

**TABLE 5. DISCHARGE PLAN MONITORING WELL GROUNDWATER ANALYTICAL RESULTS
DONA ANA DAIRIES, DONA ANA COUNTY, NEW MEXICO**

Monitoring Well	Date Sampled	Nitrate as N (mg/l)	TKN (mg/l)	Chloride (mg/l)	TDS (mg/l)
257-02	18-May-23	4.6	<1.0	710	2,680
	24-Feb-23	6.7	<2.0	780	2,860
	22-Nov-22	11	<2.0	860	2,780
	19-Aug-22	6.4	<1.0	760	1,370
	19-May-22	6.9	<1.0	730	2,760
	28-Feb-22	9.4	<1.0	600	2,440
	18-Nov-21	39	<5.0	1,000	3,600
	8-Sep-21	20	<5.0	560	2,280
	19-May-21	10	<2.0	770	2,950
	1-Mar-21	13	<2.0	780	2,940
	20-Nov-20	12	<2.0	770	2,930
	26-Aug-20	12	<2.0	790	2,930
	26-May-20	11	<2.0	710	2,810
	18-Feb-20	7.1	<1.0	710	2,680
	21-Nov-19	5.3	<1.0	620	2,690
	6-Aug-19	9.3	<2.0	650	2,590
	21-May-19	10	<1.0	620	2,480
	1-Mar-19	8.7	<1.0	690	2,570
	27-Nov-18	9.1	<1.0	650	2,680
	23-Aug-18	14	<2.0	540	2,640
	23-May-18	14	<2.0	690	2,530
	20-Feb-18	14	<2.0	610	2,640
	16-Nov-17	14.0	1.04	679	2,430
	18-Aug-17	10.3	<0.0500	754	2,890
	31-May-17	10.0	0.492	696	2,520
	2-Mar-17	16.2	<0.300	634	2,760
	16-Nov-16	10.2	<0.937	671	3,090
	25-Aug-16	4.62	<0.937	814	2,940
	26-May-16	7.28	<2.24	572	2,480
	22-Feb-16	4.98	<1.18	455	1,920
	19-Nov-15	12.2	<1.18	800	2,890
	28-Aug-15	8.86	<10.0	632	2,700
	26-May-15	9.36	1.40	727	2,660
	19-Feb-15	8.45	<1.80	610	2,440
	1-Dec-14	6.39	<1.80	669	2,760
	25-Aug-14	6.53	<1.80	585	2,550
	30-May-14	11.5	2.10	531	2,100
	6-Mar-14	10.4	<1.66	530	2,120
	25-Nov-13	11.1	2.80	529	2,070
	28-Aug-13	7.59	8.40	511	2,200
22-May-13	3.39	<1.66	469	1,880	
21-Feb-13	10.3	<1.72	470	1,980	
21-Nov-12	10.0	2.80	468	2,060	
16-Aug-12	14.8	<1.72	484	2,170	
26-Apr-12	23.2	8.40	505	1,840	
9-Feb-12	11.1	<2.17	443	1,840	
1-Nov-11	19.3	2.24	442	3,150	
22-Jul-11	28.7	<2.17	501	2,160	
26-Apr-11	24.9	2.80	433	2,000	
19-Jan-11	13.3	2.52	455	1,500	
24-Sep-10	21.0	<10.0	445	1,590	
29-Jun-10	24	<1.0	560	2,180	
24-Mar-10	22.3	ND	570	1,840	
14-Dec-09	19.3	0.14	480	1,916	
31-Aug-09	14.2	ND	410	1,518	
2-Jun-09	1.86	ND	500	1,690	
3-Mar-09	30.4	ND	495	1,632	

**TABLE 5. DISCHARGE PLAN MONITORING WELL GROUNDWATER ANALYTICAL RESULTS
DONA ANA DAIRIES, DONA ANA COUNTY, NEW MEXICO**

Monitoring Well	Date Sampled	Nitrate as N (mg/l)	TKN (mg/l)	Chloride (mg/l)	TDS (mg/l)
257-03	17-May-23	Not Sampled - Unknown Blockage in Well			
	23-Feb-23	Not Sampled - Unknown Blockage in Well			
	22-Nov-22	11	2.0	630	2,630
	22-Aug-22	5.2	2.0	570	2,620
	19-May-22	Not Sampled - Unknown Blockage in Well			
	28-Feb-22	Not Sampled - Unknown Blockage in Well			
	18-Nov-21	Not Sampled - Unknown Blockage in Well			
	8-Sep-21	15	<2.0	780	2,900
	20-May-21	Not Sampled - Insufficient water to sample			
	1-Mar-21	17	2.2	700	2,870
	20-Nov-20	19	2.5	590	2,890
	26-Aug-20	9.9	3.6	720	2,830
	26-May-20	Dry			
	18-Feb-20	16	2.2	660	2,730
	21-Nov-19	4.4	1.8	570	2,640
	6-Aug-19	5.9	2.2	750	2,900
	21-May-19	Dry			
	1-Mar-19	12	<2.0	710	2,670
	27-Nov-18	5.8	2.1	570	2,480
	23-Aug-18	11	<2.0	600	2,760
	23-May-18	11	2.5	430	2,060
	20-Feb-18	12	2.2	530	2,510
	16-Nov-17	13.8	1.99	523	2,150
	18-Aug-17	14.3	0.742	605	2,540
	31-May-17	10.1	1.13	402	2,330
	2-Mar-17	15.4	0.412	346	2,220
	16-Nov-16	12.50	1.70	344	1,860
	25-Aug-16	9.97	<0.937	333	1,860
	26-May-16	Dry			
	22-Feb-16	Not Sampled - insufficient water to sample			
	19-Nov-15	Dry			
	28-Aug-15	5.37	<10.0	477	2,060
	26-May-15	Dry			
	19-Feb-15	Not Sampled - insufficient water to sample			
	1-Dec-14	Dry			
	25-Aug-14	7.64	<1.80	413	1,840
	30-May-14	Dry			
	6-Mar-14	6.06	<1.66	546	2,380
	25-Nov-13	2.03	4.90	494	1,900
	28-Aug-13	4.55	4.90	569	2,360
	22-May-13	7.23	<1.66	658	2,640
	21-Feb-13	2.65	<1.72	520	2,060
	21-Nov-12	3.11	2.80	490	2,250
	16-Aug-12	17.6	2.10	509	2,420
	26-Apr-12	6.60	4.20	601	2,330
	14-Feb-12	11.2	<2.17	636	2,620
	1-Nov-11	7.37	2.80	537	2,210
	22-Jul-11	12.9	2.80	576	2,100
	26-Apr-11	12.5	5.88	525	2,400
	19-Jan-11	2.67	2.24	377	1,600
24-Sep-10	8.00	<10.0	400	1,670	
29-Jun-10	17	1.1	660	2,570	
24-Mar-10	10.1	1.12	640	2,342	
14-Dec-09	5.9	0.56	760	2,638	
31-Aug-09	10.7	0.84	610	2,260	
2-Jun-09	5.99	ND	570	2,284	
3-Mar-09	334*	ND	690	2,538	

**TABLE 5. DISCHARGE PLAN MONITORING WELL GROUNDWATER ANALYTICAL RESULTS
DONA ANA DAIRIES, DONA ANA COUNTY, NEW MEXICO**

Monitoring Well	Date Sampled	Nitrate as N (mg/l)	TKN (mg/l)	Chloride (mg/l)	TDS (mg/l)
257/260-01	2-Feb-18	Plugged and Abandoned			
	16-Nov-17	Not Sampled - Inaccessible Due to Crops			
	18-Aug-17	0.0935	18.6	678	2,730
	31-May-17	0.193	28.3	665	2,460
	2-Mar-17	<2.00	83.7	636	2,720
	16-Nov-16	0.857	29.2	527	2,300
	9-Sep-16	16.7	5.11	254	1,660
	26-May-16	<0.305	12.1	588	2,460
	22-Feb-16	<0.305	37.0	598	2,830
	19-Nov-15	<0.194	15.7	542	2,260
	28-Aug-15	8.81	<10.0	210	1,140
	26-May-15	2.02	18.9	726	2,750
	19-Feb-15	1.09	<1.80	445	2,220
	1-Dec-14	4.92	2.80	375	1,520
	25-Aug-14	3.74	6.30	562	2,440
	30-May-14	4.82	2.10	658	2,640
	6-Mar-14	4.22	<1.66	644	2,780
	25-Nov-13	3.30	6.30	580	2,220
	28-Aug-13	2.81	7.70	624	2,460
	22-May-13	2.39	<1.66	673	2,820
	21-Feb-13	9.35	<1.72	816	2,980
	21-Nov-12	13.0	3.50	722	3,020
	16-Aug-12	3.67	6.30	667	2,620
	26-Apr-12	6.83	2.80	575	2,660
	14-Feb-12	9.68	<2.17	565	2,180
	1-Nov-11	16.7	2.94	658	2,850
	22-Jul-11	4.66	3.64	440	1,860
	26-Apr-11	<0.500	4.34	624	2,580
	19-Jan-11	1.21	4.20	480	1,860
	24-Sep-10	11.0	<10.0	576	2,480
	30-Jun-10	5.4	<5.0	530	1,980
23-Mar-10	5.0	ND	340	982	
14-Dec-09	45	26.32	220	520	
31-Aug-09	0.3	8.7	570	1,704	
2-Jun-09	1.65	7.0	660	1,936	
3-Mar-09	3.98	1.12	555	1,908	

**TABLE 5. DISCHARGE PLAN MONITORING WELL GROUNDWATER ANALYTICAL RESULTS
DONA ANA DAIRIES, DONA ANA COUNTY, NEW MEXICO**

Monitoring Well	Date Sampled	Nitrate as N (mg/l)	TKN (mg/l)	Chloride (mg/l)	TDS (mg/l)
Las Cruces Community Farms (Former McAnally Enterprises)					
MW-4	18-May-23	<1.0	<1.0	1,500	4,700
	24-Feb-23	1.1	<1.0	1,400	4,290
	22-Nov-22	<1.0	<1.0	1,500	4,640
	22-Aug-22	1.3	<1.0	1,800	5,140
	20-May-22	1.5	<1.0	1,300	4,170
	28-Feb-22	1.3	<1.0	1,300	4,150
	18-Nov-21	2.7	<1.0	1,200	3,860
	8-Sep-21	1.8	<1.0	1,400	4,270
	20-May-21	2.2	<1.0	1,300	3,980
	1-Mar-21	1.5	<1.0	1,600	4,820
	20-Nov-20	1.1	<1.0	1,500	4,550
	26-Aug-20	1.2	<1.0	1,500	4,640
	26-May-20	<1.0	1.1	1,400	4,460
	6-Mar-20	<1.0	<2.0	1,600	4,620
	26-Nov-19	0.39	<1.0	1,400	4,800
	19-Jun-18	4.6	<1.0	1,200	980
	21-Jul-15	1.6	<1	1,900	5,300
9-Jun-15	1.5	<1.0	1,900	5,100	
13-Mar-09	3.5	<0.5	2,110	5,686	
NMWQCC Standard		10	NA	250	1,000
Existing Conditions - August 2020		NA	NA	367	1,758
Existing Conditions - Pre-August 2020*		NA	NA	1,718	5,328
Southern Area					
Del Oro Dairy					
692-01 (Perched)	22-Dec-15	Plugged & Abandoned			
	2-Dec-15	78.4	<1.18	579	2,420
	31-Aug-15	Pump was not operational			
	28-May-15	Pump was not operational			
	3-Mar-15	Pump was not operational			
	2-Dec-14	99.4	4.90	678	2,830
	27-Aug-14	95.6	9.10	643	2,910
	2-Jun-14	98.2	4.20	612	2,660
	13-Mar-14	97.8	<1.66	647	2,820
	4-Dec-13	2.57	7.00	706	2,840
	4-Sep-13	Not Sampled			
	28-May-13	82.4	<1.66	612	2,660
	27-Feb-13	87.9	<1.72	654	2,690
	30-Nov-12	117	<1.72	821	3,490
	20-Aug-12	Pump was not operational			
	8-May-12	163	<1.72	1,060	4,820
	17-Feb-12	166	7.28	1,090	4,000
	8-Nov-11	168	6.44	1,180	4,690
	29-Jul-11	176	<2.17	1,210	4,840
	22-Apr-11	140		998	3,880
	19-Jan-11	213	2.10	1,070	4,320
	1-Oct-10	222	<10.0	1,060	4,640
	30-Jun-10	230	<5.0	1,100	4,080
30-Mar-10	117.5	3	1,080	3,991	
8-Dec-09	107	1	1,060	4,897	
12-Aug-09	127	3	1,120	4,955	
4-May-09	120	3	1,160	4,295	

**TABLE 5. DISCHARGE PLAN MONITORING WELL GROUNDWATER ANALYTICAL RESULTS
DONA ANA DAIRIES, DONA ANA COUNTY, NEW MEXICO**

Monitoring Well	Date Sampled	Nitrate as N (mg/l)	TKN (mg/l)	Chloride (mg/l)	TDS (mg/l)
692-02 (Perched)	18-May-23	25	<5.0	440	1,590
	27-Feb-23	21	<5.0	410	1,430
	28-Nov-22	17	<2.0	360	1,410
	22-Aug-22	11	<2.0	350	1,260
	20-May-22	4.4	<1.0	300	1,050
	1-Mar-22	5.0	<1.0	300	1,060
	19-Nov-21	1.1	<1.0	270	953
	23-Aug-21	<1.0	<1.0	290	912
	20-May-21	<1.0	<1.0	280	892
	9-Mar-21	<1.0	<1.0	270	877
	23-Nov-20	<1.0	<1.0	250	879
	26-Aug-20	<1.0	<1.0	280	871
	26-May-20	<1.0	<1.0	280	868
	19-Feb-20	<1.0	<1.0	270	882
	2-Dec-19	<1.0	<1.0	260	890
	15-Aug-19	2.2	<1.0	380	1,210
	29-May-19	2.5	<1.0	290	964
	7-Mar-19	67	<5.0	640	2,560
	27-Nov-18	58	<5.0	620	2,440
	23-Aug-18	66	<5.0	610	2,690
	30-May-18	64	<5.0	690	2,770
	23-Feb-18	82	<5.0	840	2,960
	30-Nov-17	43.4	<0.0500	746	2,300
	23-Aug-17	24.4	<0.0500	660	2,290
	5-Jun-17	2.82	1.01	421	1,640
	2-Mar-17	17.8	<0.300	583	2,250
	30-Nov-16	103	<0.300	803	3,300
	6-Sep-16	111	<0.937	869	3,340
	31-May-16	124	<2.24	879	3,520
	24-Feb-16	140	<1.18	990	3,480
	2-Dec-15	134	2.24	967	3,500
	31-Aug-15	140	4.90	995	3,660
	26-May-15	140	4.20	973	3,430
	3-Mar-15	142	2.10	963	3,640
	2-Dec-14	147	<1.80	974	3,430
	27-Aug-14	132	2.80	909	3,510
	30-May-14	128	4.20	906	3,370
	7-Mar-14	129	<1.66	912	3,420
	3-Dec-13	108	2.80	906	3,520
	4-Sep-13	120	2.80	925	3,600
	23-May-13	47.8	<1.66	742	2,720
	27-Feb-13	3.37	<1.72	396	1,520
	30-Nov-12	<0.0290	<1.72	358	1,450
	20-Aug-12	1.72	<1.72	371	1,460
	8-May-12	1.75	<1.72	339	1,350
	17-Feb-12	2.55	<2.17	410	1,490
	31-Oct-11	4.69	<2.17	451	1,720
29-Jul-11	24.1	<2.17	504	2,280	
27-Apr-11	92.3	<10.0	921	3,080	
26-Jan-11	47.2	3.64	706	2,490	
1-Oct-10	Not Sampled				
30-Jun-10	140	<5.0	1,100	3,520	
30-Mar-10	107.5	1	1,320	3,861	
8-Dec-09	96	1	1,200	4,073	
12-Aug-09	66	3	1,140	4,317	
4-May-09	52	1	1,100	3,337	

**TABLE 5. DISCHARGE PLAN MONITORING WELL GROUNDWATER ANALYTICAL RESULTS
DONA ANA DAIRIES, DONA ANA COUNTY, NEW MEXICO**

Monitoring Well	Date Sampled	Nitrate as N (mg/l)	TKN (mg/l)	Chloride (mg/l)	TDS (mg/l)
692-03	30-Mar-10	Plugged and Abandoned			
	4-May-09				
692-04 (Perched)	18-May-23	Dry			
	27-Feb-23				
	28-Nov-22				
	23-Aug-22	Not Sampled - insufficient water to sample			
	20-May-22	57	<5.0	680	2,570
	1-Mar-22	29	<5.0	570	2,460
	19-Nov-21	33	<5.0	520	2,460
	20-Aug-21	Not Sampled - insufficient water to sample			
	20-May-21				
	9-Mar-21	15	4.5	540	1,810
	23-Nov-20	18	9.5	520	2,350
	26-Aug-20	24	15	640	2,370
	26-May-20	69	2.8	910	3,240
	19-Feb-20	49	<5.0	680	2,460
	2-Dec-19	48	<5.0	610	2,450
	15-Aug-19	29	4.80	600	2,230
	29-May-19	Dry			
	7-Mar-19	Dry			
	27-Nov-08	Dry			
	23-Aug-18	Dry			
	30-May-18	Dry			
	23-Feb-18	Dry			
	23-Aug-17	Dry			
	5-Jun-17	Dry			
	2-Mar-17	Dry			
	30-Nov-16	Dry			
	2-Sep-16	Dry			
	31-May-16	Dry			
	24-Feb-16	Dry			
	2-Dec-15	Dry			
	31-Aug-15	Dry			
	26-May-15	Dry			
	3-Mar-15	Not Sampled - insufficient water to sample			
	2-Dec-14	27.1	<1.80	582	2,000
	28-Aug-14	32.5	<1.80	508	2,060
	30-May-14	38.7	4.20	481	2,010
	7-Mar-14	44.4	<1.66	581	2,290
	3-Dec-13	43.5	2.80	646	2,490
	4-Sep-13	Not Sampled - insufficient water to sample			
	23-May-13	71.3	<1.66	676	2,740
	27-Feb-13	25.2	<1.72	625	2,390
30-Nov-12	24.3	<1.72	573	2,540	
20-Aug-12	42.1	<1.72	689	2,850	
8-May-12	39.6	<1.72	652	2,490	
17-Feb-12	30.2	<2.17	557	2,060	
31-Oct-11	22.9	<2.17	477	1,600	
29-Jul-11	25.2	<2.17	503	1,960	
22-Apr-11	98.5	<2.17	893	3,240	
19-Jan-11	148	3.22	1,040	3,740	
28-Sep-10	67.0	<10.0	802	3,060	
30-Jun-10	50	<5.0	590	2,050	
30-Mar-10	28	1	600	2,012	
8-Dec-09	31	1	590	2,069	
12-Aug-09	26	1	680	2,158	
4-May-09	26	1	580	2,081	

**TABLE 5. DISCHARGE PLAN MONITORING WELL GROUNDWATER ANALYTICAL RESULTS
DONA ANA DAIRIES, DONA ANA COUNTY, NEW MEXICO**

Monitoring Well	Date Sampled	Nitrate as N (mg/l)	TKN (mg/l)	Chloride (mg/l)	TDS (mg/l)	
692-05 (Regional)	23-May-23	14	<2.0	400	1,500	
	28-Feb-23	16	<2.0	430	1,560	
	30-Nov-22	18	<2.0	390	1,610	
	23-Aug-22	17	<2.0	430	1,600	
	20-May-22	15	<1.0	380	1,550	
	2-Mar-22	16	<2.0	400	1,550	
	19-Nov-21	19	<2.0	400	1,600	
	23-Aug-21	18	<2.0	430	1,570	
	21-May-21	14	<2.0	430	1,620	
	9-Mar-21	17	<1.0	410	1,550	
	23-Nov-20	14	<2.0	400	1,580	
	27-Aug-20	14	<2.0	410	1,580	
	27-May-20	12	<2.0	400	1,640	
	19-Feb-20	14	<2.0	420	1,780	
	2-Dec-19	13	<2.0	390	1,510	
	16-Aug-19	12	<2.0	420	1,570	
	29-May-19	13	<2.0	420	1,600	
	14-Mar-19	12	<2.0	410	1,540	
	4-Dec-18	Pump was not operational				
	23-Aug-18	9.1	<1.0	400	1,500	
	30-May-18	Pump was not operational				
	23-Feb-18	Pump was not operational				
	30-Nov-17	11.9	<0.0500	433	1,300	
	22-Aug-17	10.6	<0.0500	450	1,470	
	5-Jun-17	9.24	<0.0500	440	1,430	
	3-Mar-17	8.32	<0.300	425	1,430	
	29-Nov-16	6.85	<0.300	430	1,420	
	2-Sep-16	8.07	<0.937	452	1,420	
	31-May-16	7.29	<2.24	459	1,470	
	24-Feb-16	6.72	<1.18	463	1,540	
	2-Dec-15	5.68	<1.18	457	1,370	
	31-Aug-15	5.03	11.9	496	1,380	
	26-May-15	3.93	<1.18	474	1,440	
	3-Mar-15	3.70	<1.80	430	1,440	
	2-Dec-14	4.80	<1.80	447	1,460	
	27-Aug-14	5.78	<1.80	424	1,340	
	2-Jun-14	6.50	3.50	427	1,460	
	14-Mar-14	1.67	<1.66	452	1,440	
	4-Dec-13	4.05	2.80	437	1,360	
	4-Sep-13	2.12	4.20	446	1,480	
	28-May-13	1.90	<1.66	417	1,280	
	27-Feb-13	2.16	<1.72	410	1,340	
	29-Nov-12	2.28	<1.72	397	1,370	
	16-Aug-12	2.73	17.6	455	1,520	
	7-May-12	1.92	3.08	420	1,570	
	17-Feb-12	2.52	<2.17	423	1,310	
	8-Nov-11	2.30	2.94	383	1,230	
	1-Aug-11	<1.00	3.50	420	1,710	
	26-Apr-11	<2.50	<10.0	401	1,710	
	19-Jan-11	4.12	2.10	443	1,280	
1-Oct-10	3.10	<10.0	420	1,430		
30-Jun-10	2.1	<1.0	500	1,490		
30-Mar-10	1.5	1	480	1,501		
8-Dec-09	1.4	1	540	1,538		
12-Aug-09	0.8	1	500	1,602		
4-May-09	1.0	1	500	1,477		

**TABLE 5. DISCHARGE PLAN MONITORING WELL GROUNDWATER ANALYTICAL RESULTS
DONA ANA DAIRIES, DONA ANA COUNTY, NEW MEXICO**

Monitoring Well	Date Sampled	Nitrate as N (mg/l)	TKN (mg/l)	Chloride (mg/l)	TDS (mg/l)
692-06 (Regional)	23-May-23	4.8	<1.0	390	1,410
	28-Feb-23	4.6	<1.0	440	1,430
	30-Nov-22	4.6	<1.0	390	1,470
	23-Aug-22	4.9	<1.0	440	1,490
	23-May-22	3.9	<1.0	420	1,420
	2-Mar-22	3.7	<1.0	400	1,380
	22-Nov-21	4.3	<1.0	430	1,500
	24-Aug-21	3.6	<1.0	410	1,490
	21-May-21	3.4	<1.0	420	1,470
	11-Mar-21	3.0	<1.0	390	1,390
	24-Nov-20	4.0	<1.0	420	1,470
	27-Aug-20	3.6	<1.0	400	1,450
	27-May-20	3.1	4.1	370	1,440
	18-Feb-20	3.2	<1.0	420	1,400
	26-Nov-19	4.0	<1.0	420	1,490
	15-Aug-19	3.8	<1.0	420	1,440
	29-May-19	3.3	<1.0	400	1,430
	7-Mar-19	3.1	<1.0	420	1,450
	4-Dec-18	3.7	<1.0	450	1,490
	23-Aug-18	3.5	<1.0	370	1,450
	30-May-18	3.9	<1.0	410	1,420
	23-Feb-18	2.9	<1.0	420	1,430
	30-Nov-17	3.46	<0.0500	420	1,290
	23-Aug-17	3.29	<0.0500	420	1,480
	5-Jun-17	3.20	0.0835	428	1,580
	2-Mar-17	2.84	<0.300	404	1,530
	30-Nov-16	3.12	<0.300	414	1,420
	6-Sep-16	2.86	<0.937	471	1,420
	31-May-16	2.27	<2.24	467	1,420
	24-Feb-16	2.93	<1.18	465	1,410
	2-Dec-15	3.04	<1.18	450	1,420
	31-Aug-15	2.56	<1.18	444	1,400
	26-May-15	4.29	1.40	480	1,410
	3-Mar-15	3.40	<1.80	444	1,440
	2-Dec-14	3.65	<1.80	461	1,440
	27-Aug-14	3.77	<1.80	434	1,420
	2-Jun-14	3.90	3.50	453	1,500
	7-Mar-14	3.03	<1.66	429	1,400
	3-Dec-13	3.70	2.10	470	1,470
	4-Sep-13	3.19	2.10	423	1,540
	23-May-13	2.71	<1.66	415	1,370
	27-Feb-13	2.81	<1.72	412	1,390
	4-Dec-12	2.19	<1.72	395	1,380
	16-Aug-12	3.24	3.36	418	1,400
	8-May-12	2.62	<1.72	397	1,620
17-Feb-12	9.39	<2.17	459	1,200	
8-Nov-11	6.46	<2.17	425	1,450	
1-Aug-11	6.07	2.80	409	1,500	
26-Apr-11	4.50	<10.0	422	1,590	
19-Jan-11	4.95	2.10	431	1,360	
1-Oct-10	11.0	<10.0	373	1,490	
30-Jun-10	7.4	<1.0	440	1,470	
30-Mar-10	3.9	1	460	1,532	
8-Dec-09	2.3	1	540	1,609	
12-Aug-09	2.8	1	440	1,555	
4-May-09	2.9	1	500	1,552	

**TABLE 5. DISCHARGE PLAN MONITORING WELL GROUNDWATER ANALYTICAL RESULTS
DONA ANA DAIRIES, DONA ANA COUNTY, NEW MEXICO**

Monitoring Well	Date Sampled	Nitrate as N (mg/l)	TKN (mg/l)	Chloride (mg/l)	TDS (mg/l)	
692-07 (Regional)	24-May-23	3.0	<1.0	510	1,510	
	28-Feb-23	2.7	<1.0	540	1,560	
	1-Dec-22	3.0	<1.0	540	1,650	
	24-Aug-22	3.2	<1.0	480	1,720	
	23-May-22	3.6	<1.0	570	1,670	
	2-Mar-22	2.5	<1.0	510	1,530	
	22-Nov-21	3.1	<1.0	580	1,700	
	24-Aug-21	3.9	<1.0	590	1,760	
	21-May-21	3.6	<1.0	570	1,620	
	11-Mar-21	2.8	<5.0	540	1,640	
	24-Nov-20	3.5	<1.0	590	1,620	
	27-Aug-20	3.2	<1.0	570	1,720	
	19-Jun-20	2.9	<2.0	550	1,790	
	19-Feb-20	Not Sampled - insufficient water to sample				
	26-Nov-19	3.4	<1.0	570	1,650	
	16-Aug-19	3.9	<1.0	540	1,700	
	29-May-19	3.1	<1.0	560	1,690	
	7-Mar-19	3.5	<1.0	580	1,680	
	4-Dec-18	3.5	<1.0	560	1,640	
	23-Aug-18	3.3	<1.0	500	1,650	
	30-May-18	3.3	<1.0	590	1,600	
	23-Feb-18	2.9	<1.0	610	1,630	
	30-Nov-17	3.38	<0.0500	576	1,450	
	23-Aug-17	3.38	<0.0500	576	1,590	
	5-Jun-17	3.18	0.471	570	1,520	
	3-Mar-17	3.14	<0.300	564	1,550	
	29-Nov-16	3.88	<0.300	570	1,660	
	2-Sep-16	3.04	<0.937	591	1,520	
	31-May-16	2.19	<2.24	526	1,660	
	24-Feb-16	3.42	<1.18	618	1,590	
	2-Dec-15	3.13	<1.18	582	1,490	
	31-Aug-15	2.97	<1.18	578	1,570	
	26-May-15	2.93	<1.18	589	1,580	
	3-Mar-15	3.53	<1.80	668	1,580	
	2-Dec-14	Pump was not operational				
	27-Aug-14	Not Sampled - insufficient water to sample				
	2-Jun-14	3.20	2.80	527	1,590	
	14-Mar-14	3.26	<1.66	544	1,580	
	4-Dec-13	4.26	2.10	581	1,600	
	4-Sep-13	4.17	<1.66	550	1,840	
	28-May-13	3.68	<1.66	524	1,530	
	27-Feb-13	3.82	<1.72	563	1,630	
	30-Nov-12	4.05	<1.72	535	1,660	
	16-Aug-12	5.36	3.50	549	1,780	
	8-May-12	3.55	<1.72	530	1,780	
	17-Feb-12	4.76	<2.17	518	1,600	
	12-Nov-11	5.22	<2.17	555	780	
1-Aug-11	<1.00	2.66	567	2,000		
26-Apr-11	39.3	<10.0	694	2,520		
19-Jan-11	17.2	2.38	589	1,100		
1-Oct-10	27.0	< 10.0	617	2,300		
30-Jun-10	Not Sampled					
30-Mar-10	42	1	820	2,967		
8-Dec-09	28	1	860	3,131		
12-Aug-09	36	1	780	3,041		
4-May-09	50	1	960	3,480		

**TABLE 5. DISCHARGE PLAN MONITORING WELL GROUNDWATER ANALYTICAL RESULTS
DONA ANA DAIRIES, DONA ANA COUNTY, NEW MEXICO**

Monitoring Well	Date Sampled	Nitrate as N (mg/l)	TKN (mg/l)	Chloride (mg/l)	TDS (mg/l)
692-08 (Regional)	24-May-23	5.2	<1.0	360	1,290
	1-Mar-23	3.0	<1.0	430	1,330
	1-Dec-22	1.6	<1.0	420	1,370
	24-Aug-22	1.9	<1.0	360	1,370
	23-May-22	6.2	<1.0	400	1,380
	2-Mar-22	5.0	<1.0	390	1,370
	22-Nov-21	6.8	<1.0	380	1,400
	24-Aug-21	2.1	<1.0	410	1,390
	21-May-21	1.7	<2.0	410	1,390
	11-Mar-21	2.3	<1.0	400	1,350
	24-Nov-20	2.1	<1.0	390	1,360
	27-Aug-20	1.9	<1.0	430	1,400
	27-May-20	1.4	<1.0	400	1,400
	18-Feb-20	3.9	<1.0	430	1,380
	25-Nov-19	1.8	<1.0	360	1,350
	16-Aug-19	1.2	<1.0	390	1,340
	29-May-19	2.8	<1.0	410	1,380
	7-Mar-19	2.6	<1.0	420	1,400
	4-Dec-18	2.4	<1.0	420	1,370
	23-Aug-18	2.1	<1.0	370	1,380
	30-May-18	2.5	<1.0	420	1,340
	23-Feb-18	3.0	<1.0	410	1,360
	30-Nov-17	4.74	<0.0500	420	1,280
	22-Aug-17	2.29	<0.0500	416	1,370
	5-Jun-17	2.12	1.93	413	1,300
	3-Mar-17	2.84	<0.300	412	1,270
	30-Nov-16	2.26	0.567	422	1,340
	2-Sep-16	0.791	1.14	473	1,320
	31-May-16	1.58	<2.24	437	1,340
	24-Feb-16	3.22	<1.18	448	1,300
	2-Dec-15	1.91	<1.18	434	1,330
	31-Aug-15	<0.194	<1.18	432	1,380
	28-May-15	0.652	<1.18	460	1,430
	2-Mar-15	3.34	<1.80	433	1,360
	2-Dec-14	2.65	<1.80	437	1,370
	27-Aug-14	2.71	<1.80	418	1,300
	2-Jun-14	4.70	4.90	435	1,300
	14-Mar-14	4.27	<1.66	435	1,430
	4-Dec-13	3.22	<1.66	456	1,320
	4-Sep-13	3.58	2.10	430	1,360
	28-May-13	3.49	<1.66	434	2,760
	27-Feb-13	6.27	<1.72	424	1,380
	30-Nov-12	11.70	<1.72	393	1,500
	20-Aug-12	2.98	<1.72	410	1,340
	8-May-12	1.84	<1.72	364	1,560
17-Feb-12	3.94	<2.17	452	1,390	
8-Nov-11	2.60	2.80	436	1,340	
1-Aug-11	<1.00	<2.17	386	2,240	
26-Apr-11	3.49	<10.0	435	1,440	
19-Jan-11	3.26	<2.05	431	1,120	
1-Oct-10	5.70	<10.0	386	1,390	
30-Jun-10	3.5	<1.0	460	1,430	
30-Mar-10	3.0	1	520	1,518	
8-Dec-09	2.5	1	500	1,459	
12-Aug-09	1.8	1	520	1,476	
4-May-09	2.0	1	480	1,476	

**TABLE 5. DISCHARGE PLAN MONITORING WELL GROUNDWATER ANALYTICAL RESULTS
DONA ANA DAIRIES, DONA ANA COUNTY, NEW MEXICO**

Monitoring Well	Date Sampled	Nitrate as N (mg/l)	TKN (mg/l)	Chloride (mg/l)	TDS (mg/l)	
692-09 (Regional)	23-May-23	7.0	<1.0	380	1,380	
	28-Feb-23	8.2	<1.0	400	1,400	
	30-Nov-22	8.4	<1.0	370	1,430	
	23-Aug-22	5.4	<1.0	410	1,420	
	20-May-22	7.4	<1.0	370	1,410	
	1-Mar-22	8.5	<1.0	360	1,460	
	19-Nov-21	5.3	<1.0	410	1,420	
	23-Aug-21	3.6	<1.0	410	1,370	
	20-May-21	3.2	<1.0	400	1,420	
	9-Mar-21	8.2	<1.0	390	1,380	
	23-Nov-20	3.4	<1.0	380	1,370	
	26-Aug-20	4.7	<1.0	400	1,410	
	27-May-20	3.9	<1.0	380	1,400	
	19-Feb-20	Not Sampled - insufficient water to sample				
	2-Dec-19	6.4	<1.0	350	1,420	
	16-Aug-19	5.4	<1.0	380	1,410	
	29-May-19	3.9	<1.0	390	1,390	
	7-Mar-19	3.0	<1.0	390	1,400	
	4-Dec-18	3.2	<1.0	400	1,410	
	23-Aug-18	3.1	<1.0	350	1,410	
	30-May-18	4.2	<1.0	410	1,420	
	23-Feb-18	<1.0	<1.0	410	1,380	
	30-Nov-17	0.746	<0.0500	405	970	
	22-Aug-17	3.93	<0.0500	411	1,360	
	5-Jun-17	2.76	1.47	408	1,340	
	3-Mar-17	4.22	<0.300	399	1,320	
	30-Nov-16	4.39	<0.300	420	1,380	
	2-Sep-16	0.794	<0.937	426	1,340	
	31-May-16	2.96	<2.24	438	1,400	
	24-Feb-16	3.38	<1.18	445	1,280	
	2-Dec-15	2.88	<1.18	435	1,320	
	31-Aug-15	3.04	<1.18	434	1,290	
	28-May-15	2.85	<1.18	460	1,380	
	3-Mar-15	2.35	<1.80	428	1,300	
	2-Dec-14	1.94	<1.80	444	1,420	
	28-Aug-14	4.36	<1.80	418	1,450	
	2-Jun-14	6.81	<1.80	459	1,300	
	14-Mar-14	6.08	<1.66	453	1,460	
	4-Dec-13	3.43	2.10	465	1,440	
	4-Sep-13	8.52	3.50	452	1,460	
	28-May-13	8.92	<1.66	457	1,410	
	27-Feb-13	9.50	<1.72	465	1,440	
	29-Nov-12	7.91	13.3	425	1,410	
	20-Aug-12	7.71	<1.72	400	1,480	
	7-May-12	7.80	<1.72	391	1,470	
	17-Feb-12	6.89	<2.17	457	1,450	
	8-Nov-11	10.6	<2.17	455	1,400	
	1-Aug-11	12.6	<2.17	407	1,300	
	26-Apr-11	10.8	<10.0	420	1,140	
	18-Jan-11	12.0	<2.05	460	1,160	
1-Oct-10	15.0	<10.0	387	1,480		
30-Jun-10	22	<5.0	480	1,500		
30-Mar-10	11	1	520	1,606		
8-Dec-09	10	1	460	1,536		
12-Aug-09	6	1	460	1,675		
4-May-09	6	1	480	1,545		

**TABLE 5. DISCHARGE PLAN MONITORING WELL GROUNDWATER ANALYTICAL RESULTS
DONA ANA DAIRIES, DONA ANA COUNTY, NEW MEXICO**

Monitoring Well	Date Sampled	Nitrate as N (mg/l)	TKN (mg/l)	Chloride (mg/l)	TDS (mg/l)
692-10 (Regional)	24-May-23	<1.0	<2.0	630	1,520
	1-Mar-23	<1.0	<1.0	640	1,540
	30-Nov-22	<1.0	1.4	610	1,830
NMWQCC Standard		10	NA	250	1,000
Existing Conditions - August 2020		NA	NA	455	1,424
Existing Conditions - Pre-August 2020*		NA	NA	503	2,552

NOTES:

Data suspect

* = Pre-August 2020 existing conditions were in place prior to August 2020. This condition is no longer applicable.

mg/l = milligrams per liter

ND = Non-detect

NMWQCC = New Mexico Water Quality Control Commission

TDS = Total dissolved solids

TKN = Total Kjeldahl nitrogen

Data from current quarter.

Highlight is at or above NMWQCC Standard.

Highlight is at or above August 2020 existing conditions value. Applicable to samples collected in or after August 2020.

FIGURES

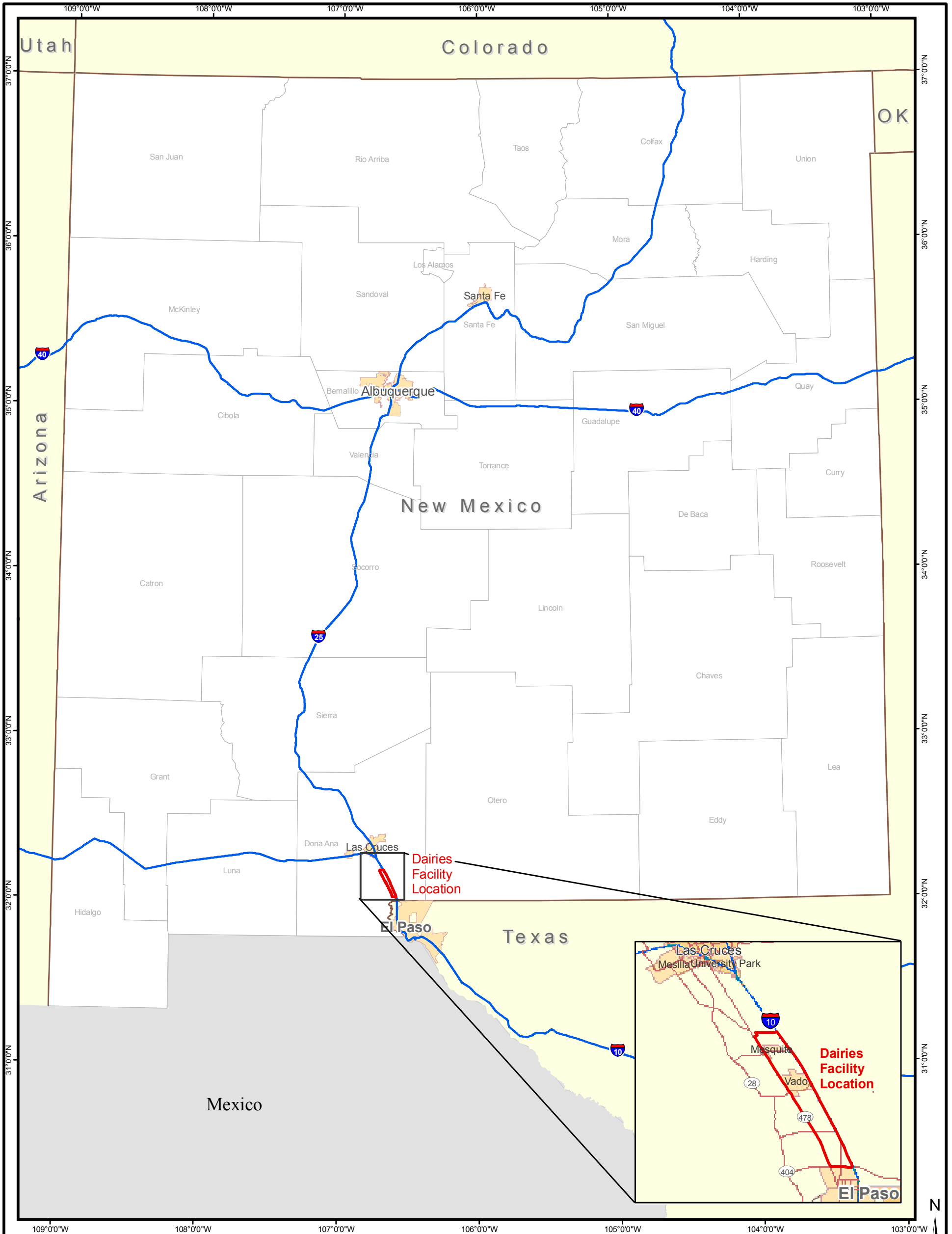

LEGEND:

 Facility Boundary

REFERENCES

Base Data: ESRI, 2008.

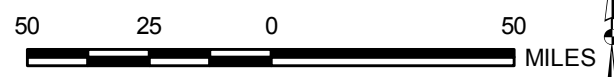

SCALE 1:2,500,000
WHEN PRODUCED AT 11X17IN

PROJECT		DOÑA ANA DAIRIES MESQUITE, NEW MEXICO	
TITLE		SITE LOCATION MAP	
	PROJECT No.	11x17_siteloc.mxd	
	DESIGN		SCALE AS SHOWN
	GIS		REV 0
	CHECK		
REVIEW			
			FIGURE 1

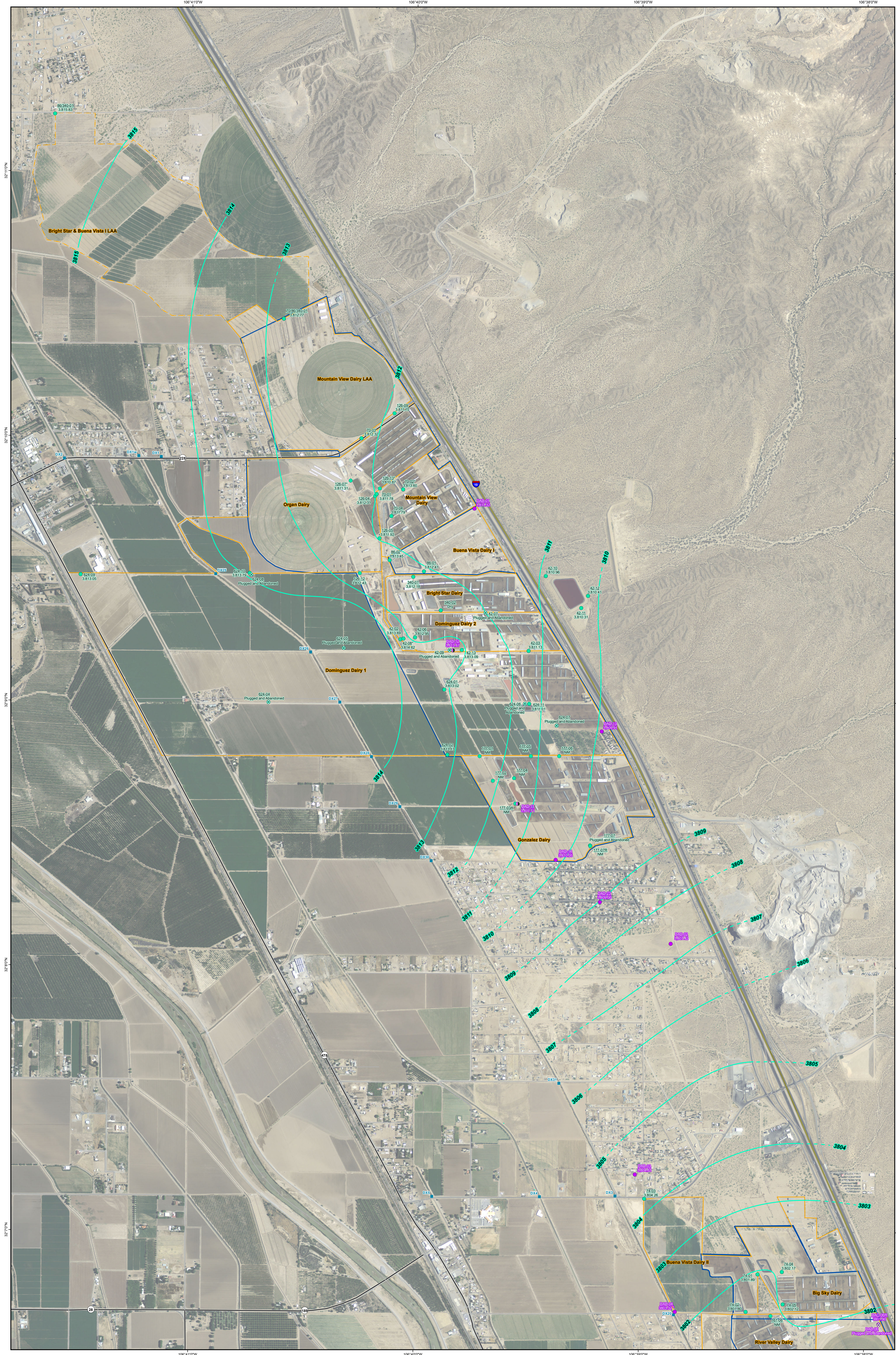

- LEGEND**
- Discharge Plan Well With Water Elevations (Feet MSL)
 - Abatement Plan Well With Water Elevations (Feet MSL)
 - Abatement Plan Vertical Delineation
 - Monitoring Well with Water Elevation (Feet MSL)
 - ⊗ AP P&A
 - ⊗ DP Destroyed, Discharge Plan Well with Water Elevations (Feet MSL)
 - Drain Crossing Location
 - Potentiometric Contour
 - - - Potentiometric Contour - Assumed
 - Interstate Highway
 - State Highway
 - Other Road
 - Land Owned by Dairies
 - Land Application on Non-Dairy Property
 - Stage 2 Abatement Plan Area

Note(s):
 * Well not used in contouring
 Feet MSL = Feet above mean sea level
 NM = Not measured

REFERENCES
 Roads: Doña Ana County, 2001
 Aerial Photography: NADP, 2011
 FIPS: 844, 2000
 Projection: State Plane NAD 83 New Mexico Central (feet)

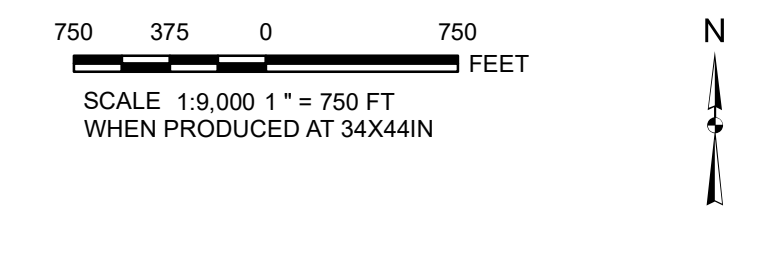

PROJECT		DOÑA ANA DAIRIES MESQUITE, NEW MEXICO	
DATE		POTENTIOMETRIC SURFACE MAP, MAY 2023, NORTHERN PORTION	
PROJECT NO.	DATE	SCALE	FIGURE NO.

2023-07-25 Y:\gis2\Commercial\Doña Ana Dairies - 14641102 May 2023\Projects\Fig 4 SouthRegionAq_Pot_2023_05.mxd EA-Albuquerque escarplo

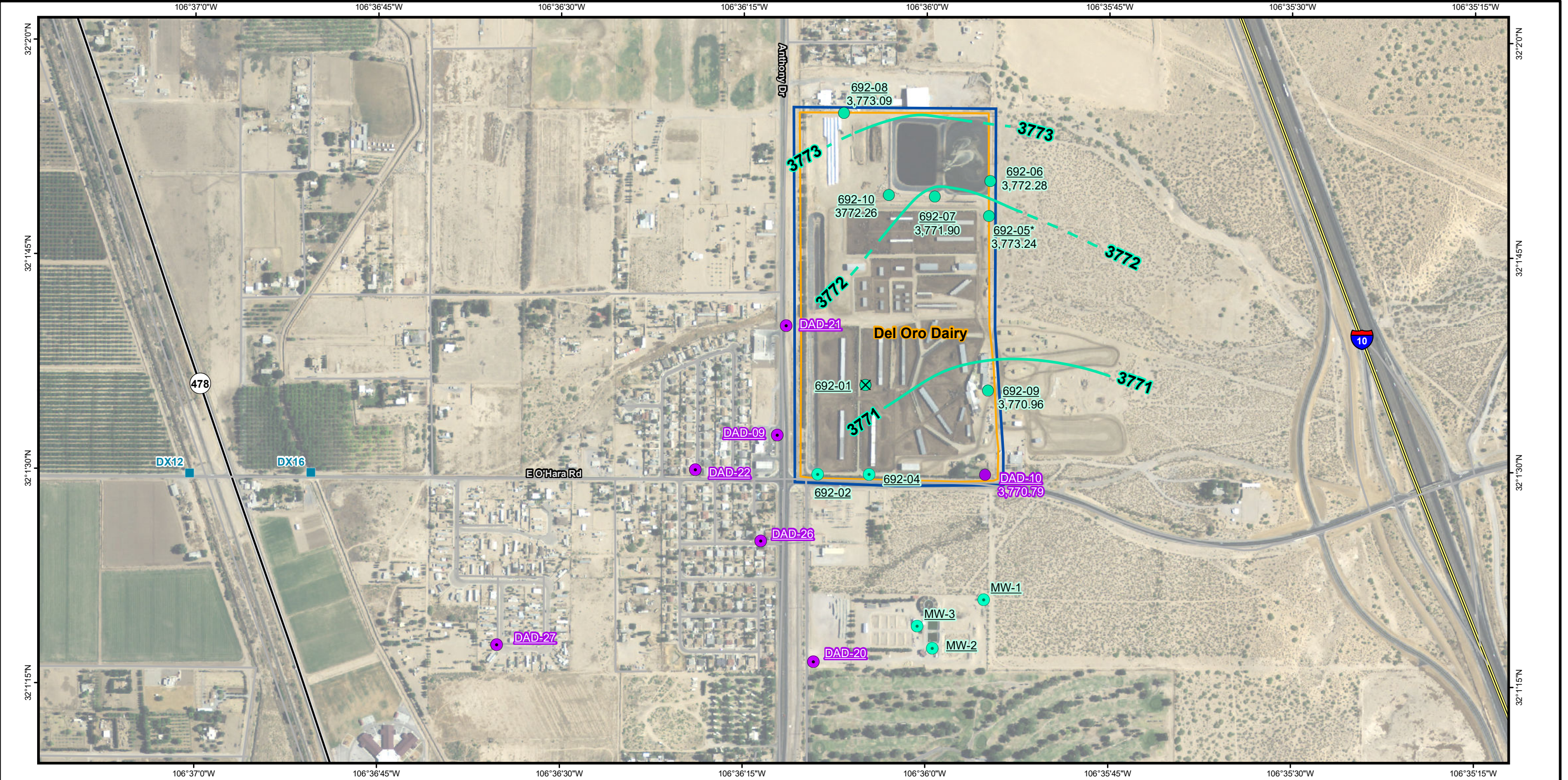

LEGEND:

- Drain Crossing Location
- Perched Aquifer Monitoring Well**
- Abatement Plan Well
- Discharge Plan Well
- ⊗ Discharge Plan Well - Plugged and Abandoned
- Regional Aquifer Monitoring Well**
- Abatement Plan Well With Water Elevations (Feet Above Mean Sea Level)
- Discharge Plan Well with Water Elevation (Feet Above Mean Sea Level)
- Potentiometric Contour
- - - Potentiometric Contour - Assumed
- Land Owned by Dairies
- Stage 2 Abatement Plan Area

* Well not used in contouring

REFERENCES
 Aerial Photography: NAIP, 2011
 PLSS: BLM, 2000
 Projection: State Plane NAD 83 New Mexico Central (feet)

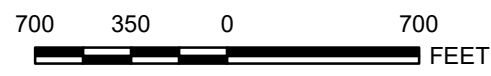

SCALE 1:8,400 1" = 700 FT
 WHEN PRODUCED AT 11X17IN



DOÑA ANA DAIRIES MESQUITE, NEW MEXICO			
POTENTIOMETRIC SURFACE MAP MAY 2023, SOUTHERN PORTION REGIONAL AQUIFER			
	PROJECT No. 21464112.02		Fig 4 SouthRegionAq_Pot.mxd
	DESIGN	NA	SCALE AS SHOWN
	GIS	RMM,EC	REV 0
	CHECK	CL	
	REVIEW	TM	
			FIGURE 4

2023-08-23 \\ABO\Projects\gis2\Commercial\Dona Ana Dairies - 1464110\02 May 2023\Projects\Fig 5 SouthPerchAq_Pot_2023_05.mxd EA-Albuquerque rmullen

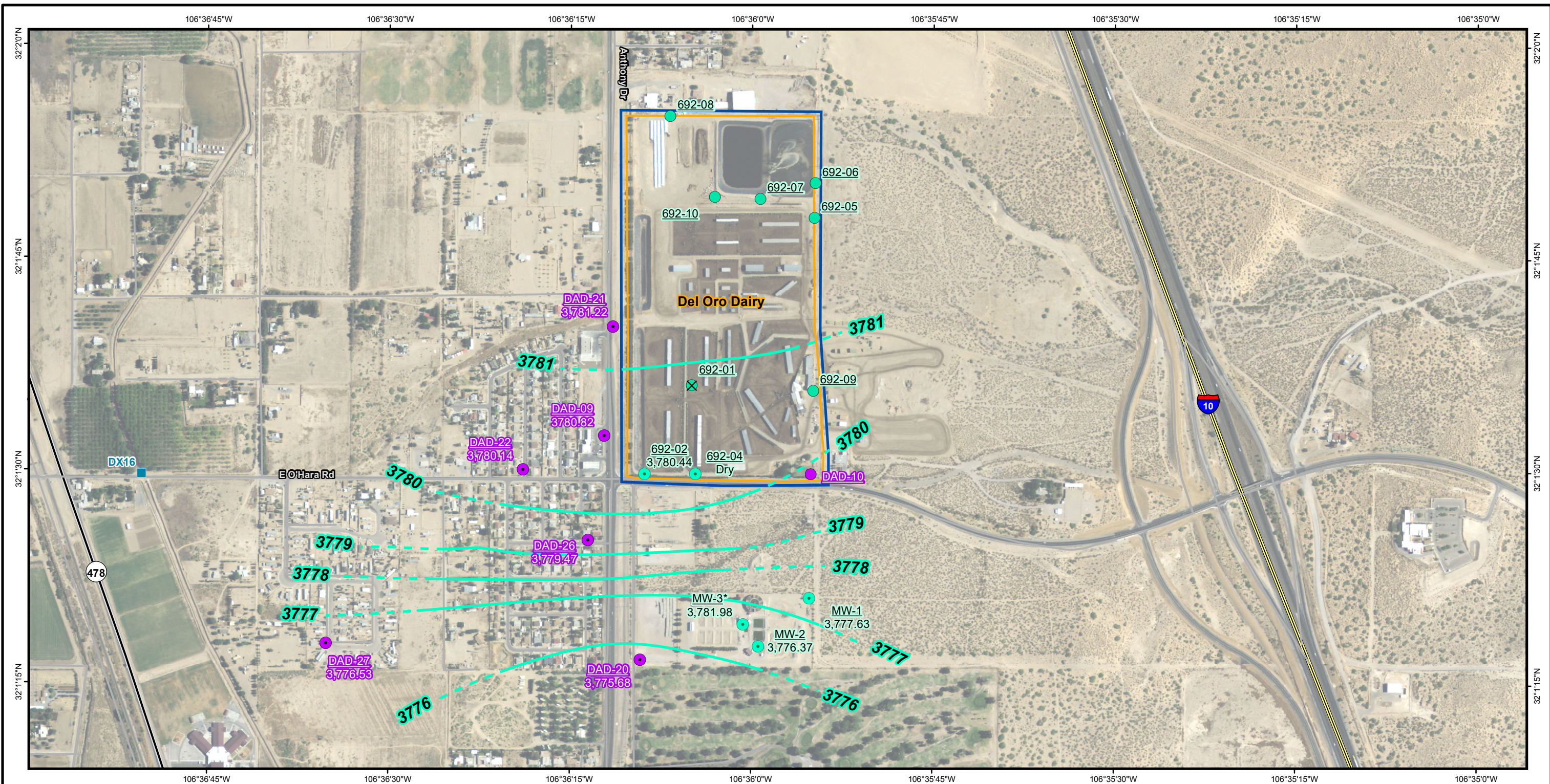

LEGEND:

- Drain Crossing Location
- Perched Aquifer Monitoring Well**
 - Abatement Plan Well With Water Elevations (Feet Above Mean Sea Level)
 - Discharge Plan Well with Water Elevation (Feet Above Mean Sea Level)
 - ✕ Discharge Plan Well - Plugged and Abandoned
- Regional Aquifer Monitoring Well**
 - Abatement Plan Well
 - Discharge Plan Well
- Potentiometric Contour
- - - Potentiometric Contour - Assumed
- Land Owned by Dairies
- Stage 2 Abatement Plan Area

Note:
* = Not used in contouring.

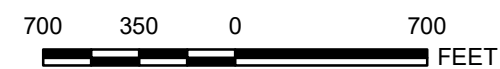

SCALE 1:8,400 1" = 700 FT
WHEN PRODUCED AT 11X17IN



REFERENCES

Aerial Photography: NAIP, 2011
PLSS: BLM, 2000
Projection: State Plane NAD 83 New Mexico Central (feet)

DOÑA ANA DAIRIES MESQUITE, NEW MEXICO			
POTENTIOMETRIC SURFACE MAP MAY 2023, SOUTHERN PORTION PERCHED AQUIFER			
	PROJECT No. 21464112.02		SCALE AS SHOWN
	DESIGN	NA	REV 0
	GIS	RMM, EC	
	CHECK	CL	
REVIEW	TM		FIGURE 5

106°41'0"W

106°40'0"W

106°39'0"W

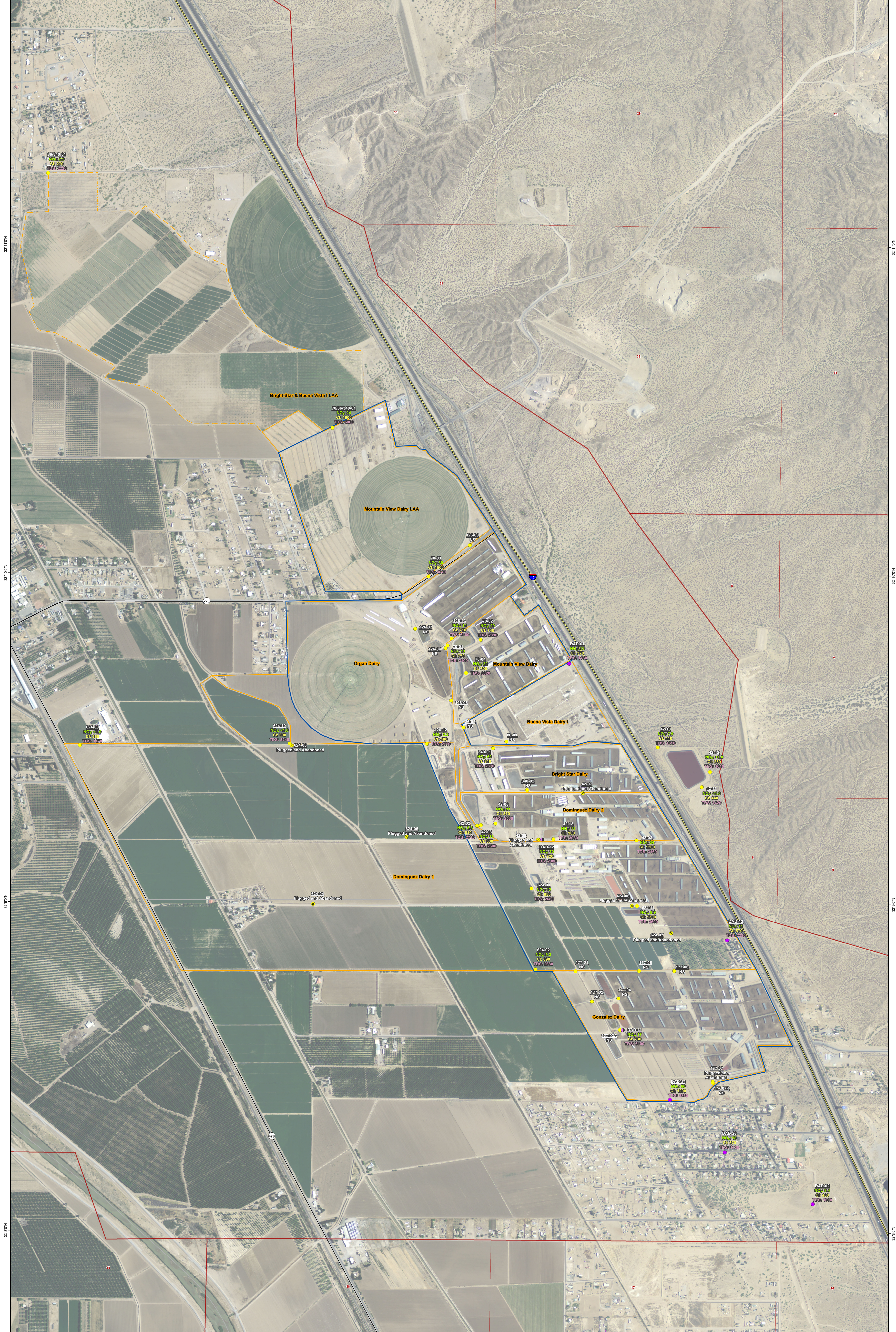

- LEGEND:**
- Abatement Plan Monitoring Well
 - Discharge Plan Monitoring Well
 - Discharge Plan Monitoring Well, Plugged and Abandoned or Destroyed
 - Abatement Plan Vertical Delineation Monitoring Well
 - Interstate Highway
 - State Highway
 - Other Road
 - ▭ Land Owned by Dairies
 - ▭ Land Application on Non-Dairy Property
 - ▭ Stage 2 Abatement Plan Area

Notes:
 Units are in milligrams per liter.
 CI = Chloride
 LRG = Irrigation well
 NO₃ = Nitrate as N
 NS = Not Sampled
 TDS = Total Dissolved Solids

REFERENCES
 Roads: Dona Ana County, 2001
 Aerial Photography: NAIP, 2011
 FIPS: BLM, 2000
 Projection: State Plane NAD 83 New Mexico Central (feet)

0 300 0 600 FEET
 SCALE: 1:7,200 1" = 600 FT
 WHEN PRODUCED AT 34x44IN

**DOÑA ANA DAIRIES
 MESQUITE, NEW MEXICO**

**GROUNDWATER ANALYTICAL RESULTS
 MAY/JUNE 2023
 NORTHERN PORTION**

DATE	NOV 2023	SCALE	AS SHOWN	REV	1
DRAWN	EA				
CHECK	EA				
APPROVED	EA				

FIGURE 6

106°41'0"W

106°40'0"W

106°39'0"W

32°10'N

32°10'N

32°10'N

32°10'N

32°10'N

32°10'N

32°10'N

32°10'N

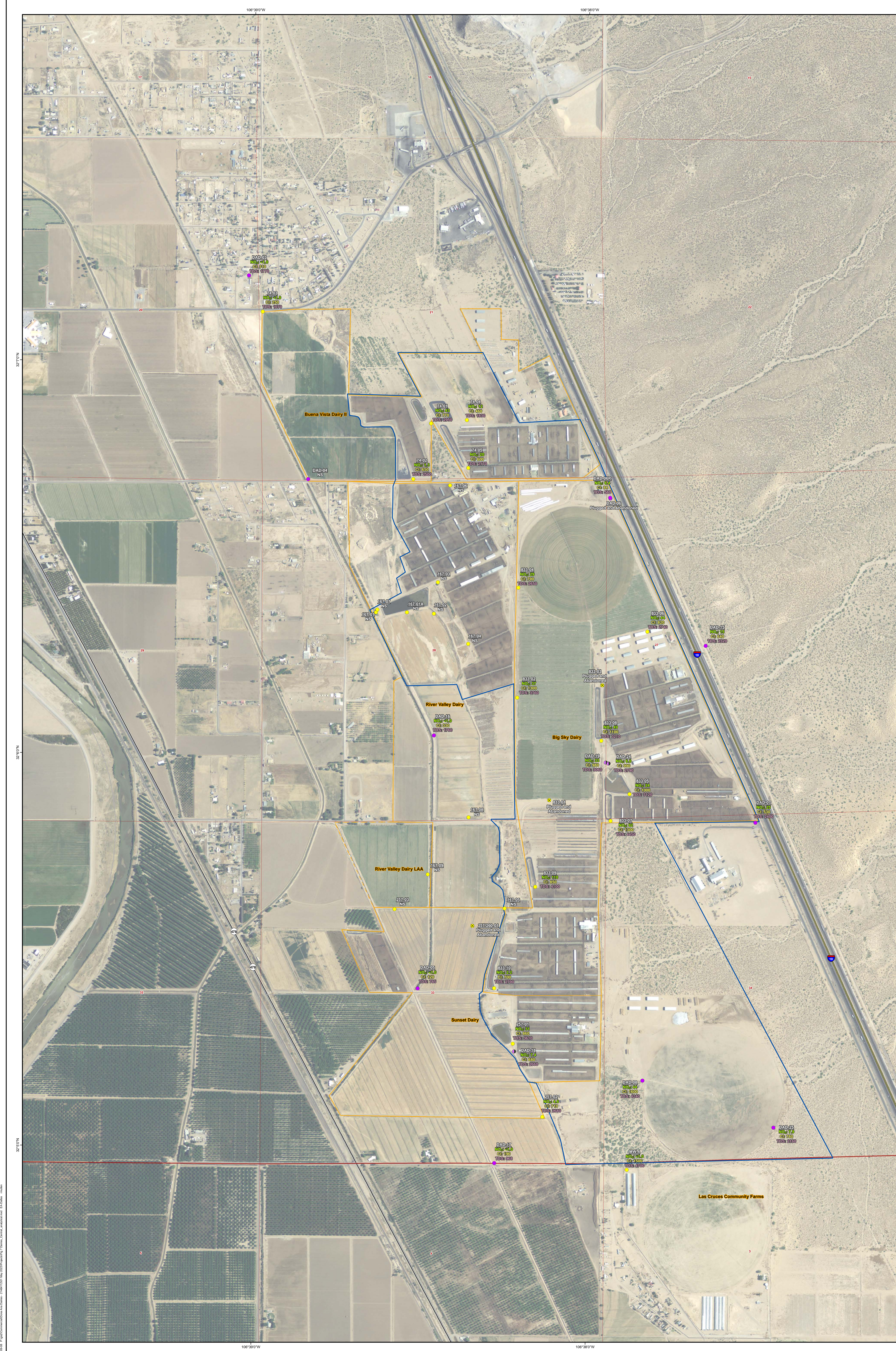

- LEGEND:**
- Abatement Plan Monitoring Well
 - Abatement Plan Monitoring Well, Plugged and Abandoned
 - Discharge Plan Monitoring Well, Plugged and Abandoned
 - Abatement Plan Vertical Delineation Monitoring Well
 - Interstate Highway
 - State Highway
 - Other Road
 - Land Owned by Dairies
 - Land Application on Non-Dairy Property
 - Stage 2 Abatement Plan Area

Notes:
 Units are in milligrams per liter.
 Cl = Chloride
 LRG = Irrigation Well
 NO₃ = Nitrate as N
 NS = Not Sampled
 TDS = Total Dissolved Solids

REFERENCES
 Roads: Doña Ana County, 2011
 Aerial Photography: NAIP, 2011
 PLSS: BLM, 2000
 Projection: State Plane NAD 83 New Mexico Central (feet)

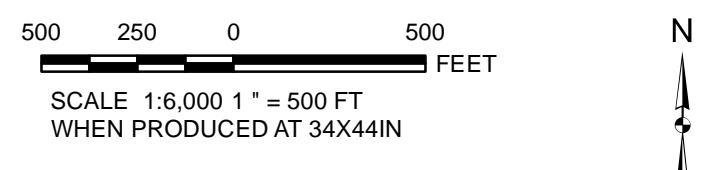

PROJECT		DOÑA ANA DAIRIES MESQUITE, NEW MEXICO	
THE GROUNDWATER ANALYTICAL RESULTS MAY/JUNE/JULY 2023 CENTRAL PORTION			
DATE	BY	REVISED	BY

FIGURE 7

2023 08 08 10:08 AM P:\GIS\Projects\Groundwater\MapDocs\MapDocs_20230808_100808.mxd

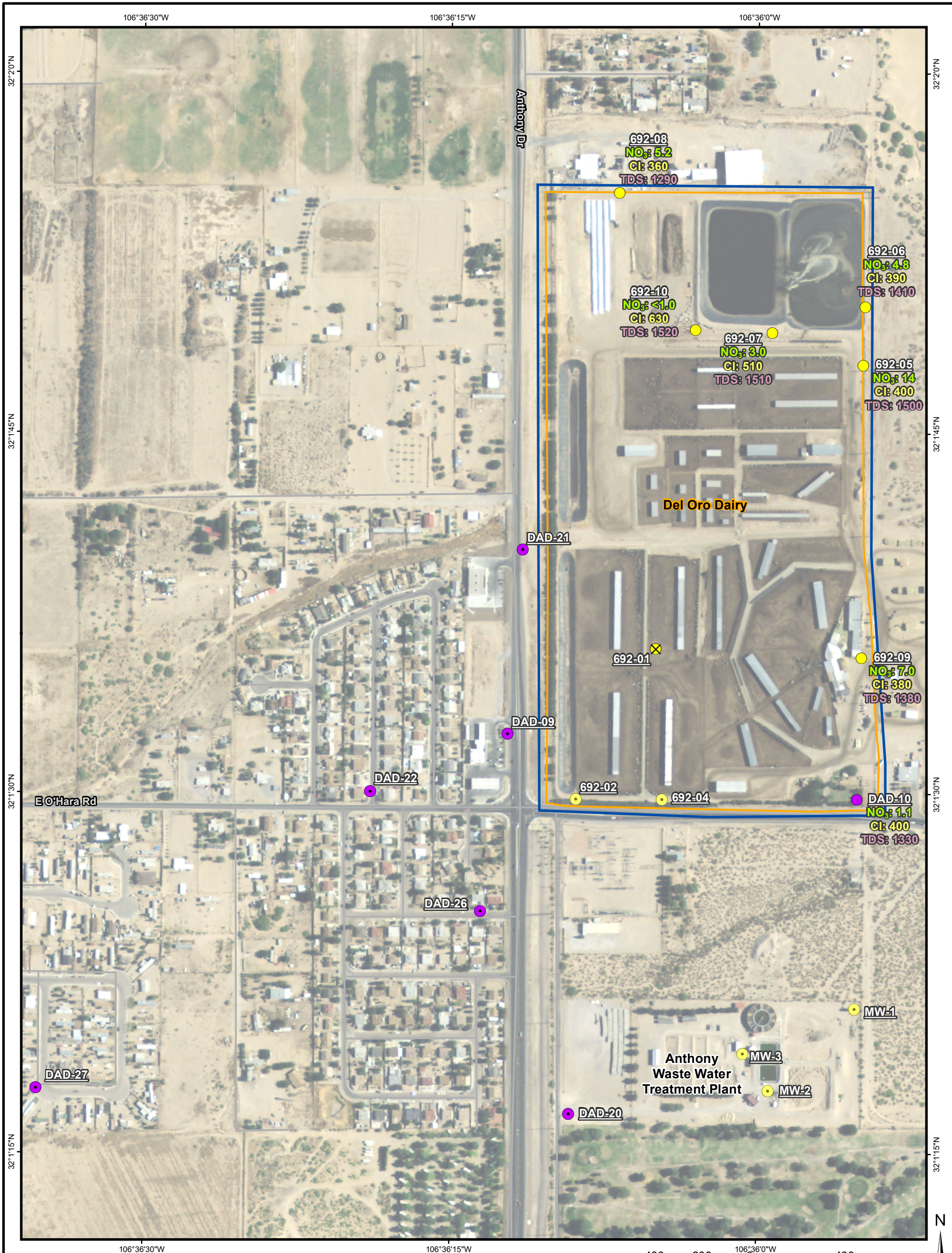

LEGEND :

- Perched Aquifer Monitoring Well**
- Abatement Plan Monitoring Well
 - Discharge Plan Monitoring Well
 - ✕ Discharge Plan Monitoring Well - Plugged and Abandoned
- Regional Aquifer Monitoring Well**
- Abatement Plan Monitoring Well
 - Discharge Plan Monitoring Well
- Land Owned by Dairies
 - Stage 2 Abatement Plan Area

Notes:
 Units are in milligrams per liter.
 * Result represents a composite sample from a water tank supplied by wells LRG-5820, LRG-5820-S, and LRG-5820-S-2.

Cl = Chloride
 LRG = irrigation well
 NO₃ = Nitrate as N
 TDS = Total Dissolved Solids

REFERENCES
 Aerial Photography: NAIP, 2011
 PLSS: BLM, 2000
 Projection: State Plane NAD 83 New Mexico Central (feet)

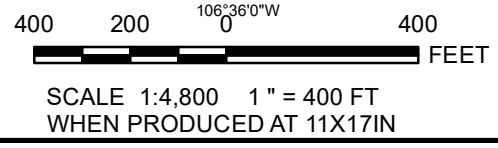

PROJECT			
DOÑA ANA DAIRIES MESQUITE, NEW MEXICO			
TITLE			
GROUNDWATER ANALYTICAL RESULTS MAY/JUNE 2023 SOUTHERN PORTION, REGIONAL AQUIFER			
	PROJECT No. 21464112.02	SCALE AS SHOWN	
	DESIGN NA	REV 0	
	GIS RM		
	CHECK		
REVIEW			FIGURE 8

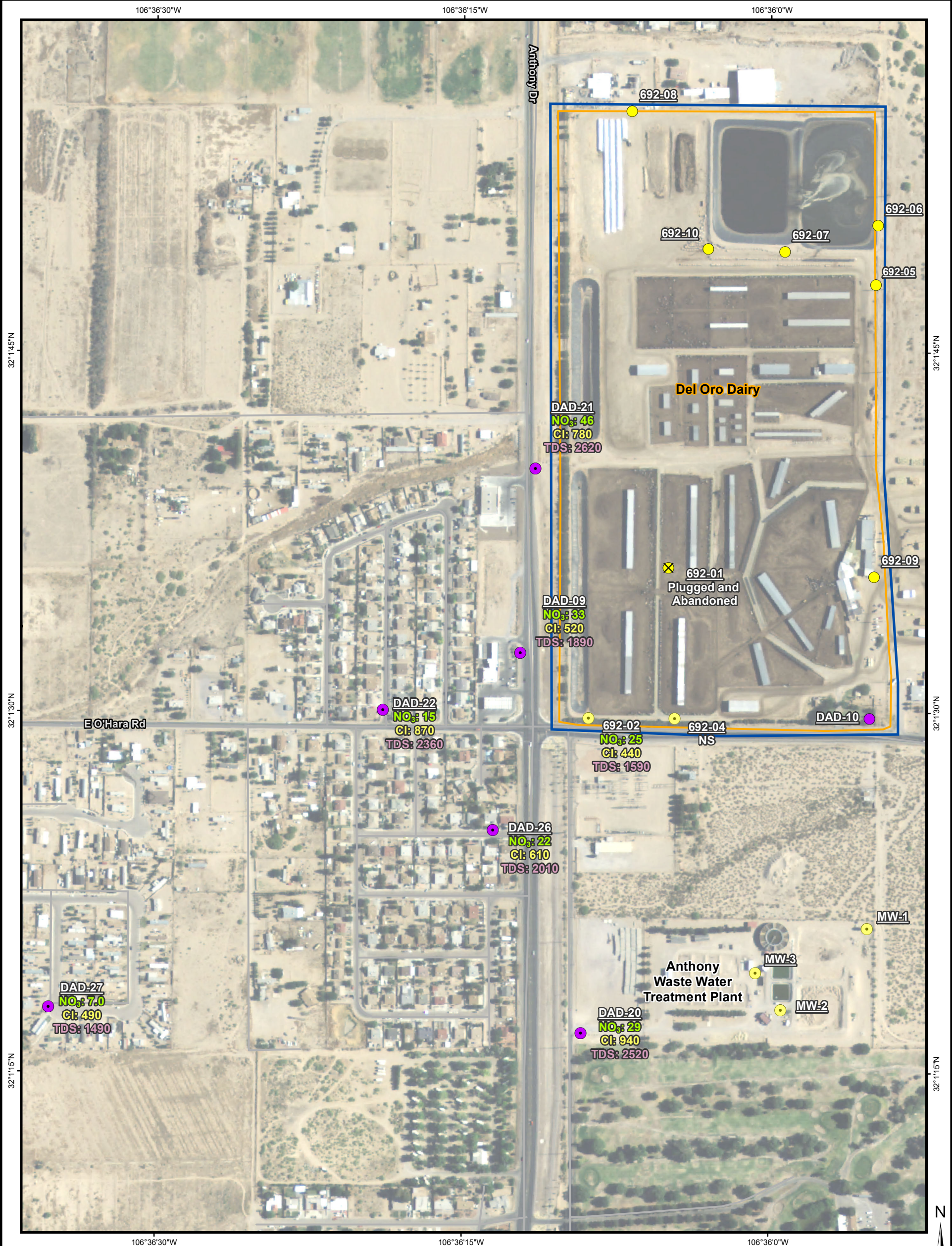

LEGEND:

- Perched Aquifer Monitoring Well**
 - Abatement Plan Monitoring Well
 - Discharge Plan Monitoring Well
 - ⊗ Discharge Plan Monitoring Well - Plugged and Abandoned
- Regional Aquifer Monitoring Well**
 - Abatement Plan Monitoring Well
 - Discharge Plan Monitoring Well
- ▭ Land Owned by Dairies
- ▭ Stage 2 Abatement Plan Area

Notes:
 Units are in milligrams per liter.
 Cl = Chloride
 LRG = irrigation well
 mg/L = Milligram(s) per liter
 NO₃ = Nitrate as N
 NS = Not sampled
 TDS = Total Dissolved Solids

REFERENCES
 Aerial Photography: NAIP, 2011
 PLSS: BLM, 2000
 Projection: State Plane NAD 83 New Mexico Central (feet)

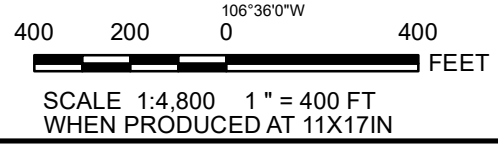

PROJECT				
DOÑA ANA DAIRIES MESQUITE, NEW MEXICO				
TITLE				
GROUNDWATER ANALYTICAL RESULTS MAY/JUNE 2023 SOUTHERN PORTION, PERCHED AQUIFER				
	PROJECT No. 21464112.02		FIGURE 9	
	DESIGN	NA		SCALE AS SHOWN
	GIS	RM		REV 0
	CHECK			
REVIEW				

APPENDIX A

**DEL ORO DAIRY PUMP AND REUSE SYSTEM PERFORMANCE
ASSESSMENT**

DEL ORO DAIRY PUMP AND REUSE SYSTEM PERFORMANCE ASSESSMENT

This quarterly performance assessment of the Del Oro Pump and Reuse System has been prepared in compliance with the Stage 2 Abatement Plan (S2AP) Modification Performance Plan (EA Engineering, Science, and Technology, Inc., PBC [EA] 2022). Note that references are included in the main document text.

The performance assessment evaluates pumping rates, total volume pumped, mass removed, and plume capture by the five extraction wells installed along the downgradient perimeter of the Del Oro Dairy property. A site background summary is included in the main report.

Pump and Reuse System

The pump and reuse system is shown in plan view on Figure 1. The system consists of:

- Five, 4-inch diameter groundwater extraction wells completed in the perched aquifer. The submerged screen was installed at 14 to 15 feet below ground surface, representing the perched aquifer thickness (water table to confining clay).
- Five submersible solar groundwater pumps supplied by Rural Pumping Systems, complete with controllers and 4 x 100-Watt (400 Watt total) solar panels installed at each well head.
- Well head completions consisting of valves, flow meters, sample ports, and steel pipe fence and bollards to isolate from cattle.
- Main conveyance line consisting of 1.5-inch diameter high density polyethylene (HDPE) pipe connecting the extraction wells to HDPE storage tanks located at the milking parlor.
- Two 6,000 HDPE storage tanks plumbed in parallel.
- Transfer pump and pressure tank for delivery to the milking parlor.

A process flow diagram of the system is provided as Drawing P-1.

Quarterly Performance Assessment

Startup testing began in late December 2022 following pump and solar panel installation. After several iterations of trouble-shooting, all pumps were pumping at capacity by April 2023 except for extraction well EW-3. Low permeability at well EW-3 has prevented extraction of water at this location. Its omission from the well network is not expected to negatively impact system efficacy. Del Oro Dairy performs weekly meter reading and relays data to EA for record keeping and reporting.

Performance assessment will be used to evaluate average pumping rates, mass removal of nitrate, and plume capture by the five extraction wells. The performance assessment consists of three components: 1) tracking and reporting of extracted groundwater volume, 2) collection of groundwater samples from extraction wells and analysis of mass removal, and 3) capture analysis.

Extracted Groundwater Volume

Totalizing flow meters measure the volume of extracted groundwater from each extraction well as reported in Table 1. The aggregate volume of water pumped from the five wells is also measured at the storage tanks with a totalizing meter located just before outfall into the storage tanks. Weekly liquid depth measurements for the Del Oro lagoon cells (ultimate destination of extraction water) are provided in Attachment 1.

Groundwater Sampling and Mass Removal

Groundwater samples are collected from each extraction well quarterly on the abatement plan monitoring schedule. Analytical results for samples collected in May 2023 are provided in Table 2 and laboratory reports are provided in Attachment 2.

Nitrate mass removal rates are the product of flow rate and chemical concentrations, which yield total mass removed per quarter. Mass removal is summarized in Table 3. The nitrate mass removed this quarter was 276 pounds. Cumulative mass removed since startup is 419 pounds.

Capture Analysis

Capture analysis is a function of flow rate, permeability (hydraulic conductivity), and hydraulic gradient. Flow rates are measured weekly via flow meters, and hydraulic gradient is calculated from quarterly water level measurements. Hydraulic conductivity for the perched aquifer was estimated based on observed grain size and typical values. For fine to medium sand, 10^{-2} to 10^{-3} centimeters per second (cm/s) is typical, and this range equates to 27 to 2.7 feet per day (ft/day). Since the sand was logged as “poorly graded fine sand,” permeability was assigned as 10 ft/day in higher yielding wells EW-1, EW-2, EW-4 and EW-5, and 1 ft/day for low yielding well EW-3. Based on these permeabilities and measured flow rates and gradient, the estimated capture width for each well is provided in Table 4. Concentration trends for downgradient and key monitoring wells is provided in Attachment 3.

Attachments: Figure 1 – Extraction System Layout
Drawing P-1 –Process Flow Diagram
Table 1 – Pumping Volume and Rates
Table 2 – Extraction Well Groundwater Analytical Results
Table 3 – Summary of Nitrate Mass Removal
Table 4 – Capture Analysis for Pumping Wells
Attachment 1 – Weekly Liquid Depth Measurements for Lagoons
Attachment 2 – Analytical Chemistry Report
Attachment 3 – Concentration Trends for Downgradient and Key Monitoring Wells

FIGURE 1 and DRAWING P-1

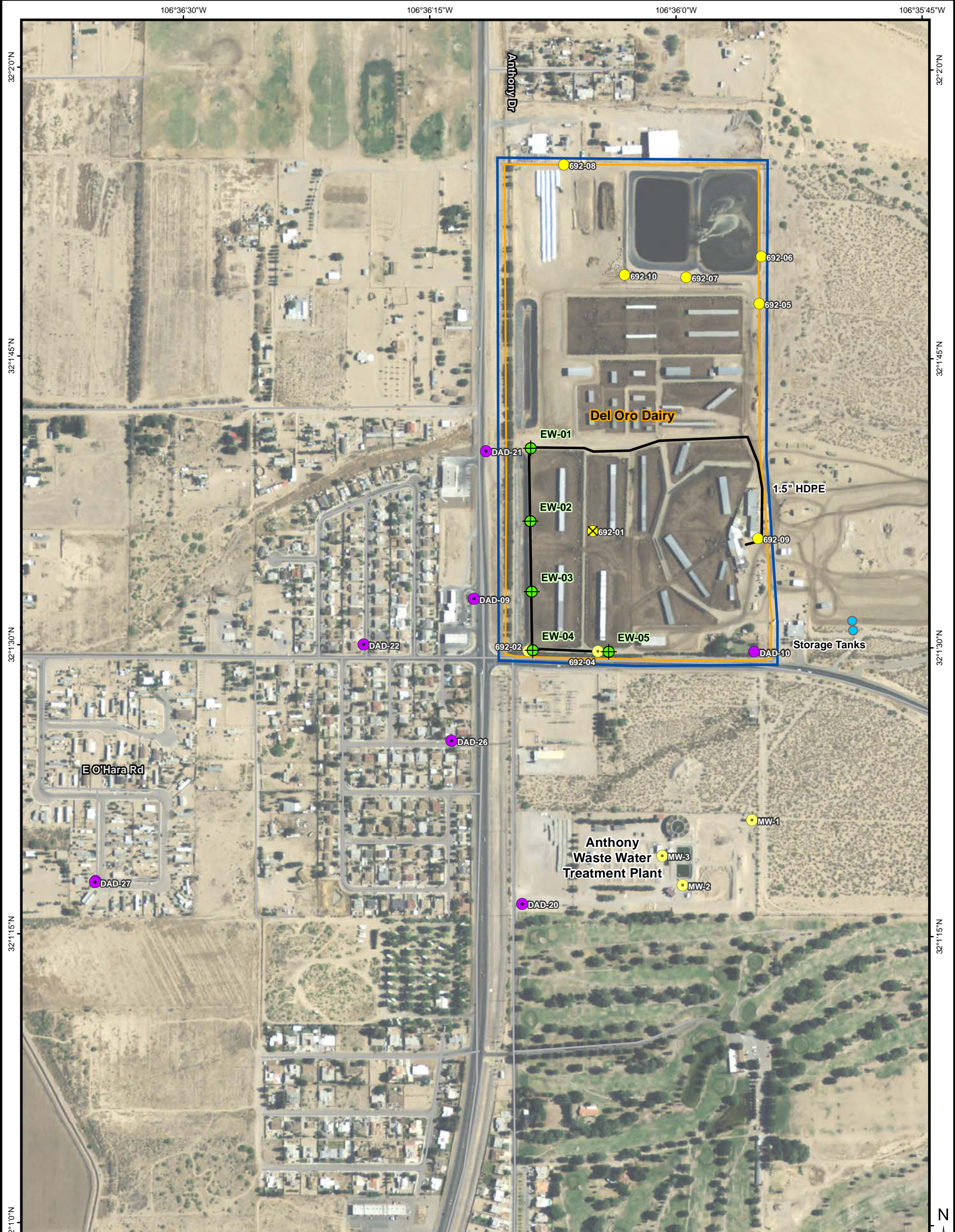

LEGEND:

- Extraction Well
- Conveyance Line
- Perched Aquifer Monitoring Well**
 - Abatement Plan Monitoring Well
 - Discharge Plan Monitoring Well
 - Discharge Plan Monitoring Well - Plugged and Abandoned
- Regional Aquifer Monitoring Well**
 - Abatement Plan Monitoring Well
 - Discharge Plan Monitoring Well
- Land Owned by Dairies
- Stage 2 Abatement Plan Area

REFERENCES
 Aerial Photography: NAIP, 2011
 PLSS: BLM, 2000
 Projection: State Plane NAD 83 New Mexico Central (feet)

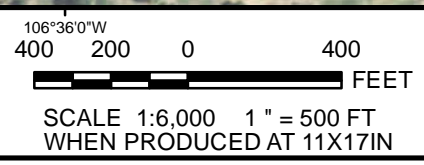

PROJECT		DOÑA ANA DAIRIES MESQUITE, NEW MEXICO	
TITLE		EXTRACTION SYSTEM LAYOUT DEL ORO DAIRY	
	PROJECT No. 1464109.04	SCALE AS SHOWN	REV 0
	DESIGN NA		
	GIS RM		
	CHECK		
REVIEW			
			FIGURE 1

P:\Active Projects\Documents\Del Oro\Figures
 Vener Mustafin 2/10/23 10:46 AM C:\Users\vmustafin\OneDrive - EA Engineering, Science, and Technology, Inc.\PBC\Documents\Work\Domestic\Del Oro.dwg

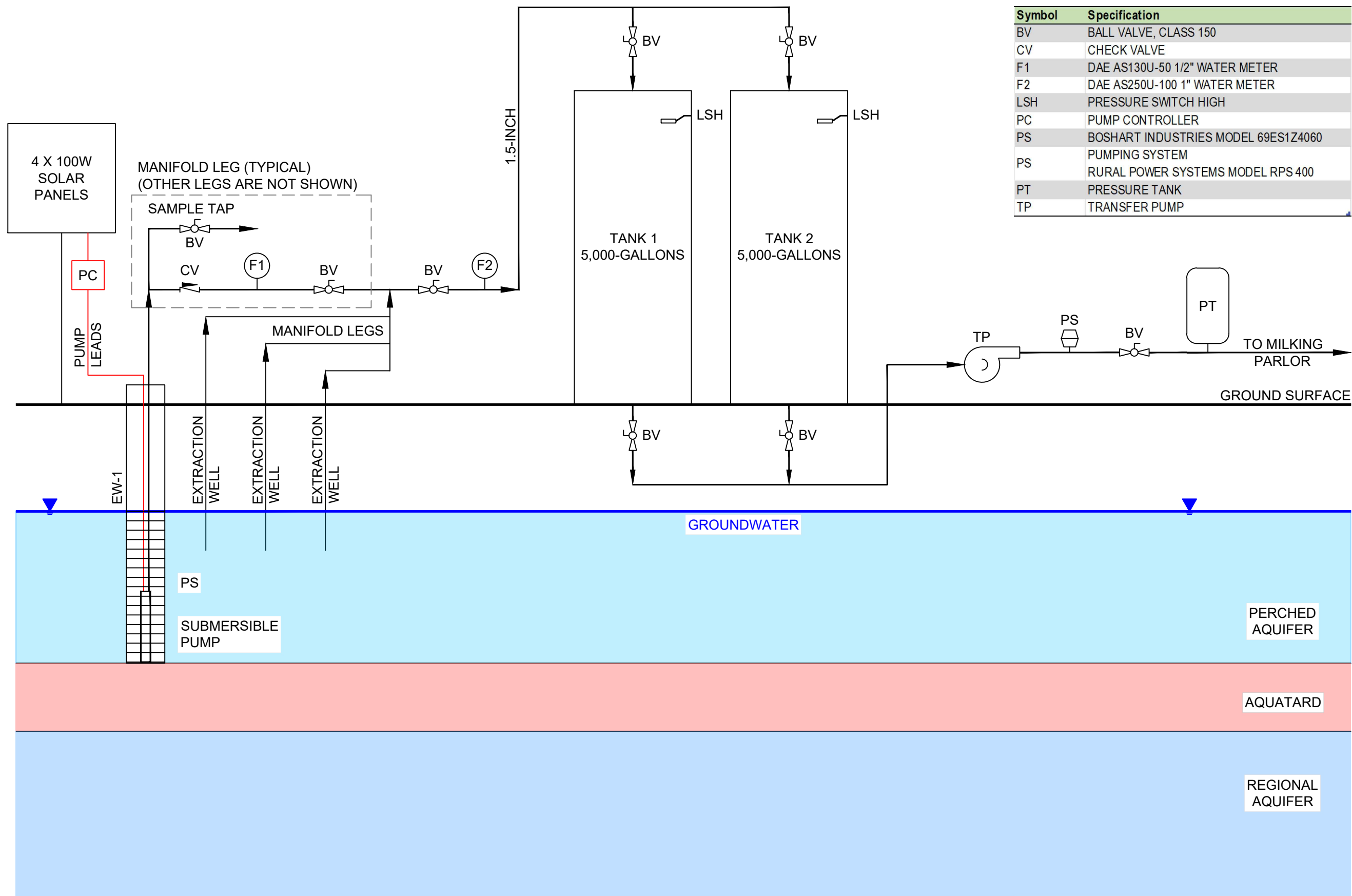

Symbol	Specification
BV	BALL VALVE, CLASS 150
CV	CHECK VALVE
F1	DAE AS130U-50 1/2" WATER METER
F2	DAE AS250U-100 1" WATER METER
LSH	PRESSURE SWITCH HIGH
PC	PUMP CONTROLLER
PS	BOSHART INDUSTRIES MODEL 69ES1Z4060
PS	PUMPING SYSTEM
PS	RURAL POWER SYSTEMS MODEL RPS 400
PT	PRESSURE TANK
TP	TRANSFER PUMP

REV	DATE	DRAWN	CHECKED	REMARKS
0	2/10/23			
	2/10/23			

DESIGNED BY: JS
 DRAWN BY: VM
 CHECKED BY: JS

DE LO RO DAIRY, ANTHONY, NEW MEXICO
 STAGE 2 ABATEMENT PLAN MODIFICATION

EA ENGINEERING, SCIENCE, AND TECHNOLOGY, INC.
 320 GOLD AVENUE, SUITE 1000
 ALBUQUERQUE, NM, 87102
 505-224-9013, HTTPS://EAST.COM

PROJECT NUMBER:
 1464110-01

DRAWING NO.:
P-1

ATTACHMENTS

**ATTACHMENT 1 – WEEKLY LIQUID DEPTH MEASUREMENTS FOR
LAGOONS**

**CAFO Weekly Storage and Containment Structure Inspections
Log Sheet**

Facility Name: Del Oro Dairy

NPDES Permit No.: NMG010026

Storage or Containment Structure: Evaporative Pond ^A (Instructions on back)

Week	Date	Initials	Depth Marker Reading	Notes	Date Corrected
Week 1	1-3-23	ER	9-		
Week 2	1-10-23	ER	9-		
Week 3	1-17-23	ER	9-		
Week 4	1-24-23	ER	9-		
Week 5	1-31-23	ER	9-		
Week 6	2-7-23	ER	9-		
Week 7	2-14-23	ER	9-		
Week 8	2-21-23	ER	9-		
Week 9	2-28-23	ER	9-		
Week 10	3-7-23	ER	9-		
Week 11	3-14-23	ER	9-		
Week 12	3-21-23	ER	9-		
Week 13	3-28-23	ER	9-		
Week 14	4-4-23	ER	9-		
Week 15	4-11-23	ER	9-		
Week 16	4-18-23	ER	9-		
Week 17	4-25-23	ER	9-		
Week 18	5-2-23	ER	9-		
Week 19	5-9-23	ER	9-		
Week 20	5-16-23	ER	9-		
Week 21	5-23-23	ER	9-		
Week 22	5-30-23	ER	9-		
Week 23	6-6-23	ER	9-		
Week 24	6-13-23	ER	9-		
Week 25	6-20-23	ER	9-		
Week 26	6-27-23	ER	9-		
Week 27	7-4-23	ER	9-		
Week 28	7-11-23	ER	9-		
Week 29	7-18-23	ER	9-		
Week 30	7-25-23	ER	9-		
Week 31	8-1-23	ER	9-		
Week 32	8-8-23	ER	9-		
Week 33	8-15-23	ER	9-		
Week 34	8-22-23				
Week 35	8-29-23				
Week 36					
Week 37					
Week 38					
Week 39					
Week 40					
Week 41					
Week 42					
Week 43					
Week 44					
Week 45					
Week 46					
Week 47					
Week 48					
Week 49					
Week 50					
Week 51					
Week 52					

**CAFO Weekly Storage and Containment Structure Inspections
Log Sheet**

Facility Name: Del Oro Dairy

NPDES Permit No.: NMG010026

Storage or Containment Structure: Evaporative Pond **B** (Instructions on back)

Week	Date	Initials	Depth Marker Reading	Notes	Date Corrected
Week 1	1-3-23	ER	5-		
Week 2	1-10-23	ER	5-		
Week 3	1-17-23	ER	5-		
Week 4	1-24-23	ER	5-		
Week 5	1-31-23	ER	5-		
Week 6	2-7-23	ER	5-		
Week 7	2-14-23	ER	5-		
Week 8	2-21-23	ER	5-		
Week 9	2-28-23	ER	5-		
Week 10	3-7-23	ER	5-		
Week 11	3-14-23	ER	5-		
Week 12	3-21-23	ER	5-		
Week 13	3-28-23	ER	5-		
Week 14	4-4-23	ER	5-		
Week 15	4-11-23	ER	5-		
Week 16	4-18-23	ER	5-		
Week 17	4-25-23	ER	5-		
Week 18	5-2-23	ER	4 1/2		
Week 19	5-9-23	ER	4 1/2		
Week 20	5-16-23	ER	4 1/2		
Week 21	5-23-23	ER	4 1/2		
Week 22	5-30-23	ER	4-		
Week 23	6-6-23	ER	4-		
Week 24	6-13-23	ER	4-		
Week 25	6-20-23	ER	4-		
Week 26	6-27-23	ER	4-		
Week 27	7-4-23	ER	4-		
Week 28	7-11-23	ER	4-		
Week 29	7-18-23	ER	4-		
Week 30	7-25-23	ER	3 1/2		
Week 31	8-1-23	ER	3 1/2		
Week 32	8-8-23	ER	3 1/2		
Week 33	8-15-23	ER	3 1/2		
Week 34	8-22-23				
Week 35	8-29-23				
Week 36					
Week 37					
Week 38					
Week 39					
Week 40					
Week 41					
Week 42					
Week 43					
Week 44					
Week 45					
Week 46					
Week 47					
Week 48					
Week 49					
Week 50					
Week 51					
Week 52					

ATTACHMENT 2 – ANALYTICAL CHEMISTRY REPORT
(Provided in Electronic Format via CD Located on Front Cover of Report)

**ATTACHMENT 3 – CONCENTRATION TRENDS FOR DOWNGRADIENT
AND KEY MONITORING WELLS**

**NITRATE CONCENTRATION TRENDS
 DEL ORO EXTRACTION WELLS AND ABATEMENT PLAN MONITORING WELLS
 IN THE PERCHED AQUIFER
 DONA ANA DAIRIES, DONA ANA COUNTY, NEW MEXICO**

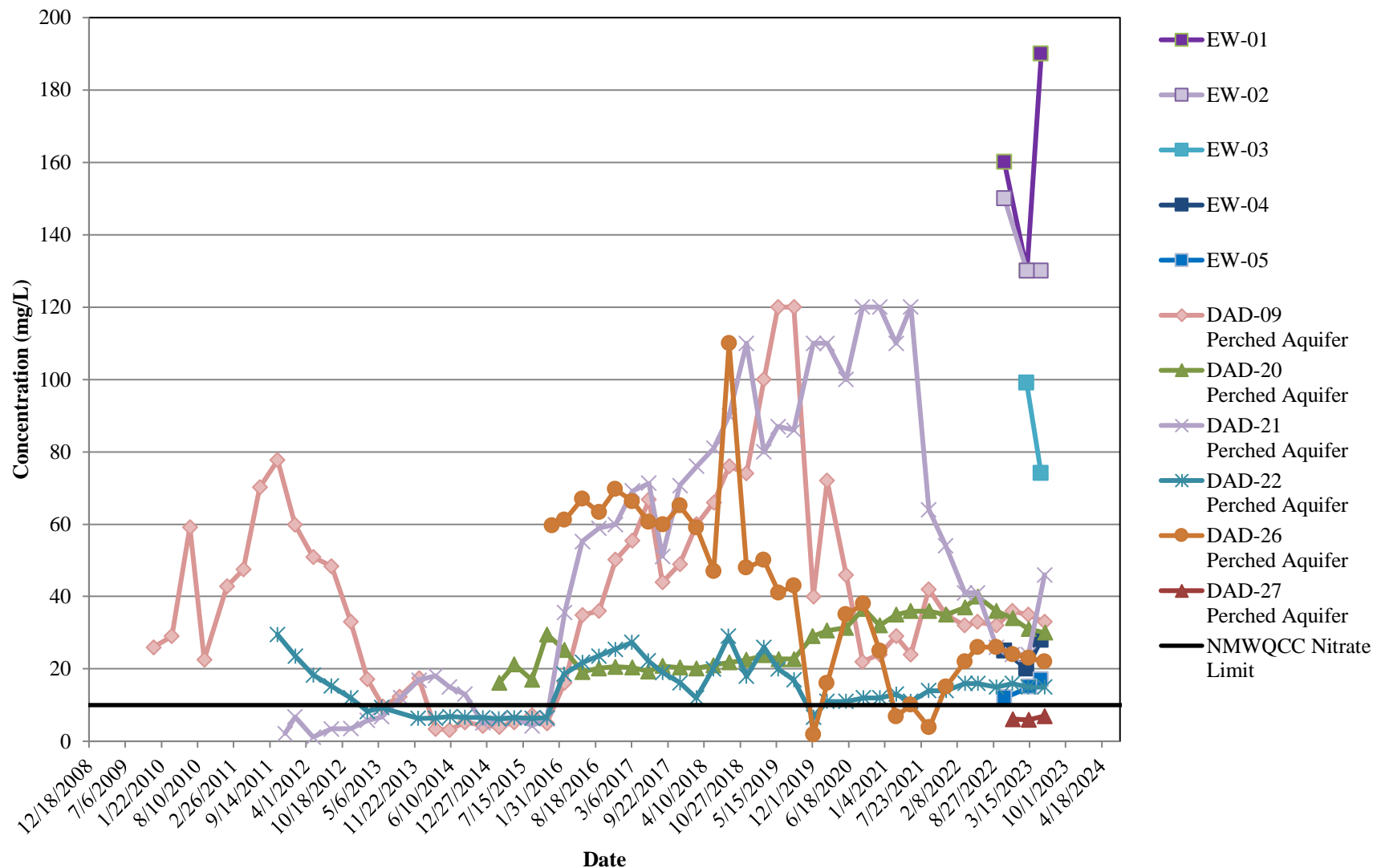

**CHLORIDE CONCENTRATION TRENDS
 DEL ORO EXTRACTION WELLS AND ABATEMENT PLAN MONITORING WELLS
 IN THE PERCHED AQUIFER
 DONA ANA DAIRIES, DONA ANA COUNTY, NEW MEXICO**

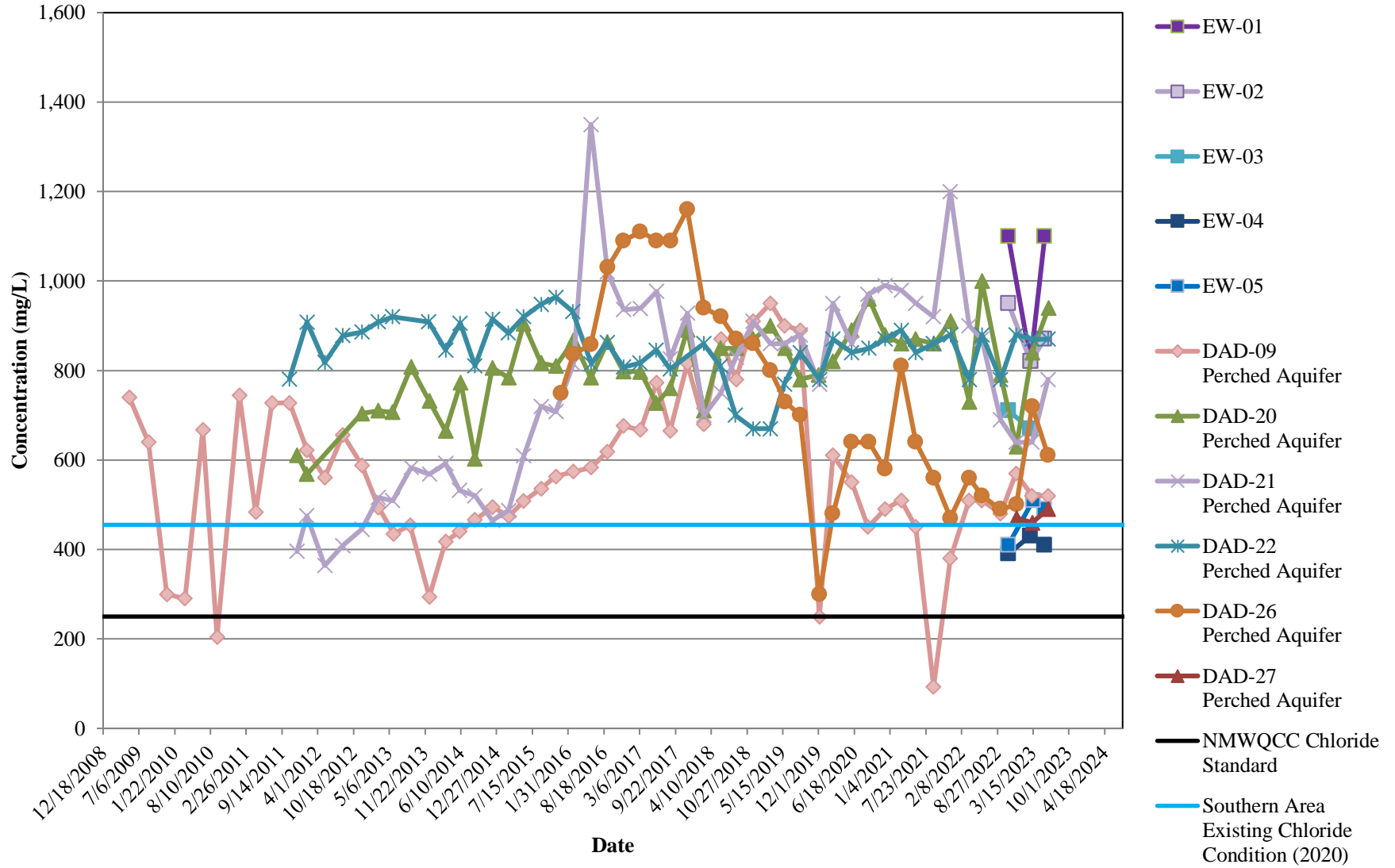

APPENDIX B

GAUGING AND SAMPLING FIELD FORMS

(Provided in Electronic Format via CD Located on Front Cover of Report)

**MONITORING WELL GAUGING DATA
DONA ANA DAIRIES, DONA ANA COUNTY, NEW MEXICO**

Monitoring Well	Northing*	Easting*	Date	Time	Depth to Water	Notes or Total Depth (ft)
NORTHERN AREA						
Northern Land Application Area (DP-340)						
70-03	424580.78	1510233.88	5-1-23	9:51	59.11	61.65
70/86/340-01	427320.92	1508461.05	5-1-23	9:52	54.00	67.93
86/340-01	432021.33	1503216.90	5-1-23	8:53	60.31	70.20
Mountain View Dairy (DP-70)						
70-01	423303.43	1510585.63	5-1-23	10:32	40.06	45.75
70-02	423412.73	1511192.51	5-1-23	10:55	47.65	49.85
70-04	422798.94	1510922.20	5-1-23	11:15	38.02	47.82
Buena Vista Dairy I (DP-86)						
86-01	421534.62	1511667.76	5-1-23	11:38	52.55	54.46
86-02	421792.08	1510881.53	5-1-23	11:55	34.63	48.45
Bright Star Dairy (DP-340)						
340-01	421410.13	1511423.42	5-1-23	13:26	46.30	48.25
340-02	420641.08	1512051.57	5-1-23	13:50	DRY	56.92
Dominguez2 (DP-42)						
42-02	419982.45	1511126.19	5-2-23	9:58	31.00	65.31 Puml
42-03	419710.55	1514064.35	5-2-23	8:57	87.33	97.20 Puml
42-06	420021.61	1511465.15	5-2-23	9:50	37.20	41.53 Puml
X 42-07	420584.8	1513076.66	5-2-23	---	---	WELL REMOVED <i>pump removed</i> Puml
42-08	419994.93	1511197.91	5-2-23	10:07	31.91	35.11 Puml
X 42-09	419729.17	1512255.76	5-2-23	---	---	WELL REMOVED Puml
42-10	421426.39	1514460.4	5-2-23	11:49	118.32	123.63 Puml
42-11	420693.98	1515270.32	5-2-23	10:36	129.00	133.50 Puml
42-12	420972.09	1515423.88	5-2-23	11:08	135.42	139.47 Puml
42-13	419734.06	1512534.42	5-2-23	9:15	60.01	67.60 Puml
Dominguez Dairy (DP-624)						
624-01	418826.21	1512131.46	5-2-23	13:13	30.70	46.81
624-02	417335.25	1512201.42	5-2-23	13:38	22.32	37.40
624-09			5-2-23	14:36	25.20	32.80
624-10			5-1-23	14:52	25.71	37.33
624-11			5-2-23	12:57	56.12	68.07

**MONITORING WELL GAUGING DATA
DONA ANA DAIRIES, DONA ANA COUNTY, NEW MEXICO**

Monitoring Well	Northing	Eastng"	Date	Time	Depth to Water	Notes or Total Depth (ft)
CENTRAL AREA						
Buena Vista Dairy II (DP-74)						
74-01	405434.93	1519310.15	5-3-23	12:53	39.12	45.25
74-02	404574.08	1519035.52	5-3-23	12:59	18.78	20.33
74-03	407163.61	1516711.72	5-3-23	12:47	19.10	20.29
74-04	405488.65	1519864.48	5-3-23	13:08	51.00	57.90
74-05	404747.71	1519885.3	5-3-23	13:20	43.23	57.15
Big Sky Dairy (DP-833)						
833-02	401200.32	1520639.92	5-3-23	14:11	36.40	57.95
833-04	402898.52	1520659.33	5-3-23	13:50	45.05	53.30
833-05	399712.39	1522374.73	5-3-23	14:52	67.57	73.51
833-06	402219.48	1522652.04	5-3-23	13:37	77.25	85.25
833-07	399298.8	1522082.75	5-3-23	14:35	63.03	73.55
833-08	400535.64	1521938.23	5-3-23	14:22	62.92	73.24
833-09	398280.67	1520918.52	5-4-23	9:56	29.03	39.67
833-10	396715.89	1520283.6	5-4-23	10:15	23.51	37.72
Sunset/Desert Land Dairy (DP-257)						
257-01	395856.31	1520572.16	5-4-23	10:59	22.40	25.85
257-02	394728.34	1521030.29	5-4-23	11:20	17.34	20.83
257-03	397935.69	1518746.14	5-4-23	10:29	14.93	16.15
MW-4			5-4-23	12:20	33.30	39.95
Del Oro Dairy (DP-692)						
SOUTHERN AREA						
692-02	372984.72	1531192.1	5-4-23	15:13	60.40	66.15
692-04	372982.53	1531555.21	5-4-23	15:03	Dry	60.58
692-05	374807.26	1532403	5-4-23	15:26	81.02	87.50
692-06	375054.77	1532411.83	5-4-23	15:34	84.20	90.21
692-07	374944.88	1532019.81	5-4-23	15:42	76.30	77.66
692-08	375535.69	1531378.09	5-4-23	16:07	70.00	77.15
692-09	373575.83	1532395.09	5-4-23	16:24	85.36	91.07
692-10			5-4-23	15:53	75.25	77.90
EW-01						
EW-02						
EW-03						
EW-04						
EW-05						
Anthony Waste Water Treatment Plant						
MW-1	372097.86	1532364.36	5-4-23	14:30	65.40	79.95
MW-2	NM	NM	5-4-23	14:36	66.88	79.95
MW-3	NM	NM	5-4-23	14:41	59.26	78.40

MONITORING WELL GAUGING DATA
DONA ANA DAIRIES, DONA ANA COUNTY, NEW MEXICO

Monitoring Well	Northing ^a	Easting ^a	Date	Time	Depth to Water	Notes or Total Depth (ft)
ABATEMENT PLAN MONITOR WELLS						
DAD-01	422970.59	1512825.76	5-1-23	12:42	74.84	76.37
DAD-02	413002.98	1517319.93	5-3-23	9:36	68.40	68.23
DAD-03	407721.31	1516497.85	5-3-23	9:57	15.97	18.90
DAD-04	404576.66	1517413.28	5-3-23	11:52	Dry	18.65
DAD-05	396712.87	1519102.06	5-4-23	10:52	16.83	23.08
DAD-06R	404273.19	1522081.00	5-3-23	13:45	85.90	102.10
DAD-07	399270.18	1524320.88	5-3-23	15:18	93.15	100.68
DAD-08	395287.38	1522575.07	5-4-23	11:26	53.10	55.70
DAD-09	373259.30	1530905.70	5-4-23	13:27	57.21	61.24
DAD-10	372980.55	1532375.33	5-4-23	14:35	84.14	93.80
DAD-11	416211.35	1513814.71	5-2-23	14:55	24.19	47.52
DAD-12	419731.54	1512274.77	5-2-23	9:28	53.05	82.25
DAD-13	417879.08	1515673.13	5-2-23	14:41	88.53	92.77
DAD-14	414923.33	1514695.26	5-2-23	14:26	31.85	42.56
DAD-15	402001.22	1523552.04	5-3-23	11:05	97.01	109.90
DAD-16	400628.77	1519350.74	5-3-23	11:31	20.05	32.75
DAD-17	393991.97	1520267.94	5-4-23	10:44	21.66	38.87
DAD-18	395714.14	1520588.96	5-4-23	11:07	24.55	57.15
DAD-19	400164.47	1522027.92	5-4-23	9:12	66.28	99.35
DAD-20	371751.45	1531188.19	5-4-23	14:17	57.59	68.85
DAD-21	374013.39	1530983.98	5-4-23	13:19	58.40	66.50
DAD-22	373029.62	1530352.69	5-4-23	13:34	47.00	50.05
DAD-23	413958.29	1515697.17	5-3-23	9:18	46.46	57.75
DAD-24	400183.23	1522052.57	5-4-23	8:56	67.71	130.55
DAD-25	394560.83	1524599.12	5-4-23	11:53	67.52	77.19
DAD-26	372513.58	1530789.76	5-4-23	14:08	49.84	62.60
DAD-27			5-4-23	13:50	27.70	37.65
Notes:						
^a Horizontal control to NM State Plane Coordinates Central NAD83 Grid Coordinates (in feet)						
^b Measured in feet below the top of casing at survey point on north side of well						

Organ Dairy Mesquite, NM

Field Parameters and Sample Results for Monitoring wells 2nd Quarter 2023

Well ID	Sampling Date	Depth to water (ft)	TDS	Cl (mg/L)	TKN (mg/L)	NO3 (mg/L)	SO4 (mg/L)	EC (μS/cm)	pH	Temp (°C)	DO (mg/L)	ORP (mv)
MW 126-04	5/24/23	38.00	NS	NS	NS	NS	NS	NS	NS	NS	NS	NS
MW 126-05	5/24/23	30.70	NS	NS	NS	NS	NS	NS	NS	NS	NS	NS
MW 126-07	5/24/23	39.63	NS	NS	NS	NS	NS	NS	NS	NS	NS	NS
MW 126-09	5/24/23	82.25	NS	NS	NS	NS	NS	NS	NS	NS	NS	NS
MW 126-12	5/24/23	26.45	2110	400	1.4	3.2	490	3340	7.12	24.3	NS	NS
MW 126-13	5/24/23	46.50	3180	710	<2.0	14	810	4960	6.88	238	NS	NS

NS = Not Sampled

LRG-458S no longer running, barn being torn down.

MONITOR WELL DEVELOPMENT FIELD FORM

FLUID LEVEL DATA

Well ID 833-02 Date Gauged 5-16-23
 Site Big Sky Time Gauged 10:51

Depth to PSH _____ feet Well Diameter 4 inches
 Depth to Water 36.38 feet Height of Fluid Column 21.57 feet
 Total Depth 57.95 feet Volume in Well 14.236 gallons
 (3 Well Volumes = 42.70 gallons)

GROUNDWATER SAMPLING DATA

Time/date Purged 10:56 5-16-23 Purged Method Pump

Time	Purge Vol (gal)	Cumul Purge Vol (gal)	Temp (°C)	SpC (µs/cm)	pH	ORP (mV)	DO (mg/L)
<u>11:25</u>	<u>15</u>	<u>15</u>	<u>21.4</u>	<u>5966</u>	<u>7.39</u>	<u>211</u>	<u>1.74</u>
<u>11:50</u>	<u>15</u>	<u>30</u>	<u>20.9</u>	<u>5975</u>	<u>7.31</u>		
<u>12:18</u>	<u>13</u>	<u>43</u>	<u>20.7</u>	<u>5959</u>	<u>7.22</u>		

Actual Purge Volume 49 gals Field Measurements stabilized within ± 10% Y
 Time/Date Sampled 12:39 5-18-23 Purged/Sampled By A.A.
 Sample Method Pump
 Requested Analyses _____
 Comments/Observations _____

Well Casing Volumes
 2" diameter = 0.17 gal/ft 4" diameter = 0.66 gal/ft 5" diameter = 1.02 gal/ft 6" diameter = 1.50 gal/ft

MONITOR WELL DEVELOPMENT FIELD FORM

FLUID LEVEL DATA

Well ID 833-04 Date Gauged 5-16-23
 Site Big Sky Time Gauged 9:45
 Depth to PSH _____ feet Well Diameter 4 inches
 Depth to Water 45.04 feet Height of Fluid Column 8.26 feet
 Total Depth 53.30 feet Volume in Well 5.451 gallons
 (3 Well Volumes = 16.35 gallons)

GROUNDWATER SAMPLING DATA

Time/date Purged 9:52 5-16-23 Purged Method Pump

Time	Purge Vol (gal)	Cumul Purge Vol (gal)	Temp (°C)	SpC (µs/cm)	pH	ORP (mV)	DO (mg/L)
10:00	5	5	21.8	4341	7.45	164	2.33
10:10	5	10	21.7	4311	7.30		
10:17	7	17	21.5	4283	7.23		

Actual Purge Volume 22 gals Field Measurements stabilized within ± 10% y
 Time/Date Sampled 10:36 5-16-23 Purged/Sampled By A.K
 Sample Method Pump
 Requested Analyses _____
 Comments/Observations _____

Well Casing Volumes
 2" diameter = 0.17 gal/ft 4" diameter = 0.66 gal/ft 5" diameter = 1.02 gal/ft 6" diameter = 1.50 gal/ft

MONITOR WELL DEVELOPMENT FIELD FORM

FLUID LEVEL DATA

Well ID 833-06 Date Gauged 5-15-23
 Site Big Sky Time Gauged 15:08
 Depth to PSH _____ feet Well Diameter 4 inches
 Depth to Water 77.24 feet Height of Fluid Column 8.01 feet
 Total Depth 85.25 feet Volume in Well 5.286 gallons
 (3 Well Volumes = 15.85 gallons)

GROUNDWATER SAMPLING DATA

Time/date Purged 15:13 5-15-23 Purged Method Pump

Time	Purge Vol (gal)	Cumul Purge Vol (gal)	Temp (°C)	SpC (µs/cm)	pH	ORP (mV)	DO (mg/L)
15:21	5	5	21.7	3960	7.65	103	2.90
15:29	5	10	21.2	4031	7.52		
15:38	6	16	21.4	4261	7.30		

Actual Purge Volume 21 gals Field Measurements stabilized within ± 10% Y
 Time/Date Sampled 15:45 5-15-23 Purged/Sampled By A.N
 Sample Method Pump
 Requested Analyses _____
 Comments/Observations _____

Well Casing Volumes
 2" diameter = 0.17 gal/ft 4" diameter = 0.66 gal/ft 5" diameter = 1.02 gal/ft 6" diameter = 1.50 gal/ft

MONITOR WELL DEVELOPMENT FIELD FORM

FLUID LEVEL DATA

Well ID 833-07 Date Gauged 5-16-23
 Site Big Sky Time Gauged 14:43
 Depth to PSH _____ feet Well Diameter 4 inches
 Depth to Water 63.05 feet Height of Fluid Column 10.52 feet
 Total Depth 73.57 feet Volume in Well 6.943 gallons
 (3 Well Volumes = 20.81 gallons)

GROUNDWATER SAMPLING DATA

Time/date Purged 14:52 5-16-23 Purged Method Pump

Time	Purge Vol (gal)	Cumul Purge Vol (gal)	Temp (°C)	SpC (µs/cm)	pH	ORP (mV)	DO (mg/L)
15:05	7	7	22.7	6772	7.55	133	2.64
15:18	7	14	22.9	6621	7.36		
15:32	7	21	22.5	6590	7.20		

Actual Purge Volume 28 gals Field Measurements stabilized within ± 10% Y
 Time/Date Sampled 15:50 5-16-23 Purged/Sampled By A.N
 Sample Method Pump
 Requested Analyses _____
 Comments/Observations _____

Well Casing Volumes
 2" diameter = 0.17 gal/ft 4" diameter = 0.66 gal/ft 5" diameter = 1.02 gal/ft 6" diameter = 1.50 gal/ft

MONITOR WELL DEVELOPMENT FIELD FORM

FLUID LEVEL DATA

Well ID 833-08 Date Gauged 5-16-23
 Site Big Sky Time Gauged 13:38
 Depth to PSH _____ feet Well Diameter 4 inches
 Depth to Water 62.90 feet Height of Fluid Column 10.35 feet
 Total Depth 73.25 feet Volume in Well 6.831 gallons
 (3 Well Volumes = 20.49 gallons)

GROUNDWATER SAMPLING DATA

Time/date Purged 13:44 5-16-23 Purged Method Pump

Time	Purge Vol (gal)	Cumul Purge Vol (gal)	Temp (°C)	SpC (µs/cm)	pH	ORP (mV)	DO (mg/L)
13:58	8	8	23.0	5209	7.82	110	2.04
14:12	8	16	23.4	5150	7.71		
14:21	5	21	22.5	5104	7.48		
14:22	25	21.25	22.4	5120	7.41		

Actual Purge Volume 26 gals Field Measurements stabilized within ± 10% y
 Time/Date Sampled 14:27 5-16-23 Purged/Sampled By A.N.
 Sample Method Pump
 Requested Analyses _____
 Comments/Observations _____

Well Casing Volumes

2" diameter = 0.17 gal/ft 4" diameter = 0.66 gal/ft 5" diameter = 1.02 gal/ft 6" diameter = 1.50 gal/ft

MONITOR WELL DEVELOPMENT FIELD FORM

FLUID LEVEL DATA

Well ID 833-09 Date Gauged 5-17-23
 Site Big Sky Time Gauged 9:30
 Depth to PSH _____ feet Well Diameter 4 inches
 Depth to Water 29.01 feet Height of Fluid Column 10.67 feet
 Total Depth 39.68 feet Volume in Well 7.042 gallons
 (3 Well Volumes = 21.12 gallons)

GROUNDWATER SAMPLING DATA

Time/date Purged 9:35 5-17-23 Purged Method Pump

Time	Purge Vol (gal)	Cumul Purge Vol (gal)	Temp (°C)	SpC (µs/cm)	pH	ORP (mV)	DO (mg/L)
9:48	7	7	21.6	5707	7.45	156	2.44
9:54	7	14	21.5	5787	7.33		
10:08	7.25	21.25	21.9	5911	7.27		

Actual Purge Volume 28 gals Field Measurements stabilized within ± 10% Y
 Time/Date Sampled 10:21 5-17-23 Purged/Sampled By A.N
 Sample Method Pump
 Requested Analyses _____
 Comments/Observations _____

Well Casing Volumes
 2" diameter = 0.17 gal/ft 4" diameter = 0.66 gal/ft 5" diameter = 1.02 gal/ft 6" diameter = 1.50 gal/ft

MONITOR WELL DEVELOPMENT FIELD FORM

FLUID LEVEL DATA

Well ID 833-10 Date Gauged 5-17-23
 Site Big Sky Time Gauged 10:53
 Depth to PSH _____ feet Well Diameter 4 inches
 Depth to Water 23.50 feet Height of Fluid Column 14.25 feet
 Total Depth 37.75 feet Volume in Well 9.405 gallons
 (3 Well Volumes = 28.21 gallons)

GROUNDWATER SAMPLING DATA

Time/date Purged 10:59 5-17-23 Purged Method Pump

Time	Purge Vol (gal)	Cumul Purge Vol (gal)	Temp (°C)	SpC (µs/cm)	pH	ORP (mV)	DO (mg/L)
11:21	10	10	19.8	4275	7.76	131	2.09
11:42	10	20	19.6	4290	7.53		
12:03	10	30	19.4	4271	7.38		
12:06	25	30.25	19.1	4289	7.32		

Actual Purge Volume 35 gals Field Measurements stabilized within ± 10% Y

Time/Date Sampled 12:20 5-17-23 Purged/Sampled By A.N

Sample Method Pump

Requested Analyses _____

Comments/Observations _____

Well Casing Volumes
 2" diameter = 0.17 gal/ft 4" diameter = 0.66 gal/ft 5" diameter = 1.02 gal/ft 6" diameter = 1.50 gal/ft

MONITOR WELL DEVELOPMENT FIELD FORM

FLUID LEVEL DATA

Well ID 833-05 Date Gauged 7-3-23
 Site Big Sky Time Gauged 9:21

Depth to PSH _____ feet Well Diameter 4 inches
 Depth to Water 67.53 feet Height of Fluid Column 5.97 feet
 Total Depth 73.50 feet Volume in Well 3.940 gallons

(3 Well Volumes = 11.82 gallons)

GROUNDWATER SAMPLING DATA

Time/date Purged 9:27 7-3-23 Purged Method Pump

Time	Purge Vol (gal)	Cumul Purge Vol (gal)	Temp (°C)	SpC (µs/cm)	pH	ORP (mV)	DO (mg/L)
9:36	4	4	24.0	4640	7.43	152	1.35
9:44	4	8	23.5	4632	7.31		
9:55	4	12	23.1	4618	7.22		

Actual Purge Volume 16 gals Field Measurements stabilized within ± 10% Y
 Time/Date Sampled 10:15 7-3-23 Purged/Sampled By A.N
 Sample Method Pump
 Requested Analyses _____
 Comments/Observations _____

Well Casing Volumes
 2" diameter = 0.17 gal/ft 4" diameter = 0.66 gal/ft 5" diameter = 1.02 gal/ft 6" diameter = 1.50 gal/ft

MONITOR WELL DEVELOPMENT FIELD FORM

FLUID LEVEL DATA

Well ID 86/340-01 Date Gauged 5-5-23
 Site Bright Star Time Gauged 9:56

Depth to PSH _____ feet Well Diameter 4 inches
 Depth to Water 60.30 feet Height of Fluid Column 10.50 feet
 Total Depth 70.80 feet Volume in Well 6.93 gallons
 (3 Well Volumes = 20.79 gallons)

GROUNDWATER SAMPLING DATA

Time/date Purged 10:03 5-5-23 Purged Method Pump

Time	Purge Vol (gal)	Cumul Purge Vol (gal)	Temp (°C)	SpC (µs/cm)	pH	ORP (mV)	DO (mg/L)
10:18	7	7	20.4	3240	7.93	125	2.46
10:30	7	14	20.3	3250	7.58		
10:40	7	21	20.1	3221	7.28		

Actual Purge Volume 26 gals Field Measurements stabilized within ± 10% Y
 Time/Date Sampled 10:54 5-5-23 Purged/Sampled By AN
 Sample Method Pump
 Requested Analyses _____
 Comments/Observations _____

Well Casing Volumes
 2" diameter = 0.17 gal/ft 4" diameter = 0.66 gal/ft 5" diameter = 1.02 gal/ft 6" diameter = 1.50 gal/ft

MONITOR WELL DEVELOPMENT FIELD FORM

FLUID LEVEL DATA

Well ID 70/86/340-01 Date Gauged 5-5-23
 Site Bright Star Time Gauged 11:36
 Depth to PSH _____ feet Well Diameter 4 inches
 Depth to Water 53.96 feet Height of Fluid Column 13.98 feet
 Total Depth 67.94 feet Volume in Well 9.226 gallons
 (3 Well Volumes = 27.68 gallons)

GROUNDWATER SAMPLING DATA

Time/date Purged 11:42 5-5-23 Purged Method Pump

Time	Purge Vol (gal)	Cumul Purge Vol (gal)	Temp (°C)	SpC (µs/cm)	pH	ORP (mV)	DO (mg/L)
12:05	10	10	21.2	9212	7.60	141	2.73
12:27	10	20	20.8	9190	7.46		
12:41	8	28	20.7	9177	7.32		
12:43	25	28.25	20.6	9163	7.27		

Actual Purge Volume 33 gals Field Measurements stabilized within ± 10% Y
 Time/Date Sampled 13:05 5-5-23 Purged/Sampled By A.W
 Sample Method Pump
 Requested Analyses _____
 Comments/Observations _____

Well Casing Volumes
 2" diameter = 0.17 gal/ft 4" diameter = 0.66 gal/ft 5" diameter = 1.02 gal/ft 6" diameter = 1.50 gal/ft

MONITOR WELL DEVELOPMENT FIELD FORM

FLUID LEVEL DATA

Well ID 340-01 Date Gauged 5-5-23
 Site Bright Star Time Gauged 13:49

Depth to PSH _____ feet Well Diameter 4 inches
 Depth to Water 46.28 feet Height of Fluid Column 1.97 feet
 Total Depth 48.25 feet Volume in Well 1.300 gallons
 (3 Well Volumes = 3.90 gallons)

GROUNDWATER SAMPLING DATA

Time/date Purged 13:54 5-5-23 Purged Method Bail

Time	Purge Vol (gal)	Cumul Purge Vol (gal)	Temp (°C)	SpC (µs/cm)	pH	ORP (mV)	DO (mg/L)
14:18	1	1	23.9	4616	7.72	119	2.60
14:30	1	2	22.8	4522	7.40		
14:42	2	4	22.2	4514	7.29		

Actual Purge Volume 6 gals Field Measurements stabilized within ± 10% Y
 Time/Date Sampled 15:05 5-5-23 Purged/Sampled By A.W
 Sample Method Bail
 Requested Analyses _____
 Comments/Observations Very low water flow

Well Casing Volumes
 2" diameter = 0.17 gal/ft 4" diameter = 0.66 gal/ft 5" diameter = 1.02 gal/ft 6" diameter = 1.50 gal/ft

MONITOR WELL DEVELOPMENT FIELD FORM

FLUID LEVEL DATA

Well ID 340-02 Date Gauged 5-5-23
 Site Bright Star Time Gauged 15:20

Depth to PSH _____ feet Well Diameter _____ inches
 Depth to Water Dry feet Height of Fluid Column _____ feet
 Total Depth 56.90 feet Volume in Well _____ gallons

(3 Well Volumes = _____ gallons)

GROUNDWATER SAMPLING DATA

Time/date Purged _____ Purged Method _____

Time	Purge Vol (gal)	Cumul Purge Vol (gal)	Temp (°C)	SpC (µs/cm)	pH	ORP (mV)	DO (mg/L)

Actual Purge Volume _____ gals Field Measurements stabilized within ± 10% _____

Time/Date Sampled _____ Purged/Sampled By _____

Sample Method _____

Requested Analyses _____

Comments/Observations Dry well

Well Casing Volumes
 2" diameter = 0.17 gal/ft 4" diameter = 0.66 gal/ft 5" diameter = 1.02 gal/ft 6" diameter = 1.50 gal/ft

MONITOR WELL DEVELOPMENT FIELD FORM

FLUID LEVEL DATA

Well ID 74-01 Date Gauged 5-15-23
 Site Buena Vista II Time Gauged 9:50

Depth to PSH _____ feet Well Diameter 4 inches
 Depth to Water 39.10 feet Height of Fluid Column 6.15 feet
 Total Depth 45.25 feet Volume in Well 4.059 gallons
 (3 Well Volumes = 12.17 gallons)

GROUNDWATER SAMPLING DATA

Time/date Purged 9:56 5-15-23 Purged Method Pump

Time	Purge Vol (gal)	Cumul Purge Vol (gal)	Temp (°C)	SpC (µs/cm)	pH	ORP (mV)	DO (mg/L)
10:07	4	4	22.3	4749	7.50	133	1.73
10:19	4	8	22.5	4697	7.31		
10:37	4.25	12.25	22.7	4671	7.24		

Actual Purge Volume 17 gals Field Measurements stabilized within ± 10% Y
 Time/Date Sampled 10:52 5-15-23 Purged/Sampled By A.W
 Sample Method Pump
 Requested Analyses _____
 Comments/Observations _____

Well Casing Volumes
 2" diameter = 0.17 gal/ft 4" diameter = 0.66 gal/ft 5" diameter = 1.02 gal/ft 6" diameter = 1.50 gal/ft

MONITOR WELL DEVELOPMENT FIELD FORM

FLUID LEVEL DATA

Well ID 74-02 Date Gauged 5-12-23
 Site Buena Vista II Time Gauged 14:51
 Depth to PSH _____ feet Well Diameter 4 inches
 Depth to Water 18.75 feet Height of Fluid Column 1.59 feet
 Total Depth 20.34 feet Volume in Well 1.049 gallons
 (3 Well Volumes = 3.14 gallons)

GROUNDWATER SAMPLING DATA

Time/date Purged 14:54 5-12-23 Purged Method Bail

Time	Purge Vol (gal)	Cumul Purge Vol (gal)	Temp (°C)	SpC (µs/cm)	pH	ORP (mV)	DO (mg/L)
15:00	1	1	22.8	3867	7.31	84	2.92
15:10	1	2	23.9	3892	7.30		
15:28	1.50	3.50	23.7	3911	7.27		

Actual Purge Volume 5.50 gals Field Measurements stabilized within ± 10% Y
 Time/Date Sampled 15:45 5-12-23 Purged/Sampled By A.A
 Sample Method Bail
 Requested Analyses _____
 Comments/Observations very low water flow

Well Casing Volumes
 2" diameter = 0.17 gal/ft 4" diameter = 0.66 gal/ft 5" diameter = 1.02 gal/ft 6" diameter = 1.50 gal/ft

MONITOR WELL DEVELOPMENT FIELD FORM

FLUID LEVEL DATA

Well ID 74-03 Date Gauged 5-12-23
 Site Buena Vista II Time Gauged 14:05
 Depth to PSH _____ feet Well Diameter 4 inches
 Depth to Water 19.12 feet Height of Fluid Column 1.18 feet
 Total Depth 20.30 feet Volume in Well 0.778 gallons
 (3 Well Volumes = 2.33 gallons)

GROUNDWATER SAMPLING DATA

Time/date Purged 14:09 5-12-23 Purged Method Bail

Time	Purge Vol (gal)	Cumul Purge Vol (gal)	Temp (°C)	SpC (µs/cm)	pH	ORP (mV)	DO (mg/L)
14:13	1	1	22.6	2563	8.00	91	1.88
14:19	1	2	21.8	2521	7.66		
14:26	1	3	21.9	2507	7.44		
14:28	25	3.25	22.0	2493	7.32		

Actual Purge Volume 5 gals Field Measurements stabilized within ± 10% y
 Time/Date Sampled 14:38 5-12-23 Purged/Sampled By A. W
 Sample Method Bail
 Requested Analyses _____
 Comments/Observations _____

Well Casing Volumes
 2" diameter = 0.17 gal/ft 4" diameter = 0.66 gal/ft 5" diameter = 1.02 gal/ft 6" diameter = 1.50 gal/ft

MONITOR WELL DEVELOPMENT FIELD FORM

FLUID LEVEL DATA

Well ID 74-04 Date Gauged 5-15-23
 Site Buena Vista II Time Gauged 11:10
 Depth to PSH _____ feet Well Diameter 4 inches
 Depth to Water 51.03 feet Height of Fluid Column 6.87 feet
 Total Depth 57.90 feet Volume in Well 4.534 gallons
 (3 Well Volumes = 13.60 gallons)

GROUNDWATER SAMPLING DATA

Time/date Purged 11:16 5-15-23 Purged Method Pump

Time	Purge Vol (gal)	Cumul Purge Vol (gal)	Temp (°C)	SpC (µs/cm)	pH	ORP (mV)	DO (mg/L)
11:35	5	5	22.6	2840	7.80	79	2.13
11:50	5	10	22.5	2900	7.65		
12:05	4	14	22.1	2923	7.40		
12:08	25	14.25	22.0	2915	7.33		

Actual Purge Volume 20 gals Field Measurements stabilized within ± 10% Y
 Time/Date Sampled 12:30 5-15-23 Purged/Sampled By A.W.
 Sample Method Pump
 Requested Analyses _____
 Comments/Observations _____

Well Casing Volumes
 2" diameter = 0.17 gal/ft 4" diameter = 0.66 gal/ft 5" diameter = 1.02 gal/ft 6" diameter = 1.50 gal/ft

MONITOR WELL DEVELOPMENT FIELD FORM

FLUID LEVEL DATA

Well ID 74-05 Date Gauged 5-15-23
 Site Buena Vista II Time Gauged 13:22

Depth to PSH _____ feet Well Diameter 4 inches
 Depth to Water 43.20 feet Height of Fluid Column 13.95 feet
 Total Depth 57.15 feet Volume in Well 9.207 gallons
 (3 Well Volumes = 27.62 gallons)

GROUNDWATER SAMPLING DATA

Time/date Purged 13:30 5-15-23 Purged Method Pump

Time	Purge Vol (gal)	Cumul Purge Vol (gal)	Temp (°C)	SpC (µs/cm)	pH	ORP (mV)	DO (mg/L)
13:52	10	10	23.4	3609	7.55	307	2.68
14:18	10	20	23.6	3563	7.37		
14:34	8	28	23.3	3550	7.27		

Actual Purge Volume 34 gals Field Measurements stabilized within ± 10% Y
 Time/Date Sampled 14:47 5-15-23 Purged/Sampled By A.N
 Sample Method Pump
 Requested Analyses _____
 Comments/Observations _____

Well Casing Volumes
 2" diameter = 0.17 gal/ft 4" diameter = 0.66 gal/ft 5" diameter = 1.02 gal/ft 6" diameter = 1.50 gal/ft

MONITOR WELL DEVELOPMENT FIELD FORM

FLUID LEVEL DATA

Well ID DAD-01 Date Gauged 5-25-23
 Site DAD'S Time Gauged 9:50

Depth to PSH _____ feet Well Diameter 2 inches
 Depth to Water 74.81 feet Height of Fluid Column 1.54 feet
 Total Depth 76.35 feet Volume in Well 0.2618 gallons
 (3 Well Volumes = 0.78 gallons)

GROUNDWATER SAMPLING DATA

Time/date Purged 9:55 5-25-23 Purged Method Bail

Time	Purge Vol (gal)	Cumul Purge Vol (gal)	Temp (°C)	SpC (µs/cm)	pH	ORP (mV)	DO (mg/L)
10:00	.25	.25	24.9	2417	7.46	155	1.71
10:03	.25	.50	24.6	2442	7.33		
10:11	.50	1	24.7	2467	7.25		

Actual Purge Volume 2.50 gals Field Measurements stabilized within ± 10% Y
 Time/Date Sampled 10:31 5-25-23 Purged/Sampled By A.W
 Sample Method Bail
 Requested Analyses _____
 Comments/Observations _____

Well Casing Volumes
 2" diameter = 0.17 gal/ft 4" diameter = 0.66 gal/ft 5" diameter = 1.02 gal/ft 6" diameter = 1.50 gal/ft

MONITOR WELL DEVELOPMENT FIELD FORM

FLUID LEVEL DATA

Well ID DAD-02 Date Gauged 5-26-23
 Site DAD'S Time Gauged 13:05

Depth to PSH _____ feet Well Diameter 2 inches
 Depth to Water 68.15 feet Height of Fluid Column .25 feet
 Total Depth 68.40 feet Volume in Well 0.042 gallons
 (3 Well Volumes = 0.12 gallons)

GROUNDWATER SAMPLING DATA

Time/date Purged 13:10 5-26-23 Purged Method Bail

Time	Purge Vol (gal)	Cumul Purge Vol (gal)	Temp (°C)	SpC (µs/cm)	pH	ORP (mV)	DO (mg/L)
13:15	.25	.25	28.0	2733	7.53	101	1.99
13:20	.25	.50	25.0	2737	7.37		
13:25	.25	.75	25.1	2750	7.28		

Actual Purge Volume .75 gals Field Measurements stabilized within ± 10% Y
 Time/Date Sampled 13:30 5-26-23 Purged/Sampled By A.N
 Sample Method Bail
 Requested Analyses _____
 Comments/Observations Very low water

Well Casing Volumes
 2" diameter = 0.17 gal/ft 4" diameter = 0.66 gal/ft 5" diameter = 1.02 gal/ft 6" diameter = 1.50 gal/ft

MONITOR WELL DEVELOPMENT FIELD FORM

FLUID LEVEL DATA

Well ID DAD-03 Date Gauged 5-26-23
 Site DAD'S Time Gauged 14:26

Depth to PSH _____ feet Well Diameter 2 inches
 Depth to Water 15.95 feet Height of Fluid Column 2.95 feet
 Total Depth 18.90 feet Volume in Well 0.501 gallons
 (3 Well Volumes = 1.50 gallons)

GROUNDWATER SAMPLING DATA

Time/date Purged 14:33 5-26-23 Purged Method Bail

Time	Purge Vol (gal)	Cumul Purge Vol (gal)	Temp (°C)	SpC (µs/cm)	pH	ORP (mV)	DO (mg/L)
14:41	.50	.50	22.7	2560	7.55	93	1.28
14:48	.50	1	21.4	2590	7.43		
14:54	.50	1.50	21.6	2600	7.31		

Actual Purge Volume 3 gals Field Measurements stabilized within ± 10% Y
 Time/Date Sampled 15:25 5-26-23 Purged/Sampled By A.N
 Sample Method Bail
 Requested Analyses _____
 Comments/Observations _____

Well Casing Volumes
 2" diameter = 0.17 gal/ft 4" diameter = 0.66 gal/ft 5" diameter = 1.02 gal/ft 6" diameter = 1.50 gal/ft

MONITOR WELL DEVELOPMENT FIELD FORM

FLUID LEVEL DATA

Well ID DAD-04 Date Gauged 5-30-23
 Site DAD'S Time Gauged 13:48

Depth to PSH _____ feet Well Diameter 2 inches
 Depth to Water Dry feet Height of Fluid Column _____ feet
 Total Depth 18.65 feet Volume in Well _____ gallons

(3 Well Volumes = _____ gallons)

GROUNDWATER SAMPLING DATA

Time/date Purged _____ Purged Method _____

Time	Purge Vol (gal)	Cumul Purge Vol (gal)	Temp (°C)	SpC (µs/cm)	pH	ORP (mV)	DO (mg/L)

Actual Purge Volume _____ gals Field Measurements stabilized within ± 10% _____
 Time/Date Sampled _____ Purged/Sampled By _____
 Sample Method _____
 Requested Analyses _____
 Comments/Observations Dry well

Well Casing Volumes
 2" diameter = 0.17 gal/ft 4" diameter = 0.66 gal/ft 5" diameter = 1.02 gal/ft 6" diameter = 1.50 gal/ft

MONITOR WELL DEVELOPMENT FIELD FORM

FLUID LEVEL DATA

Well ID DAD-05 Date Gauged 6-1-23
 Site DAD'S Time Gauged 14:50

Depth to PSH _____ feet Well Diameter 2 inches
 Depth to Water 16.80 feet Height of Fluid Column 6.30 feet
 Total Depth 23.10 feet Volume in Well 1.071 gallons
 (3 Well Volumes = 3.21 gallons)

GROUNDWATER SAMPLING DATA

Time/date Purged 14:55 6-1-23 Purged Method Bail

Time	Purge Vol (gal)	Cumul Purge Vol (gal)	Temp (°C)	SpC (µs/cm)	pH	ORP (mV)	DO (mg/L)
15:05	1	1	19.1	1206	7.62	97	1.05
15:15	1	2	18.3	1241	7.41		
15:29	1.50	3.50	19.0	1320	7.32		
15:32	-25	3.75	19.3	1350	7.27		

Actual Purge Volume 6.25 gals Field Measurements stabilized within ± 10% Y
 Time/Date Sampled 15:50 6-1-23 Purged/Sampled By A.N
 Sample Method Bail
 Requested Analyses _____
 Comments/Observations _____

Well Casing Volumes
 2" diameter = 0.17 gal/ft 4" diameter = 0.66 gal/ft 5" diameter = 1.02 gal/ft 6" diameter = 1.50 ga/ft

MONITOR WELL DEVELOPMENT FIELD FORM

FLUID LEVEL DATA

Well ID DAD-06R Date Gauged 5-30-23
 Site DAD'S Time Gauged 14:19

Depth to PSH _____ feet Well Diameter 2 inches
 Depth to Water 85.87 feet Height of Fluid Column 16.23 feet
 Total Depth 102.10 feet Volume in Well 2.759 gallons
 (3 Well Volumes = 8.27 gallons)

GROUNDWATER SAMPLING DATA

Time/date Purged 14:24 5-30-23 Purged Method Pump

Time	Purge Vol (gal)	Cumul Purge Vol (gal)	Temp (°C)	SpC (µs/cm)	pH	ORP (mV)	DO (mg/L)
14:40	3	3	26.2	1206	7.08	79	1.25
14:57	3	6	26.6	1108	7.19		
15:20	3	9	27.0	1315	7.23		

Actual Purge Volume 12 gals Field Measurements stabilized within ± 10% Y
 Time/Date Sampled 15:50 5-30-23 Purged/Sampled By A-i
 Sample Method Pump
 Requested Analyses _____
 Comments/Observations _____

Well Casing Volumes
 2" diameter = 0.17 gal/ft 4" diameter = 0.66 gal/ft 5" diameter = 1.02 gal/ft 6" diameter = 1.50 gal/ft

MONITOR WELL DEVELOPMENT FIELD FORM

FLUID LEVEL DATA

Well ID DAD-07 Date Gauged 6-5-23
 Site DAD's Time Gauged 14:50

Depth to PSH _____ feet Well Diameter 2 inches
 Depth to Water 93.14 feet Height of Fluid Column 7.53 feet
 Total Depth 100.67 feet Volume in Well 1.280 gallons
 (3 Well Volumes = 3.84 gallons)

GROUNDWATER SAMPLING DATA

Time/date Purged 14:56 6-5-23 Purged Method Bail

Time	Purge Vol (gal)	Cumul Purge Vol (gal)	Temp (°C)	SpC (µs/cm)	pH	ORP (mV)	DO (mg/L)
15:12	1	1	25.9	3471	7.55	124	2.61
15:23	1	2	25.0	3649	7.39		
15:39	2	4	25.3	3694	7.30		
15:41	2.25	4.25	25.6	3698	7.28		

Actual Purge Volume 6 gals Field Measurements stabilized within ± 10% ✓
 Time/Date Sampled 15:55 6-5-23 Purged/Sampled By A. N
 Sample Method Bail
 Requested Analyses _____
 Comments/Observations _____

Well Casing Volumes

2" diameter = 0.17 gal/ft 4" diameter = 0.66 gal/ft 5" diameter = 1.02 gal/ft 6" diameter = 1.50 gal/ft

MONITOR WELL DEVELOPMENT FIELD FORM

FLUID LEVEL DATA

Well ID DAD-08 Date Gauged 6-5-23
 Site DAD₄ Time Gauged 11:18

Depth to PSH _____ feet Well Diameter 2 inches
 Depth to Water 53.06 feet Height of Fluid Column 2.64 feet
 Total Depth 55.70 feet Volume in Well 0.448 gallons
 (3 Well Volumes = 1.34 gallons)

GROUNDWATER SAMPLING DATA

Time/date Purged 11:24 6-5-23 Purged Method Bail

Time	Purge Vol (gal)	Cumul Purge Vol (gal)	Temp (°C)	SpC (µs/cm)	pH	ORP (mV)	DO (mg/L)
11:35	.50	.50	22.1	6534	7.33	140	2.22
11:47	.50	1	22.0	6545	7.28		
12:00	.50	1.50	22.4	6590	7.24		

Actual Purge Volume 2.50 gals Field Measurements stabilized within ± 10% Y
 Time/Date Sampled 12:10 6-5-23 Purged/Sampled By AN
 Sample Method Bail
 Requested Analyses _____
 Comments/Observations _____

Well Casing Volumes
 2" diameter = 0.17 gal/ft 4" diameter = 0.66 gal/ft 5" diameter = 1.02 gal/ft 6" diameter = 1.50 gal/ft

MONITOR WELL DEVELOPMENT FIELD FORM

FLUID LEVEL DATA

Well ID DAD-09 Date Gauged 6-6-23
 Site DAD'S Time Gauged 10:25

Depth to PSH _____ feet Well Diameter 2 inches
 Depth to Water 57.22 feet Height of Fluid Column 4.03 feet
 Total Depth 61.25 feet Volume in Well 0.6851 gallons
 (3 Well Volumes = 2.05 gallons)

GROUNDWATER SAMPLING DATA

Time/date Purged 10:30 6-6-23 Purged Method Bail

Time	Purge Vol (gal)	Cumul Purge Vol (gal)	Temp (°C)	SpC (µs/cm)	pH	ORP (mV)	DO (mg/L)
10:35	.50	.50	23.6	2745	7.09	150	2.06
10:40	.50	1	23.7	2882	7.14		
10:51	1.25	2.25	23.9	2964	7.23		

Actual Purge Volume 4 gals Field Measurements stabilized within ± 10% Y
 Time/Date Sampled 11:15 6-6-23 Purged/Sampled By A.N
 Sample Method Bail
 Requested Analyses _____
 Comments/Observations _____

Well Casing Volumes
 2" diameter = 0.17 gal/ft 4" diameter = 0.66 gal/ft 5" diameter = 1.02 gal/ft 6" diameter = 1.50 gal/ft

MONITOR WELL DEVELOPMENT FIELD FORM

FLUID LEVEL DATA

Well ID DAD-10 Date Gauged 6-9-23
 Site DAD's Time Gauged 11:12

Depth to PSH _____ feet Well Diameter 2 inches
 Depth to Water 84.11 feet Height of Fluid Column 9.70 feet
 Total Depth 93.81 feet Volume in Well 1.649 gallons
 (3 Well Volumes = 4.94 gallons)

GROUNDWATER SAMPLING DATA

Time/date Purged 11:18 6-9-23 Purged Method Bail

Time	Purge Vol (gal)	Cumul Purge Vol (gal)	Temp (°C)	SpC (µs/cm)	pH	ORP (mV)	DO (mg/L)
11:38	2	2	21.4	2174	7.10	136	1.60
11:59	2	4	21.6	2162	7.18		
12:13	1	5	21.8	2151	7.22		

Actual Purge Volume 7 gals Field Measurements stabilized within ± 10% Y
 Time/Date Sampled 12:36 6-9-23 Purged/Sampled By A.N
 Sample Method Bail
 Requested Analyses _____
 Comments/Observations _____

Well Casing Volumes
 2" diameter = 0.17 gal/ft 4" diameter = 0.66 gal/ft 5" diameter = 1.02 gal/ft 6" diameter = 1.50 ga/ft

MONITOR WELL DEVELOPMENT FIELD FORM

FLUID LEVEL DATA

Well ID DAD-11 Date Gauged 5-25-23
 Site DAD'S Time Gauged 14:12

Depth to PSH _____ feet Well Diameter 4 inches
 Depth to Water 24.15 feet Height of Fluid Column 23.39 feet
 Total Depth 47.54 feet Volume in Well 15.437 gallons
 (3 Well Volumes = 46.31 gallons)

GROUNDWATER SAMPLING DATA

Time/date Purged 14:17 5-25-23 Purged Method Pump

Time	Purge Vol (gal)	Cumul Purge Vol (gal)	Temp (°C)	SpC (µs/cm)	pH	ORP (mV)	DO (mg/L)
14:50	15	15	23.6	4691	8.01	131	1.63
15:21	15	30	23.1	4735	7.62		
15:55	17	47	22.1	4778	7.22		

Actual Purge Volume 52 gals Field Measurements stabilized within ± 10% Y
 Time/Date Sampled 16:25 5-25-23 Purged/Sampled By A.W
 Sample Method Pump
 Requested Analyses _____
 Comments/Observations _____

Well Casing Volumes
 2" diameter = 0.17 gal/ft 4" diameter = 0.66 gal/ft 5" diameter = 1.02 gal/ft 6" diameter = 1.50 gal/ft

MONITOR WELL DEVELOPMENT FIELD FORM

FLUID LEVEL DATA

Well ID DAD-12 Date Gauged 5-25-23
 Site DAD's Time Gauged 11:15

Depth to PSH _____ feet Well Diameter 2 inches
 Depth to Water 53.03 feet Height of Fluid Column 29.22 feet
 Total Depth 82.25 feet Volume in Well 4.967 gallons
 (3 Well Volumes = 14.90 gallons)

GROUNDWATER SAMPLING DATA

Time/date Purged 11:21 5-25-23 Purged Method Pump

Time	Purge Vol (gal)	Cumul Purge Vol (gal)	Temp (°C)	SpC (µs/cm)	pH	ORP (mV)	DO (mg/L)
11:32	5	5	22.9	4680	7.44	148	2.33
11:43	5	10	22.5	4692	7.39		
11:53	5	15	22.6	4656	7.24		

Actual Purge Volume 20 gals Field Measurements stabilized within ± 10% Y
 Time/Date Sampled 12:20 5-25-23 Purged/Sampled By A.N
 Sample Method Pump
 Requested Analyses _____
 Comments/Observations _____

Well Casing Volumes
 2" diameter = 0.17 gal/ft 4" diameter = 0.66 gal/ft 5" diameter = 1.02 gal/ft 6" diameter = 1.50 ga/ft

MONITOR WELL DEVELOPMENT FIELD FORM

FLUID LEVEL DATA

Well ID DAD-13 Date Gauged 5-25-23
 Site DAD'S Time Gauged 13:05

Depth to PSH _____ feet Well Diameter 2 inches
 Depth to Water 88.51 feet Height of Fluid Column 4.27 feet
 Total Depth 92.78 feet Volume in Well 0.725 gallons
 (3 Well Volumes = 2.17 gallons)

GROUNDWATER SAMPLING DATA

Time/date Purged 13:10 5-25-23 Purged Method Bail

Time	Purge Vol (gal)	Cumul Purge Vol (gal)	Temp (°C)	SpC (µs/cm)	pH	ORP (mV)	DO (mg/L)
13:20	1	1	26.6	3737	7.92	127	2.81
13:30	1	2	26.1	3615	7.70		
13:41	1	3	25.5	3570	7.51		
13:43	.25	3.25	25.4	3550	7.42		

Actual Purge Volume 5 gals Field Measurements stabilized within ± 10% Y
 Time/Date Sampled 14:02 5-25-23 Purged/Sampled By A:W
 Sample Method Bail
 Requested Analyses _____
 Comments/Observations _____

Well Casing Volumes
 2" diameter = 0.17 gal/ft 4" diameter = 0.66 gal/ft 5" diameter = 1.02 gal/ft 6" diameter = 1.50 gal/ft

MONITOR WELL DEVELOPMENT FIELD FORM

FLUID LEVEL DATA

Well ID DAD-14 Date Gauged 5-26-23
 Site DAD's Time Gauged 9:57

Depth to PSH _____ feet Well Diameter 2 inches
 Depth to Water 31.84 feet Height of Fluid Column 10.73 feet
 Total Depth 42.57 feet Volume in Well 1.824 gallons
 (3 Well Volumes = 5.47 gallons)

GROUNDWATER SAMPLING DATA

Time/date Purged 10:04 5-26-23 Purged Method Pump

Time	Purge Vol (gal)	Cumul Purge Vol (gal)	Temp (°C)	SpC (µs/cm)	pH	ORP (mV)	DO (mg/L)
10:16	2	2	22.1	5760	7.52	149	2.94
10:35	2	4	21.9	5873	7.40		
10:47	2	6	21.7	5895	7.30		
10:49	.25	6.25	21.8	5906	7.28		

Actual Purge Volume 10 gals Field Measurements stabilized within ± 10% Y
 Time/Date Sampled 11:08 5-26-23 Purged/Sampled By A.N
 Sample Method Pump
 Requested Analyses _____
 Comments/Observations _____

Well Casing Volumes
 2" diameter = 0.17 gal/ft 4" diameter = 0.66 gal/ft 5" diameter = 1.02 gal/ft 6" diameter = 1.50 gal/ft

MONITOR WELL DEVELOPMENT FIELD FORM

FLUID LEVEL DATA

Well ID DAD-15 Date Gauged 5-30-23
 Site DAD's Time Gauged 10:05

Depth to PSH _____ feet Well Diameter 2 inches
 Depth to Water 97.00 feet Height of Fluid Column 12.90 feet
 Total Depth 109.90 feet Volume in Well 2.193 gallons
 (3 Well Volumes = 6.57 gallons)

GROUNDWATER SAMPLING DATA

Time/date Purged 10:10 5-30-23 Purged Method Pump

Time	Purge Vol (gal)	Cumul Purge Vol (gal)	Temp (°C)	SpC (µs/cm)	pH	ORP (mV)	DO (mg/L)
10:25	2	2	24.9	3552	7.82	140	2.68
10:35	2	4	25.0	3527	7.50		
10:50	3	7	25.3	3488	7.31		

Actual Purge Volume 10 gals Field Measurements stabilized within ± 10% Y
 Time/Date Sampled 11:18 5-30-23 Purged/Sampled By A.N.
 Sample Method Pump
 Requested Analyses _____
 Comments/Observations _____

Well Casing Volumes
 2" diameter = 0.17 gal/ft 4" diameter = 0.66 gal/ft 5" diameter = 1.02 gal/ft 6" diameter = 1.50 gal/ft

MONITOR WELL DEVELOPMENT FIELD FORM

FLUID LEVEL DATA

Well ID DAD-16 Date Gauged 5-30-23
 Site DAD's Time Gauged 11:58

Depth to PSH _____ feet Well Diameter 2 inches
 Depth to Water 20.03 feet Height of Fluid Column 12.72 feet
 Total Depth 32.75 feet Volume in Well 2.162 gallons
 (3 Well Volumes = 6.48 gallons)

GROUNDWATER SAMPLING DATA

Time/date Purged 12:06 5-30-23 Purged Method Pump

Time	Purge Vol (gal)	Cumul Purge Vol (gal)	Temp (°C)	SpC (µs/cm)	pH	ORP (mV)	DO (mg/L)
12:41	2	2	21.0	2773	7.33	149	2.09
12:53	2	4	20.2	2760	7.28		
13:15	3	7	20.7	2806	7.21		

Actual Purge Volume 10 gals Field Measurements stabilized within ± 10% Y
 Time/Date Sampled 13:31 5-30-23 Purged/Sampled By A.N
 Sample Method Pump
 Requested Analyses _____
 Comments/Observations Pump stopped working - Troubleshoot it. Working now.

Well Casing Volumes
 2" diameter = 0.17 gal/ft 4" diameter = 0.66 gal/ft 5" diameter = 1.02 gal/ft 6" diameter = 1.50 gal/ft

MONITOR WELL DEVELOPMENT FIELD FORM

FLUID LEVEL DATA

Well ID DAD-17 Date Gauged 6-1-23
 Site DAD'S Time Gauged 13:28

Depth to PSH _____ feet Well Diameter 2 inches
 Depth to Water 21.64 feet Height of Fluid Column 17.26 feet
 Total Depth 38.90 feet Volume in Well 2934 gallons
 (3 Well Volumes = 8.80 gallons)

GROUNDWATER SAMPLING DATA

Time/date Purged 13:34 6-1-23 Purged Method Pump

Time	Purge Vol (gal)	Cumul Purge Vol (gal)	Temp (°C)	SpC (µs/cm)	pH	ORP (mV)	DO (mg/L)
13:40	3	3	21.3	1532	7.46	105	1.10
13:49	3	6	20.8	1546	7.30		
13:58	3	9	20.7	1528	7.25		

Actual Purge Volume 13 gals Field Measurements stabilized within ± 10% Y
 Time/Date Sampled 14:36 6-1-23 Purged/Sampled By A.N
 Sample Method Pump
 Requested Analyses _____
 Comments/Observations _____

Well Casing Volumes
 2" diameter = 0.17 gal/ft 4" diameter = 0.66 gal/ft 5" diameter = 1.02 gal/ft 6" diameter = 1.50 ga/ft

MONITOR WELL DEVELOPMENT FIELD FORM

FLUID LEVEL DATA

Well ID DAD-18 Date Gauged 6-5-23
 Site DAD's Time Gauged 9:45

Depth to PSH _____ feet Well Diameter 2 inches
 Depth to Water 24.53 feet Height of Fluid Column 32.62 feet
 Total Depth 57.15 feet Volume in Well 5.545 gallons

(3 Well Volumes = 16.63 gallons)

GROUNDWATER SAMPLING DATA

Time/date Purged 9:57 6-5-23 Purged Method Pump

Time	Purge Vol (gal)	Cumul Purge Vol (gal)	Temp (°C)	SpC (µs/cm)	pH	ORP (mV)	DO (mg/L)
10:15	5	5	18.9	4186	7.56	146	2.46
10:25	5	10	18.3	4148	7.40		
10:43	7	17	18.5	4110	7.27		

Actual Purge Volume 22 gals Field Measurements stabilized within ± 10% Y
 Time/Date Sampled 10:56 6-5-23 Purged/Sampled By A.N
 Sample Method Pump
 Requested Analyses _____
 Comments/Observations _____

Well Casing Volumes

2" diameter = 0.17 gal/ft 4" diameter = 0.66 gal/ft 5" diameter = 1.02 gal/ft 6" diameter = 1.50 ga/ft

MONITOR WELL DEVELOPMENT FIELD FORM

FLUID LEVEL DATA

Well ID DAD-19 Date Gauged 6-1-23
 Site DAD's Time Gauged 11:15

Depth to PSH _____ feet Well Diameter 2 inches
 Depth to Water 66.27 feet Height of Fluid Column 33.08 feet
 Total Depth 99.35 feet Volume in Well 5.623 gallons
 (3 Well Volumes = 16.87 gallons)

GROUNDWATER SAMPLING DATA

Time/date Purged 11:21 6-1-23 Purged Method Pump

Time	Purge Vol (gal)	Cumul Purge Vol (gal)	Temp (°C)	SpC (µs/cm)	pH	ORP (mV)	DO (mg/L)
11:33	5	5	23.0	4720	6.98	156	1.84
11:45	5	10	22.5	4731	7.12		
12:00	7	17	22.3	4744	7.20		

Actual Purge Volume 23 gals Field Measurements stabilized within ± 10% Y
 Time/Date Sampled 12:20 6-1-23 Purged/Sampled By A-N
 Sample Method Pump
 Requested Analyses _____
 Comments/Observations _____

Well Casing Volumes
 2" diameter = 0.17 gal/ft 4" diameter = 0.66 gal/ft 5" diameter = 1.02 gal/ft 6" diameter = 1.50 gal/ft

MONITOR WELL DEVELOPMENT FIELD FORM

FLUID LEVEL DATA

Well ID DAD-20 Date Gauged 6-9-23
 Site DAD'S Time Gauged 9:35

Depth to PSH _____ feet Well Diameter 2 inches
 Depth to Water 57.56 feet Height of Fluid Column 11.29 feet
 Total Depth 68.85 feet Volume in Well 1.919 gallons
 (3 Well Volumes = 5.75 gallons)

GROUNDWATER SAMPLING DATA

Time/date Purged 9:41 6-9-23 Purged Method Bail

Time	Purge Vol (gal)	Cumul Purge Vol (gal)	Temp (°C)	SpC (µs/cm)	pH	ORP (mV)	DO (mg/L)
9:55	2	2	22.9	4057	7.55	131	1.22
10:08	2	4	22.8	4069	7.30		
10:20	2	6	22.7	4076	7.23		

Actual Purge Volume 8 gals Field Measurements stabilized within ± 10% Y
 Time/Date Sampled 10:45 6-9-23 Purged/Sampled By A.N
 Sample Method Bail
 Requested Analyses _____
 Comments/Observations _____

Well Casing Volumes
 2" diameter = 0.17 gal/ft 4" diameter = 0.66 gal/ft 5" diameter = 1.02 gal/ft 6" diameter = 1.50 gal/ft

MONITOR WELL DEVELOPMENT FIELD FORM

FLUID LEVEL DATA

Well ID DAD-21 Date Gauged 6-6-23
 Site DAD's Time Gauged 9:20

Depth to PSH _____ feet Well Diameter 2 inches
 Depth to Water 58.39 feet Height of Fluid Column 8.11 feet
 Total Depth 66.50 feet Volume in Well 1.378 gallons
 (3 Well Volumes = 4.13 gallons)

GROUNDWATER SAMPLING DATA

Time/date Purged 9:23 6-6-23 Purged Method Bail

Time	Purge Vol (gal)	Cumul Purge Vol (gal)	Temp (°C)	SpC (µs/cm)	pH	ORP (mV)	DO (mg/L)
9:35	1.50	1.50	22.7	3626	7.49	141	2.79
9:46	1.50	3	22.6	4273	7.26		
9:57	1.50	4.50	22.8	4305	7.19		

Actual Purge Volume 6.50 gals Field Measurements stabilized within ± 10% Y
 Time/Date Sampled 10:07 6-6-23 Purged/Sampled By A.N
 Sample Method Bail
 Requested Analyses _____
 Comments/Observations low water flow

Well Casing Volumes
 2" diameter = 0.17 gal/ft 4" diameter = 0.66 gal/ft 5" diameter = 1.02 gal/ft 6" diameter = 1.50 gal/ft

MONITOR WELL DEVELOPMENT FIELD FORM

FLUID LEVEL DATA

Well ID DAD-22 Date Gauged 6-6-23
 Site DAD'S Time Gauged 11:27

Depth to PSH _____ feet Well Diameter 2 inches
 Depth to Water 46.98 feet Height of Fluid Column 307 feet
 Total Depth 50.05 feet Volume in Well 0.521 gallons
 (3 Well Volumes = 1.50 gallons)

GROUNDWATER SAMPLING DATA

Time/date Purged 11:33 6-6-23 Purged Method Bail

Time	Purge Vol (gal)	Cumul Purge Vol (gal)	Temp (°C)	SpC (µs/cm)	pH	ORP (mV)	DO (mg/L)
11:36	.50	.50	24.7	3460	7.38	133	2.60
11:45	.50	1	23.7	3687	7.32		
11:52	.75	1.75	23.9	3700	7.24		

Actual Purge Volume 2.50 gals Field Measurements stabilized within ± 10% Y
 Time/Date Sampled 12:05 6-6-23 Purged/Sampled By A.N
 Sample Method Bail
 Requested Analyses _____
 Comments/Observations low water

Well Casing Volumes
 2" diameter = 0.17 gal/ft 4" diameter = 0.66 gal/ft 5" diameter = 1.02 gal/ft 6" diameter = 1.50 gal/ft

MONITOR WELL DEVELOPMENT FIELD FORM

FLUID LEVEL DATA

Well ID DAD-23 Date Gauged 5-26-23
 Site DAD's Time Gauged 11:20

Depth to PSH _____ feet Well Diameter 2 inches
 Depth to Water 46.44 feet Height of Fluid Column 11.31 feet
 Total Depth 57.75 feet Volume in Well 1.922 gallons

(3 Well Volumes = 5.76 gallons)

GROUNDWATER SAMPLING DATA

Time/date Purged 11:24 5-26-23 Purged Method Bail

Time	Purge Vol (gal)	Cumul Purge Vol (gal)	Temp (°C)	SpC (µs/cm)	pH	ORP (mV)	DO (mg/L)
11:36	2	2	23.9	3374	7.74	148	2.53
11:48	2	4	23.5	3721	7.32		
12:10	2	6	23.3	3760	7.22		

Actual Purge Volume 8 gals Field Measurements stabilized within ± 10% Y
 Time/Date Sampled 12:35 5-26-23 Purged/Sampled By A.N
 Sample Method Bail
 Requested Analyses _____
 Comments/Observations low water flow after 5 gals.

Well Casing Volumes
 2" diameter = 0.17 gal/ft 4" diameter = 0.66 gal/ft 5" diameter = 1.02 gal/ft 6" diameter = 1.50 gal/ft

MONITOR WELL DEVELOPMENT FIELD FORM

FLUID LEVEL DATA

Well ID DAD-24 Date Gauged 6-1-23
 Site DAD's Time Gauged 8:55
 Depth to PSH _____ feet Well Diameter 2 inches
 Depth to Water 67.69 feet Height of Fluid Column 62.86 feet
 Total Depth 130.55 feet Volume in Well 10.686 gallons
 (3 Well Volumes = 32.05 gallons)

GROUNDWATER SAMPLING DATA

Time/date Purged 9:06 6-1-23 Purged Method Pump

Time	Purge-Vol (gal)	Cumul Purge Vol (gal)	Temp (°C)	SpC (µs/cm)	pH	ORP (mV)	DO (mg/L)
9:33	10	10	23.1	4270	7.43	156	2.30
9:56	10	20	24.0	4296	7.27		
10:32	13	33	24.4	4327	7.21		

Actual Purge Volume 38 gals Field Measurements stabilized within ± 10% Y
 Time/Date Sampled 10:56 6-1-23 Purged/Sampled By A.N
 Sample Method Pump
 Requested Analyses _____
 Comments/Observations slow water flow.

Well Casing Volumes
 2" diameter = 0.17 gal/ft 4" diameter = 0.66 gal/ft 5" diameter = 1.02 gal/ft 6" diameter = 1.50 gal/ft

MONITOR WELL DEVELOPMENT FIELD FORM

FLUID LEVEL DATA

Well ID DAD-25 Date Gauged 6-5-23
 Site DAD's Time Gauged 13:21

Depth to PSH _____ feet Well Diameter 2 inches
 Depth to Water 67.50 feet Height of Fluid Column 9.70 feet
 Total Depth 77.20 feet Volume in Well 1.649 gallons
 (3 Well Volumes = 4.94 gallons)

GROUNDWATER SAMPLING DATA

Time/date Purged 13:26 6-5-23 Purged Method Bail

Time	Purge Vol (gal)	Cumul Purge Vol (gal)	Temp (°C)	SpC (µs/cm)	pH	ORP (mV)	DO (mg/L)
13:38	1.50	1.50	23.7	3773	7.42	130	2.83
13:49	1.50	3	23.1	3291	7.34		
14:05	2	5	23.5	3328	7.25		

Actual Purge Volume 8 gals Field Measurements stabilized within ± 10% Y
 Time/Date Sampled 14:28 6-5-23 Purged/Sampled By A.N
 Sample Method Bail
 Requested Analyses _____
 Comments/Observations water flow not consistent

Well Casing Volumes
 2" diameter = 0.17 gal/ft 4" diameter = 0.66 gal/ft 5" diameter = 1.02 gal/ft 6" diameter = 1.50 gal/ft

MONITOR WELL DEVELOPMENT FIELD FORM

FLUID LEVEL DATA

Well ID DAD-26 Date Gauged 6-6-23
 Site DAD'S Time Gauged 12:36

Depth to PSH _____ feet Well Diameter 2 inches
 Depth to Water 49.80 feet Height of Fluid Column 12.80 feet
 Total Depth 62.60 feet Volume in Well 2.176 gallons
 (3 Well Volumes = 6.52 gallons)

GROUNDWATER SAMPLING DATA

Time/date Purged 12:45 6-6-23 Purged Method Bad Pump

Time	Purge-Vol (gal)	Cumul Purge Vol (gal)	Temp (°C)	SpC (µs/cm)	pH	ORP (mV)	DO (mg/L)
12:56	2	2	24.1	3361	7.31	133	2.53
13:16	2	4	23.9	3373	7.23		
13:32	3	7	23.7	3286	7.19		

Actual Purge Volume 9 gals Field Measurements stabilized within ± 10% Y
 Time/Date Sampled 13:45 6-6-23 Purged/Sampled By A.N.
 Sample Method Pump
 Requested Analyses _____
 Comments/Observations _____

Well Casing Volumes
 2" diameter = 0.17 gal/ft 4" diameter = 0.66 gal/ft 5" diameter = 1.02 gal/ft 6" diameter = 1.50 gal/ft

MONITOR WELL DEVELOPMENT FIELD FORM

FLUID LEVEL DATA

Well ID DAD-27 Date Gauged 6-6-23
 Site DAD'S Time Gauged 14:40

Depth to PSH _____ feet Well Diameter 2 inches
 Depth to Water 27.67 feet Height of Fluid Column 9.98 feet
 Total Depth 37.65 feet Volume in Well 1.696 gallons
 (3 Well Volumes = 5.08 gallons)

GROUNDWATER SAMPLING DATA

Time/date Purged 14:45 6-6-23 Purged Method Bail

Time	Purge Vol (gal)	Cumul Purge Vol (gal)	Temp (°C)	SpC (µs/cm)	pH	ORP (mV)	DO (mg/L)
14:57	2	2	22.6	3028	7.02	138	2.23
15:13	2	4	22.2	3042	7.16		
15:25	1.25	5.25	22.4	3065	7.22		

Actual Purge Volume 7.50 gals Field Measurements stabilized within ± 10% Y
 Time/Date Sampled 15:46 6-6-23 Purged/Sampled By A.N
 Sample Method Bail
 Requested Analyses _____
 Comments/Observations _____

Well Casing Volumes
 2" diameter = 0.17 gal/ft 4" diameter = 0.66 gal/ft 5" diameter = 1.02 gal/ft 6" diameter = 1.50 gal/ft

MONITOR WELL DEVELOPMENT FIELD FORM

FLUID LEVEL DATA

Well ID 692-02 Date Gauged 5-18-23
 Site DeLoro Time Gauged 12:52

Depth to PSH _____ feet Well Diameter 4 inches
 Depth to Water 60.37 feet Height of Fluid Column 5.78 feet
 Total Depth 66.15 feet Volume in Well 3.814 gallons
 (3 Well Volumes = 11.44 gallons)

GROUNDWATER SAMPLING DATA

Time/date Purged 12:58 5-18-23 Purged Method Pump

Time	Purge Vol (gal)	Cumul Purge Vol (gal)	Temp (°C)	SpC (µs/cm)	pH	ORP (mV)	DO (mg/L)
13:15	5	5	23.7	2597	7.59	123	1.90
13:28	5	10	23.9	2604	7.45		
13:35	2	12	23.7	2625	7.33		
13:38	25	12.25	23.8	2618	7.29		

Actual Purge Volume 17 gals Field Measurements stabilized within ± 10% Y
 Time/Date Sampled 13:53 5-18-23 Purged/Sampled By A.N
 Sample Method Pump
 Requested Analyses _____
 Comments/Observations _____

Well Casing Volumes
 2" diameter = 0.17 gal/ft 4" diameter = 0.66 gal/ft 5" diameter = 1.02 gal/ft 6" diameter = 1.50 gal/ft

MONITOR WELL DEVELOPMENT FIELD FORM

FLUID LEVEL DATA

Well ID 692-04 Date Gauged 5-18-23
 Site DeLoro Time Gauged 12:35
 Depth to PSH _____ feet Well Diameter 4 inches
 Depth to Water Dry feet Height of Fluid Column _____ feet
 Total Depth 60.58 feet Volume in Well _____ gallons
 (3 Well Volumes = _____ gallons)

GROUNDWATER SAMPLING DATA

Time/date Purged _____ Purged Method _____

Time	Purge Vol (gal)	Cumul Purge Vol (gal)	Temp (°C)	SpC (µs/cm)	pH	ORP (mV)	DO (mg/L)

Actual Purge Volume _____ gals Field Measurements stabilized within ± 10% _____
 Time/Date Sampled _____ Purged/Sampled By _____
 Sample Method _____
 Requested Analyses _____
 Comments/Observations Dry well

Well Casing Volumes
 2" diameter = 0.17 gal/ft 4" diameter = 0.66 gal/ft 5" diameter = 1.02 gal/ft 6" diameter = 1.50 gal/ft

MONITOR WELL DEVELOPMENT FIELD FORM

FLUID LEVEL DATA

Well ID 692-05 Date Gauged 5-23-23
 Site Del Oro Time Gauged 12:06

Depth to PSH _____ feet Well Diameter 4 inches
 Depth to Water 81.00 feet Height of Fluid Column 6.50 feet
 Total Depth 87.50 feet Volume in Well 4.29 gallons
 (3 Well Volumes = 12.87 gallons)

GROUNDWATER SAMPLING DATA

Time/date Purged 12:11 5-23-23 Purged Method Pump

Time	Purge Vol (gal)	Cumul Purge Vol (gal)	Temp (°C)	SpC (µs/cm)	pH	ORP (mV)	DO (mg/L)
12:25	5	5	22.9	2421	7.60	122	1.80
12:37	5	10	22.5	2438	7.41		
12:52	3	13	22.2	2470	7.26		

Actual Purge Volume 18 gals Field Measurements stabilized within ± 10% Y
 Time/Date Sampled 13:10 5-23-23 Purged/Sampled By A.N
 Sample Method Pump
 Requested Analyses _____
 Comments/Observations _____

Well Casing Volumes
 2" diameter = 0.17 gal/ft 4" diameter = 0.66 gal/ft 5" diameter = 1.02 gal/ft 6" diameter = 1.50 gal/ft

MONITOR WELL DEVELOPMENT FIELD FORM

FLUID LEVEL DATA

Well ID 692-06 Date Gauged 5-23-23
 Site Del Oro Time Gauged 13:20

Depth to PSH _____ feet Well Diameter 4 inches
 Depth to Water 84.15 feet Height of Fluid Column 6.05 feet
 Total Depth 90.20 feet Volume in Well 3.993 gallons
 (3 Well Volumes = 11.97 gallons)

GROUNDWATER SAMPLING DATA

Time/date Purged 13:25 5-23-23 Purged Method Pump

Time	Purge Vol (gal)	Cumul Purge Vol (gal)	Temp (°C)	SpC (µs/cm)	pH	ORP (mV)	DO (mg/L)
13:40	5	5	24.1	2334	7.51	141	1.73
13:56	5	10	24.0	2311	7.42		
14:12	2	12	23.7	2295	7.32		
14:15	.25	12.25	24.1	2272	7.29		

Actual Purge Volume 17 gals Field Measurements stabilized within ± 10% y
 Time/Date Sampled 14:36 5-23-23 Purged/Sampled By A.N
 Sample Method Pump
 Requested Analyses _____
 Comments/Observations _____

Well Casing Volumes

2" diameter = 0.17 gal/ft 4" diameter = 0.66 gal/ft 5" diameter = 1.02 gal/ft 6" diameter = 1.50 ga/ft

MONITOR WELL DEVELOPMENT FIELD FORM

FLUID LEVEL DATA

Well ID 692-07 Date Gauged 5-24-23
 Site DeLoro Time Gauged 9:45

Depth to PSH _____ feet Well Diameter 4 inches
 Depth to Water 76.32 feet Height of Fluid Column 1.33 feet
 Total Depth 77.65 feet Volume in Well 0.8778 gallons
 (3 Well Volumes = 2.63 gallons)

GROUNDWATER SAMPLING DATA

Time/date Purged 9:50 5-24-23 Purged Method Bail

Time	Purge Vol (gal)	Cumul Purge Vol (gal)	Temp (°C)	SpC (µs/cm)	pH	ORP (mV)	DO (mg/L)
10:00	1	1	22.4	2501	7.58	141	1.86
10:10	1	2	22.3	2521	7.41		
10:20	1	3	22.5	2490	7.32		

Actual Purge Volume 6 gals Field Measurements stabilized within ± 10% Y
 Time/Date Sampled 10:51 5-24-23 Purged/Sampled By A.N
 Sample Method Bail
 Requested Analyses _____
 Comments/Observations _____

Well Casing Volumes
 2" diameter = 0.17 gal/ft 4" diameter = 0.66 gal/ft 5" diameter = 1.02 gal/ft 6" diameter = 1.50 gal/ft

MONITOR WELL DEVELOPMENT FIELD FORM

FLUID LEVEL DATA

Well ID 692-08 Date Gauged 5-24-23
 Site Del Oro Time Gauged 13:03
 Depth to PSH _____ feet Well Diameter 4 inches
 Depth to Water 69.97 feet Height of Fluid Column 7.18 feet
 Total Depth 77.15 feet Volume in Well 4.738 gallons
 (3 Well Volumes = 14.21 gallons)

GROUNDWATER SAMPLING DATA

Time/date Purged 13:09 5-24-23 Purged Method Pump

Time	Purge Vol (gal)	Cumul Purge Vol (gal)	Temp (°C)	SpC (µs/cm)	pH	ORP (mV)	DO (mg/L)
13:35	5	5	26.8	2216	7.19	52	1.62
14:05	5	10	26.4	2164	7.38		
14:30	5	15	30.1	2177	7.31		

Actual Purge Volume 20 gals Field Measurements stabilized within ± 10% Y
 Time/Date Sampled 15:05 5-24-23 Purged/Sampled By A.N
 Sample Method Pump
 Requested Analyses _____
 Comments/Observations Very slow water flow.

Well Casing Volumes
 2" diameter = 0.17 gal/ft 4" diameter = 0.66 gal/ft 5" diameter = 1.02 gal/ft 6" diameter = 1.50 gal/ft

MONITOR WELL DEVELOPMENT FIELD FORM

FLUID LEVEL DATA

Well ID 692-09 Date Gauged 5-23-23
 Site Del Oro Time Gauged 10:00

Depth to PSH _____ feet Well Diameter 4 inches
 Depth to Water 85.33 feet Height of Fluid Column 5.77 feet
 Total Depth 91.10 feet Volume in Well 3.808 gallons

(3 Well Volumes = 11.42 gallons)

GROUNDWATER SAMPLING DATA

Time/date Purged 10:09 5-23-23 Purged Method Pump

Time	Purge Vol (gal)	Cumul Purge Vol (gal)	Temp (°C)	SpC (µs/cm)	pH	ORP (mV)	DO (mg/L)
10:22	5	5	23.1	2250	7.77	147	1.66
10:45	5	10	24.7	2263	7.54		
11:19	2	12	24.0	2300	7.30		

Actual Purge Volume 17 gals Field Measurements stabilized within ± 10% Y

Time/Date Sampled 11:47 5-23-23 Purged/Sampled By A.N

Sample Method Pump

Requested Analyses _____

Comments/Observations water flow not consistent.

Well Casing Volumes

2" diameter = 0.17 gal/ft 4" diameter = 0.66 gal/ft 5" diameter = 1.02 gal/ft 6" diameter = 1.50 gal/ft

MONITOR WELL DEVELOPMENT FIELD FORM

FLUID LEVEL DATA

Well ID 692-10 Date Gauged 5-24-23
 Site Del Oro Time Gauged 10:58
 Depth to PSH _____ feet Well Diameter 2 inches
 Depth to Water 75.24 feet Height of Fluid Column 2.66 feet
 Total Depth 77.90 feet Volume in Well 0.4522 gallons
 (3 Well Volumes = 1.35 gallons)

GROUNDWATER SAMPLING DATA

Time/date Purged 11:04 5-24-23 Purged Method Bail

Time	Purge-Vol (gal)	Cumul Purge Vol (gal)	Temp (°C)	SpC (µs/cm)	pH	ORP (mV)	DO (mg/L)
11:16	.50	.50	23.9	2784	6.86	123	2.07
11:26	.50	1	23.2	2796	7.10		
11:38	.50	1.50	24.2	2764	7.25		

Actual Purge Volume 3 gals Field Measurements stabilized within ± 10% Y
 Time/Date Sampled 12:00 5-24-23 Purged/Sampled By A.W.
 Sample Method Bail
 Requested Analyses _____
 Comments/Observations Very slow water flow, slow water recovery.

Well Casing Volumes
 2" diameter = 0.17 gal/ft 4" diameter = 0.66 gal/ft 5" diameter = 1.02 gal/ft 6" diameter = 1.50 gal/ft

MONITOR WELL DEVELOPMENT FIELD FORM

FLUID LEVEL DATA

Well ID EW-01 Date Gauged 5-19-23
 Site Del Oro Time Gauged 13:50

Depth to PSH _____ feet Well Diameter 4 inches
 Depth to Water 7 feet Height of Fluid Column 7 feet
 Total Depth _____ feet Volume in Well _____ gallons

(3 Well Volumes = 15 gallons)

GROUNDWATER SAMPLING DATA

Time/date Purged 13:55 5-19-23 Purged Method Pump

Time	Purge Vol (gal)	Cumul Purge Vol (gal)	Temp (°C)	SpC (µs/cm)	pH	ORP (mV)	DO (mg/L)
14:07	5	5	23.8	6121	7.41	122	1.87
14:19	5	10	23.1	674	7.36		
14:32	5	15	23.2	6058	7.24		

Actual Purge Volume 20 gals Field Measurements stabilized within ± 10% Y

Time/Date Sampled 14:53 5-19-23 Purged/Sampled By A.N

Sample Method Pump

Requested Analyses _____

Comments/Observations _____

Well Casing Volumes

2" diameter = 0.17 gal/ft 4" diameter = 0.66 gal/ft 5" diameter = 1.02 gal/ft 6" diameter = 1.50 ga/ft

MONITOR WELL DEVELOPMENT FIELD FORM

FLUID LEVEL DATA

Well ID EW-02 Date Gauged 5-19-23
 Site D-1010 Time Gauged 11:00
 Depth to PSH _____ feet Well Diameter 4 inches
 Depth to Water — feet Height of Fluid Column — feet
 Total Depth — feet Volume in Well — gallons
 (3 Well Volumes = 15 gallons)

GROUNDWATER SAMPLING DATA

Time/date Purged 11:05 5-19-23 Purged Method Pump

Time	Purge Vol (gal)	Cumul Purge Vol (gal)	Temp (°C)	SpC (µs/cm)	pH	ORP (mV)	DO (mg/L)
11:20	5	5	24.1	4994	7.44	158	1.98
11:35	5	10	23.4	4982	7.21		
11:50	5	15	23.4	4973	7.19		

Actual Purge Volume 20 gals Field Measurements stabilized within ± 10% Y

Time/Date Sampled 12:00 5-19-23 Purged/Sampled By AW

Sample Method Pump

Requested Analyses _____

Comments/Observations Pump stopped for a couple of mins around 10 gals then continue.

Well Casing Volumes
 2" diameter = 0.17 gal/ft 4" diameter = 0.66 gal/ft 5" diameter = 1.02 gal/ft 6" diameter = 1.50 gal/ft

MONITOR WELL DEVELOPMENT FIELD FORM

FLUID LEVEL DATA

Well ID EW-01 Date Gauged 5-18-23
 Site Del Oro Time Gauged
 Depth to PSH feet Well Diameter 4 inches
 Depth to Water feet Height of Fluid Column feet
 Total Depth feet Volume in Well gallons
 (3 Well Volumes = 15 gallons)

GROUNDWATER SAMPLING DATA

Time/date Purged 14:29 5-18-23 Purged Method Pump

Time	Purge Vol (gal)	Cumul Purge Vol (gal)	Temp (°C)	SpC (µs/cm)	pH	ORP (mV)	DO (mg/L)
14:46	5	5	24.0	2557	7.85	153	1.90
15:11	5	10	24.2	2575	7.62		
15:40	5	15	24.4	2515	7.38		
15:41	25	15.25	24.3	2487	7.35		

Actual Purge Volume 20 gals Field Measurements stabilized within ± 10% Y
 Time/Date Sampled 16:00 5-18-23 Purged/Sampled By A.N
 Sample Method Pump
 Requested Analyses
 Comments/Observations Pump would stop pumping water, then flow would continue coming out.

Well Casing Volumes
 2" diameter = 0.17 gal/ft 4" diameter = 0.66 gal/ft 5" diameter = 1.02 gal/ft 6" diameter = 1.50 gal/ft

MONITOR WELL DEVELOPMENT FIELD FORM

FLUID LEVEL DATA

Well ID EW-05 Date Gauged 5-19-23
 Site Del Oro Time Gauged 9:57
 Depth to PSH _____ feet Well Diameter 4 inches
 Depth to Water 1 feet Height of Fluid Column _____ feet
 Total Depth 1 feet Volume in Well _____ gallons
 (3 Well Volumes = 15 gallons)

GROUNDWATER SAMPLING DATA

Time/date Purged 12:17 5-19-23 Purged Method Pump

Time	Purge Vol (gal)	Cumul Purge Vol (gal)	Temp (°C)	SpC (µs/cm)	pH	ORP (mV)	DO (mg/L)
12:32	5	5	23.3	2935	7.32	154	1.91
12:43	5	10	23.4	2886	7.41		
12:58	5	15	23.5	2863	7.25		

Actual Purge Volume 20 gals Field Measurements stabilized within ± 10% Y

Time/Date Sampled 13:13 5-19-23 Purged/Sampled By A.W

Sample Method Pump

Requested Analyses _____

Comments/Observations NO water coming out of pump. Turn on & off switch couple of times to reset, still not working. Came back @ 12:10. Javier from Dairy stated there was a loose cable.

Well Casing Volumes
 2" diameter = 0.17 gal/ft 4" diameter = 0.66 gal/ft 5" diameter = 1.02 gal/ft 6" diameter = 1.50 gal/ft

MONITOR WELL DEVELOPMENT FIELD FORM

FLUID LEVEL DATA

Well ID 624-01 Date Gauged 5-12-23
 Site Dominquez 1 Time Gauged 10:58

Depth to PSH _____ feet Well Diameter 4 inches
 Depth to Water 30.71 feet Height of Fluid Column 16.10 feet
 Total Depth 46.81 feet Volume in Well 10.626 gallons
 (3 Well Volumes = 31.87 gallons)

GROUNDWATER SAMPLING DATA

Time/date Purged 11:07 5-12-23 Purged Method Pump

Time	Purge-Vol (gal)	Cumul Purge Vol (gal)	Temp (°C)	SpC (µs/cm)	pH	ORP (mV)	DO (mg/L)
<u>11:17</u>	<u>10</u>	<u>10</u>	<u>20.9</u>	<u>4261</u>	<u>7.43</u>	<u>157</u>	<u>1.31</u>
<u>11:29</u>	<u>10</u>	<u>20</u>	<u>21.0</u>	<u>4285</u>	<u>7.31</u>		
<u>11:42</u>	<u>12</u>	<u>32</u>	<u>21.2</u>	<u>4321</u>	<u>7.23</u>		

Actual Purge Volume 38 gals Field Measurements stabilized within ± 10% Y
 Time/Date Sampled 11:50 5-12-23 Purged/Sampled By A.N
 Sample Method Pump
 Requested Analyses _____
 Comments/Observations _____

Well Casing Volumes
 2" diameter = 0.17 gal/ft 4" diameter = 0.66 gal/ft 5" diameter = 1.02 gal/ft 6" diameter = 1.50 gal/ft

MONITOR WELL DEVELOPMENT FIELD FORM

FLUID LEVEL DATA

Well ID 624-02 Date Gauged 5-12-23
 Site Dominquez 1 Time Gauged 12:42
 Depth to PSH _____ feet Well Diameter 4 inches
 Depth to Water 22.30 feet Height of Fluid Column 15.10 feet
 Total Depth 37.40 feet Volume in Well 9.966 gallons
 (3 Well Volumes = 29.89 gallons)

GROUNDWATER SAMPLING DATA

Time/date Purged 12:48 5-12-23 Purged Method Pump

Time	Purge Vol (gal)	Cumul Purge Vol (gal)	Temp (°C)	SpC (µs/cm)	pH	ORP (mV)	DO (mg/L)
13:09	10	10	21.4	4230	8.09	107	2.82
13:19	10	20	20.9	4187	7.70		
13:34	10	30	20.6	4219	7.52		
13:35	25	30.25	20.7	4222	7.39		

Actual Purge Volume 35 gals Field Measurements stabilized within ± 10% y
 Time/Date Sampled 13:43 5-12-23 Purged/Sampled By A.N
 Sample Method Pump
 Requested Analyses _____
 Comments/Observations _____

Well Casing Volumes

2" diameter = 0.17 gal/ft 4" diameter = 0.66 gal/ft 5" diameter = 1.02 gal/ft 6" diameter = 1.50 gal/ft

MONITOR WELL DEVELOPMENT FIELD FORM

FLUID LEVEL DATA

Well ID 624-09 Date Gauged 5-11-23
 Site Dominquez 1 Time Gauged 13:35
 Depth to PSH _____ feet Well Diameter 2 inches
 Depth to Water 25.18 feet Height of Fluid Column 7.62 feet
 Total Depth 32.80 feet Volume in Well 1.295 gallons
 (3 Well Volumes = 3.88 gallons)

GROUNDWATER SAMPLING DATA

Time/date Purged 13:40 5-11-23 Purged Method Bail

Time	Purge Vol (gal)	Cumul Purge Vol (gal)	Temp (°C)	SpC (µs/cm)	pH	ORP (mV)	DO (mg/L)
13:52	1	1	21.1	2318	7.60	56	1.70
14:04	1	2	20.8	2330	7.46		
14:23	2	4	21.3	2297	7.31		
14:26	.25	4.25	21.0	2273	7.27		

Actual Purge Volume 6 gals Field Measurements stabilized within ± 10% Y
 Time/Date Sampled 14:48 5-11-23 Purged/Sampled By A.N
 Sample Method Bail
 Requested Analyses _____
 Comments/Observations _____

Well Casing Volumes
 2" diameter = 0.17 gal/ft 4" diameter = 0.66 gal/ft 5" diameter = 1.02 gal/ft 6" diameter = 1.50 gal/ft

MONITOR WELL DEVELOPMENT FIELD FORM

FLUID LEVEL DATA

Well ID 624-10 Date Gauged 5-11-23
 Site Dominquez 1 Time Gauged 15:10

Depth to PSH _____ feet Well Diameter 2 inches
 Depth to Water 25.69 feet Height of Fluid Column 11.66 feet
 Total Depth 37.35 feet Volume in Well 1.982 gallons
 (3 Well Volumes = 5.94 gallons)

GROUNDWATER SAMPLING DATA

Time/date Purged 15:18 5-11-23 Purged Method Pump

Time	Purge Vol (gal)	Cumul Purge Vol (gal)	Temp (°C)	SpC (µs/cm)	pH	ORP (mV)	DO (mg/L)
15:28	2	2	20.2	4446	7.88	77	1.43
15:34	2	4	19.4	4636	7.51		
15:41	2	6	19.5	4560	7.35		
15:44	2.25	6.25	19.4	4581	7.33		

Actual Purge Volume 9 gals Field Measurements stabilized within ± 10% Y
 Time/Date Sampled 15:56 5-11-23 Purged/Sampled By A.N
 Sample Method Pump
 Requested Analyses _____
 Comments/Observations _____

Well Casing Volumes
 2" diameter = 0.17 gal/ft 4" diameter = 0.66 gal/ft 5" diameter = 1.02 gal/ft 6" diameter = 1.50 gal/ft

MONITOR WELL DEVELOPMENT FIELD FORM

FLUID LEVEL DATA

Well ID 624-11
 Site Dominquez 1

Date Gauged 5-12-23
 Time Gauged 9:50

Depth to PSH _____ feet Well Diameter 2 inches
 Depth to Water 56.10 feet Height of Fluid Column 12.77 feet
 Total Depth 68.87 feet Volume in Well 2.170 gallons
 (3 Well Volumes = 6.51 gallons)

GROUNDWATER SAMPLING DATA

Time/date Purged 9:56 5-12-23 Purged Method Pump

Time	Purge Vol (gal)	Cumul Purge Vol (gal)	Temp (°C)	SpC (µs/cm)	pH	ORP (mV)	DO (mg/L)
10:05	2	2	21.6	5721	7.28	154	2.55
10:15	2	4	21.5	5746	7.20		
10:35	3	7	21.7	5738	7.19		

Actual Purge Volume 10 gals Field Measurements stabilized within ± 10% Y

Time/Date Sampled 10:52 5-12-23 Purged/Sampled By A.N

Sample Method Pump

Requested Analyses _____

Comments/Observations _____

Well Casing Volumes

2" diameter = 0.17 gal/ft 4" diameter = 0.66 gal/ft 5" diameter = 1.02 gal/ft 6" diameter = 1.50 gal/ft

MONITOR WELL DEVELOPMENT FIELD FORM

FLUID LEVEL DATA

Well ID 42-03 Date Gauged 5-9-23
 Site Dominquez 2 Time Gauged 9:15
 Depth to PSH _____ feet Well Diameter 4 inches
 Depth to Water 87.31 feet Height of Fluid Column 9.90 feet
 Total Depth 97.21 feet Volume in Well 6.534 gallons
 (3 Well Volumes = 19.60 gallons)

GROUNDWATER SAMPLING DATA

Time/date Purged 9:20 5-9-23 Purged Method Pump

Time	Purge Vol (gal)	Cumul Purge Vol (gal)	Temp (°C)	SpC (µs/cm)	pH	ORP (mV)	DO (mg/L)
9:37	6	6	25.3	5075	7.39	157	2.83
9:48	6	12	25.0	5051	7.33		
10:03	8	20	25.4	5034	7.26		

Actual Purge Volume 25 gals Field Measurements stabilized within ± 10% Y
 Time/Date Sampled 10:19 5-9-23 Purged/Sampled By A.N
 Sample Method Pump
 Requested Analyses _____
 Comments/Observations _____

Well Casing Volumes
 2" diameter = 0.17 gal/ft 4" diameter = 0.66 gal/ft 5" diameter = 1.02 gal/ft 6" diameter = 1.50 gal/ft

MONITOR WELL DEVELOPMENT FIELD FORM

FLUID LEVEL DATA

Well ID 42-02 Date Gauged 5-10-23
 Site Dominique 2 Time Gauged 9:19

Depth to PSH _____ feet Well Diameter 4 inches
 Depth to Water 30.98 feet Height of Fluid Column 34.32 feet
 Total Depth 65.30 feet Volume in Well 22.651 gallons
 (3 Well Volumes = 67.95 gallons)

GROUNDWATER SAMPLING DATA

Time/date Purged 9:25 5-10-23 Purged Method Pump

Time	Purge Vol (gal)	Cumul Purge Vol (gal)	Temp (°C)	SpC (µs/cm)	pH	ORP (mV)	DO (mg/L)
9:58	25	25	20.2	3986	7.48	152	2.07
10:32	25	50	20.5	3977	7.36		
11:00	18	68	20.1	3961	7.28		

Actual Purge Volume 73 gals Field Measurements stabilized within ± 10% Y
 Time/Date Sampled 11:30 5-10-23 Purged/Sampled By A.N
 Sample Method Pump
 Requested Analyses _____
 Comments/Observations _____

Well Casing Volumes
 2" diameter = 0.17 gal/ft 4" diameter = 0.66 gal/ft 5" diameter = 1.02 gal/ft 6" diameter = 1.50 gal/ft

MONITOR WELL DEVELOPMENT FIELD FORM

FLUID LEVEL DATA

Well ID 42-06 Date Gauged 5-9-23
 Site Dominguez 2 Time Gauged 13:20
 Depth to PSH _____ feet Well Diameter 4 inches
 Depth to Water 37.16 feet Height of Fluid Column 4.39 feet
 Total Depth 41.55 feet Volume in Well 2.897 gallons
 (3 Well Volumes = 8.69 gallons)

GROUNDWATER SAMPLING DATA

Time/date Purged 13:24 5-9-23 Purged Method Pump

Time	Purge Vol (gal)	Cumul Purge Vol (gal)	Temp (°C)	SpC (µs/cm)	pH	ORP (mV)	DO (mg/L)
13:39	3	3	23.1	3699	7.60	137	2.84
13:55	3	6	21.6	3683	7.41		
14:10	3	9	21.2	3674	7.36		
14:12	25	9.25	21.7	3658	7.30		

Actual Purge Volume 13 gals Field Measurements stabilized within ± 10% Y
 Time/Date Sampled 14:35 5-9-23 Purged/Sampled By A.N
 Sample Method Pump
 Requested Analyses _____
 Comments/Observations _____

Well Casing Volumes

2" diameter = 0.17 gal/ft 4" diameter = 0.66 gal/ft 5" diameter = 1.02 gal/ft 6" diameter = 1.50 ga/ft

MONITOR WELL DEVELOPMENT FIELD FORM

FLUID LEVEL DATA

Well ID 42-08 Date Gauged 5-10-23
 Site Dominguez 2 Time Gauged 11:50

Depth to PSH _____ feet Well Diameter 4 inches
 Depth to Water 31.94 feet Height of Fluid Column 3.16 feet
 Total Depth 35-10 feet Volume in Well 2.085 gallons
 (3 Well Volumes = 6.25 gallons)

GROUNDWATER SAMPLING DATA

Time/date Purged 11:56 5-10-23 Purged Method Pump

Time	Purge Vol (gal)	Cumul Purge Vol (gal)	Temp (°C)	SpC (µs/cm)	pH	ORP (mV)	DO (mg/L)
<u>12:21</u>	<u>2</u>	<u>2</u>	<u>23.8</u>	<u>2860</u>	<u>7.59</u>	<u>256</u>	<u>2.16</u>
<u>12:45</u>	<u>2</u>	<u>4</u>	<u>24.0</u>	<u>2933</u>	<u>7.30</u>		
<u>13:17</u>	<u>2.50</u>	<u>6.50</u>	<u>24.2</u>	<u>3015</u>	<u>7.25</u>		

Actual Purge Volume 9 gals Field Measurements stabilized within ± 10% Y
 Time/Date Sampled 13:26 5-10-23 Purged/Sampled By A.N
 Sample Method Pump
 Requested Analyses _____
 Comments/Observations Very slow water flow.

Well Casing Volumes
 2" diameter = 0.17 gal/ft 4" diameter = 0.66 gal/ft 5" diameter = 1.02 gal/ft 6" diameter = 1.50 gal/ft

MONITOR WELL DEVELOPMENT FIELD FORM

FLUID LEVEL DATA

Well ID 42-10 Date Gauged 5-11-23
 Site Dominique 2 Time Gauged 11:00
 Depth to PSH _____ feet Well Diameter 4 inches
 Depth to Water 118.30 feet Height of Fluid Column 5.34 feet
 Total Depth 123.64 feet Volume in Well 3.524 gallons
 (3 Well Volumes = 10.57 gallons)

GROUNDWATER SAMPLING DATA

Time/date Purged 11:06 5-11-23 Purged Method Pump

Time	Purge Vol (gal)	Cumul Purge Vol (gal)	Temp (°C)	SpC (µs/cm)	pH	ORP (mV)	DO (mg/L)
11:32	4	4	24.2	2676	7.70	110	2.00
11:55	4	8	26.0	2584	7.48		
12:20	3	11	29.3	2640	7.36		
12:22	25	11.25	29.6	2633	7.30		

Actual Purge Volume 15 gals Field Measurements stabilized within ± 10% Y
 Time/Date Sampled 12:53 5-11-23 Purged/Sampled By A.N
 Sample Method Pump
 Requested Analyses _____
 Comments/Observations slow water flow

Well Casing Volumes
 2" diameter = 0.17 gal/ft 4" diameter = 0.66 gal/ft 5" diameter = 1.02 gal/ft 6" diameter = 1.50 gal/ft

MONITOR WELL DEVELOPMENT FIELD FORM

FLUID LEVEL DATA

Well ID 42-11 Date Gauged 5-10-23
 Site Dominique 2 Time Gauged 14:27

Depth to PSH _____ feet Well Diameter 4 inches
 Depth to Water 129.02 feet Height of Fluid Column 4.48 feet
 Total Depth 133.50 feet Volume in Well 2.956 gallons
 (3 Well Volumes = 8.87 gallons)

GROUNDWATER SAMPLING DATA

Time/date Purged 14:34 5-10-23 Purged Method Pump

Time	Purge Vol (gal)	Cumul Purge Vol (gal)	Temp (°C)	SpC (µs/cm)	pH	ORP (mV)	DO (mg/L)
14:46	3	3	24.2	2316	8.00	110	1.72
14:55	3	6	25.3	2325	7.73		
15:15	3	9	25.2	2305	7.51		
15:17	.25	9.25	25.6	2286	7.43		

Actual Purge Volume 12 gals Field Measurements stabilized within ± 10% Y
 Time/Date Sampled 15:42 5-10-23 Purged/Sampled By A.N
 Sample Method Pump
 Requested Analyses _____
 Comments/Observations Very slow water flow.

Well Casing Volumes
 2" diameter = 0.17 gal/ft 4" diameter = 0.66 gal/ft 5" diameter = 1.02 gal/ft 6" diameter = 1.50 gal/ft

MONITOR WELL DEVELOPMENT FIELD FORM

FLUID LEVEL DATA

Well ID 42-12 Date Gauged 5-11-23
 Site Dominquez 2 Time Gauged 8:55
 Depth to PSH _____ feet Well Diameter 4 inches
 Depth to Water 135.41 feet Height of Fluid Column 4.07 feet
 Total Depth 139.48 feet Volume in Well 2.686 gallons
 (3 Well Volumes = 8.05 gallons)

GROUNDWATER SAMPLING DATA

Time/date Purged 9:02 5-11-23 Purged Method Pump

Time	Purge-Vol (gal)	Cumul Purge Vol (gal)	Temp (°C)	SpC (µs/cm)	pH	ORP (mV)	DO (mg/L)
9:16	2	2	22.6	1797	7.57	150	1.30
9:39	3	5	25.0	1783	7.38		
10:04	3.25	8.25	26.1	1765	7.30		
10:07	.25	8.50	26.4	1762	7.28		

Actual Purge Volume 12.5 gals Field Measurements stabilized within ± 10% Y
 Time/Date Sampled 10:41 5-11-23 Purged/Sampled By A.N
 Sample Method Pump
 Requested Analyses _____
 Comments/Observations slow water flow

Well Casing Volumes
 2" diameter = 0.17 gal/ft 4" diameter = 0.66 gal/ft 5" diameter = 1.02 gal/ft 6" diameter = 1.50 gal/ft

MONITOR WELL DEVELOPMENT FIELD FORM

FLUID LEVEL DATA

Well ID 42-13 Date Gauged 5-9-23
 Site Dominquez 2 Time Gauged 10:36
 Depth to PSH _____ feet Well Diameter 4 inches
 Depth to Water 60.00 feet Height of Fluid Column 7.60 feet
 Total Depth 67.60 feet Volume in Well 5.016 gallons
 (3 Well Volumes = 15.04 gallons)

GROUNDWATER SAMPLING DATA

Time/date Purged 10:45 5-9-23 Purged Method Pump

Time	Purge Vol (gal)	Cumul Purge Vol (gal)	Temp (°C)	SpC (µs/cm)	pH	ORP (mV)	DO (mg/L)
11:08	5	5	23.6	4765	7.48	112	2.62
11:20	5	10	23.0	4631	7.39		
11:45	5.25	15.25	24.1	4524	7.29		

Actual Purge Volume 20 gals Field Measurements stabilized within ± 10% Y
 Time/Date Sampled 12:25 5-9-23 Purged/Sampled By A.N
 Sample Method Pump

Requested Analyses _____

Comments/Observations Very slow water flow and water will not recover quick gauge well and well seemed to be drying out.

Well Casing Volumes

2" diameter = 0.17 gal/ft 4" diameter = 0.66 gal/ft 5" diameter = 1.02 gal/ft 6" diameter = 1.50 gal/ft

MONITOR WELL DEVELOPMENT FIELD FORM

FLUID LEVEL DATA

Well ID 70-01 Date Gauged 5-8-23
 Site Mountain View Time Gauged 11:18
 Depth to PSH _____ feet Well Diameter 4 inches
 Depth to Water 40.04 feet Height of Fluid Column 5.71 feet
 Total Depth 45.75 feet Volume in Well 3.768 gallons
 (3 Well Volumes = 11.30 gallons)

GROUNDWATER SAMPLING DATA

Time/date Purged 11:24 5-8-23 Purged Method Pump

Time	Purge Vol (gal)	Cumul Purge Vol (gal)	Temp (°C)	SpC (µs/cm)	pH	ORP (mV)	DO (mg/L)
11:41	5	5	22.7	4717	7.34	136	2.91
11:53	5	10	23.0	4651	7.29		
12:05	2	12	22.8	4640	7.23		

Actual Purge Volume 16 gals Field Measurements stabilized within ± 10% Y
 Time/Date Sampled 12:20 5-8-23 Purged/Sampled By A.N
 Sample Method Pump
 Requested Analyses _____
 Comments/Observations very slow water flow

Well Casing Volumes
 2" diameter = 0.17 gal/ft 4" diameter = 0.66 gal/ft 5" diameter = 1.02 gal/ft 6" diameter = 1.50 gal/ft

MONITOR WELL DEVELOPMENT FIELD FORM

FLUID LEVEL DATA

Well ID 70-02 Date Gauged 5-8-23
 Site Mountain View Time Gauged 13:15

Depth to PSH _____ feet Well Diameter 4 inches
 Depth to Water 47.62 feet Height of Fluid Column 2.24 feet
 Total Depth 49.86 feet Volume in Well 1.478 gallons
 (3 Well Volumes = 4.43 gallons)

GROUNDWATER SAMPLING DATA

Time/date Purged 13:18 5-8-23 Purged Method Bail

Time	Purge Vol (gal)	Cumul Purge Vol (gal)	Temp (°C)	SpC (µs/cm)	pH	ORP (mV)	DO (mg/L)
13:26	1.50	1.50	28.1	4646	7.80	88	2.54
13:40	1.50	3	31.1	4713	7.54		
13:56	1.50	4.50	29.3	4508	7.33		

Actual Purge Volume 6.50 gals Field Measurements stabilized within ± 10% Y
 Time/Date Sampled 14:10 5-8-23 Purged/Sampled By A.N
 Sample Method Bail
 Requested Analyses _____
 Comments/Observations Very low water flow.

Well Casing Volumes
 2" diameter = 0.17 gal/ft 4" diameter = 0.66 gal/ft 5" diameter = 1.02 gal/ft 6" diameter = 1.50 gal/ft

MONITOR WELL DEVELOPMENT FIELD FORM

FLUID LEVEL DATA

Well ID 70-03 Date Gauged 5-8-23
 Site Mountain View Time Gauged 9:53
 Depth to PSH _____ feet Well Diameter 4 inches
 Depth to Water 59.10 feet Height of Fluid Column 2.55 feet
 Total Depth 61.65 feet Volume in Well 1.683 gallons
 (3 Well Volumes = 5.04 gallons)

GROUNDWATER SAMPLING DATA

Time/date Purged 10:00 5-8-23 Purged Method Bail

Time	Purge Vol (gal)	Cumul Purge Vol (gal)	Temp (°C)	SpC (µs/cm)	pH	ORP (mV)	DO (mg/L)
10:16	2	2	20.8	7375	7.37	156	1.08
10:32	2	4	20.9	7244	7.28		
10:50	1.25	5.25	20.7	7133	7.20		

Actual Purge Volume 6 gals Field Measurements stabilized within ± 10% y
 Time/Date Sampled 10:55 5-8-23 Purged/Sampled By AW
 Sample Method Bail
 Requested Analyses _____
 Comments/Observations low water flow

Well Casing Volumes
 2" diameter = 0.17 gal/ft 4" diameter = 0.66 gal/ft 5" diameter = 1.02 gal/ft 6" diameter = 1.50 gal/ft

MONITOR WELL DEVELOPMENT FIELD FORM

FLUID LEVEL DATA

Well ID 70-04 Date Gauged 5-8-23
 Site Mountain View Time Gauged 14:25

Depth to PSH _____ feet Well Diameter 2 inches
 Depth to Water 38.01 feet Height of Fluid Column 9.81 feet
 Total Depth 47.82 feet Volume in Well 1.667 gallons
 (3 Well Volumes = 5.00 gallons)

GROUNDWATER SAMPLING DATA

Time/date Purged 14:28 5-8-23 Purged Method Bail

Time	Purge Vol (gal)	Cumul Purge Vol (gal)	Temp (°C)	SpC (µs/cm)	pH	ORP (mV)	DO (mg/L)
14:37	2	2	24.3	4536	8.00	20	1.93
14:45	2	4	23.6	4549	7.60		
14:53	1	5	23.8	4480	7.41		
14:56	.25	5.25	23.6	4477	7.34		

Actual Purge Volume 7 gals Field Measurements stabilized within ± 10% Y
 Time/Date Sampled 15:20 5-8-23 Purged/Sampled By A.N
 Sample Method Bail
 Requested Analyses _____
 Comments/Observations _____

Well Casing Volumes
 2" diameter = 0.17 gal/ft 4" diameter = 0.66 gal/ft 5" diameter = 1.02 gal/ft 6" diameter = 1.50 gal/ft

Organ Dairy Mesquite, NM

Field Parameters and Sample Results for Monitoring wells 2nd Quarter 2023

Well ID	Sampling Date	Depth to water (ft)	TDS	Cl (mg/L)	TKN (mg/L)	NO3 (mg/L)	SO4 (mg/L)	EC (μS/cm)	pH	Temp (°C)	DO (mg/L)	ORP (mv)
MW 126-04	5/24/23	38.00	NS	NS	NS	NS	NS	NS	NS	NS	NS	NS
MW 126-05	5/24/23	30.70	NS	NS	NS	NS	NS	NS	NS	NS	NS	NS
MW 126-07	5/24/23	39.63	NS	NS	NS	NS	NS	NS	NS	NS	NS	NS
MW 126-09	5/24/23	82.25	NS	NS	NS	NS	NS	NS	NS	NS	NS	NS
MW 126-12	5/24/23	26.45	2110	400	1.4	3.2	490	3340	7.12	24.3	NS	NS
MW 126-13	5/24/23	46.50	3180	710	<2.0	14	810	4960	6.88	238	NS	NS

NS = Not Sampled

LRG-458S no longer running, barn being torn down.

MONITOR WELL DEVELOPMENT FIELD FORM

FLUID LEVEL DATA

Well ID 257-01 Date Gauged 5-17-23
 Site SUNSET Dairy Time Gauged 14:26

Depth to PSH _____ feet Well Diameter 2 inches
 Depth to Water 22.37 feet Height of Fluid Column 3.48 feet
 Total Depth 25.85 feet Volume in Well 0.5916 gallons

(3 Well Volumes = 1.77 gallons)

GROUNDWATER SAMPLING DATA

Time/date Purged 14:30 5-17-23 Purged Method Bail

Time	Purge Vol (gal)	Cumul Purge Vol (gal)	Temp (°C)	SpC (µs/cm)	pH	ORP (mV)	DO (mg/L)
14:35	.50	.50	21.5	5336	7.40	134	2.28
14:42	.50	1	19.9	5361	7.36		
14:55	1	2	20.2	5394	7.29		

Actual Purge Volume 4 gals Field Measurements stabilized within ± 10% Y
 Time/Date Sampled 15:15 5-17-23 Purged/Sampled By A.N
 Sample Method Bail
 Requested Analyses _____
 Comments/Observations _____

Well Casing Volumes
 2" diameter = 0.17 gal/ft 4" diameter = 0.66 gal/ft 5" diameter = 1.02 gal/ft 6" diameter = 1.50 gal/ft

MONITOR WELL DEVELOPMENT FIELD FORM

FLUID LEVEL DATA

Well ID 257-02 Date Gauged 5-18-23
 Site Sunset Dairy Time Gauged 8:52

Depth to PSH _____ feet Well Diameter 2 inches
 Depth to Water 17.33 feet Height of Fluid Column 3.52 feet
 Total Depth 20.85 feet Volume in Well 0.598 gallons

(3 Well Volumes = 1.79 gallons)

GROUNDWATER SAMPLING DATA

Time/date Purged 9:00 5-18-23 Purged Method Bail

Time	Purge Vol (gal)	Cumul Purge Vol (gal)	Temp (°C)	SpC (µs/cm)	pH	ORP (mV)	DO (mg/L)
9:12	.50	.50	18.5	4235	7.50	160	2.17
9:18	.50	1	18.3	4206	7.37		
9:30	1	2	18.2	4242	7.25		

Actual Purge Volume 5 gals Field Measurements stabilized within ± 10% Y
 Time/Date Sampled 9:46 5-18-23 Purged/Sampled By AN
 Sample Method Bail
 Requested Analyses _____
 Comments/Observations _____

Well Casing Volumes
 2" diameter = 0.17 gal/ft 4" diameter = 0.66 gal/ft 5" diameter = 1.02 gal/ft 6" diameter = 1.50 gal/ft

MONITOR WELL DEVELOPMENT FIELD FORM

FLUID LEVEL DATA

Well ID 257-03 Date Gauged 5-17-23
 Site SUNSET Dairy Time Gauged 13:12

Depth to PSH _____ feet Well Diameter 2 inches
 Depth to Water 14.91 feet Height of Fluid Column 1.24 feet
 Total Depth 16.15 feet Volume in Well 0.210 gallons

(3 Well Volumes = 0.632 gallons)

GROUNDWATER SAMPLING DATA

Time/date Purged 13:15 5-17-23 Purged Method Bail

Time	Purge Vol (gal)	Cumul Purge Vol (gal)	Temp (°C)	SpC (µs/cm)	pH	ORP (mV)	DO (mg/L)
	—	—					
	—	—					
	—	—					

Actual Purge Volume _____ gals Field Measurements stabilized within ± 10% _____

Time/Date Sampled _____ Purged/Sampled By _____

Sample Method no sample

Requested Analyses _____

Comments/Observations No water coming out on bailer. Bailer will get stuck on bottom of well, NO sample or readings.

Well Casing Volumes

2" diameter = 0.17 gal/ft 4" diameter = 0.66 gal/ft 5" diameter = 1.02 gal/ft 6" diameter = 1.50 gal/ft

MONITOR WELL DEVELOPMENT FIELD FORM

FLUID LEVEL DATA

Well ID MW-4 Date Gauged 5-18-23
 Site Sunset Dairy Time Gauged 10:17
 Depth to PSH _____ feet Well Diameter 2 inches
 Depth to Water 33.25 feet Height of Fluid Column 6.70 feet
 Total Depth 39.95 feet Volume in Well 1.139 gallons
 (3 Well Volumes = 3.41 gallons)

GROUNDWATER SAMPLING DATA

Time/date Purged 10:29 5-18-23 Purged Method Bail

Time	Purge Vol (gal)	Cumul Purge Vol (gal)	Temp (°C)	SpC (µs/cm)	pH	ORP (mV)	DO (mg/L)
10:40	1	1	22.0	7018	7.63	129	1.66
10:46	1	2	22.3	7204	7.40		
11:03	2	4	22.1	7182	7.28		

Actual Purge Volume 7 gals Field Measurements stabilized within ± 10% Y
 Time/Date Sampled 11:35 5-18-23 Purged/Sampled By AN
 Sample Method Bail
 Requested Analyses _____
 Comments/Observations _____

Well Casing Volumes
 2" diameter = 0.17 gal/ft 4" diameter = 0.66 gal/ft 5" diameter = 1.02 gal/ft 6" diameter = 1.50 gal/ft

APPENDIX C

ANALYTICAL LABORATORY REPORTS

(Provided in Electronic Format via CD Located on Front Cover of Report)



Hall Environmental Analysis Laboratory
4901 Hawkins NE
Albuquerque, NM 87109
TEL: 505-345-3975 FAX: 505-345-4107
Website: www.hallenvironmental.com

June 08, 2023

Samantha Carver
Glorieta GeoScience A Divison of GZA
P.O. Box 5727
Santa Fe, NM 87502
TEL: (505) 983-5446
FAX: (505) 983-6482

RE: Organ Dairy

OrderNo.: 2305D40

Dear Samantha Carver:

Hall Environmental Analysis Laboratory received 2 sample(s) on 5/25/2023 for the analyses presented in the following report.

These were analyzed according to EPA procedures or equivalent. To access our accredited tests please go to www.hallenvironmental.com or the state specific web sites. In order to properly interpret your results, it is imperative that you review this report in its entirety. See the sample checklist and/or the Chain of Custody for information regarding the sample receipt temperature and preservation. Data qualifiers or a narrative will be provided if the sample analysis or analytical quality control parameters require a flag. When necessary, data qualifiers are provided on both the sample analysis report and the QC summary report, both sections should be reviewed. All samples are reported, as received, unless otherwise indicated. Lab measurement of analytes considered field parameters that require analysis within 15 minutes of sampling such as pH and residual chlorine are qualified as being analyzed outside of the recommended holding time.

Please don't hesitate to contact HEAL for any additional information or clarifications.

ADHS Cert #AZ0682 -- NMED-DWB Cert #NM9425 -- NMED-Micro Cert #NM0901

Sincerely,

A handwritten signature in black ink, appearing to read "Andy Freeman", is written over a light blue horizontal line.

Andy Freeman
Laboratory Manager
4901 Hawkins NE
Albuquerque, NM 87109

Hall Environmental Analysis Laboratory, Inc.

Analytical Report

Lab Order 2305D40

Date Reported: 6/8/2023

CLIENT: Glorieta GeoScience A Divison of GZA

Client Sample ID: MW 126-13

Project: Organ Dairy

Collection Date: 5/24/2023 9:50:00 AM

Lab ID: 2305D40-001

Matrix: AQUEOUS

Received Date: 5/25/2023 2:25:00 PM

Analyses	Result	RL	Qual	Units	DF	Date Analyzed	Batch
EPA METHOD 300.0: ANIONS							Analyst: SNS
Chloride	710	50	*	mg/L	100	5/26/2023 12:30:19 AM	A97043
Nitrogen, Nitrate (As N)	14	1.0	*	mg/L	10	5/25/2023 11:51:45 PM	A97043
Sulfate	810	50	*	mg/L	100	5/26/2023 12:30:19 AM	A97043
SM2540C MOD: TOTAL DISSOLVED SOLIDS							Analyst: RBC
Total Dissolved Solids	3160	100	*D	mg/L	1	5/30/2023 3:45:00 PM	75205
SM 4500 NORG C: TKN							Analyst: MRA
Nitrogen, Kjeldahl, Total	ND	2.0	D	mg/L	1	6/5/2023 3:25:00 PM	75341

Refer to the QC Summary report and sample login checklist for flagged QC data and preservation information.

Qualifiers:	*	Value exceeds Maximum Contaminant Level.	B	Analyte detected in the associated Method Blank
	D	Sample Diluted Due to Matrix	E	Above Quantitation Range/Estimated Value
	H	Holding times for preparation or analysis exceeded	J	Analyte detected below quantitation limits
	ND	Not Detected at the Reporting Limit	P	Sample pH Not In Range
	PQL	Practical Quantitative Limit	RL	Reporting Limit
	S	% Recovery outside of standard limits. If undiluted results may be estimated.		

Hall Environmental Analysis Laboratory, Inc.

Analytical Report

Lab Order 2305D40

Date Reported: 6/8/2023

CLIENT: Glorieta GeoScience A Divison of GZA

Client Sample ID: MW 126-12

Project: Organ Dairy

Collection Date: 5/24/2023 11:05:00 AM

Lab ID: 2305D40-002

Matrix: AQUEOUS

Received Date: 5/25/2023 2:25:00 PM

Analyses	Result	RL	Qual	Units	DF	Date Analyzed	Batch
EPA METHOD 300.0: ANIONS							Analyst: SNS
Chloride	400	50	*	mg/L	100	5/26/2023 12:56:02 AM	A97043
Nitrogen, Nitrate (As N)	3.2	1.0		mg/L	10	5/26/2023 12:43:11 AM	A97043
Sulfate	490	50	*	mg/L	100	5/26/2023 12:56:02 AM	A97043
SM2540C MOD: TOTAL DISSOLVED SOLIDS							Analyst: RBC
Total Dissolved Solids	2110	100	*D	mg/L	1	5/30/2023 3:45:00 PM	75205
SM 4500 NORG C: TKN							Analyst: MRA
Nitrogen, Kjeldahl, Total	1.4	1.0		mg/L	1	6/5/2023 3:25:00 PM	75341

Refer to the QC Summary report and sample login checklist for flagged QC data and preservation information.

Qualifiers:	*	Value exceeds Maximum Contaminant Level.	B	Analyte detected in the associated Method Blank
	D	Sample Diluted Due to Matrix	E	Above Quantitation Range/Estimated Value
	H	Holding times for preparation or analysis exceeded	J	Analyte detected below quantitation limits
	ND	Not Detected at the Reporting Limit	P	Sample pH Not In Range
	PQL	Practical Quantitative Limit	RL	Reporting Limit
	S	% Recovery outside of standard limits. If undiluted results may be estimated.		

QC SUMMARY REPORT

Hall Environmental Analysis Laboratory, Inc.

WO#: 2305D40

08-Jun-23

Client: Glorieta GeoScience A Divison of GZA
Project: Organ Dairy

Sample ID: **MB** SampType: **MBLK** TestCode: **EPA Method 300.0: Anions**
 Client ID: **PBW** Batch ID: **A97043** RunNo: **97043**
 Prep Date: Analysis Date: **5/25/2023** SeqNo: **3521824** Units: **mg/L**

Analyte	Result	PQL	SPK value	SPK Ref Val	%REC	LowLimit	HighLimit	%RPD	RPDLimit	Qual
Chloride	ND	0.50								
Nitrogen, Nitrate (As N)	ND	0.10								
Sulfate	ND	0.50								

Sample ID: **LCS** SampType: **LCS** TestCode: **EPA Method 300.0: Anions**
 Client ID: **LCSW** Batch ID: **A97043** RunNo: **97043**
 Prep Date: Analysis Date: **5/25/2023** SeqNo: **3521825** Units: **mg/L**

Analyte	Result	PQL	SPK value	SPK Ref Val	%REC	LowLimit	HighLimit	%RPD	RPDLimit	Qual
Chloride	4.7	0.50	5.000	0	93.3	90	110			
Nitrogen, Nitrate (As N)	2.4	0.10	2.500	0	97.6	90	110			
Sulfate	9.6	0.50	10.00	0	96.1	90	110			

Sample ID: **2305D40-001AMS** SampType: **MS** TestCode: **EPA Method 300.0: Anions**
 Client ID: **MW 126-13** Batch ID: **A97043** RunNo: **97043**
 Prep Date: Analysis Date: **5/26/2023** SeqNo: **3521829** Units: **mg/L**

Analyte	Result	PQL	SPK value	SPK Ref Val	%REC	LowLimit	HighLimit	%RPD	RPDLimit	Qual
Nitrogen, Nitrate (As N)	39	1.0	25.00	14.41	98.9	89.8	110			

Sample ID: **2305D40-001AMSD** SampType: **MSD** TestCode: **EPA Method 300.0: Anions**
 Client ID: **MW 126-13** Batch ID: **A97043** RunNo: **97043**
 Prep Date: Analysis Date: **5/26/2023** SeqNo: **3521830** Units: **mg/L**

Analyte	Result	PQL	SPK value	SPK Ref Val	%REC	LowLimit	HighLimit	%RPD	RPDLimit	Qual
Nitrogen, Nitrate (As N)	39	1.0	25.00	14.41	99.7	87.7	111	0.501	20	

Qualifiers:

- * Value exceeds Maximum Contaminant Level.
- D Sample Diluted Due to Matrix
- H Holding times for preparation or analysis exceeded
- ND Not Detected at the Reporting Limit
- PQL Practical Quantitative Limit
- S % Recovery outside of standard limits. If undiluted results may be estimated.
- B Analyte detected in the associated Method Blank
- E Above Quantitation Range/Estimated Value
- J Analyte detected below quantitation limits
- P Sample pH Not In Range
- RL Reporting Limit

QC SUMMARY REPORT

Hall Environmental Analysis Laboratory, Inc.

WO#: 2305D40

08-Jun-23

Client: Glorieta GeoScience A Divison of GZA

Project: Organ Dairy

Sample ID: MB-75205	SampType: MBLK	TestCode: SM2540C MOD: Total Dissolved Solids								
Client ID: PBW	Batch ID: 75205	RunNo: 97090								
Prep Date: 5/26/2023	Analysis Date: 5/30/2023	SeqNo: 3524441	Units: mg/L							
Analyte	Result	PQL	SPK value	SPK Ref Val	%REC	LowLimit	HighLimit	%RPD	RPDLimit	Qual
Total Dissolved Solids	ND	50.0								

Sample ID: LCS-75205	SampType: LCS	TestCode: SM2540C MOD: Total Dissolved Solids								
Client ID: LCSW	Batch ID: 75205	RunNo: 97090								
Prep Date: 5/26/2023	Analysis Date: 5/30/2023	SeqNo: 3524442	Units: mg/L							
Analyte	Result	PQL	SPK value	SPK Ref Val	%REC	LowLimit	HighLimit	%RPD	RPDLimit	Qual
Total Dissolved Solids	1000	50.0	1000	0	100	80	120			

Qualifiers:

- * Value exceeds Maximum Contaminant Level.
- D Sample Diluted Due to Matrix
- H Holding times for preparation or analysis exceeded
- ND Not Detected at the Reporting Limit
- PQL Practical Quantitative Limit
- S % Recovery outside of standard limits. If undiluted results may be estimated.
- B Analyte detected in the associated Method Blank
- E Above Quantitation Range/Estimated Value
- J Analyte detected below quantitation limits
- P Sample pH Not In Range
- RL Reporting Limit

QC SUMMARY REPORT

Hall Environmental Analysis Laboratory, Inc.

WO#: 2305D40

08-Jun-23

Client: Glorieta GeoScience A Divison of GZA

Project: Organ Dairy

Sample ID: MB-75341	SampType: MBLK	TestCode: SM 4500 Norg C: TKN								
Client ID: PBW	Batch ID: 75341	RunNo: 97242								
Prep Date: 6/5/2023	Analysis Date: 6/5/2023	SeqNo: 3531680	Units: mg/L							
Analyte	Result	PQL	SPK value	SPK Ref Val	%REC	LowLimit	HighLimit	%RPD	RPDLimit	Qual
Nitrogen, Kjeldahl, Total	ND	1.0								

Sample ID: LCS-75341	SampType: LCS	TestCode: SM 4500 Norg C: TKN								
Client ID: LCSW	Batch ID: 75341	RunNo: 97242								
Prep Date: 6/5/2023	Analysis Date: 6/5/2023	SeqNo: 3531681	Units: mg/L							
Analyte	Result	PQL	SPK value	SPK Ref Val	%REC	LowLimit	HighLimit	%RPD	RPDLimit	Qual
Nitrogen, Kjeldahl, Total	10	1.0	10.00	0	101	80	120			

Qualifiers:

- * Value exceeds Maximum Contaminant Level.
- D Sample Diluted Due to Matrix
- H Holding times for preparation or analysis exceeded
- ND Not Detected at the Reporting Limit
- PQL Practical Quantitative Limit
- S % Recovery outside of standard limits. If undiluted results may be estimated.
- B Analyte detected in the associated Method Blank
- E Above Quantitation Range/Estimated Value
- J Analyte detected below quantitation limits
- P Sample pH Not In Range
- RL Reporting Limit

Client Name: **Glorieta GeoScience** Work Order Number: **2305D40** RcptNo: **1**

Received By: **Tracy Casarrubias** 5/25/2023 2:25:00 PM

Completed By: **Desiree Dominguez** 5/25/2023 3:15:46 PM

Reviewed By: *wa 5/25/23*

DZ

Chain of Custody

1. Is Chain of Custody complete? Yes No Not Present
2. How was the sample delivered? Client

Log In

3. Was an attempt made to cool the samples? Yes No NA
4. Were all samples received at a temperature of >0° C to 6.0°C Yes No NA
5. Sample(s) in proper container(s)? Yes No
6. Sufficient sample volume for indicated test(s)? Yes No
7. Are samples (except VOA and ONG) properly preserved? Yes No
8. Was preservative added to bottles? Yes No NA
9. Received at least 1 vial with headspace <1/4" for AQ VOA? Yes No NA
10. Were any sample containers received broken? Yes No
11. Does paperwork match bottle labels?
 (Note discrepancies on chain of custody) Yes No
12. Are matrices correctly identified on Chain of Custody? Yes No
13. Is it clear what analyses were requested? Yes No
14. Were all holding times able to be met?
 (If no, notify customer for authorization.) Yes No

of preserved bottles checked for pH: 2
 (2 or >12 unless noted)
 Adjusted? NO
 Checked by: TMC 5/25/23
<2 Lot #530 534

Special Handling (if applicable)

15. Was client notified of all discrepancies with this order? Yes No NA

Person Notified:	<input type="text"/>	Date:	<input type="text"/>
By Whom:	<input type="text"/>	Via:	<input type="checkbox"/> eMail <input type="checkbox"/> Phone <input type="checkbox"/> Fax <input type="checkbox"/> In Person
Regarding:	<input type="text"/>		
Client Instructions:	<input type="text"/>		

16. Additional remarks:
 Client e-mail not provided on COC. -DAD 5/25/23

17. Cooler Information

Cooler No	Temp °C	Condition	Seal Intact	Seal No	Seal Date	Signed By
1	0.9	Good	Not Present	Yogi		



Hall Environmental Analysis Laboratory
4901 Hawkins NE
Albuquerque, NM 87109
TEL: 505-345-3975 FAX: 505-345-4107
Website: www.hallenvironmental.com

May 30, 2023

Regina Mullen
EA Engineering
320 Gold Ave SW Suite 1210
Albuquerque, NM 87102
TEL:
FAX:

RE: Del Oro Dairy

OrderNo.: 2305A43

Dear Regina Mullen:

Hall Environmental Analysis Laboratory received 2 sample(s) on 5/19/2023 for the analyses presented in the following report.

These were analyzed according to EPA procedures or equivalent. To access our accredited tests please go to www.hallenvironmental.com or the state specific web sites. In order to properly interpret your results, it is imperative that you review this report in its entirety. See the sample checklist and/or the Chain of Custody for information regarding the sample receipt temperature and preservation. Data qualifiers or a narrative will be provided if the sample analysis or analytical quality control parameters require a flag. When necessary, data qualifiers are provided on both the sample analysis report and the QC summary report, both sections should be reviewed. All samples are reported, as received, unless otherwise indicated. Lab measurement of analytes considered field parameters that require analysis within 15 minutes of sampling such as pH and residual chlorine are qualified as being analyzed outside of the recommended holding time.

Please don't hesitate to contact HEAL for any additional information or clarifications.

ADHS Cert #AZ0682 -- NMED-DWB Cert #NM9425 -- NMED-Micro Cert #NM0901

Sincerely,

A handwritten signature in black ink, appearing to read 'Andy Freeman', is written in a cursive style.

Andy Freeman
Laboratory Manager
4901 Hawkins NE
Albuquerque, NM 87109

Hall Environmental Analysis Laboratory, Inc.

Analytical Report

Lab Order 2305A43

Date Reported: 5/30/2023

CLIENT: EA Engineering

Client Sample ID: 692-02

Project: Del Oro Dairy

Collection Date: 5/18/2023 1:53:00 PM

Lab ID: 2305A43-001

Matrix: GROUNDWA

Received Date: 5/19/2023 8:50:00 AM

Analyses	Result	RL	Qual	Units	DF	Date Analyzed	Batch
EPA METHOD 300.0: ANIONS							Analyst: NAI
Chloride	440	50	*	mg/L	100	5/19/2023 2:50:31 PM	R96918
Nitrogen, Nitrite (As N)	ND	1.0		mg/L	10	5/19/2023 2:38:10 PM	R96918
Nitrogen, Nitrate (As N)	25	1.0	*	mg/L	10	5/19/2023 2:38:10 PM	R96918
Sulfate	220	5.0		mg/L	10	5/19/2023 2:38:10 PM	R96918
SM2540C MOD: TOTAL DISSOLVED SOLIDS							Analyst: RBC
Total Dissolved Solids	1590	100	*D	mg/L	1	5/24/2023 3:25:00 PM	75117
SM 4500 NORG C: TKN							Analyst: DML
Nitrogen, Kjeldahl, Total	ND	5.0	D	mg/L	1	5/25/2023 2:40:00 PM	75141

Refer to the QC Summary report and sample login checklist for flagged QC data and preservation information.

Qualifiers:	*	Value exceeds Maximum Contaminant Level.	B	Analyte detected in the associated Method Blank
	D	Sample Diluted Due to Matrix	E	Above Quantitation Range/Estimated Value
	H	Holding times for preparation or analysis exceeded	J	Analyte detected below quantitation limits
	ND	Not Detected at the Reporting Limit	P	Sample pH Not In Range
	PQL	Practical Quantitative Limit	RL	Reporting Limit
	S	% Recovery outside of standard limits. If undiluted results may be estimated.		

Hall Environmental Analysis Laboratory, Inc.

Analytical Report

Lab Order 2305A43

Date Reported: 5/30/2023

CLIENT: EA Engineering

Client Sample ID: EW-04

Project: Del Oro Dairy

Collection Date: 5/18/2023 4:00:00 PM

Lab ID: 2305A43-002

Matrix: GROUNDWA

Received Date: 5/19/2023 8:50:00 AM

Analyses	Result	RL	Qual	Units	DF	Date Analyzed	Batch
EPA METHOD 300.0: ANIONS							Analyst: NAI
Chloride	410	50	*	mg/L	100	5/19/2023 3:39:53 PM	R96918
Nitrogen, Nitrite (As N)	ND	1.0		mg/L	10	5/19/2023 3:02:51 PM	R96918
Nitrogen, Nitrate (As N)	28	1.0	*	mg/L	10	5/19/2023 3:02:51 PM	R96918
Sulfate	220	5.0		mg/L	10	5/19/2023 3:02:51 PM	R96918
SM2540C MOD: TOTAL DISSOLVED SOLIDS							Analyst: RBC
Total Dissolved Solids	1510	100	*D	mg/L	1	5/24/2023 3:25:00 PM	75117
SM 4500 NORG C: TKN							Analyst: DML
Nitrogen, Kjeldahl, Total	ND	5.0	D	mg/L	1	5/25/2023 2:40:00 PM	75141

Refer to the QC Summary report and sample login checklist for flagged QC data and preservation information.

Qualifiers:	*	Value exceeds Maximum Contaminant Level.	B	Analyte detected in the associated Method Blank
	D	Sample Diluted Due to Matrix	E	Above Quantitation Range/Estimated Value
	H	Holding times for preparation or analysis exceeded	J	Analyte detected below quantitation limits
	ND	Not Detected at the Reporting Limit	P	Sample pH Not In Range
	PQL	Practical Quantitative Limit	RL	Reporting Limit
	S	% Recovery outside of standard limits. If undiluted results may be estimated.		

QC SUMMARY REPORT

Hall Environmental Analysis Laboratory, Inc.

WO#: 2305A43

30-May-23

Client: EA Engineering

Project: Del Oro Dairy

Sample ID: MB	SampType: mblk	TestCode: EPA Method 300.0: Anions								
Client ID: PBW	Batch ID: R96918	RunNo: 96918								
Prep Date:	Analysis Date: 5/19/2023	SeqNo: 3515989			Units: mg/L					
Analyte	Result	PQL	SPK value	SPK Ref Val	%REC	LowLimit	HighLimit	%RPD	RPDLimit	Qual
Chloride	ND	0.50								
Nitrogen, Nitrite (As N)	ND	0.10								
Nitrogen, Nitrate (As N)	ND	0.10								
Sulfate	ND	0.50								

Sample ID: LCS	SampType: lcs	TestCode: EPA Method 300.0: Anions								
Client ID: LCSW	Batch ID: R96918	RunNo: 96918								
Prep Date:	Analysis Date: 5/19/2023	SeqNo: 3515990			Units: mg/L					
Analyte	Result	PQL	SPK value	SPK Ref Val	%REC	LowLimit	HighLimit	%RPD	RPDLimit	Qual
Chloride	4.8	0.50	5.000	0	96.4	90	110			
Nitrogen, Nitrite (As N)	0.98	0.10	1.000	0	97.5	90	110			
Nitrogen, Nitrate (As N)	2.5	0.10	2.500	0	102	90	110			
Sulfate	9.8	0.50	10.00	0	98.4	90	110			

Sample ID: 2305A43-002AMS	SampType: MS	TestCode: EPA Method 300.0: Anions								
Client ID: EW-04	Batch ID: R96918	RunNo: 96918								
Prep Date:	Analysis Date: 5/19/2023	SeqNo: 3516004			Units: mg/L					
Analyte	Result	PQL	SPK value	SPK Ref Val	%REC	LowLimit	HighLimit	%RPD	RPDLimit	Qual
Nitrogen, Nitrite (As N)	9.0	1.0	10.00	0	90.4	83	110			
Nitrogen, Nitrate (As N)	54	1.0	25.00	28.08	103	89.8	110			
Sulfate	310	5.0	100.0	216.9	97.4	84.9	110			

Sample ID: 2305A43-002AMSD	SampType: MSD	TestCode: EPA Method 300.0: Anions								
Client ID: EW-04	Batch ID: R96918	RunNo: 96918								
Prep Date:	Analysis Date: 5/19/2023	SeqNo: 3516005			Units: mg/L					
Analyte	Result	PQL	SPK value	SPK Ref Val	%REC	LowLimit	HighLimit	%RPD	RPDLimit	Qual
Nitrogen, Nitrite (As N)	8.9	1.0	10.00	0	89.5	81	110	0.990	20	
Nitrogen, Nitrate (As N)	53	1.0	25.00	28.08	100	87.7	111	1.36	20	
Sulfate	310	5.0	100.0	216.9	93.1	84.9	111	1.40	20	

Qualifiers:

- * Value exceeds Maximum Contaminant Level.
- D Sample Diluted Due to Matrix
- H Holding times for preparation or analysis exceeded
- ND Not Detected at the Reporting Limit
- PQL Practical Quantitative Limit
- S % Recovery outside of standard limits. If undiluted results may be estimated.
- B Analyte detected in the associated Method Blank
- E Above Quantitation Range/Estimated Value
- J Analyte detected below quantitation limits
- P Sample pH Not In Range
- RL Reporting Limit

QC SUMMARY REPORT

Hall Environmental Analysis Laboratory, Inc.

WO#: 2305A43

30-May-23

Client: EA Engineering
Project: Del Oro Dairy

Sample ID: MB-75117	SampType: MBLK	TestCode: SM2540C MOD: Total Dissolved Solids								
Client ID: PBW	Batch ID: 75117	RunNo: 96994								
Prep Date: 5/23/2023	Analysis Date: 5/24/2023	SeqNo: 3519220	Units: mg/L							
Analyte	Result	PQL	SPK value	SPK Ref Val	%REC	LowLimit	HighLimit	%RPD	RPDLimit	Qual
Total Dissolved Solids	ND	50.0								

Sample ID: LCS-75117	SampType: LCS	TestCode: SM2540C MOD: Total Dissolved Solids								
Client ID: LCSW	Batch ID: 75117	RunNo: 96994								
Prep Date: 5/23/2023	Analysis Date: 5/24/2023	SeqNo: 3519221	Units: mg/L							
Analyte	Result	PQL	SPK value	SPK Ref Val	%REC	LowLimit	HighLimit	%RPD	RPDLimit	Qual
Total Dissolved Solids	1010	50.0	1000	0	101	80	120			

Sample ID: 2305A43-001ADUP	SampType: DUP	TestCode: SM2540C MOD: Total Dissolved Solids								
Client ID: 692-02	Batch ID: 75117	RunNo: 96994								
Prep Date: 5/23/2023	Analysis Date: 5/24/2023	SeqNo: 3519225	Units: mg/L							
Analyte	Result	PQL	SPK value	SPK Ref Val	%REC	LowLimit	HighLimit	%RPD	RPDLimit	Qual
Total Dissolved Solids	1580	100						1.01	10	*D

Qualifiers:

- | | |
|---|---|
| * Value exceeds Maximum Contaminant Level. | B Analyte detected in the associated Method Blank |
| D Sample Diluted Due to Matrix | E Above Quantitation Range/Estimated Value |
| H Holding times for preparation or analysis exceeded | J Analyte detected below quantitation limits |
| ND Not Detected at the Reporting Limit | P Sample pH Not In Range |
| PQL Practical Quantitative Limit | RL Reporting Limit |
| S % Recovery outside of standard limits. If undiluted results may be estimated. | |

QC SUMMARY REPORT

Hall Environmental Analysis Laboratory, Inc.

WO#: 2305A43

30-May-23

Client: EA Engineering
Project: Del Oro Dairy

Sample ID: MB-75141	SampType: MBLK	TestCode: SM 4500 Norg C: TKN								
Client ID: PBW	Batch ID: 75141	RunNo: 97029								
Prep Date: 5/24/2023	Analysis Date: 5/25/2023	SeqNo: 3520800	Units: mg/L							
Analyte	Result	PQL	SPK value	SPK Ref Val	%REC	LowLimit	HighLimit	%RPD	RPDLimit	Qual
Nitrogen, Kjeldahl, Total	ND	1.0								

Sample ID: LCS-75141	SampType: LCS	TestCode: SM 4500 Norg C: TKN								
Client ID: LCSW	Batch ID: 75141	RunNo: 97029								
Prep Date: 5/24/2023	Analysis Date: 5/25/2023	SeqNo: 3520801	Units: mg/L							
Analyte	Result	PQL	SPK value	SPK Ref Val	%REC	LowLimit	HighLimit	%RPD	RPDLimit	Qual
Nitrogen, Kjeldahl, Total	9.4	1.0	10.00	0	93.8	80	120			

Qualifiers:

- | | |
|---|---|
| * Value exceeds Maximum Contaminant Level. | B Analyte detected in the associated Method Blank |
| D Sample Diluted Due to Matrix | E Above Quantitation Range/Estimated Value |
| H Holding times for preparation or analysis exceeded | J Analyte detected below quantitation limits |
| ND Not Detected at the Reporting Limit | P Sample pH Not In Range |
| PQL Practical Quantitative Limit | RL Reporting Limit |
| S % Recovery outside of standard limits. If undiluted results may be estimated. | |

Client Name: EA Engineering

Work Order Number: 2305A43

RcptNo: 1

Received By: Cheyenne Cason 5/19/2023 8:50:00 AM *CC*

Completed By: Desiree Dominguez 5/19/2023 9:24:55 AM *DD*

Reviewed By: *WD 5/19/23*

Chain of Custody

1. Is Chain of Custody complete? Yes No Not Present
2. How was the sample delivered? FedEx

Log In

3. Was an attempt made to cool the samples? Yes No NA
4. Were all samples received at a temperature of >0° C to 6.0°C Yes No NA
5. Sample(s) in proper container(s)? Yes No
6. Sufficient sample volume for indicated test(s)? Yes No
7. Are samples (except VOA and ONG) properly preserved? Yes No
8. Was preservative added to bottles? Yes No NA
9. Received at least 1 vial with headspace <1/4" for AQ VOA? Yes No NA
10. Were any sample containers received broken? Yes No
11. Does paperwork match bottle labels? Yes No
 (Note discrepancies on chain of custody)
12. Are matrices correctly identified on Chain of Custody? Yes No
13. Is it clear what analyses were requested? Yes No
14. Were all holding times able to be met? Yes No
 (If no, notify customer for authorization.)

of preserved bottles checked for pH: 3
 (2 or >12 unless noted)
 Adjusted? NO
 Checked by: justia/23
 pH Lot # S38534

Special Handling (if applicable)

15. Was client notified of all discrepancies with this order? Yes No NA

Person Notified:	<input type="text"/>	Date:	<input type="text"/>
By Whom:	<input type="text"/>	Via:	<input type="checkbox"/> eMail <input type="checkbox"/> Phone <input type="checkbox"/> Fax <input type="checkbox"/> In Person
Regarding:	<input type="text"/>		
Client Instructions:	<input type="text"/>		

16. Additional remarks:

17. Cooler Information

Cooler No	Temp °C	Condition	Seal Intact	Seal No	Seal Date	Signed By
1	0.6	Good	Not Present	Yogi		



Hall Environmental Analysis Laboratory
4901 Hawkins NE
Albuquerque, NM 87109
TEL: 505-345-3975 FAX: 505-345-4107
Website: www.hallenvironmental.com

May 26, 2023

Regina Mullen
EA Engineering
320 Gold Ave SW Suite 1210
Albuquerque, NM 87102
TEL:
FAX

RE: Sunset Dairy

OrderNo.: 2305A44

Dear Regina Mullen:

Hall Environmental Analysis Laboratory received 2 sample(s) on 5/19/2023 for the analyses presented in the following report.

These were analyzed according to EPA procedures or equivalent. To access our accredited tests please go to www.hallenvironmental.com or the state specific web sites. In order to properly interpret your results, it is imperative that you review this report in its entirety. See the sample checklist and/or the Chain of Custody for information regarding the sample receipt temperature and preservation. Data qualifiers or a narrative will be provided if the sample analysis or analytical quality control parameters require a flag. When necessary, data qualifiers are provided on both the sample analysis report and the QC summary report, both sections should be reviewed. All samples are reported, as received, unless otherwise indicated. Lab measurement of analytes considered field parameters that require analysis within 15 minutes of sampling such as pH and residual chlorine are qualified as being analyzed outside of the recommended holding time.

Please don't hesitate to contact HEAL for any additional information or clarifications.

ADHS Cert #AZ0682 -- NMED-DWB Cert #NM9425 -- NMED-Micro Cert #NM0901

Sincerely,

A handwritten signature in black ink, appearing to read 'Andy Freeman', is written in a cursive style.

Andy Freeman
Laboratory Manager
4901 Hawkins NE
Albuquerque, NM 87109

Hall Environmental Analysis Laboratory, Inc.

Analytical Report

Lab Order 2305A44

Date Reported: 5/26/2023

CLIENT: EA Engineering

Client Sample ID: 257-02

Project: Sunset Dairy

Collection Date: 5/18/2023 9:46:00 AM

Lab ID: 2305A44-001

Matrix: GROUNDWA

Received Date: 5/19/2023 8:50:00 AM

Analyses	Result	RL	Qual	Units	DF	Date Analyzed	Batch
EPA METHOD 300.0: ANIONS							Analyst: NAI
Chloride	710	50	*	mg/L	100	5/19/2023 1:36:27 PM	R96918
Nitrogen, Nitrate (As N)	4.6	1.0		mg/L	10	5/19/2023 1:24:07 PM	R96918
Sulfate	460	50	*	mg/L	100	5/19/2023 1:36:27 PM	R96918
SM2540C MOD: TOTAL DISSOLVED SOLIDS							Analyst: RBC
Total Dissolved Solids	2680	100	*D	mg/L	1	5/24/2023 3:25:00 PM	75117
SM 4500 NORG C: TKN							Analyst: DML
Nitrogen, Kjeldahl, Total	ND	1.0		mg/L	1	5/25/2023 2:20:00 PM	75142

Refer to the QC Summary report and sample login checklist for flagged QC data and preservation information.

Qualifiers:	*	Value exceeds Maximum Contaminant Level.	B	Analyte detected in the associated Method Blank
	D	Sample Diluted Due to Matrix	E	Above Quantitation Range/Estimated Value
	H	Holding times for preparation or analysis exceeded	J	Analyte detected below quantitation limits
	ND	Not Detected at the Reporting Limit	P	Sample pH Not In Range
	PQL	Practical Quantitative Limit	RL	Reporting Limit
	S	% Recovery outside of standard limits. If undiluted results may be estimated.		

Hall Environmental Analysis Laboratory, Inc.

Analytical Report

Lab Order 2305A44

Date Reported: 5/26/2023

CLIENT: EA Engineering

Client Sample ID: MW-4

Project: Sunset Dairy

Collection Date: 5/18/2023 11:35:00 AM

Lab ID: 2305A44-002

Matrix: GROUNDWA

Received Date: 5/19/2023 8:50:00 AM

Analyses	Result	RL	Qual	Units	DF	Date Analyzed	Batch
EPA METHOD 300.0: ANIONS							Analyst: NAI
Chloride	1500	50	*	mg/L	100	5/19/2023 2:25:50 PM	R96918
Nitrogen, Nitrate (As N)	ND	1.0		mg/L	10	5/19/2023 2:13:29 PM	R96918
Sulfate	1100	50	*	mg/L	100	5/19/2023 2:25:50 PM	R96918
SM2540C MOD: TOTAL DISSOLVED SOLIDS							Analyst: RBC
Total Dissolved Solids	4700	250	*D	mg/L	1	5/24/2023 3:25:00 PM	75117
SM 4500 NORG C: TKN							Analyst: DML
Nitrogen, Kjeldahl, Total	ND	1.0		mg/L	1	5/25/2023 2:20:00 PM	75142

Refer to the QC Summary report and sample login checklist for flagged QC data and preservation information.

Qualifiers:	*	Value exceeds Maximum Contaminant Level.	B	Analyte detected in the associated Method Blank
	D	Sample Diluted Due to Matrix	E	Above Quantitation Range/Estimated Value
	H	Holding times for preparation or analysis exceeded	J	Analyte detected below quantitation limits
	ND	Not Detected at the Reporting Limit	P	Sample pH Not In Range
	PQL	Practical Quantitative Limit	RL	Reporting Limit
	S	% Recovery outside of standard limits. If undiluted results may be estimated.		

QC SUMMARY REPORT

Hall Environmental Analysis Laboratory, Inc.

WO#: 2305A44

26-May-23

Client: EA Engineering

Project: Sunset Dairy

Sample ID: MB	SampType: mblk	TestCode: EPA Method 300.0: Anions								
Client ID: PBW	Batch ID: R96918	RunNo: 96918								
Prep Date:	Analysis Date: 5/19/2023	SeqNo: 3515989 Units: mg/L								
Analyte	Result	PQL	SPK value	SPK Ref Val	%REC	LowLimit	HighLimit	%RPD	RPDLimit	Qual

Chloride ND 0.50

Nitrogen, Nitrate (As N) ND 0.10

Sulfate ND 0.50

Sample ID: LCS	SampType: ics	TestCode: EPA Method 300.0: Anions								
Client ID: LCSW	Batch ID: R96918	RunNo: 96918								
Prep Date:	Analysis Date: 5/19/2023	SeqNo: 3515990 Units: mg/L								
Analyte	Result	PQL	SPK value	SPK Ref Val	%REC	LowLimit	HighLimit	%RPD	RPDLimit	Qual

Chloride 4.8 0.50 5.000 0 96.4 90 110

Nitrogen, Nitrate (As N) 2.5 0.10 2.500 0 102 90 110

Sulfate 9.8 0.50 10.00 0 98.4 90 110

Qualifiers:

* Value exceeds Maximum Contaminant Level.

D Sample Diluted Due to Matrix

H Holding times for preparation or analysis exceeded

ND Not Detected at the Reporting Limit

PQL Practical Quantitative Limit

S % Recovery outside of standard limits. If undiluted results may be estimated.

B Analyte detected in the associated Method Blank

E Above Quantitation Range/Estimated Value

J Analyte detected below quantitation limits

P Sample pH Not In Range

RL Reporting Limit

QC SUMMARY REPORT

Hall Environmental Analysis Laboratory, Inc.

WO#: 2305A44

26-May-23

Client: EA Engineering

Project: Sunset Dairy

Sample ID: MB-75117	SampType: MBLK	TestCode: SM2540C MOD: Total Dissolved Solids								
Client ID: PBW	Batch ID: 75117	RunNo: 96994								
Prep Date: 5/23/2023	Analysis Date: 5/24/2023	SeqNo: 3519220	Units: mg/L							
Analyte	Result	PQL	SPK value	SPK Ref Val	%REC	LowLimit	HighLimit	%RPD	RPDLimit	Qual
Total Dissolved Solids	ND	50.0								

Sample ID: LCS-75117	SampType: LCS	TestCode: SM2540C MOD: Total Dissolved Solids								
Client ID: LCSW	Batch ID: 75117	RunNo: 96994								
Prep Date: 5/23/2023	Analysis Date: 5/24/2023	SeqNo: 3519221	Units: mg/L							
Analyte	Result	PQL	SPK value	SPK Ref Val	%REC	LowLimit	HighLimit	%RPD	RPDLimit	Qual
Total Dissolved Solids	1010	50.0	1000	0	101	80	120			

Qualifiers:

- | | |
|---|---|
| * Value exceeds Maximum Contaminant Level. | B Analyte detected in the associated Method Blank |
| D Sample Diluted Due to Matrix | E Above Quantitation Range/Estimated Value |
| H Holding times for preparation or analysis exceeded | J Analyte detected below quantitation limits |
| ND Not Detected at the Reporting Limit | P Sample pH Not In Range |
| PQL Practical Quantitative Limit | RL Reporting Limit |
| S % Recovery outside of standard limits. If undiluted results may be estimated. | |

QC SUMMARY REPORT

Hall Environmental Analysis Laboratory, Inc.

WO#: 2305A44

26-May-23

Client: EA Engineering
Project: Sunset Dairy

Sample ID: MB-75142	SampType: MBLK	TestCode: SM 4500 Norg C: TKN								
Client ID: PBW	Batch ID: 75142	RunNo: 97028								
Prep Date: 5/24/2023	Analysis Date: 5/25/2023	SeqNo: 3520782	Units: mg/L							
Analyte	Result	PQL	SPK value	SPK Ref Val	%REC	LowLimit	HighLimit	%RPD	RPDLimit	Qual
Nitrogen, Kjeldahl, Total	ND	1.0								

Sample ID: LCS-75142	SampType: LCS	TestCode: SM 4500 Norg C: TKN								
Client ID: LCSW	Batch ID: 75142	RunNo: 97028								
Prep Date: 5/24/2023	Analysis Date: 5/25/2023	SeqNo: 3520783	Units: mg/L							
Analyte	Result	PQL	SPK value	SPK Ref Val	%REC	LowLimit	HighLimit	%RPD	RPDLimit	Qual
Nitrogen, Kjeldahl, Total	10	1.0	10.00	0	101	80	120			

Qualifiers:

- * Value exceeds Maximum Contaminant Level.
- D Sample Diluted Due to Matrix
- H Holding times for preparation or analysis exceeded
- ND Not Detected at the Reporting Limit
- PQL Practical Quantitative Limit
- S % Recovery outside of standard limits. If undiluted results may be estimated.
- B Analyte detected in the associated Method Blank
- E Above Quantitation Range/Estimated Value
- J Analyte detected below quantitation limits
- P Sample pH Not In Range
- RL Reporting Limit

Sample Log-In Check List

Client Name: EA Engineering

Work Order Number: 2305A44

RcptNo: 1

Received By: Cheyenne Cason 5/19/2023 8:50:00 AM *CC*

Completed By: Desiree Dominguez 5/19/2023 9:28:18 AM *DD*

Reviewed By: *WB* 5/19/23

Chain of Custody

1. Is Chain of Custody complete? Yes No Not Present
2. How was the sample delivered? FedEx

Log In

3. Was an attempt made to cool the samples? Yes No NA
4. Were all samples received at a temperature of >0° C to 6.0°C Yes No NA
5. Sample(s) in proper container(s)? Yes No
6. Sufficient sample volume for indicated test(s)? Yes No
7. Are samples (except VOA and ONG) properly preserved? Yes No
8. Was preservative added to bottles? Yes No NA
9. Received at least 1 vial with headspace <1/4" for AQ VOA? Yes No NA
10. Were any sample containers received broken? Yes No
11. Does paperwork match bottle labels? Yes No
 (Note discrepancies on chain of custody)
12. Are matrices correctly identified on Chain of Custody? Yes No
13. Is it clear what analyses were requested? Yes No
14. Were all holding times able to be met? Yes No
 (If no, notify customer for authorization.)

of preserved bottles checked for pH: 2
 (<2 or >12 unless noted)
 Adjusted? NO
 Checked by: justia/23

*ph lot # 5358524 535524
 justia/23.*

Special Handling (if applicable)

15. Was client notified of all discrepancies with this order? Yes No NA

Person Notified:	_____	Date:	_____
By Whom:	_____	Via:	<input type="checkbox"/> eMail <input type="checkbox"/> Phone <input type="checkbox"/> Fax <input type="checkbox"/> In Person
Regarding:	_____		
Client Instructions:	_____		

16. Additional remarks:

17. **Cooler Information**

Cooler No	Temp °C	Condition	Seal Intact	Seal No	Seal Date	Signed By
1	0.6	Good	Not Present	Yogi		



Hall Environmental Analysis Laboratory
4901 Hawkins NE
Albuquerque, NM 87109
TEL: 505-345-3975 FAX: 505-345-4107
Website: www.hallenvironmental.com

June 06, 2023

Regina Mullen
EA Engineering
320 Gold Ave SW Suite 1210
Albuquerque, NM 87102
TEL:
FAX:

RE: Del Oro Dairy

OrderNo.: 2305B00

Dear Regina Mullen:

Hall Environmental Analysis Laboratory received 3 sample(s) on 5/20/2023 for the analyses presented in the following report.

These were analyzed according to EPA procedures or equivalent. To access our accredited tests please go to www.hallenvironmental.com or the state specific web sites. In order to properly interpret your results, it is imperative that you review this report in its entirety. See the sample checklist and/or the Chain of Custody for information regarding the sample receipt temperature and preservation. Data qualifiers or a narrative will be provided if the sample analysis or analytical quality control parameters require a flag. When necessary, data qualifiers are provided on both the sample analysis report and the QC summary report, both sections should be reviewed. All samples are reported, as received, unless otherwise indicated. Lab measurement of analytes considered field parameters that require analysis within 15 minutes of sampling such as pH and residual chlorine are qualified as being analyzed outside of the recommended holding time.

Please don't hesitate to contact HEAL for any additional information or clarifications.

ADHS Cert #AZ0682 -- NMED-DWB Cert #NM9425 -- NMED-Micro Cert #NM0901

Sincerely,

A handwritten signature in black ink, appearing to read "Andy Freeman", is written in a cursive style.

Andy Freeman
Laboratory Manager
4901 Hawkins NE
Albuquerque, NM 87109

Hall Environmental Analysis Laboratory, Inc.

Analytical Report

Lab Order 2305B00

Date Reported: 6/6/2023

CLIENT: EA Engineering

Client Sample ID: EW-02

Project: Del Oro Dairy

Collection Date: 5/19/2023 12:00:00 PM

Lab ID: 2305B00-001

Matrix: AQUEOUS

Received Date: 5/20/2023 12:30:00 PM

Analyses	Result	RL	Qual	Units	DF	Date Analyzed	Batch
EPA METHOD 300.0: ANIONS							Analyst: CAS
Chloride	870	50	*	mg/L	100	5/22/2023 12:39:09 PM	R96941
Sulfate	510	50	*	mg/L	100	5/22/2023 12:39:09 PM	R96941
Nitrate+Nitrite as N	130	10	*	mg/L	50	5/26/2023 2:37:06 PM	R97070
SM2540C MOD: TOTAL DISSOLVED SOLIDS							Analyst: RBC
Total Dissolved Solids	3280	100	*D	mg/L	1	5/24/2023 3:25:00 PM	75117
SM 4500 NORG C: TKN							Analyst: DML
Nitrogen, Kjeldahl, Total	ND	1.0		mg/L	1	5/25/2023 2:40:00 PM	75141

Refer to the QC Summary report and sample login checklist for flagged QC data and preservation information.

Qualifiers:	*	Value exceeds Maximum Contaminant Level.	B	Analyte detected in the associated Method Blank
	D	Sample Diluted Due to Matrix	E	Above Quantitation Range/Estimated Value
	H	Holding times for preparation or analysis exceeded	J	Analyte detected below quantitation limits
	ND	Not Detected at the Reporting Limit	P	Sample pH Not In Range
	PQL	Practical Quantitative Limit	RL	Reporting Limit
	S	% Recovery outside of standard limits. If undiluted results may be estimated.		

Hall Environmental Analysis Laboratory, Inc.

Analytical Report

Lab Order 2305B00

Date Reported: 6/6/2023

CLIENT: EA Engineering

Client Sample ID: EW-05

Project: Del Oro Dairy

Collection Date: 5/19/2023 1:13:00 PM

Lab ID: 2305B00-002

Matrix: AQUEOUS

Received Date: 5/20/2023 12:30:00 PM

Analyses	Result	RL	Qual	Units	DF	Date Analyzed	Batch
EPA METHOD 300.0: ANIONS							Analyst: CAS
Chloride	490	50	*	mg/L	100	5/22/2023 1:03:51 PM	R96941
Sulfate	270	5.0	*	mg/L	10	5/22/2023 12:51:29 PM	R96941
Nitrate+Nitrite as N	17	1.0	*	mg/L	5	5/22/2023 9:17:39 PM	R96941
SM2540C MOD: TOTAL DISSOLVED SOLIDS							Analyst: RBC
Total Dissolved Solids	1820	100	*D	mg/L	1	5/24/2023 3:25:00 PM	75117
SM 4500 NORG C: TKN							Analyst: DML
Nitrogen, Kjeldahl, Total	ND	2.0	D	mg/L	1	5/25/2023 2:40:00 PM	75141

Refer to the QC Summary report and sample login checklist for flagged QC data and preservation information.

Qualifiers:	*	Value exceeds Maximum Contaminant Level.	B	Analyte detected in the associated Method Blank
	D	Sample Diluted Due to Matrix	E	Above Quantitation Range/Estimated Value
	H	Holding times for preparation or analysis exceeded	J	Analyte detected below quantitation limits
	ND	Not Detected at the Reporting Limit	P	Sample pH Not In Range
	PQL	Practical Quantitative Limit	RL	Reporting Limit
	S	% Recovery outside of standard limits. If undiluted results may be estimated.		

Hall Environmental Analysis Laboratory, Inc.

Analytical Report

Lab Order 2305B00

Date Reported: 6/6/2023

CLIENT: EA Engineering

Client Sample ID: EW-01

Project: Del Oro Dairy

Collection Date: 5/19/2023 2:53:00 PM

Lab ID: 2305B00-003

Matrix: AQUEOUS

Received Date: 5/20/2023 12:30:00 PM

Analyses	Result	RL	Qual	Units	DF	Date Analyzed	Batch
EPA METHOD 300.0: ANIONS							Analyst: CAS
Chloride	1100	50	*	mg/L	100	5/22/2023 1:53:13 PM	R96941
Sulfate	670	50	*	mg/L	100	5/22/2023 1:53:13 PM	R96941
Nitrate+Nitrite as N	190	10	*	mg/L	50	5/26/2023 2:49:27 PM	R97070
SM2540C MOD: TOTAL DISSOLVED SOLIDS							Analyst: RBC
Total Dissolved Solids	4220	100	*D	mg/L	1	5/24/2023 3:25:00 PM	75117
SM 4500 NORG C: TKN							Analyst: DML
Nitrogen, Kjeldahl, Total	ND	1.0		mg/L	1	5/25/2023 2:40:00 PM	75141

Refer to the QC Summary report and sample login checklist for flagged QC data and preservation information.

Qualifiers:	*	Value exceeds Maximum Contaminant Level.	B	Analyte detected in the associated Method Blank
	D	Sample Diluted Due to Matrix	E	Above Quantitation Range/Estimated Value
	H	Holding times for preparation or analysis exceeded	J	Analyte detected below quantitation limits
	ND	Not Detected at the Reporting Limit	P	Sample pH Not In Range
	PQL	Practical Quantitative Limit	RL	Reporting Limit
	S	% Recovery outside of standard limits. If undiluted results may be estimated.		

QC SUMMARY REPORT

Hall Environmental Analysis Laboratory, Inc.

WO#: 2305B00

06-Jun-23

Client: EA Engineering
Project: Del Oro Dairy

Sample ID: MB	SampType: mblk	TestCode: EPA Method 300.0: Anions								
Client ID: PBW	Batch ID: R96941	RunNo: 96941								
Prep Date:	Analysis Date: 5/22/2023	SeqNo: 3517016	Units: mg/L							
Analyte	Result	PQL	SPK value	SPK Ref Val	%REC	LowLimit	HighLimit	%RPD	RPDLimit	Qual
Chloride	ND	0.50								
Sulfate	ND	0.50								
Nitrate+Nitrite as N	ND	0.20								

Sample ID: LCS	SampType: ics	TestCode: EPA Method 300.0: Anions								
Client ID: LCSW	Batch ID: R96941	RunNo: 96941								
Prep Date:	Analysis Date: 5/22/2023	SeqNo: 3517017	Units: mg/L							
Analyte	Result	PQL	SPK value	SPK Ref Val	%REC	LowLimit	HighLimit	%RPD	RPDLimit	Qual
Chloride	4.7	0.50	5.000	0	94.1	90	110			
Sulfate	9.6	0.50	10.00	0	96.3	90	110			
Nitrate+Nitrite as N	3.4	0.20	3.500	0	98.0	90	110			

Sample ID: MB	SampType: mblk	TestCode: EPA Method 300.0: Anions								
Client ID: PBW	Batch ID: R97070	RunNo: 97070								
Prep Date:	Analysis Date: 5/26/2023	SeqNo: 3523008	Units: mg/L							
Analyte	Result	PQL	SPK value	SPK Ref Val	%REC	LowLimit	HighLimit	%RPD	RPDLimit	Qual
Nitrate+Nitrite as N	ND	0.20								

Sample ID: LCS	SampType: ics	TestCode: EPA Method 300.0: Anions								
Client ID: LCSW	Batch ID: R97070	RunNo: 97070								
Prep Date:	Analysis Date: 5/26/2023	SeqNo: 3523009	Units: mg/L							
Analyte	Result	PQL	SPK value	SPK Ref Val	%REC	LowLimit	HighLimit	%RPD	RPDLimit	Qual
Nitrate+Nitrite as N	3.4	0.20	3.500	0	96.3	90	110			

Qualifiers:

- | | |
|---|---|
| * Value exceeds Maximum Contaminant Level. | B Analyte detected in the associated Method Blank |
| D Sample Diluted Due to Matrix | E Above Quantitation Range/Estimated Value |
| H Holding times for preparation or analysis exceeded | J Analyte detected below quantitation limits |
| ND Not Detected at the Reporting Limit | P Sample pH Not In Range |
| PQL Practical Quantitative Limit | RL Reporting Limit |
| S % Recovery outside of standard limits. If undiluted results may be estimated. | |

QC SUMMARY REPORT

Hall Environmental Analysis Laboratory, Inc.

WO#: 2305B00

06-Jun-23

Client: EA Engineering
Project: Del Oro Dairy

Sample ID: MB-75117	SampType: MBLK	TestCode: SM2540C MOD: Total Dissolved Solids								
Client ID: PBW	Batch ID: 75117	RunNo: 96994								
Prep Date: 5/23/2023	Analysis Date: 5/24/2023	SeqNo: 3519220	Units: mg/L							
Analyte	Result	PQL	SPK value	SPK Ref Val	%REC	LowLimit	HighLimit	%RPD	RPDLimit	Qual
Total Dissolved Solids	ND	50.0								

Sample ID: LCS-75117	SampType: LCS	TestCode: SM2540C MOD: Total Dissolved Solids								
Client ID: LCSW	Batch ID: 75117	RunNo: 96994								
Prep Date: 5/23/2023	Analysis Date: 5/24/2023	SeqNo: 3519221	Units: mg/L							
Analyte	Result	PQL	SPK value	SPK Ref Val	%REC	LowLimit	HighLimit	%RPD	RPDLimit	Qual
Total Dissolved Solids	1010	50.0	1000	0	101	80	120			

Qualifiers:

- | | |
|---|---|
| * Value exceeds Maximum Contaminant Level. | B Analyte detected in the associated Method Blank |
| D Sample Diluted Due to Matrix | E Above Quantitation Range/Estimated Value |
| H Holding times for preparation or analysis exceeded | J Analyte detected below quantitation limits |
| ND Not Detected at the Reporting Limit | P Sample pH Not In Range |
| PQL Practical Quantitative Limit | RL Reporting Limit |
| S % Recovery outside of standard limits. If undiluted results may be estimated. | |

QC SUMMARY REPORT

Hall Environmental Analysis Laboratory, Inc.

WO#: 2305B00

06-Jun-23

Client: EA Engineering
Project: Del Oro Dairy

Sample ID: MB-75141	SampType: MBLK	TestCode: SM 4500 Norg C: TKN								
Client ID: PBW	Batch ID: 75141	RunNo: 97029								
Prep Date: 5/24/2023	Analysis Date: 5/25/2023	SeqNo: 3520800	Units: mg/L							
Analyte	Result	PQL	SPK value	SPK Ref Val	%REC	LowLimit	HighLimit	%RPD	RPDLimit	Qual
Nitrogen, Kjeldahl, Total	ND	1.0								

Sample ID: LCS-75141	SampType: LCS	TestCode: SM 4500 Norg C: TKN								
Client ID: LCSW	Batch ID: 75141	RunNo: 97029								
Prep Date: 5/24/2023	Analysis Date: 5/25/2023	SeqNo: 3520801	Units: mg/L							
Analyte	Result	PQL	SPK value	SPK Ref Val	%REC	LowLimit	HighLimit	%RPD	RPDLimit	Qual
Nitrogen, Kjeldahl, Total	9.4	1.0	10.00	0	93.8	80	120			

Qualifiers:

- | | |
|---|---|
| * Value exceeds Maximum Contaminant Level. | B Analyte detected in the associated Method Blank |
| D Sample Diluted Due to Matrix | E Above Quantitation Range/Estimated Value |
| H Holding times for preparation or analysis exceeded | J Analyte detected below quantitation limits |
| ND Not Detected at the Reporting Limit | P Sample pH Not In Range |
| PQL Practical Quantitative Limit | RL Reporting Limit |
| S % Recovery outside of standard limits. If undiluted results may be estimated. | |

Sample Log-In Check List

Client Name: EA Engineering

Work Order Number: 2305B00

RcptNo: 1

Received By: Tracy Casarrubias 5/20/2023 12:30:00 PM

Completed By: Tracy Casarrubias 5/20/2023 1:07:04 PM

Reviewed By: *mc 5/22/23*

Chain of Custody

1. Is Chain of Custody complete? Yes No Not Present
2. How was the sample delivered? FedEx

Log In

3. Was an attempt made to cool the samples? Yes No NA
4. Were all samples received at a temperature of >0° C to 6.0°C Yes No NA
5. Sample(s) in proper container(s)? Yes No
6. Sufficient sample volume for indicated test(s)? Yes No
7. Are samples (except VOA and ONG) properly preserved? Yes No
8. Was preservative added to bottles? Yes No NA
9. Received at least 1 vial with headspace <1/4" for AQ VOA? Yes No NA
10. Were any sample containers received broken? Yes No
11. Does paperwork match bottle labels? Yes No
 (Note discrepancies on chain of custody)
12. Are matrices correctly identified on Chain of Custody? Yes No
13. Is it clear what analyses were requested? Yes No
14. Were all holding times able to be met? Yes No
 (If no, notify customer for authorization.)

of preserved bottles checked for pH: *3*

(2) or >12 unless noted
 Adjusted? *No*

Checked by: *mc 5/22/23*

pHs trip lot #538534

Special Handling (if applicable)

15. Was client notified of all discrepancies with this order? Yes No NA

Person Notified: _____ Date: _____
 By Whom: _____ Via: eMail Phone Fax In Person
 Regarding: _____
 Client Instructions: _____

16. Additional remarks:

17. Cooler Information

Cooler No	Temp °C	Condition	Seal Intact	Seal No	Seal Date	Signed By
1	3.5	Good	Not Present	Yogi		



Hall Environmental Analysis Laboratory
4901 Hawkins NE
Albuquerque, NM 87109
TEL: 505-345-3975 FAX: 505-345-4107
Website: www.hallenvironmental.com

June 06, 2023

Regina Mullen
EA Engineering
320 Gold Ave SW Suite 1210
Albuquerque, NM 87102
TEL:
FAX:

RE: Del Oro Dairy

OrderNo.: 2305C23

Dear Regina Mullen:

Hall Environmental Analysis Laboratory received 3 sample(s) on 5/24/2023 for the analyses presented in the following report.

These were analyzed according to EPA procedures or equivalent. To access our accredited tests please go to www.hallenvironmental.com or the state specific web sites. In order to properly interpret your results, it is imperative that you review this report in its entirety. See the sample checklist and/or the Chain of Custody for information regarding the sample receipt temperature and preservation. Data qualifiers or a narrative will be provided if the sample analysis or analytical quality control parameters require a flag. When necessary, data qualifiers are provided on both the sample analysis report and the QC summary report, both sections should be reviewed. All samples are reported, as received, unless otherwise indicated. Lab measurement of analytes considered field parameters that require analysis within 15 minutes of sampling such as pH and residual chlorine are qualified as being analyzed outside of the recommended holding time.

Please don't hesitate to contact HEAL for any additional information or clarifications.

ADHS Cert #AZ0682 -- NMED-DWB Cert #NM9425 -- NMED-Micro Cert #NM0901

Sincerely,

A handwritten signature in black ink, appearing to read "Andy Freeman", is written in a cursive style.

Andy Freeman
Laboratory Manager
4901 Hawkins NE
Albuquerque, NM 87109

Hall Environmental Analysis Laboratory, Inc.

Analytical Report

Lab Order 2305C23

Date Reported: 6/6/2023

CLIENT: EA Engineering

Client Sample ID: 692-09

Project: Del Oro Dairy

Collection Date: 5/23/2023 11:47:00 AM

Lab ID: 2305C23-001

Matrix: GROUNDWA

Received Date: 5/24/2023 8:45:00 AM

Analyses	Result	RL	Qual	Units	DF	Date Analyzed	Batch
EPA METHOD 300.0: ANIONS							Analyst: NAI
Chloride	380	50	*	mg/L	100	5/24/2023 12:55:08 PM	R97015
Nitrogen, Nitrite (As N)	ND	1.0		mg/L	10	5/24/2023 12:16:32 PM	R97015
Nitrogen, Nitrate (As N)	7.0	1.0		mg/L	10	5/24/2023 12:16:32 PM	R97015
Sulfate	210	5.0		mg/L	10	5/24/2023 12:16:32 PM	R97015
SM2540C MOD: TOTAL DISSOLVED SOLIDS							Analyst: RBC
Total Dissolved Solids	1380	50.0	*	mg/L	1	5/30/2023 3:31:00 PM	75204
SM 4500 NORG C: TKN							Analyst: MRA
Nitrogen, Kjeldahl, Total	ND	1.0		mg/L	1	6/2/2023 2:30:00 PM	75292

Refer to the QC Summary report and sample login checklist for flagged QC data and preservation information.

Qualifiers:	*	Value exceeds Maximum Contaminant Level.	B	Analyte detected in the associated Method Blank
	D	Sample Diluted Due to Matrix	E	Above Quantitation Range/Estimated Value
	H	Holding times for preparation or analysis exceeded	J	Analyte detected below quantitation limits
	ND	Not Detected at the Reporting Limit	P	Sample pH Not In Range
	PQL	Practical Quantitative Limit	RL	Reporting Limit
	S	% Recovery outside of standard limits. If undiluted results may be estimated.		

Hall Environmental Analysis Laboratory, Inc.

Analytical Report

Lab Order 2305C23

Date Reported: 6/6/2023

CLIENT: EA Engineering

Client Sample ID: 692-05

Project: Del Oro Dairy

Collection Date: 5/23/2023 1:10:00 PM

Lab ID: 2305C23-002

Matrix: GROUNDWA

Received Date: 5/24/2023 8:45:00 AM

Analyses	Result	RL	Qual	Units	DF	Date Analyzed	Batch
EPA METHOD 300.0: ANIONS							Analyst: NAI
Chloride	400	50	*	mg/L	100	5/24/2023 1:20:51 PM	R97015
Nitrogen, Nitrite (As N)	ND	1.0		mg/L	10	5/24/2023 1:07:59 PM	R97015
Nitrogen, Nitrate (As N)	14	1.0	*	mg/L	10	5/24/2023 1:07:59 PM	R97015
Sulfate	260	5.0	*	mg/L	10	5/24/2023 1:07:59 PM	R97015
SM2540C MOD: TOTAL DISSOLVED SOLIDS							Analyst: RBC
Total Dissolved Solids	1500	100	*D	mg/L	1	5/30/2023 3:31:00 PM	75204
SM 4500 NORG C: TKN							Analyst: MRA
Nitrogen, Kjeldahl, Total	ND	2.0	D	mg/L	1	6/2/2023 2:30:00 PM	75292

Refer to the QC Summary report and sample login checklist for flagged QC data and preservation information.

Qualifiers:	*	Value exceeds Maximum Contaminant Level.	B	Analyte detected in the associated Method Blank
	D	Sample Diluted Due to Matrix	E	Above Quantitation Range/Estimated Value
	H	Holding times for preparation or analysis exceeded	J	Analyte detected below quantitation limits
	ND	Not Detected at the Reporting Limit	P	Sample pH Not In Range
	PQL	Practical Quantitative Limit	RL	Reporting Limit
	S	% Recovery outside of standard limits. If undiluted results may be estimated.		

Hall Environmental Analysis Laboratory, Inc.

Analytical Report

Lab Order 2305C23

Date Reported: 6/6/2023

CLIENT: EA Engineering

Client Sample ID: 692-06

Project: Del Oro Dairy

Collection Date: 5/23/2023 2:36:00 PM

Lab ID: 2305C23-003

Matrix: GROUNDWA

Received Date: 5/24/2023 8:45:00 AM

Analyses	Result	RL	Qual	Units	DF	Date Analyzed	Batch
EPA METHOD 300.0: ANIONS							Analyst: NAI
Chloride	390	50	*	mg/L	100	5/24/2023 2:12:18 PM	R97015
Nitrogen, Nitrite (As N)	ND	1.0		mg/L	10	5/24/2023 1:59:27 PM	R97015
Nitrogen, Nitrate (As N)	4.8	1.0		mg/L	10	5/24/2023 1:59:27 PM	R97015
Sulfate	210	5.0		mg/L	10	5/24/2023 1:59:27 PM	R97015
SM2540C MOD: TOTAL DISSOLVED SOLIDS							Analyst: RBC
Total Dissolved Solids	1410	100	*D	mg/L	1	5/30/2023 3:31:00 PM	75204
SM 4500 NORG C: TKN							Analyst: MRA
Nitrogen, Kjeldahl, Total	ND	1.0		mg/L	1	6/2/2023 2:30:00 PM	75292

Refer to the QC Summary report and sample login checklist for flagged QC data and preservation information.

Qualifiers:	*	Value exceeds Maximum Contaminant Level.	B	Analyte detected in the associated Method Blank
	D	Sample Diluted Due to Matrix	E	Above Quantitation Range/Estimated Value
	H	Holding times for preparation or analysis exceeded	J	Analyte detected below quantitation limits
	ND	Not Detected at the Reporting Limit	P	Sample pH Not In Range
	PQL	Practical Quantitative Limit	RL	Reporting Limit
	S	% Recovery outside of standard limits. If undiluted results may be estimated.		

QC SUMMARY REPORT

Hall Environmental Analysis Laboratory, Inc.

WO#: 2305C23

06-Jun-23

Client: EA Engineering
Project: Del Oro Dairy

Sample ID: MB	SampType: mblk	TestCode: EPA Method 300.0: Anions								
Client ID: PBW	Batch ID: R97015	RunNo: 97015								
Prep Date:	Analysis Date: 5/24/2023	SeqNo: 3520318	Units: mg/L							
Analyte	Result	PQL	SPK value	SPK Ref Val	%REC	LowLimit	HighLimit	%RPD	RPDLimit	Qual
Chloride	ND	0.50								
Nitrogen, Nitrite (As N)	ND	0.10								
Nitrogen, Nitrate (As N)	ND	0.10								
Sulfate	ND	0.50								

Sample ID: LCS	SampType: lcs	TestCode: EPA Method 300.0: Anions								
Client ID: LCSW	Batch ID: R97015	RunNo: 97015								
Prep Date:	Analysis Date: 5/24/2023	SeqNo: 3520319	Units: mg/L							
Analyte	Result	PQL	SPK value	SPK Ref Val	%REC	LowLimit	HighLimit	%RPD	RPDLimit	Qual
Chloride	4.6	0.50	5.000	0	92.7	90	110			
Nitrogen, Nitrite (As N)	0.95	0.10	1.000	0	94.6	90	110			
Nitrogen, Nitrate (As N)	2.5	0.10	2.500	0	99.2	90	110			
Sulfate	9.5	0.50	10.00	0	95.0	90	110			

Sample ID: 2305C23-001AMS	SampType: ms	TestCode: EPA Method 300.0: Anions								
Client ID: 692-09	Batch ID: R97015	RunNo: 97015								
Prep Date:	Analysis Date: 5/24/2023	SeqNo: 3520321	Units: mg/L							
Analyte	Result	PQL	SPK value	SPK Ref Val	%REC	LowLimit	HighLimit	%RPD	RPDLimit	Qual
Nitrogen, Nitrite (As N)	9.5	1.0	10.00	0	95.4	83	110			
Nitrogen, Nitrate (As N)	32	1.0	25.00	6.962	102	89.8	110			
Sulfate	310	5.0	100.0	206.8	101	84.9	110			

Sample ID: 2305C23-001AMSD	SampType: msd	TestCode: EPA Method 300.0: Anions								
Client ID: 692-09	Batch ID: R97015	RunNo: 97015								
Prep Date:	Analysis Date: 5/24/2023	SeqNo: 3520322	Units: mg/L							
Analyte	Result	PQL	SPK value	SPK Ref Val	%REC	LowLimit	HighLimit	%RPD	RPDLimit	Qual
Nitrogen, Nitrite (As N)	9.4	1.0	10.00	0	94.5	81	110	0.958	20	
Nitrogen, Nitrate (As N)	32	1.0	25.00	6.962	100	87.7	111	1.30	20	
Sulfate	300	5.0	100.0	206.8	97.5	84.9	111	1.03	20	

Qualifiers:

- * Value exceeds Maximum Contaminant Level.
- D Sample Diluted Due to Matrix
- H Holding times for preparation or analysis exceeded
- ND Not Detected at the Reporting Limit
- PQL Practical Quantitative Limit
- S % Recovery outside of standard limits. If undiluted results may be estimated.
- B Analyte detected in the associated Method Blank
- E Above Quantitation Range/Estimated Value
- J Analyte detected below quantitation limits
- P Sample pH Not In Range
- RL Reporting Limit

QC SUMMARY REPORT

Hall Environmental Analysis Laboratory, Inc.

WO#: 2305C23

06-Jun-23

Client: EA Engineering
Project: Del Oro Dairy

Sample ID: MB-75204	SampType: MBLK	TestCode: SM2540C MOD: Total Dissolved Solids								
Client ID: PBW	Batch ID: 75204	RunNo: 97089								
Prep Date: 5/26/2023	Analysis Date: 5/30/2023	SeqNo: 3524415	Units: mg/L							
Analyte	Result	PQL	SPK value	SPK Ref Val	%REC	LowLimit	HighLimit	%RPD	RPDLimit	Qual
Total Dissolved Solids	ND	50.0								

Sample ID: LCS-75204	SampType: LCS	TestCode: SM2540C MOD: Total Dissolved Solids								
Client ID: LCSW	Batch ID: 75204	RunNo: 97089								
Prep Date: 5/26/2023	Analysis Date: 5/30/2023	SeqNo: 3524416	Units: mg/L							
Analyte	Result	PQL	SPK value	SPK Ref Val	%REC	LowLimit	HighLimit	%RPD	RPDLimit	Qual
Total Dissolved Solids	983	50.0	1000	0	98.3	80	120			

Qualifiers:

- * Value exceeds Maximum Contaminant Level.
- D Sample Diluted Due to Matrix
- H Holding times for preparation or analysis exceeded
- ND Not Detected at the Reporting Limit
- PQL Practical Quantitative Limit
- S % Recovery outside of standard limits. If undiluted results may be estimated.
- B Analyte detected in the associated Method Blank
- E Above Quantitation Range/Estimated Value
- J Analyte detected below quantitation limits
- P Sample pH Not In Range
- RL Reporting Limit

QC SUMMARY REPORT

Hall Environmental Analysis Laboratory, Inc.

WO#: 2305C23

06-Jun-23

Client: EA Engineering
Project: Del Oro Dairy

Sample ID: MB-75292	SampType: MBLK	TestCode: SM 4500 Norg C: TKN								
Client ID: PBW	Batch ID: 75292	RunNo: 97191								
Prep Date: 6/1/2023	Analysis Date: 6/2/2023	SeqNo: 3529736	Units: mg/L							
Analyte	Result	PQL	SPK value	SPK Ref Val	%REC	LowLimit	HighLimit	%RPD	RPDLimit	Qual
Nitrogen, Kjeldahl, Total	ND	1.0								

Sample ID: LCS-75292	SampType: LCS	TestCode: SM 4500 Norg C: TKN								
Client ID: LCSW	Batch ID: 75292	RunNo: 97191								
Prep Date: 6/1/2023	Analysis Date: 6/2/2023	SeqNo: 3529737	Units: mg/L							
Analyte	Result	PQL	SPK value	SPK Ref Val	%REC	LowLimit	HighLimit	%RPD	RPDLimit	Qual
Nitrogen, Kjeldahl, Total	9.9	1.0	10.00	0	99.4	80	120			

Qualifiers:

- * Value exceeds Maximum Contaminant Level.
- D Sample Diluted Due to Matrix
- H Holding times for preparation or analysis exceeded
- ND Not Detected at the Reporting Limit
- PQL Practical Quantitative Limit
- S % Recovery outside of standard limits. If undiluted results may be estimated.
- B Analyte detected in the associated Method Blank
- E Above Quantitation Range/Estimated Value
- J Analyte detected below quantitation limits
- P Sample pH Not In Range
- RL Reporting Limit



Sample Log-In Check List

Client Name: EA Engineering

Work Order Number: 2305C23

RcptNo: 1

Received By: Tracy Casarrubias 5/24/2023 8:45:00 AM

Completed By: Tracy Casarrubias 5/24/2023 9:07:52 AM

Reviewed By: *wa* 5/24/23

Chain of Custody

1. Is Chain of Custody complete? Yes No Not Present

2. How was the sample delivered? FedEx

Log In

3. Was an attempt made to cool the samples? Yes No NA

4. Were all samples received at a temperature of >0° C to 6.0°C Yes No NA

5. Sample(s) in proper container(s)? Yes No

6. Sufficient sample volume for indicated test(s)? Yes No

7. Are samples (except VOA and ONG) properly preserved? Yes No

8. Was preservative added to bottles? Yes No NA

9. Received at least 1 vial with headspace <1/4" for AQ VOA? Yes No NA

10. Were any sample containers received broken? Yes No

11. Does paperwork match bottle labels?
 (Note discrepancies on chain of custody) Yes No

12. Are matrices correctly identified on Chain of Custody? Yes No

13. Is it clear what analyses were requested? Yes No

14. Were all holding times able to be met?
 (If no, notify customer for authorization.) Yes No

of preserved bottles checked for pH: 3
 (<2 or >12 unless noted)
 Adjusted? NO
 Checked by: ju 5/24/23
 pH Lot # 538534

Special Handling (if applicable)

15. Was client notified of all discrepancies with this order? Yes No NA

Person Notified: _____ Date: _____
 By Whom: _____ Via: eMail Phone Fax In Person
 Regarding: _____
 Client Instructions: _____

16. Additional remarks:

17. Cooler Information

Cooler No	Temp °C	Condition	Seal Intact	Seal No	Seal Date	Signed By
1	5.1	Good	Not Present	Morty		



Hall Environmental Analysis Laboratory
4901 Hawkins NE
Albuquerque, NM 87109
TEL: 505-345-3975 FAX: 505-345-4107
Website: www.hallenvironmental.com

June 08, 2023

Gina Mullen

EA Engineering

320 Gold Ave SW Suite 1210

Albuquerque, NM 87102

TEL:

FAX:

RE: Del Oro Dairy

OrderNo.: 2305D01

Dear Gina Mullen:

Hall Environmental Analysis Laboratory received 3 sample(s) on 5/25/2023 for the analyses presented in the following report.

These were analyzed according to EPA procedures or equivalent. To access our accredited tests please go to www.hallenvironmental.com or the state specific web sites. In order to properly interpret your results, it is imperative that you review this report in its entirety. See the sample checklist and/or the Chain of Custody for information regarding the sample receipt temperature and preservation. Data qualifiers or a narrative will be provided if the sample analysis or analytical quality control parameters require a flag. When necessary, data qualifiers are provided on both the sample analysis report and the QC summary report, both sections should be reviewed. All samples are reported, as received, unless otherwise indicated. Lab measurement of analytes considered field parameters that require analysis within 15 minutes of sampling such as pH and residual chlorine are qualified as being analyzed outside of the recommended holding time.

Please don't hesitate to contact HEAL for any additional information or clarifications.

ADHS Cert #AZ0682 -- NMED-DWB Cert #NM9425 -- NMED-Micro Cert #NM0901

Sincerely,

A handwritten signature in black ink, appearing to read 'Andy Freeman', is written in a cursive style.

Andy Freeman

Laboratory Manager

4901 Hawkins NE

Albuquerque, NM 87109

Hall Environmental Analysis Laboratory, Inc.

Analytical Report

Lab Order 2305D01

Date Reported: 6/8/2023

CLIENT: EA Engineering

Client Sample ID: 692-07

Project: Del Oro Dairy

Collection Date: 5/24/2023 10:51:00 AM

Lab ID: 2305D01-001

Matrix: GROUNDWA

Received Date: 5/25/2023 8:45:00 AM

Analyses	Result	RL	Qual	Units	DF	Date Analyzed	Batch
EPA METHOD 300.0: ANIONS							Analyst: SNS
Chloride	510	50	*	mg/L	100	5/25/2023 1:47:11 PM	R97043
Nitrogen, Nitrite (As N)	ND	1.0		mg/L	10	5/25/2023 1:34:18 PM	R97043
Nitrogen, Nitrate (As N)	3.0	1.0		mg/L	10	5/25/2023 1:34:18 PM	R97043
Sulfate	210	5.0		mg/L	10	5/25/2023 1:34:18 PM	R97043
SM2540C MOD: TOTAL DISSOLVED SOLIDS							Analyst: RBC
Total Dissolved Solids	1510	100	*D	mg/L	1	5/30/2023 3:45:00 PM	75205
SM 4500 NORG C: TKN							Analyst: MRA
Nitrogen, Kjeldahl, Total	ND	1.0		mg/L	1	6/5/2023 3:25:00 PM	75341

Refer to the QC Summary report and sample login checklist for flagged QC data and preservation information.

Qualifiers:	*	Value exceeds Maximum Contaminant Level.	B	Analyte detected in the associated Method Blank
	D	Sample Diluted Due to Matrix	E	Above Quantitation Range/Estimated Value
	H	Holding times for preparation or analysis exceeded	J	Analyte detected below quantitation limits
	ND	Not Detected at the Reporting Limit	P	Sample pH Not In Range
	PQL	Practical Quantitative Limit	RL	Reporting Limit
	S	% Recovery outside of standard limits. If undiluted results may be estimated.		

Hall Environmental Analysis Laboratory, Inc.

Analytical Report
 Lab Order 2305D01
 Date Reported: 6/8/2023

CLIENT: EA Engineering

Client Sample ID: 692-10

Project: Del Oro Dairy

Collection Date: 5/24/2023 12:00:00 PM

Lab ID: 2305D01-002

Matrix: GROUNDWA

Received Date: 5/25/2023 8:45:00 AM

Analyses	Result	RL	Qual	Units	DF	Date Analyzed	Batch
EPA METHOD 300.0: ANIONS							Analyst: SNS
Chloride	630	50	*	mg/L	100	5/25/2023 2:12:54 PM	R97043
Nitrogen, Nitrite (As N)	ND	1.0		mg/L	10	5/25/2023 2:00:02 PM	R97043
Nitrogen, Nitrate (As N)	ND	1.0		mg/L	10	5/25/2023 2:00:02 PM	R97043
Sulfate	190	5.0		mg/L	10	5/25/2023 2:00:02 PM	R97043
SM2540C MOD: TOTAL DISSOLVED SOLIDS							Analyst: RBC
Total Dissolved Solids	1520	250	*D	mg/L	1	5/30/2023 3:45:00 PM	75205
SM 4500 NORG C: TKN							Analyst: MRA
Nitrogen, Kjeldahl, Total	ND	2.0	D	mg/L	1	6/5/2023 3:25:00 PM	75341

Refer to the QC Summary report and sample login checklist for flagged QC data and preservation information.

Qualifiers:	*	Value exceeds Maximum Contaminant Level.	B	Analyte detected in the associated Method Blank
	D	Sample Diluted Due to Matrix	E	Above Quantitation Range/Estimated Value
	H	Holding times for preparation or analysis exceeded	J	Analyte detected below quantitation limits
	ND	Not Detected at the Reporting Limit	P	Sample pH Not In Range
	PQL	Practical Quantitative Limit	RL	Reporting Limit
	S	% Recovery outside of standard limits. If undiluted results may be estimated.		

Hall Environmental Analysis Laboratory, Inc.

Analytical Report

Lab Order 2305D01

Date Reported: 6/8/2023

CLIENT: EA Engineering

Client Sample ID: 692-08

Project: Del Oro Dairy

Collection Date: 5/24/2023 3:05:00 PM

Lab ID: 2305D01-003

Matrix: GROUNDWA

Received Date: 5/25/2023 8:45:00 AM

Analyses	Result	RL	Qual	Units	DF	Date Analyzed	Batch
EPA METHOD 300.0: ANIONS							Analyst: SNS
Chloride	360	50	*	mg/L	100	5/25/2023 2:38:38 PM	R97043
Nitrogen, Nitrite (As N)	ND	1.0		mg/L	10	5/25/2023 2:25:46 PM	R97043
Nitrogen, Nitrate (As N)	5.2	1.0		mg/L	10	5/25/2023 2:25:46 PM	R97043
Sulfate	190	5.0		mg/L	10	5/25/2023 2:25:46 PM	R97043
SM2540C MOD: TOTAL DISSOLVED SOLIDS							Analyst: RBC
Total Dissolved Solids	1290	100	*D	mg/L	1	5/30/2023 3:45:00 PM	75205
SM 4500 NORG C: TKN							Analyst: MRA
Nitrogen, Kjeldahl, Total	ND	1.0		mg/L	1	6/5/2023 3:25:00 PM	75341

Refer to the QC Summary report and sample login checklist for flagged QC data and preservation information.

Qualifiers:	*	Value exceeds Maximum Contaminant Level.	B	Analyte detected in the associated Method Blank
	D	Sample Diluted Due to Matrix	E	Above Quantitation Range/Estimated Value
	H	Holding times for preparation or analysis exceeded	J	Analyte detected below quantitation limits
	ND	Not Detected at the Reporting Limit	P	Sample pH Not In Range
	PQL	Practical Quantitative Limit	RL	Reporting Limit
	S	% Recovery outside of standard limits. If undiluted results may be estimated.		

QC SUMMARY REPORT

Hall Environmental Analysis Laboratory, Inc.

WO#: 2305D01

08-Jun-23

Client: EA Engineering
Project: Del Oro Dairy

Sample ID: MB	SampType: MBLK	TestCode: EPA Method 300.0: Anions								
Client ID: PBW	Batch ID: R97043	RunNo: 97043								
Prep Date:	Analysis Date: 5/25/2023	SeqNo: 3521770	Units: mg/L							
Analyte	Result	PQL	SPK value	SPK Ref Val	%REC	LowLimit	HighLimit	%RPD	RPDLimit	Qual
Chloride	ND	0.50								
Nitrogen, Nitrite (As N)	ND	0.10								
Nitrogen, Nitrate (As N)	ND	0.10								
Sulfate	ND	0.50								

Sample ID: LCS	SampType: LCS	TestCode: EPA Method 300.0: Anions								
Client ID: LCSW	Batch ID: R97043	RunNo: 97043								
Prep Date:	Analysis Date: 5/25/2023	SeqNo: 3521771	Units: mg/L							
Analyte	Result	PQL	SPK value	SPK Ref Val	%REC	LowLimit	HighLimit	%RPD	RPDLimit	Qual
Chloride	4.6	0.50	5.000	0	92.2	90	110			
Nitrogen, Nitrite (As N)	0.94	0.10	1.000	0	94.3	90	110			
Nitrogen, Nitrate (As N)	2.4	0.10	2.500	0	96.6	90	110			
Sulfate	9.5	0.50	10.00	0	95.0	90	110			

Qualifiers:

- * Value exceeds Maximum Contaminant Level.
- D Sample Diluted Due to Matrix
- H Holding times for preparation or analysis exceeded
- ND Not Detected at the Reporting Limit
- PQL Practical Quantitative Limit
- S % Recovery outside of standard limits. If undiluted results may be estimated.
- B Analyte detected in the associated Method Blank
- E Above Quantitation Range/Estimated Value
- J Analyte detected below quantitation limits
- P Sample pH Not In Range
- RL Reporting Limit

QC SUMMARY REPORT

Hall Environmental Analysis Laboratory, Inc.

WO#: 2305D01

08-Jun-23

Client: EA Engineering
Project: Del Oro Dairy

Sample ID: MB-75205	SampType: MBLK	TestCode: SM2540C MOD: Total Dissolved Solids								
Client ID: PBW	Batch ID: 75205	RunNo: 97090								
Prep Date: 5/26/2023	Analysis Date: 5/30/2023	SeqNo: 3524441	Units: mg/L							
Analyte	Result	PQL	SPK value	SPK Ref Val	%REC	LowLimit	HighLimit	%RPD	RPDLimit	Qual
Total Dissolved Solids	ND	50.0								

Sample ID: LCS-75205	SampType: LCS	TestCode: SM2540C MOD: Total Dissolved Solids								
Client ID: LCSW	Batch ID: 75205	RunNo: 97090								
Prep Date: 5/26/2023	Analysis Date: 5/30/2023	SeqNo: 3524442	Units: mg/L							
Analyte	Result	PQL	SPK value	SPK Ref Val	%REC	LowLimit	HighLimit	%RPD	RPDLimit	Qual
Total Dissolved Solids	1000	50.0	1000	0	100	80	120			

Qualifiers:

- | | |
|---|---|
| * Value exceeds Maximum Contaminant Level. | B Analyte detected in the associated Method Blank |
| D Sample Diluted Due to Matrix | E Above Quantitation Range/Estimated Value |
| H Holding times for preparation or analysis exceeded | J Analyte detected below quantitation limits |
| ND Not Detected at the Reporting Limit | P Sample pH Not In Range |
| PQL Practical Quantitative Limit | RL Reporting Limit |
| S % Recovery outside of standard limits. If undiluted results may be estimated. | |

QC SUMMARY REPORT

Hall Environmental Analysis Laboratory, Inc.

WO#: 2305D01

08-Jun-23

Client: EA Engineering
Project: Del Oro Dairy

Sample ID: MB-75341	SampType: MBLK	TestCode: SM 4500 Norg C: TKN								
Client ID: PBW	Batch ID: 75341	RunNo: 97242								
Prep Date: 6/5/2023	Analysis Date: 6/5/2023	SeqNo: 3531680	Units: mg/L							
Analyte	Result	PQL	SPK value	SPK Ref Val	%REC	LowLimit	HighLimit	%RPD	RPDLimit	Qual
Nitrogen, Kjeldahl, Total	ND	1.0								

Sample ID: LCS-75341	SampType: LCS	TestCode: SM 4500 Norg C: TKN								
Client ID: LCSW	Batch ID: 75341	RunNo: 97242								
Prep Date: 6/5/2023	Analysis Date: 6/5/2023	SeqNo: 3531681	Units: mg/L							
Analyte	Result	PQL	SPK value	SPK Ref Val	%REC	LowLimit	HighLimit	%RPD	RPDLimit	Qual
Nitrogen, Kjeldahl, Total	10	1.0	10.00	0	101	80	120			

Qualifiers:

- | | |
|---|---|
| * Value exceeds Maximum Contaminant Level. | B Analyte detected in the associated Method Blank |
| D Sample Diluted Due to Matrix | E Above Quantitation Range/Estimated Value |
| H Holding times for preparation or analysis exceeded | J Analyte detected below quantitation limits |
| ND Not Detected at the Reporting Limit | P Sample pH Not In Range |
| PQL Practical Quantitative Limit | RL Reporting Limit |
| S % Recovery outside of standard limits. If undiluted results may be estimated. | |

Client Name: EA Engineering

Work Order Number: 2305D01

RcptNo: 1

Received By: Desiree Dominguez 5/25/2023 8:45:00 AM

Completed By: Kasandra Jimena Garcia 5/25/2023 10:01:15 AM

Reviewed By: *JH 5-25-23*

DD
KJ

Chain of Custody

1. Is Chain of Custody complete? Yes No Not Present

2. How was the sample delivered? FedEx

Log In

3. Was an attempt made to cool the samples? Yes No NA

4. Were all samples received at a temperature of >0° C to 6.0°C Yes No NA

5. Sample(s) in proper container(s)? Yes No

6. Sufficient sample volume for indicated test(s)? Yes No

7. Are samples (except VOA and ONG) properly preserved? Yes No

8. Was preservative added to bottles? Yes No NA

9. Received at least 1 vial with headspace <1/4" for AQ VOA? Yes No NA

10. Were any sample containers received broken? Yes No

11. Does paperwork match bottle labels? Yes No
 (Note discrepancies on chain of custody)

12. Are matrices correctly identified on Chain of Custody? Yes No

13. Is it clear what analyses were requested? Yes No

14. Were all holding times able to be met? Yes No
 (If no, notify customer for authorization.)

of preserved bottles checked for pH: 3
 (<2 or >12 unless noted)
 Adjusted? No
 Checked by: JMS/25/23

ph lot # 538534

Special Handling (if applicable)

15. Was client notified of all discrepancies with this order? Yes No NA

Person Notified:	<input type="text"/>	Date:	<input type="text"/>
By Whom:	<input type="text"/>	Via:	<input type="checkbox"/> eMail <input type="checkbox"/> Phone <input type="checkbox"/> Fax <input type="checkbox"/> In Person
Regarding:	<input type="text"/>		
Client Instructions:	<input type="text"/>		

16. Additional remarks:

17. Cooler Information

Cooler No	Temp °C	Condition	Seal Intact	Seal No	Seal Date	Signed By
1	0.1	Good	Not Present	MORTY		



Hall Environmental Analysis Laboratory
4901 Hawkins NE
Albuquerque, NM 87109
TEL: 505-345-3975 FAX: 505-345-4107
Website: www.hallenvironmental.com

June 14, 2023

Regina Mullen
EA Engineering
320 Gold Ave SW Suite 1210
Albuquerque, NM 87102
TEL:
FAX

RE: Dona Ana Dairies

OrderNo.: 2305D75

Dear Regina Mullen:

Hall Environmental Analysis Laboratory received 4 sample(s) on 5/26/2023 for the analyses presented in the following report.

These were analyzed according to EPA procedures or equivalent. To access our accredited tests please go to www.hallenvironmental.com or the state specific web sites. In order to properly interpret your results, it is imperative that you review this report in its entirety. See the sample checklist and/or the Chain of Custody for information regarding the sample receipt temperature and preservation. Data qualifiers or a narrative will be provided if the sample analysis or analytical quality control parameters require a flag. When necessary, data qualifiers are provided on both the sample analysis report and the QC summary report, both sections should be reviewed. All samples are reported, as received, unless otherwise indicated. Lab measurement of analytes considered field parameters that require analysis within 15 minutes of sampling such as pH and residual chlorine are qualified as being analyzed outside of the recommended holding time.

Please don't hesitate to contact HEAL for any additional information or clarifications.

ADHS Cert #AZ0682 -- NMED-DWB Cert #NM9425 -- NMED-Micro Cert #NM0901

Sincerely,

A handwritten signature in black ink, appearing to read "Andy Freeman", is written in a cursive style.

Andy Freeman
Laboratory Manager
4901 Hawkins NE
Albuquerque, NM 87109

Hall Environmental Analysis Laboratory, Inc.

Analytical Report

Lab Order 2305D75

Date Reported: 6/14/2023

CLIENT: EA Engineering

Client Sample ID: DAD-01

Project: Dona Ana Dairies

Collection Date: 5/25/2023 10:31:00 AM

Lab ID: 2305D75-001

Matrix: GROUNDWA

Received Date: 5/26/2023 9:45:00 AM

Analyses	Result	RL	Qual	Units	DF	Date Analyzed
EPA METHOD 300.0: ANIONS						Analyst: JMT
Chloride	370	50	*	mg/L	100	5/26/2023 5:29:57 PM
Nitrogen, Nitrite (As N)	ND	1.0		mg/L	10	5/26/2023 5:17:36 PM
Nitrogen, Nitrate (As N)	13	1.0	*	mg/L	10	5/26/2023 5:17:36 PM
SM2540C MOD: TOTAL DISSOLVED SOLIDS						Analyst: KS
Total Dissolved Solids	1460	100	*D	mg/L	1	6/1/2023 5:08:00 PM
SM 4500 NORG C: TKN						Analyst: RBC
Nitrogen, Kjeldahl, Total	ND	2.0	D	mg/L	1	6/9/2023 8:19:00 AM

Refer to the QC Summary report and sample login checklist for flagged QC data and preservation information.

Qualifiers:	*	Value exceeds Maximum Contaminant Level.	B	Analyte detected in the associated Method Blank
	D	Sample Diluted Due to Matrix	E	Above Quantitation Range/Estimated Value
	H	Holding times for preparation or analysis exceeded	J	Analyte detected below quantitation limits
	ND	Not Detected at the Reporting Limit	P	Sample pH Not In Range
	PQL	Practical Quantitative Limit	RL	Reporting Limit
	S	% Recovery outside of standard limits. If undiluted results may be estimated.		

Hall Environmental Analysis Laboratory, Inc.

Analytical Report

Lab Order 2305D75

Date Reported: 6/14/2023

CLIENT: EA Engineering

Client Sample ID: DAD-12

Project: Dona Ana Dairies

Collection Date: 5/25/2023 12:20:00 PM

Lab ID: 2305D75-002

Matrix: GROUNDWA

Received Date: 5/26/2023 9:45:00 AM

Analyses	Result	RL	Qual	Units	DF	Date Analyzed
EPA METHOD 300.0: ANIONS						Analyst: JMT
Chloride	720	50	*	mg/L	100	5/26/2023 5:54:38 PM
Nitrogen, Nitrite (As N)	ND	1.0		mg/L	10	5/26/2023 5:42:16 PM
Nitrogen, Nitrate (As N)	10	1.0	*	mg/L	10	5/26/2023 5:42:16 PM
SM2540C MOD: TOTAL DISSOLVED SOLIDS						Analyst: KS
Total Dissolved Solids	2980	100	*D	mg/L	1	6/1/2023 5:08:00 PM
SM 4500 NORG C: TKN						Analyst: DML
Nitrogen, Kjeldahl, Total	ND	2.0	D	mg/L	1	6/7/2023 2:22:00 PM

Refer to the QC Summary report and sample login checklist for flagged QC data and preservation information.

Qualifiers:	* Value exceeds Maximum Contaminant Level.	B Analyte detected in the associated Method Blank
	D Sample Diluted Due to Matrix	E Above Quantitation Range/Estimated Value
	H Holding times for preparation or analysis exceeded	J Analyte detected below quantitation limits
	ND Not Detected at the Reporting Limit	P Sample pH Not In Range
	PQL Practical Quantitative Limit	RL Reporting Limit
	S % Recovery outside of standard limits. If undiluted results may be estimated.	

Hall Environmental Analysis Laboratory, Inc.

Analytical Report

Lab Order 2305D75

Date Reported: 6/14/2023

CLIENT: EA Engineering

Client Sample ID: DAD-13

Project: Dona Ana Dairies

Collection Date: 5/25/2023 2:02:00 PM

Lab ID: 2305D75-003

Matrix: GROUNDWA

Received Date: 5/26/2023 9:45:00 AM

Analyses	Result	RL	Qual	Units	DF	Date Analyzed
EPA METHOD 300.0: ANIONS						Analyst: JMT
Chloride	570	50	*	mg/L	100	5/26/2023 6:19:19 PM
Nitrogen, Nitrite (As N)	ND	1.0		mg/L	10	5/26/2023 6:06:59 PM
Nitrogen, Nitrate (As N)	11	1.0	*	mg/L	10	5/26/2023 6:06:59 PM
SM2540C MOD: TOTAL DISSOLVED SOLIDS						Analyst: KS
Total Dissolved Solids	2230	100	*D	mg/L	1	6/1/2023 5:08:00 PM
SM 4500 NORG C: TKN						Analyst: DML
Nitrogen, Kjeldahl, Total	ND	2.0	D	mg/L	1	6/12/2023 9:20:00 AM

Refer to the QC Summary report and sample login checklist for flagged QC data and preservation information.

Qualifiers:	*	Value exceeds Maximum Contaminant Level.	B	Analyte detected in the associated Method Blank
	D	Sample Diluted Due to Matrix	E	Above Quantitation Range/Estimated Value
	H	Holding times for preparation or analysis exceeded	J	Analyte detected below quantitation limits
	ND	Not Detected at the Reporting Limit	P	Sample pH Not In Range
	PQL	Practical Quantitative Limit	RL	Reporting Limit
	S	% Recovery outside of standard limits. If undiluted results may be estimated.		

Hall Environmental Analysis Laboratory, Inc.

Analytical Report

Lab Order 2305D75

Date Reported: 6/14/2023

CLIENT: EA Engineering

Client Sample ID: DAD-11

Project: Dona Ana Dairies

Collection Date: 5/25/2023 4:25:00 PM

Lab ID: 2305D75-004

Matrix: GROUNDWA

Received Date: 5/26/2023 9:45:00 AM

Analyses	Result	RL	Qual	Units	DF	Date Analyzed
EPA METHOD 300.0: ANIONS						Analyst: JMT
Chloride	730	50	*	mg/L	100	5/26/2023 6:44:01 PM
Nitrogen, Nitrite (As N)	ND	1.0		mg/L	10	5/26/2023 6:31:40 PM
Nitrogen, Nitrate (As N)	17	1.0	*	mg/L	10	5/26/2023 6:31:40 PM
SM2540C MOD: TOTAL DISSOLVED SOLIDS						Analyst: KS
Total Dissolved Solids	3100	50.0	*	mg/L	1	6/1/2023 5:08:00 PM
SM 4500 NORG C: TKN						Analyst: DML
Nitrogen, Kjeldahl, Total	ND	2.0	D	mg/L	1	6/12/2023 9:20:00 AM

Refer to the QC Summary report and sample login checklist for flagged QC data and preservation information.

Qualifiers:	*	Value exceeds Maximum Contaminant Level.	B	Analyte detected in the associated Method Blank
	D	Sample Diluted Due to Matrix	E	Above Quantitation Range/Estimated Value
	H	Holding times for preparation or analysis exceeded	J	Analyte detected below quantitation limits
	ND	Not Detected at the Reporting Limit	P	Sample pH Not In Range
	PQL	Practical Quantitative Limit	RL	Reporting Limit
	S	% Recovery outside of standard limits. If undiluted results may be estimated.		

QC SUMMARY REPORT

Hall Environmental Analysis Laboratory, Inc.

WO#: 2305D75

14-Jun-23

Client: EA Engineering
Project: Dona Ana Dairies

Sample ID: MB	SampType: mblk	TestCode: EPA Method 300.0: Anions								
Client ID: PBW	Batch ID: R97070	RunNo: 97070								
Prep Date:	Analysis Date: 5/26/2023	SeqNo: 3523008 Units: mg/L								
Analyte	Result	PQL	SPK value	SPK Ref Val	%REC	LowLimit	HighLimit	%RPD	RPDLimit	Qual

Chloride	ND	0.50								
Nitrogen, Nitrite (As N)	ND	0.10								
Nitrogen, Nitrate (As N)	ND	0.10								

Sample ID: LCS	SampType: ics	TestCode: EPA Method 300.0: Anions								
Client ID: LCSW	Batch ID: R97070	RunNo: 97070								
Prep Date:	Analysis Date: 5/26/2023	SeqNo: 3523009 Units: mg/L								
Analyte	Result	PQL	SPK value	SPK Ref Val	%REC	LowLimit	HighLimit	%RPD	RPDLimit	Qual

Chloride	4.6	0.50	5.000	0	92.6	90	110			
Nitrogen, Nitrite (As N)	0.94	0.10	1.000	0	93.6	90	110			
Nitrogen, Nitrate (As N)	2.4	0.10	2.500	0	97.4	90	110			

Qualifiers:

* Value exceeds Maximum Contaminant Level.	B Analyte detected in the associated Method Blank
D Sample Diluted Due to Matrix	E Above Quantitation Range/Estimated Value
H Holding times for preparation or analysis exceeded	J Analyte detected below quantitation limits
ND Not Detected at the Reporting Limit	P Sample pH Not In Range
PQL Practical Quantitative Limit	RL Reporting Limit
S % Recovery outside of standard limits. If undiluted results may be estimated.	

QC SUMMARY REPORT

Hall Environmental Analysis Laboratory, Inc.

WO#: 2305D75

14-Jun-23

Client: EA Engineering
Project: Dona Ana Dairies

Sample ID: MB-75259	SampType: MBLK	TestCode: SM2540C MOD: Total Dissolved Solids								
Client ID: PBW	Batch ID: 75259	RunNo: 97152								
Prep Date: 5/31/2023	Analysis Date: 6/1/2023	SeqNo: 3527734	Units: mg/L							
Analyte	Result	PQL	SPK value	SPK Ref Val	%REC	LowLimit	HighLimit	%RPD	RPDLimit	Qual
Total Dissolved Solids	ND	50.0								

Sample ID: LCS-75259	SampType: LCS	TestCode: SM2540C MOD: Total Dissolved Solids								
Client ID: LCSW	Batch ID: 75259	RunNo: 97152								
Prep Date: 5/31/2023	Analysis Date: 6/1/2023	SeqNo: 3527735	Units: mg/L							
Analyte	Result	PQL	SPK value	SPK Ref Val	%REC	LowLimit	HighLimit	%RPD	RPDLimit	Qual
Total Dissolved Solids	991	50.0	1000	0	99.1	80	120			

Qualifiers:

- | | |
|---|---|
| * Value exceeds Maximum Contaminant Level. | B Analyte detected in the associated Method Blank |
| D Sample Diluted Due to Matrix | E Above Quantitation Range/Estimated Value |
| H Holding times for preparation or analysis exceeded | J Analyte detected below quantitation limits |
| ND Not Detected at the Reporting Limit | P Sample pH Not In Range |
| PQL Practical Quantitative Limit | RL Reporting Limit |
| S % Recovery outside of standard limits. If undiluted results may be estimated. | |

QC SUMMARY REPORT

Hall Environmental Analysis Laboratory, Inc.

WO#: 2305D75

14-Jun-23

Client: EA Engineering
Project: Dona Ana Dairies

Sample ID: MB-75383	SampType: MBLK	TestCode: SM 4500 Norg C: TKN								
Client ID: PBW	Batch ID: 75383	RunNo: 97265								
Prep Date: 6/6/2023	Analysis Date: 6/7/2023	SeqNo: 3532942	Units: mg/L							
Analyte	Result	PQL	SPK value	SPK Ref Val	%REC	LowLimit	HighLimit	%RPD	RPDLimit	Qual
Nitrogen, Kjeldahl, Total	ND	1.0								

Sample ID: LCS-75383	SampType: LCS	TestCode: SM 4500 Norg C: TKN								
Client ID: LCSW	Batch ID: 75383	RunNo: 97265								
Prep Date: 6/6/2023	Analysis Date: 6/7/2023	SeqNo: 3532943	Units: mg/L							
Analyte	Result	PQL	SPK value	SPK Ref Val	%REC	LowLimit	HighLimit	%RPD	RPDLimit	Qual
Nitrogen, Kjeldahl, Total	10	1.0	10.00	0	101	80	120			

Sample ID: MB-75384	SampType: MBLK	TestCode: SM 4500 Norg C: TKN								
Client ID: PBW	Batch ID: 75384	RunNo: 97316								
Prep Date: 6/6/2023	Analysis Date: 6/9/2023	SeqNo: 3535306	Units: mg/L							
Analyte	Result	PQL	SPK value	SPK Ref Val	%REC	LowLimit	HighLimit	%RPD	RPDLimit	Qual
Nitrogen, Kjeldahl, Total	ND	1.0								

Sample ID: LCS-75384	SampType: LCS	TestCode: SM 4500 Norg C: TKN								
Client ID: LCSW	Batch ID: 75384	RunNo: 97316								
Prep Date: 6/6/2023	Analysis Date: 6/9/2023	SeqNo: 3535307	Units: mg/L							
Analyte	Result	PQL	SPK value	SPK Ref Val	%REC	LowLimit	HighLimit	%RPD	RPDLimit	Qual
Nitrogen, Kjeldahl, Total	9.8	1.0	10.00	0	98.0	80	120			

Sample ID: MB-75410	SampType: MBLK	TestCode: SM 4500 Norg C: TKN								
Client ID: PBW	Batch ID: 75410	RunNo: 97365								
Prep Date: 6/7/2023	Analysis Date: 6/12/2023	SeqNo: 3537322	Units: mg/L							
Analyte	Result	PQL	SPK value	SPK Ref Val	%REC	LowLimit	HighLimit	%RPD	RPDLimit	Qual
Nitrogen, Kjeldahl, Total	ND	1.0								

Sample ID: LCS-75410	SampType: LCS	TestCode: SM 4500 Norg C: TKN								
Client ID: LCSW	Batch ID: 75410	RunNo: 97365								
Prep Date: 6/7/2023	Analysis Date: 6/12/2023	SeqNo: 3537323	Units: mg/L							
Analyte	Result	PQL	SPK value	SPK Ref Val	%REC	LowLimit	HighLimit	%RPD	RPDLimit	Qual
Nitrogen, Kjeldahl, Total	10	1.0	10.00	0	101	80	120			

Qualifiers:

- * Value exceeds Maximum Contaminant Level.
- D Sample Diluted Due to Matrix
- H Holding times for preparation or analysis exceeded
- ND Not Detected at the Reporting Limit
- PQL Practical Quantitative Limit
- S % Recovery outside of standard limits. If undiluted results may be estimated.
- B Analyte detected in the associated Method Blank
- E Above Quantitation Range/Estimated Value
- J Analyte detected below quantitation limits
- P Sample pH Not In Range
- RL Reporting Limit

Sample Log-In Check List

Client Name: EA Engineering

Work Order Number: 2305D75

RcptNo: 1

Received By: Desiree Dominguez 5/26/2023 9:45:00 AM *DD*

Completed By: Desiree Dominguez 5/26/2023 9:50:18 AM *DD*

Reviewed By: *JM 5/26/23*

Chain of Custody

1. Is Chain of Custody complete? Yes No Not Present

2. How was the sample delivered? FedEx

Log In

3. Was an attempt made to cool the samples? Yes No NA

4. Were all samples received at a temperature of >0° C to 6.0°C Yes No NA

5. Sample(s) in proper container(s)? Yes No
Approved by client.

6. Sufficient sample volume for indicated test(s)? Yes No

7. Are samples (except VOA and ONG) properly preserved? Yes No

8. Was preservative added to bottles? Yes No NA

9. Received at least 1 vial with headspace <1/4" for AQ VOA? Yes No NA

10. Were any sample containers received broken? Yes No

11. Does paperwork match bottle labels? Yes No
 (Note discrepancies on chain of custody)

12. Are matrices correctly identified on Chain of Custody? Yes No

13. Is it clear what analyses were requested? Yes No

14. Were all holding times able to be met? Yes No
 (If no, notify customer for authorization.)

of preserved bottles checked for pH: 4 or >12 unless noted)
 Adjusted? NO
 Checked by: *JM 5-26-23*
pH strip lot # 538534

Special Handling (if applicable)

15. Was client notified of all discrepancies with this order? Yes No NA

Person Notified:	_____	Date:	_____
By Whom:	_____	Via:	<input type="checkbox"/> eMail <input type="checkbox"/> Phone <input type="checkbox"/> Fax <input type="checkbox"/> In Person
Regarding:	_____		
Client Instructions:	_____		

16. Additional remarks:

17. Cooler Information

Cooler No	Temp °C	Condition	Seal Intact	Seal No	Seal Date	Signed By
1	0.0	Good	Not Present	Yogi		

Chain-of-Custody Record

Client: _____
 EA Engineering, Science, and Technology
 Mailing Address: _____
 320 Gold Ave SW Suite _____
 Phone #: 505-715-4279
 email or Fax#: rmullen@east.com

QA/QC Package: Standard Level 4 (Full Validation)
 Accreditation: Az Compliance
 NELAC Other _____
 EDD (Type) _____

Date	Time	Matrix	Sample Name
5-25	16:31	Gw	DAD-01
5-25	12:20	Gw	DAD-12
5-25	14:02	Gw	DAD-13
5-25	16:25	Gw	DAD-11

Turn-Around Time: Standard Rush
 Project Name: _____
 Dona Ana Dairies (DAD's)
 Project #: _____
 Project Manager: Gina Mullen
 Sampler: Angel N. Rivera
 On Ice: Yes No
 # of Coolers: 1
 Cooler Temp (including CF): 0.2 - 0.2 = 0.0°C
 Container Type and #
 Preservative Type
 HEAL No.
 2305D75
 -001
 -002
 -003
 -004

Received by: *[Signature]* Date: 5/26/23 Time: 9:45
 Received by: _____ Date: _____ Time: _____

Project Name: _____
 Dona Ana Dairies (DAD's)
 Project #: _____
 Project Manager: Gina Mullen
 Sampler: Angel N. Rivera
 On Ice: Yes No
 # of Coolers: 1
 Cooler Temp (including CF): 0.2 - 0.2 = 0.0°C

QA/QC Package: Standard Level 4 (Full Validation)
 Accreditation: Az Compliance
 NELAC Other _____
 EDD (Type) _____

Date	Time	Matrix	Sample Name
5-25	16:31	Gw	DAD-01
5-25	12:20	Gw	DAD-12
5-25	14:02	Gw	DAD-13
5-25	16:25	Gw	DAD-11

Turn-Around Time: Standard Rush
 Project Name: _____
 Dona Ana Dairies (DAD's)
 Project #: _____
 Project Manager: Gina Mullen
 Sampler: Angel N. Rivera
 On Ice: Yes No
 # of Coolers: 1
 Cooler Temp (including CF): 0.2 - 0.2 = 0.0°C
 Container Type and #
 Preservative Type
 HEAL No.
 2305D75
 -001
 -002
 -003
 -004

Received by: *[Signature]* Date: 5/26/23 Time: 9:45
 Received by: _____ Date: _____ Time: _____

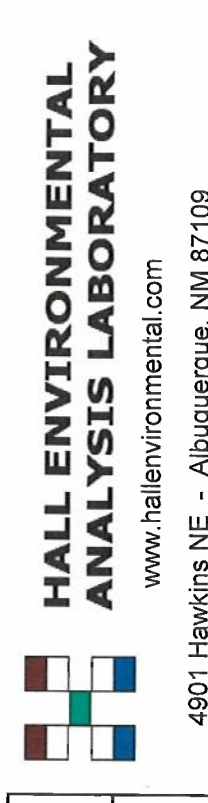

HALL ENVIRONMENTAL ANALYSIS LABORATORY
 www.hallenvironmental.com
 4901 Hawkins NE - Albuquerque, NM 87109
 Tel. 505-345-3975 Fax 505-345-4107

Analysis Request
 Nitrate/Nitrites EPA Method 300
 TKN SM 4500 NORG C
 Chloride EPA 300
 TDS SM 2540 C MOD
 Sulfate EPA 300
 Phosphorus EPA 6010B
 Total Sulfur

Analysis Request	Nitrate/Nitrites EPA Method 300	TKN SM 4500 NORG C	Chloride EPA 300	TDS SM 2540 C MOD	Sulfate EPA 300	Phosphorus EPA 6010B	Total Sulfur
	X	X	X	X			
	X	X	X	X			
	X	X	X	X			
	X	X	X	X			

Remarks: _____

If necessary, samples submitted to Hall Environmental may be subcontracted to other accredited laboratories. This serves as notice of this possibility. Any sub-contracted data will be clearly notated on the analytical report.



Hall Environmental Analysis Laboratory
4901 Hawkins NE
Albuquerque, NM 87109
TEL: 505-345-3975 FAX: 505-345-4107
Website: www.hallenvironmental.com

June 14, 2023

Regina Mullen
EA Engineering
320 Gold Ave SW Suite 1210
Albuquerque, NM 87102
TEL:
FAX

RE: Dona Ana Dairies

OrderNo.: 2305E19

Dear Regina Mullen:

Hall Environmental Analysis Laboratory received 4 sample(s) on 5/27/2023 for the analyses presented in the following report.

These were analyzed according to EPA procedures or equivalent. To access our accredited tests please go to www.hallenvironmental.com or the state specific web sites. In order to properly interpret your results, it is imperative that you review this report in its entirety. See the sample checklist and/or the Chain of Custody for information regarding the sample receipt temperature and preservation. Data qualifiers or a narrative will be provided if the sample analysis or analytical quality control parameters require a flag. When necessary, data qualifiers are provided on both the sample analysis report and the QC summary report, both sections should be reviewed. All samples are reported, as received, unless otherwise indicated. Lab measurement of analytes considered field parameters that require analysis within 15 minutes of sampling such as pH and residual chlorine are qualified as being analyzed outside of the recommended holding time.

Please don't hesitate to contact HEAL for any additional information or clarifications.

ADHS Cert #AZ0682 -- NMED-DWB Cert #NM9425 -- NMED-Micro Cert #NM0901

Sincerely,

A handwritten signature in black ink, appearing to read 'Andy Freeman', is written in a cursive style.

Andy Freeman
Laboratory Manager
4901 Hawkins NE
Albuquerque, NM 87109

Hall Environmental Analysis Laboratory, Inc.

Analytical Report

Lab Order 2305E19

Date Reported: 6/14/2023

CLIENT: EA Engineering

Client Sample ID: DAD-14

Project: Dona Ana Dairies

Collection Date: 5/26/2023 11:08:00 AM

Lab ID: 2305E19-001

Matrix: GROUNDWA

Received Date: 5/27/2023 11:30:00 AM

Analyses	Result	RL	Qual	Units	DF	Date Analyzed
EPA METHOD 300.0: ANIONS						Analyst: SNS
Chloride	1200	50	*	mg/L	100	5/30/2023 2:02:44 PM
Nitrate+Nitrite as N	60	2.0	*	mg/L	10	6/6/2023 12:24:55 PM
SM2540C MOD: TOTAL DISSOLVED SOLIDS						Analyst: KS
Total Dissolved Solids	3830	50.0	*	mg/L	1	6/2/2023 3:05:00 PM
SM 4500 NORG C: TKN						Analyst: DML
Nitrogen, Kjeldahl, Total	ND	5.0	D	mg/L	1	6/12/2023 9:20:00 AM

Refer to the QC Summary report and sample login checklist for flagged QC data and preservation information.

Qualifiers:	* Value exceeds Maximum Contaminant Level.	B Analyte detected in the associated Method Blank
	D Sample Diluted Due to Matrix	E Above Quantitation Range/Estimated Value
	H Holding times for preparation or analysis exceeded	J Analyte detected below quantitation limits
	ND Not Detected at the Reporting Limit	P Sample pH Not In Range
	PQL Practical Quantitative Limit	RL Reporting Limit
	S % Recovery outside of standard limits. If undiluted results may be estimated.	

Hall Environmental Analysis Laboratory, Inc.

Analytical Report

Lab Order 2305E19

Date Reported: 6/14/2023

CLIENT: EA Engineering

Client Sample ID: DAD-23

Project: Dona Ana Dairies

Collection Date: 5/26/2023 12:35:00 PM

Lab ID: 2305E19-002

Matrix: GROUNDWA

Received Date: 5/27/2023 11:30:00 AM

Analyses	Result	RL	Qual	Units	DF	Date Analyzed
EPA METHOD 300.0: ANIONS						Analyst: SNS
Chloride	370	50	*	mg/L	100	5/30/2023 2:28:29 PM
Nitrate+Nitrite as N	18	1.0	*	mg/L	5	5/30/2023 4:11:25 PM
SM2540C MOD: TOTAL DISSOLVED SOLIDS						Analyst: KS
Total Dissolved Solids	1730	100	*D	mg/L	1	6/2/2023 3:05:00 PM
SM 4500 NORG C: TKN						Analyst: DML
Nitrogen, Kjeldahl, Total	ND	2.0	D	mg/L	1	6/12/2023 9:20:00 AM

Refer to the QC Summary report and sample login checklist for flagged QC data and preservation information.

Qualifiers:	*	Value exceeds Maximum Contaminant Level.	B	Analyte detected in the associated Method Blank
	D	Sample Diluted Due to Matrix	E	Above Quantitation Range/Estimated Value
	H	Holding times for preparation or analysis exceeded	J	Analyte detected below quantitation limits
	ND	Not Detected at the Reporting Limit	P	Sample pH Not In Range
	PQL	Practical Quantitative Limit	RL	Reporting Limit
	S	% Recovery outside of standard limits. If undiluted results may be estimated.		

Hall Environmental Analysis Laboratory, Inc.

Analytical Report

Lab Order 2305E19

Date Reported: 6/14/2023

CLIENT: EA Engineering

Client Sample ID: DAD-02

Project: Dona Ana Dairies

Collection Date: 5/26/2023 1:30:00 PM

Lab ID: 2305E19-003

Matrix: GROUNDWA

Received Date: 5/27/2023 11:30:00 AM

Analyses	Result	RL	Qual	Units	DF	Date Analyzed
EPA METHOD 300.0: ANIONS						Analyst: SNS
Chloride	460	50	*	mg/L	100	5/30/2023 3:19:57 PM
Nitrate+Nitrite as N	8.4	1.0		mg/L	5	5/30/2023 4:24:17 PM
SM2540C MOD: TOTAL DISSOLVED SOLIDS						Analyst: KS
Total Dissolved Solids	1610	500	*D	mg/L	1	6/2/2023 3:05:00 PM
SM 4500 NORG C: TKN						Analyst: DML
Nitrogen, Kjeldahl, Total	ND	2.0	D	mg/L	1	6/12/2023 9:20:00 AM

Refer to the QC Summary report and sample login checklist for flagged QC data and preservation information.

Qualifiers:	*	Value exceeds Maximum Contaminant Level.	B	Analyte detected in the associated Method Blank
	D	Sample Diluted Due to Matrix	E	Above Quantitation Range/Estimated Value
	H	Holding times for preparation or analysis exceeded	J	Analyte detected below quantitation limits
	ND	Not Detected at the Reporting Limit	P	Sample pH Not In Range
	PQL	Practical Quantitative Limit	RL	Reporting Limit
	S	% Recovery outside of standard limits. If undiluted results may be estimated.		

Hall Environmental Analysis Laboratory, Inc.

Analytical Report

Lab Order 2305E19

Date Reported: 6/14/2023

CLIENT: EA Engineering

Client Sample ID: DAD-03

Project: Dona Ana Dairies

Collection Date: 5/26/2023 3:25:00 PM

Lab ID: 2305E19-004

Matrix: GROUNDWA

Received Date: 5/27/2023 11:30:00 AM

Analyses	Result	RL	Qual	Units	DF	Date Analyzed
EPA METHOD 300.0: ANIONS						Analyst: SNS
Chloride	310	50	*	mg/L	100	5/30/2023 3:45:40 PM
Nitrate+Nitrite as N	ND	1.0		mg/L	5	5/30/2023 4:37:08 PM
SM2540C MOD: TOTAL DISSOLVED SOLIDS						Analyst: KS
Total Dissolved Solids	1770	500	*D	mg/L	1	6/2/2023 3:05:00 PM
SM 4500 NORG C: TKN						Analyst: DML
Nitrogen, Kjeldahl, Total	ND	1.0		mg/L	1	6/12/2023 9:20:00 AM

Refer to the QC Summary report and sample login checklist for flagged QC data and preservation information.

Qualifiers:

- | | | | |
|-----|---|----|---|
| * | Value exceeds Maximum Contaminant Level. | B | Analyte detected in the associated Method Blank |
| D | Sample Diluted Due to Matrix | E | Above Quantitation Range/Estimated Value |
| H | Holding times for preparation or analysis exceeded | J | Analyte detected below quantitation limits |
| ND | Not Detected at the Reporting Limit | P | Sample pH Not In Range |
| PQL | Practical Quantitative Limit | RL | Reporting Limit |
| S | % Recovery outside of standard limits. If undiluted results may be estimated. | | |

QC SUMMARY REPORT

Hall Environmental Analysis Laboratory, Inc.

WO#: 2305E19

14-Jun-23

Client: EA Engineering
Project: Dona Ana Dairies

Sample ID: MB	SampType: MBLK	TestCode: EPA Method 300.0: Anions								
Client ID: PBW	Batch ID: R97100	RunNo: 97100								
Prep Date:	Analysis Date: 5/30/2023	SeqNo: 3525073	Units: mg/L							
Analyte	Result	PQL	SPK value	SPK Ref Val	%REC	LowLimit	HighLimit	%RPD	RPDLimit	Qual
Chloride	ND	0.50								
Nitrate+Nitrite as N	ND	0.20								

Sample ID: LCS	SampType: LCS	TestCode: EPA Method 300.0: Anions								
Client ID: LCSW	Batch ID: R97100	RunNo: 97100								
Prep Date:	Analysis Date: 5/30/2023	SeqNo: 3525074	Units: mg/L							
Analyte	Result	PQL	SPK value	SPK Ref Val	%REC	LowLimit	HighLimit	%RPD	RPDLimit	Qual
Chloride	4.6	0.50	5.000	0	92.3	90	110			
Nitrate+Nitrite as N	3.4	0.20	3.500	0	97.6	90	110			

Sample ID: MB	SampType: mblk	TestCode: EPA Method 300.0: Anions								
Client ID: PBW	Batch ID: R97258	RunNo: 97258								
Prep Date:	Analysis Date: 6/6/2023	SeqNo: 3532508	Units: mg/L							
Analyte	Result	PQL	SPK value	SPK Ref Val	%REC	LowLimit	HighLimit	%RPD	RPDLimit	Qual
Nitrate+Nitrite as N	ND	0.20								

Sample ID: LCS	SampType: ics	TestCode: EPA Method 300.0: Anions								
Client ID: LCSW	Batch ID: R97258	RunNo: 97258								
Prep Date:	Analysis Date: 6/6/2023	SeqNo: 3532509	Units: mg/L							
Analyte	Result	PQL	SPK value	SPK Ref Val	%REC	LowLimit	HighLimit	%RPD	RPDLimit	Qual
Nitrate+Nitrite as N	3.5	0.20	3.500	0	99.8	90	110			

Sample ID: MB	SampType: mblk	TestCode: EPA Method 300.0: Anions								
Client ID: PBW	Batch ID: R97258	RunNo: 97258								
Prep Date:	Analysis Date: 6/6/2023	SeqNo: 3532555	Units: mg/L							
Analyte	Result	PQL	SPK value	SPK Ref Val	%REC	LowLimit	HighLimit	%RPD	RPDLimit	Qual
Nitrate+Nitrite as N	ND	0.20								

Sample ID: LCS	SampType: ics	TestCode: EPA Method 300.0: Anions								
Client ID: LCSW	Batch ID: R97258	RunNo: 97258								
Prep Date:	Analysis Date: 6/6/2023	SeqNo: 3532556	Units: mg/L							
Analyte	Result	PQL	SPK value	SPK Ref Val	%REC	LowLimit	HighLimit	%RPD	RPDLimit	Qual
Nitrate+Nitrite as N	3.5	0.20	3.500	0	101	90	110			

Qualifiers:

- * Value exceeds Maximum Contaminant Level.
- D Sample Diluted Due to Matrix
- H Holding times for preparation or analysis exceeded
- ND Not Detected at the Reporting Limit
- PQL Practical Quantitative Limit
- S % Recovery outside of standard limits. If undiluted results may be estimated.
- B Analyte detected in the associated Method Blank
- E Above Quantitation Range/Estimated Value
- J Analyte detected below quantitation limits
- P Sample pH Not In Range
- RL Reporting Limit

QC SUMMARY REPORT

Hall Environmental Analysis Laboratory, Inc.

WO#: 2305E19

14-Jun-23

Client: EA Engineering
Project: Dona Ana Dairies

Sample ID: MB-75284	SampType: MBLK	TestCode: SM2540C MOD: Total Dissolved Solids								
Client ID: PBW	Batch ID: 75284	RunNo: 97178								
Prep Date: 6/1/2023	Analysis Date: 6/2/2023	SeqNo: 3529220	Units: mg/L							
Analyte	Result	PQL	SPK value	SPK Ref Val	%REC	LowLimit	HighLimit	%RPD	RPDLimit	Qual
Total Dissolved Solids	ND	50.0								

Sample ID: LCS-75284	SampType: LCS	TestCode: SM2540C MOD: Total Dissolved Solids								
Client ID: LCSW	Batch ID: 75284	RunNo: 97178								
Prep Date: 6/1/2023	Analysis Date: 6/2/2023	SeqNo: 3529221	Units: mg/L							
Analyte	Result	PQL	SPK value	SPK Ref Val	%REC	LowLimit	HighLimit	%RPD	RPDLimit	Qual
Total Dissolved Solids	989	50.0	1000	0	98.9	80	120			

Sample ID: 2305E19-001ADUP	SampType: DUP	TestCode: SM2540C MOD: Total Dissolved Solids								
Client ID: DAD-14	Batch ID: 75284	RunNo: 97178								
Prep Date: 6/1/2023	Analysis Date: 6/2/2023	SeqNo: 3529223	Units: mg/L							
Analyte	Result	PQL	SPK value	SPK Ref Val	%REC	LowLimit	HighLimit	%RPD	RPDLimit	Qual
Total Dissolved Solids	3760	50.0						1.71	10	*

Qualifiers:

- * Value exceeds Maximum Contaminant Level.
- D Sample Diluted Due to Matrix
- H Holding times for preparation or analysis exceeded
- ND Not Detected at the Reporting Limit
- PQL Practical Quantitative Limit
- S % Recovery outside of standard limits. If undiluted results may be estimated.
- B Analyte detected in the associated Method Blank
- E Above Quantitation Range/Estimated Value
- J Analyte detected below quantitation limits
- P Sample pH Not In Range
- RL Reporting Limit

QC SUMMARY REPORT

Hall Environmental Analysis Laboratory, Inc.

WO#: 2305E19

14-Jun-23

Client: EA Engineering
Project: Dona Ana Dairies

Sample ID: MB-75410	SampType: MBLK	TestCode: SM 4500 Norg C: TKN								
Client ID: PBW	Batch ID: 75410	RunNo: 97365								
Prep Date: 6/7/2023	Analysis Date: 6/12/2023	SeqNo: 3537322 Units: mg/L								
Analyte	Result	PQL	SPK value	SPK Ref Val	%REC	LowLimit	HighLimit	%RPD	RPDLimit	Qual
Nitrogen, Kjeldahl, Total	ND	1.0								

Sample ID: LCS-75410	SampType: LCS	TestCode: SM 4500 Norg C: TKN								
Client ID: LCSW	Batch ID: 75410	RunNo: 97365								
Prep Date: 6/7/2023	Analysis Date: 6/12/2023	SeqNo: 3537323 Units: mg/L								
Analyte	Result	PQL	SPK value	SPK Ref Val	%REC	LowLimit	HighLimit	%RPD	RPDLimit	Qual
Nitrogen, Kjeldahl, Total	10	1.0	10.00	0	101	80	120			

Qualifiers:

*	Value exceeds Maximum Contaminant Level.	B	Analyte detected in the associated Method Blank
D	Sample Diluted Due to Matrix	E	Above Quantitation Range/Estimated Value
H	Holding times for preparation or analysis exceeded	J	Analyte detected below quantitation limits
ND	Not Detected at the Reporting Limit	P	Sample pH Not In Range
PQL	Practical Quantitative Limit	RL	Reporting Limit
S	% Recovery outside of standard limits. If undiluted results may be estimated.		

Sample Log-In Check List

Client Name: EA Engineering

Work Order Number: 2305E19

RcptNo: 1

Received By: Tracy Casarrubias 5/27/2023 11:30:00 AM

Completed By: Tracy Casarrubias 5/27/2023 12:56:05 PM

Reviewed By: *ms/30/23*

Chain of Custody

1. Is Chain of Custody complete? Yes No Not Present
2. How was the sample delivered? FedEx

Log In

3. Was an attempt made to cool the samples? Yes No NA
4. Were all samples received at a temperature of >0° C to 6.0°C Yes No NA
5. Sample(s) in proper container(s)? Yes No
6. Sufficient sample volume for indicated test(s)? Yes No
7. Are samples (except VOA and ONG) properly preserved? Yes No
8. Was preservative added to bottles? Yes No NA
9. Received at least 1 vial with headspace <1/4" for AQ VOA? Yes No NA
10. Were any sample containers received broken? Yes No
11. Does paperwork match bottle labels? Yes No
 (Note discrepancies on chain of custody)
12. Are matrices correctly identified on Chain of Custody? Yes No
13. Is it clear what analyses were requested? Yes No
14. Were all holding times able to be met? Yes No
 (If no, notify customer for authorization.)

of preserved bottles checked for pH: 4
 (<2 or >12 unless noted)
 Adjusted? NO
 Checked by: TMC 5/27/23
L2 Lot # 538534

Special Handling (if applicable)

15. Was client notified of all discrepancies with this order? Yes No NA

Person Notified: _____ Date: _____
 By Whom: _____ Via: eMail Phone Fax In Person
 Regarding: _____
 Client Instructions: _____

16. Additional remarks:

17. Cooler Information

Cooler No	Temp °C	Condition	Seal Intact	Seal No	Seal Date	Signed By
1	0.7	Good	Not Present	Yogi		

Chain-of-Custody Record

Client: EA Engineering, Science, and Technology
 Mailing Address: 320 Gold Ave SW Suite
 Phone #: 505-715-4279
 email or Fax#: rmullen@eaeest.com
 QA/QC Package: Standard Level 4 (Full Validation)
 Accreditation: Az Compliance Nelac Other
 EDD (Type) _____

Date	Time	Matrix	Sample Name
5-26	11:08	GW	DAD-14
5-26	12:35	GW	DAD-23
5-26	13:30	GW	DAD-02
5-26	15:25	GW	DAD-03

Turn-Around Time: Standard Rush
 Project Name: Dona Ana Dairies (DAD'S)
 Project #: _____
 Project Manager: Gina Mullen
 Sampler: Angel N. Rivera
 On Ice: Yes No
 # of Coolers: _____
 Cooler Temp (including CF): 0.9 - 0.2 = 0.7

Container Type and #	Preservative Type	HEAL No.
2		7305E19
2		001
2		002
2		003
2		004



HALL ENVIRONMENTAL ANALYSIS LABORATORY
Narragansett
 www.hallenvironmental.com

4901 Hawkins NE - Albuquerque, NM 87109
 Tel. 505-345-3975 Fax 505-345-4107

Analysis Request										
Nitrate/Nitrites EPA Method 300	TKN SM 4500 NORG C	Chloride EPA 300	TDS SM 2540 C MOD	Sulfate EPA 300	Phosphorus EPA 6010B	Total Sulfur				
X	X	X	X							
X	X	X	X							
X	X	X	X							
X	X	X	X							

Received by: Feder Date: 5/26/23 Time: 11:30
 Relinquished by: [Signature] Date: _____ Time: _____

If necessary, samples submitted to Hall Environmental may be subcontracted to other accredited laboratories. This serves as notice of this possibility. Any sub-contracted data will be clearly notated on the analytical report.



Hall Environmental Analysis Laboratory
4901 Hawkins NE
Albuquerque, NM 87109
TEL: 505-345-3975 FAX: 505-345-4107
Website: www.hallenvironmental.com

June 14, 2023

Regina Mullen
EA Engineering
320 Gold Ave SW Suite 1210
Albuquerque, NM 87102
TEL:
FAX

RE: Dona Ana Dairies

OrderNo.: 2305E59

Dear Regina Mullen:

Hall Environmental Analysis Laboratory received 3 sample(s) on 5/31/2023 for the analyses presented in the following report.

These were analyzed according to EPA procedures or equivalent. To access our accredited tests please go to www.hallenvironmental.com or the state specific web sites. In order to properly interpret your results, it is imperative that you review this report in its entirety. See the sample checklist and/or the Chain of Custody for information regarding the sample receipt temperature and preservation. Data qualifiers or a narrative will be provided if the sample analysis or analytical quality control parameters require a flag. When necessary, data qualifiers are provided on both the sample analysis report and the QC summary report, both sections should be reviewed. All samples are reported, as received, unless otherwise indicated. Lab measurement of analytes considered field parameters that require analysis within 15 minutes of sampling such as pH and residual chlorine are qualified as being analyzed outside of the recommended holding time.

Please don't hesitate to contact HEAL for any additional information or clarifications.

ADHS Cert #AZ0682 -- NMED-DWB Cert #NM9425 -- NMED-Micro Cert #NM0901

Sincerely,

A handwritten signature in black ink, appearing to read "Andy Freeman", is written in a cursive style.

Andy Freeman
Laboratory Manager
4901 Hawkins NE
Albuquerque, NM 87109

Hall Environmental Analysis Laboratory, Inc.

Analytical Report

Lab Order 2305E59

Date Reported: 6/14/2023

CLIENT: EA Engineering

Client Sample ID: DAD-15

Project: Dona Ana Dairies

Collection Date: 5/30/2023 11:18:00 AM

Lab ID: 2305E59-001

Matrix: GROUNDWA

Received Date: 5/31/2023 8:45:00 AM

Analyses	Result	RL	Qual	Units	DF	Date Analyzed
EPA METHOD 300.0: ANIONS						Analyst: SNS
Chloride	640	50	*	mg/L	100	5/31/2023 3:26:05 PM
Nitrogen, Nitrite (As N)	ND	1.0		mg/L	10	5/31/2023 2:49:03 PM
Nitrogen, Nitrate (As N)	15	1.0	*	mg/L	10	5/31/2023 2:49:03 PM
SM2540C MOD: TOTAL DISSOLVED SOLIDS						Analyst: KS
Total Dissolved Solids	2320	100	*D	mg/L	1	6/2/2023 3:05:00 PM
SM 4500 NORG C: TKN						Analyst: DML
Nitrogen, Kjeldahl, Total	ND	2.0	D	mg/L	1	6/12/2023 12:44:00 PM

Refer to the QC Summary report and sample login checklist for flagged QC data and preservation information.

Qualifiers:	*	Value exceeds Maximum Contaminant Level.	B	Analyte detected in the associated Method Blank
	D	Sample Diluted Due to Matrix	E	Above Quantitation Range/Estimated Value
	H	Holding times for preparation or analysis exceeded	J	Analyte detected below quantitation limits
	ND	Not Detected at the Reporting Limit	P	Sample pH Not In Range
	PQL	Practical Quantitative Limit	RL	Reporting Limit
	S	% Recovery outside of standard limits. If undiluted results may be estimated.		

Hall Environmental Analysis Laboratory, Inc.

Analytical Report

Lab Order 2305E59

Date Reported: 6/14/2023

CLIENT: EA Engineering

Client Sample ID: DAD-16

Project: Dona Ana Dairies

Collection Date: 5/30/2023 1:31:00 PM

Lab ID: 2305E59-002

Matrix: GROUNDWA

Received Date: 5/31/2023 8:45:00 AM

Analyses	Result	RL	Qual	Units	DF	Date Analyzed
EPA METHOD 300.0: ANIONS						Analyst: SNS
Chloride	330	50	*	mg/L	100	5/31/2023 3:50:46 PM
Nitrogen, Nitrite (As N)	ND	1.0		mg/L	10	5/31/2023 3:38:26 PM
Nitrogen, Nitrate (As N)	ND	1.0		mg/L	10	5/31/2023 3:38:26 PM
SM2540C MOD: TOTAL DISSOLVED SOLIDS						Analyst: KS
Total Dissolved Solids	1760	100	*D	mg/L	1	6/2/2023 3:05:00 PM
SM 4500 NORG C: TKN						Analyst: DML
Nitrogen, Kjeldahl, Total	ND	1.0		mg/L	1	6/12/2023 12:44:00 PM

Refer to the QC Summary report and sample login checklist for flagged QC data and preservation information.

Qualifiers:	* Value exceeds Maximum Contaminant Level.	B Analyte detected in the associated Method Blank
	D Sample Diluted Due to Matrix	E Above Quantitation Range/Estimated Value
	H Holding times for preparation or analysis exceeded	J Analyte detected below quantitation limits
	ND Not Detected at the Reporting Limit	P Sample pH Not In Range
	PQL Practical Quantitative Limit	RL Reporting Limit
	S % Recovery outside of standard limits. If undiluted results may be estimated.	

Hall Environmental Analysis Laboratory, Inc.

Analytical Report

Lab Order 2305E59

Date Reported: 6/14/2023

CLIENT: EA Engineering

Client Sample ID: DAD-06R

Project: Dona Ana Dairies

Collection Date: 5/30/2023 3:50:00 PM

Lab ID: 2305E59-003

Matrix: GROUNDWA

Received Date: 5/31/2023 8:45:00 AM

Analyses	Result	RL	Qual	Units	DF	Date Analyzed
EPA METHOD 300.0: ANIONS						Analyst: SNS
Chloride	84	5.0		mg/L	10	5/31/2023 4:03:06 PM
Nitrogen, Nitrite (As N)	ND	1.0		mg/L	10	5/31/2023 4:03:06 PM
Nitrogen, Nitrate (As N)	6.4	1.0		mg/L	10	5/31/2023 4:03:06 PM
SM2540C MOD: TOTAL DISSOLVED SOLIDS						Analyst: KS
Total Dissolved Solids	580	250	*D	mg/L	1	6/2/2023 3:05:00 PM
SM 4500 NORG C: TKN						Analyst: DML
Nitrogen, Kjeldahl, Total	5.6	1.0		mg/L	1	6/12/2023 2:27:00 PM

Refer to the QC Summary report and sample login checklist for flagged QC data and preservation information.

Qualifiers:	* Value exceeds Maximum Contaminant Level.	B Analyte detected in the associated Method Blank
	D Sample Diluted Due to Matrix	E Above Quantitation Range/Estimated Value
	H Holding times for preparation or analysis exceeded	J Analyte detected below quantitation limits
	ND Not Detected at the Reporting Limit	P Sample pH Not In Range
	PQL Practical Quantitative Limit	RL Reporting Limit
	S % Recovery outside of standard limits. If undiluted results may be estimated.	

QC SUMMARY REPORT

Hall Environmental Analysis Laboratory, Inc.

WO#: 2305E59

14-Jun-23

Client: EA Engineering
Project: Dona Ana Dairies

Sample ID: MB	SampType: MBLK	TestCode: EPA Method 300.0: Anions								
Client ID: PBW	Batch ID: R97141	RunNo: 97141								
Prep Date:	Analysis Date: 5/31/2023	SeqNo: 3527278			Units: mg/L					
Analyte	Result	PQL	SPK value	SPK Ref Val	%REC	LowLimit	HighLimit	%RPD	RPDLimit	Qual

Chloride	ND	0.50								
Nitrogen, Nitrite (As N)	ND	0.10								
Nitrogen, Nitrate (As N)	ND	0.10								

Sample ID: LCS	SampType: LCS	TestCode: EPA Method 300.0: Anions								
Client ID: LCSW	Batch ID: R97141	RunNo: 97141								
Prep Date:	Analysis Date: 5/31/2023	SeqNo: 3527279			Units: mg/L					
Analyte	Result	PQL	SPK value	SPK Ref Val	%REC	LowLimit	HighLimit	%RPD	RPDLimit	Qual

Chloride	4.7	0.50	5.000	0	94.2	90	110			
Nitrogen, Nitrite (As N)	0.95	0.10	1.000	0	94.7	90	110			
Nitrogen, Nitrate (As N)	2.5	0.10	2.500	0	98.3	90	110			

Sample ID: 2305E59-001AMS	SampType: MS	TestCode: EPA Method 300.0: Anions								
Client ID: DAD-15	Batch ID: R97141	RunNo: 97141								
Prep Date:	Analysis Date: 5/31/2023	SeqNo: 3527301			Units: mg/L					
Analyte	Result	PQL	SPK value	SPK Ref Val	%REC	LowLimit	HighLimit	%RPD	RPDLimit	Qual

Nitrogen, Nitrite (As N)	8.9	1.0	10.00	0	89.5	83	110			
Nitrogen, Nitrate (As N)	40	1.0	25.00	15.04	99.6	89.8	110			

Sample ID: 2305E59-001AMSD	SampType: MSD	TestCode: EPA Method 300.0: Anions								
Client ID: DAD-15	Batch ID: R97141	RunNo: 97141								
Prep Date:	Analysis Date: 5/31/2023	SeqNo: 3527302			Units: mg/L					
Analyte	Result	PQL	SPK value	SPK Ref Val	%REC	LowLimit	HighLimit	%RPD	RPDLimit	Qual

Nitrogen, Nitrite (As N)	9.0	1.0	10.00	0	90.0	81	110	0.544	20	
Nitrogen, Nitrate (As N)	40	1.0	25.00	15.04	100	87.7	111	0.258	20	

Qualifiers:

- * Value exceeds Maximum Contaminant Level.
- D Sample Diluted Due to Matrix
- H Holding times for preparation or analysis exceeded
- ND Not Detected at the Reporting Limit
- PQL Practical Quantitative Limit
- S % Recovery outside of standard limits. If undiluted results may be estimated.
- B Analyte detected in the associated Method Blank
- E Above Quantitation Range/Estimated Value
- J Analyte detected below quantitation limits
- P Sample pH Not In Range
- RL Reporting Limit

QC SUMMARY REPORT

Hall Environmental Analysis Laboratory, Inc.

WO#: 2305E59

14-Jun-23

Client: EA Engineering
Project: Dona Ana Dairies

Sample ID: MB-75284	SampType: MBLK	TestCode: SM2540C MOD: Total Dissolved Solids								
Client ID: PBW	Batch ID: 75284	RunNo: 97178								
Prep Date: 6/1/2023	Analysis Date: 6/2/2023	SeqNo: 3529220	Units: mg/L							
Analyte	Result	PQL	SPK value	SPK Ref Val	%REC	LowLimit	HighLimit	%RPD	RPDLimit	Qual
Total Dissolved Solids	ND	50.0								

Sample ID: LCS-75284	SampType: LCS	TestCode: SM2540C MOD: Total Dissolved Solids								
Client ID: LCSW	Batch ID: 75284	RunNo: 97178								
Prep Date: 6/1/2023	Analysis Date: 6/2/2023	SeqNo: 3529221	Units: mg/L							
Analyte	Result	PQL	SPK value	SPK Ref Val	%REC	LowLimit	HighLimit	%RPD	RPDLimit	Qual
Total Dissolved Solids	989	50.0	1000	0	98.9	80	120			

Qualifiers:

- | | |
|---|---|
| * Value exceeds Maximum Contaminant Level. | B Analyte detected in the associated Method Blank |
| D Sample Diluted Due to Matrix | E Above Quantitation Range/Estimated Value |
| H Holding times for preparation or analysis exceeded | J Analyte detected below quantitation limits |
| ND Not Detected at the Reporting Limit | P Sample pH Not In Range |
| PQL Practical Quantitative Limit | RL Reporting Limit |
| S % Recovery outside of standard limits. If undiluted results may be estimated. | |

QC SUMMARY REPORT

Hall Environmental Analysis Laboratory, Inc.

WO#: 2305E59

14-Jun-23

Client: EA Engineering
Project: Dona Ana Dairies

Sample ID: MB-75462	SampType: MBLK	TestCode: SM 4500 Norg C: TKN								
Client ID: PBW	Batch ID: 75462	RunNo: 97379								
Prep Date: 6/8/2023	Analysis Date: 6/12/2023	SeqNo: 3537652	Units: mg/L							
Analyte	Result	PQL	SPK value	SPK Ref Val	%REC	LowLimit	HighLimit	%RPD	RPDLimit	Qual
Nitrogen, Kjeldahl, Total	ND	1.0								

Sample ID: LCS-75462	SampType: LCS	TestCode: SM 4500 Norg C: TKN								
Client ID: LCSW	Batch ID: 75462	RunNo: 97379								
Prep Date: 6/8/2023	Analysis Date: 6/12/2023	SeqNo: 3537653	Units: mg/L							
Analyte	Result	PQL	SPK value	SPK Ref Val	%REC	LowLimit	HighLimit	%RPD	RPDLimit	Qual
Nitrogen, Kjeldahl, Total	10	1.0	10.00	0	102	80	120			

Sample ID: MB-75487	SampType: MBLK	TestCode: SM 4500 Norg C: TKN								
Client ID: PBW	Batch ID: 75487	RunNo: 97380								
Prep Date: 6/9/2023	Analysis Date: 6/12/2023	SeqNo: 3537672	Units: mg/L							
Analyte	Result	PQL	SPK value	SPK Ref Val	%REC	LowLimit	HighLimit	%RPD	RPDLimit	Qual
Nitrogen, Kjeldahl, Total	ND	1.0								

Sample ID: LCS-75487	SampType: LCS	TestCode: SM 4500 Norg C: TKN								
Client ID: LCSW	Batch ID: 75487	RunNo: 97380								
Prep Date: 6/9/2023	Analysis Date: 6/12/2023	SeqNo: 3537673	Units: mg/L							
Analyte	Result	PQL	SPK value	SPK Ref Val	%REC	LowLimit	HighLimit	%RPD	RPDLimit	Qual
Nitrogen, Kjeldahl, Total	10	1.0	10.00	0	101	80	120			

Qualifiers:

- | | |
|---|---|
| * Value exceeds Maximum Contaminant Level. | B Analyte detected in the associated Method Blank |
| D Sample Diluted Due to Matrix | E Above Quantitation Range/Estimated Value |
| H Holding times for preparation or analysis exceeded | J Analyte detected below quantitation limits |
| ND Not Detected at the Reporting Limit | P Sample pH Not In Range |
| PQL Practical Quantitative Limit | RL Reporting Limit |
| S % Recovery outside of standard limits. If undiluted results may be estimated. | |



Sample Log-In Check List

Client Name: EA Engineering

Work Order Number: 2305E59

RcptNo: 1

Received By: Joseph Alderette 5/31/2023 8:45:00 AM

Completed By: Kasandra Jimena Garcia 5/31/2023 8:57:52 AM

Reviewed By: *WA 5/31/23*

JH
KJG

Chain of Custody

1. Is Chain of Custody complete? Yes No Not Present
2. How was the sample delivered? FedEx

Log In

3. Was an attempt made to cool the samples? Yes No NA
4. Were all samples received at a temperature of >0° C to 6.0°C Yes No NA
5. Sample(s) in proper container(s)? Yes No
6. Sufficient sample volume for indicated test(s)? Yes No
7. Are samples (except VOA and ONG) properly preserved? Yes No
8. Was preservative added to bottles? Yes No NA
9. Received at least 1 vial with headspace <1/4" for AQ VOA? Yes No NA
10. Were any sample containers received broken? Yes No
11. Does paperwork match bottle labels? (Note discrepancies on chain of custody) Yes No
12. Are matrices correctly identified on Chain of Custody? Yes No
13. Is it clear what analyses were requested? Yes No
14. Were all holding times able to be met? (If no, notify customer for authorization.) Yes No

of preserved bottles checked for pH: 3
 (<2 or >12 unless noted)
 Adjusted? NO
 Checked by: WA 5/31/23

Special Handling (if applicable)

15. Was client notified of all discrepancies with this order? Yes No NA

Person Notified:	<input type="text"/>	Date:	<input type="text"/>
By Whom:	<input type="text"/>	Via:	<input type="checkbox"/> eMail <input type="checkbox"/> Phone <input type="checkbox"/> Fax <input type="checkbox"/> In Person
Regarding:	<input type="text"/>		
Client Instructions:	<input type="text"/>		

16. Additional remarks:

17. **Cooler Information**

Cooler No	Temp °C	Condition	Seal Intact	Seal No	Seal Date	Signed By
1	0.4	Good	Not Present	YOGI		



Hall Environmental Analysis Laboratory
4901 Hawkins NE
Albuquerque, NM 87109
TEL: 505-345-3975 FAX: 505-345-4107
Website: www.hallenvironmental.com

May 15, 2023

Gina Mullen

EA Engineering

320 Gold Ave SW Suite 1210

Albuquerque, NM 87102

TEL:

FAX:

RE: Bright Star Dairy

OrderNo.: 2305358

Dear Gina Mullen:

Hall Environmental Analysis Laboratory received 3 sample(s) on 5/6/2023 for the analyses presented in the following report.

These were analyzed according to EPA procedures or equivalent. To access our accredited tests please go to www.hallenvironmental.com or the state specific web sites. In order to properly interpret your results, it is imperative that you review this report in its entirety. See the sample checklist and/or the Chain of Custody for information regarding the sample receipt temperature and preservation. Data qualifiers or a narrative will be provided if the sample analysis or analytical quality control parameters require a flag. When necessary, data qualifiers are provided on both the sample analysis report and the QC summary report, both sections should be reviewed. All samples are reported, as received, unless otherwise indicated. Lab measurement of analytes considered field parameters that require analysis within 15 minutes of sampling such as pH and residual chlorine are qualified as being analyzed outside of the recommended holding time.

Please don't hesitate to contact HEAL for any additional information or clarifications.

ADHS Cert #AZ0682 -- NMED-DWB Cert #NM9425 -- NMED-Micro Cert #NM0901

Sincerely,

A handwritten signature in black ink, appearing to read 'Andy Freeman', is written in a cursive style.

Andy Freeman

Laboratory Manager

4901 Hawkins NE

Albuquerque, NM 87109

Hall Environmental Analysis Laboratory, Inc.

Analytical Report

Lab Order 2305358

Date Reported: 5/15/2023

CLIENT: EA Engineering

Client Sample ID: 86/340-01

Project: Bright Star Dairy

Collection Date: 5/5/2023 10:54:00 AM

Lab ID: 2305358-001

Matrix: GROUNDWA

Received Date: 5/6/2023 11:00:00 AM

Analyses	Result	RL	Qual	Units	DF	Date Analyzed	Batch
EPA METHOD 300.0: ANIONS							Analyst: JMT
Chloride	270	50	*	mg/L	100	5/8/2023 4:47:10 PM	R96604
Sulfate	820	50	*	mg/L	100	5/8/2023 4:47:10 PM	R96604
Nitrate+Nitrite as N	2.9	1.0		mg/L	5	5/8/2023 7:34:20 PM	R96604
SM2540C MOD: TOTAL DISSOLVED SOLIDS							Analyst: RBC
Total Dissolved Solids	2220	100	*D	mg/L	1	5/10/2023 4:10:00 PM	74823
SM 4500 NORG C: TKN							Analyst: RBC
Nitrogen, Kjeldahl, Total	ND	1.0		mg/L	1	5/12/2023 2:36:00 PM	74922

Refer to the QC Summary report and sample login checklist for flagged QC data and preservation information.

Qualifiers:	*	Value exceeds Maximum Contaminant Level.	B	Analyte detected in the associated Method Blank
	D	Sample Diluted Due to Matrix	E	Above Quantitation Range/Estimated Value
	H	Holding times for preparation or analysis exceeded	J	Analyte detected below quantitation limits
	ND	Not Detected at the Reporting Limit	P	Sample pH Not In Range
	PQL	Practical Quantitative Limit	RL	Reporting Limit
	S	% Recovery outside of standard limits. If undiluted results may be estimated.		

Hall Environmental Analysis Laboratory, Inc.

Analytical Report

Lab Order 2305358

Date Reported: 5/15/2023

CLIENT: EA Engineering

Client Sample ID: 70/86/340-01

Project: Bright Star Dairy

Collection Date: 5/5/2023 1:05:00 PM

Lab ID: 2305358-002

Matrix: GROUNDWA

Received Date: 5/6/2023 11:00:00 AM

Analyses	Result	RL	Qual	Units	DF	Date Analyzed	Batch
EPA METHOD 300.0: ANIONS							Analyst: SNS
Chloride	1900	100	*	mg/L	200	5/12/2023 1:54:23 PM	R96710
Sulfate	1600	50	*	mg/L	100	5/8/2023 5:12:53 PM	R96604
Nitrate+Nitrite as N	24	1.0	*	mg/L	5	5/8/2023 7:47:12 PM	R96604
SM2540C MOD: TOTAL DISSOLVED SOLIDS							Analyst: RBC
Total Dissolved Solids	6060	250	*D	mg/L	1	5/10/2023 4:10:00 PM	74823
SM 4500 NORG C: TKN							Analyst: RBC
Nitrogen, Kjeldahl, Total	ND	5.0	D	mg/L	1	5/12/2023 2:36:00 PM	74922

Refer to the QC Summary report and sample login checklist for flagged QC data and preservation information.

Qualifiers:	*	Value exceeds Maximum Contaminant Level.	B	Analyte detected in the associated Method Blank
	D	Sample Diluted Due to Matrix	E	Above Quantitation Range/Estimated Value
	H	Holding times for preparation or analysis exceeded	J	Analyte detected below quantitation limits
	ND	Not Detected at the Reporting Limit	P	Sample pH Not In Range
	PQL	Practical Quantitative Limit	RL	Reporting Limit
	S	% Recovery outside of standard limits. If undiluted results may be estimated.		

Hall Environmental Analysis Laboratory, Inc.

Analytical Report

Lab Order 2305358

Date Reported: 5/15/2023

CLIENT: EA Engineering

Client Sample ID: 340-01

Project: Bright Star Dairy

Collection Date: 5/5/2023 3:05:00 PM

Lab ID: 2305358-003

Matrix: GROUNDWA

Received Date: 5/6/2023 11:00:00 AM

Analyses	Result	RL	Qual	Units	DF	Date Analyzed	Batch
EPA METHOD 300.0: ANIONS							Analyst: JMT
Chloride	610	50	*	mg/L	100	5/8/2023 5:38:35 PM	R96604
Sulfate	470	50	*	mg/L	100	5/8/2023 5:38:35 PM	R96604
Nitrate+Nitrite as N	62	2.0	*	mg/L	10	5/12/2023 2:06:47 PM	R96710
SM2540C MOD: TOTAL DISSOLVED SOLIDS							Analyst: RBC
Total Dissolved Solids	2870	100	*D	mg/L	1	5/10/2023 4:10:00 PM	74823
SM 4500 NORG C: TKN							Analyst: RBC
Nitrogen, Kjeldahl, Total	ND	1.0		mg/L	1	5/12/2023 2:36:00 PM	74922

Refer to the QC Summary report and sample login checklist for flagged QC data and preservation information.

Qualifiers:	*	Value exceeds Maximum Contaminant Level.	B	Analyte detected in the associated Method Blank
	D	Sample Diluted Due to Matrix	E	Above Quantitation Range/Estimated Value
	H	Holding times for preparation or analysis exceeded	J	Analyte detected below quantitation limits
	ND	Not Detected at the Reporting Limit	P	Sample pH Not In Range
	PQL	Practical Quantitative Limit	RL	Reporting Limit
	S	% Recovery outside of standard limits. If undiluted results may be estimated.		

QC SUMMARY REPORT

Hall Environmental Analysis Laboratory, Inc.

WO#: 2305358

15-May-23

Client: EA Engineering
Project: Bright Star Dairy

Sample ID: MB	SampType: mblk	TestCode: EPA Method 300.0: Anions								
Client ID: PBW	Batch ID: R96604	RunNo: 96604								
Prep Date:	Analysis Date: 5/8/2023	SeqNo: 3502772			Units: mg/L					
Analyte	Result	PQL	SPK value	SPK Ref Val	%REC	LowLimit	HighLimit	%RPD	RPDLimit	Qual
Chloride	ND	0.50								
Sulfate	ND	0.50								
Nitrate+Nitrite as N	ND	0.20								

Sample ID: LCS	SampType: lcs	TestCode: EPA Method 300.0: Anions								
Client ID: LCSW	Batch ID: R96604	RunNo: 96604								
Prep Date:	Analysis Date: 5/8/2023	SeqNo: 3502773			Units: mg/L					
Analyte	Result	PQL	SPK value	SPK Ref Val	%REC	LowLimit	HighLimit	%RPD	RPDLimit	Qual
Chloride	4.7	0.50	5.000	0	93.3	90	110			
Sulfate	9.5	0.50	10.00	0	94.9	90	110			
Nitrate+Nitrite as N	3.4	0.20	3.500	0	97.3	90	110			

Sample ID: MB	SampType: MBLK	TestCode: EPA Method 300.0: Anions								
Client ID: PBW	Batch ID: R96710	RunNo: 96710								
Prep Date:	Analysis Date: 5/12/2023	SeqNo: 3507957			Units: mg/L					
Analyte	Result	PQL	SPK value	SPK Ref Val	%REC	LowLimit	HighLimit	%RPD	RPDLimit	Qual
Chloride	ND	0.50								
Nitrate+Nitrite as N	ND	0.20								

Sample ID: LCS	SampType: LCS	TestCode: EPA Method 300.0: Anions								
Client ID: LCSW	Batch ID: R96710	RunNo: 96710								
Prep Date:	Analysis Date: 5/12/2023	SeqNo: 3507958			Units: mg/L					
Analyte	Result	PQL	SPK value	SPK Ref Val	%REC	LowLimit	HighLimit	%RPD	RPDLimit	Qual
Chloride	4.7	0.50	5.000	0	93.2	90	110			
Nitrate+Nitrite as N	3.4	0.20	3.500	0	97.7	90	110			

Qualifiers:

- * Value exceeds Maximum Contaminant Level.
- D Sample Diluted Due to Matrix
- H Holding times for preparation or analysis exceeded
- ND Not Detected at the Reporting Limit
- PQL Practical Quantitative Limit
- S % Recovery outside of standard limits. If undiluted results may be estimated.
- B Analyte detected in the associated Method Blank
- E Above Quantitation Range/Estimated Value
- J Analyte detected below quantitation limits
- P Sample pH Not In Range
- RL Reporting Limit

QC SUMMARY REPORT

Hall Environmental Analysis Laboratory, Inc.

WO#: 2305358

15-May-23

Client: EA Engineering
Project: Bright Star Dairy

Sample ID: MB-74823	SampType: MBLK	TestCode: SM2540C MOD: Total Dissolved Solids								
Client ID: PBW	Batch ID: 74823	RunNo: 96653								
Prep Date: 5/9/2023	Analysis Date: 5/10/2023	SeqNo: 3504703	Units: mg/L							
Analyte	Result	PQL	SPK value	SPK Ref Val	%REC	LowLimit	HighLimit	%RPD	RPDLimit	Qual
Total Dissolved Solids	ND	50.0								

Sample ID: LCS-74823	SampType: LCS	TestCode: SM2540C MOD: Total Dissolved Solids								
Client ID: LCSW	Batch ID: 74823	RunNo: 96653								
Prep Date: 5/9/2023	Analysis Date: 5/10/2023	SeqNo: 3504704	Units: mg/L							
Analyte	Result	PQL	SPK value	SPK Ref Val	%REC	LowLimit	HighLimit	%RPD	RPDLimit	Qual
Total Dissolved Solids	1010	50.0	1000	0	101	80	120			

Qualifiers:

- | | |
|---|---|
| * Value exceeds Maximum Contaminant Level. | B Analyte detected in the associated Method Blank |
| D Sample Diluted Due to Matrix | E Above Quantitation Range/Estimated Value |
| H Holding times for preparation or analysis exceeded | J Analyte detected below quantitation limits |
| ND Not Detected at the Reporting Limit | P Sample pH Not In Range |
| PQL Practical Quantitative Limit | RL Reporting Limit |
| S % Recovery outside of standard limits. If undiluted results may be estimated. | |

QC SUMMARY REPORT

Hall Environmental Analysis Laboratory, Inc.

WO#: 2305358

15-May-23

Client: EA Engineering
Project: Bright Star Dairy

Sample ID: MB-74922	SampType: MBLK	TestCode: SM 4500 Norg C: TKN								
Client ID: PBW	Batch ID: 74922	RunNo: 96727								
Prep Date: 5/12/2023	Analysis Date: 5/12/2023	SeqNo: 3507597	Units: mg/L							
Analyte	Result	PQL	SPK value	SPK Ref Val	%REC	LowLimit	HighLimit	%RPD	RPDLimit	Qual
Nitrogen, Kjeldahl, Total	ND	1.0								

Sample ID: LCS-74922	SampType: LCS	TestCode: SM 4500 Norg C: TKN								
Client ID: LCSW	Batch ID: 74922	RunNo: 96727								
Prep Date: 5/12/2023	Analysis Date: 5/12/2023	SeqNo: 3507598	Units: mg/L							
Analyte	Result	PQL	SPK value	SPK Ref Val	%REC	LowLimit	HighLimit	%RPD	RPDLimit	Qual
Nitrogen, Kjeldahl, Total	9.5	1.0	10.00	0	95.2	80	120			

Qualifiers:

- | | |
|---|---|
| * Value exceeds Maximum Contaminant Level. | B Analyte detected in the associated Method Blank |
| D Sample Diluted Due to Matrix | E Above Quantitation Range/Estimated Value |
| H Holding times for preparation or analysis exceeded | J Analyte detected below quantitation limits |
| ND Not Detected at the Reporting Limit | P Sample pH Not In Range |
| PQL Practical Quantitative Limit | RL Reporting Limit |
| S % Recovery outside of standard limits. If undiluted results may be estimated. | |



Sample Log-In Check List

Client Name: EA Engineering

Work Order Number: 2305358

RcptNo: 1

Received By: Cheyenne Cason 5/6/2023 11:00:00 AM

Handwritten signature

Completed By: Cheyenne Cason 5/6/2023 11:03:14 AM

Handwritten signature

Reviewed By: *WA* 5/8/23

Chain of Custody

1. Is Chain of Custody complete? Yes No Not Present
 2. How was the sample delivered? FedEx

Log In

3. Was an attempt made to cool the samples? Yes No NA
 4. Were all samples received at a temperature of >0° C to 6.0°C Yes No NA
 5. Sample(s) in proper container(s)? Yes No
 6. Sufficient sample volume for indicated test(s)? Yes No
 7. Are samples (except VOA and ONG) properly preserved? Yes No
 8. Was preservative added to bottles? Yes No NA
 9. Received at least 1 vial with headspace <1/4" for AQ VOA? Yes No NA
 10. Were any sample containers received broken? Yes No
 11. Does paperwork match bottle labels? Yes No
 (Note discrepancies on chain of custody)
 12. Are matrices correctly identified on Chain of Custody? Yes No
 13. Is it clear what analyses were requested? Yes No
 14. Were all holding times able to be met? Yes No
 (If no, notify customer for authorization.)

of preserved bottles checked for pH: 3
 (2 or >12 unless noted)
 Adjusted? NO
 Checked by: WA 5/8/23

Special Handling (if applicable)

15. Was client notified of all discrepancies with this order? Yes No NA

Person Notified:	<input type="text"/>	Date:	<input type="text"/>
By Whom:	<input type="text"/>	Via:	<input type="checkbox"/> eMail <input type="checkbox"/> Phone <input type="checkbox"/> Fax <input type="checkbox"/> In Person
Regarding:	<input type="text"/>		
Client Instructions:	<input type="text"/>		

16. Additional remarks:

17. Cooler Information

Cooler No	Temp °C	Condition	Seal Intact	Seal No	Seal Date	Signed By
1	0.3	Good	Not Present	Yogi		



Hall Environmental Analysis Laboratory
4901 Hawkins NE
Albuquerque, NM 87109
TEL: 505-345-3975 FAX: 505-345-4107
Website: www.hallenvironmental.com

May 18, 2023

Regina Mullen
EA Engineering
320 Gold Ave SW Suite 1210
Albuquerque, NM 87102
TEL:
FAX:

RE: Mountain View Dairy LLC

OrderNo.: 2305410

Dear Regina Mullen:

Hall Environmental Analysis Laboratory received 4 sample(s) on 5/9/2023 for the analyses presented in the following report.

These were analyzed according to EPA procedures or equivalent. To access our accredited tests please go to www.hallenvironmental.com or the state specific web sites. In order to properly interpret your results, it is imperative that you review this report in its entirety. See the sample checklist and/or the Chain of Custody for information regarding the sample receipt temperature and preservation. Data qualifiers or a narrative will be provided if the sample analysis or analytical quality control parameters require a flag. When necessary, data qualifiers are provided on both the sample analysis report and the QC summary report, both sections should be reviewed. All samples are reported, as received, unless otherwise indicated. Lab measurement of analytes considered field parameters that require analysis within 15 minutes of sampling such as pH and residual chlorine are qualified as being analyzed outside of the recommended holding time.

Please don't hesitate to contact HEAL for any additional information or clarifications.

ADHS Cert #AZ0682 -- NMED-DWB Cert #NM9425 -- NMED-Micro Cert #NM0901

Sincerely,

A handwritten signature in black ink, appearing to read 'Andy Freeman', is written in a cursive style.

Andy Freeman
Laboratory Manager
4901 Hawkins NE
Albuquerque, NM 87109

Hall Environmental Analysis Laboratory, Inc.

Analytical Report

Lab Order 2305410

Date Reported: 5/18/2023

CLIENT: EA Engineering

Client Sample ID: 70-03

Project: Mountain View Dairy LLC

Collection Date: 5/8/2023 10:55:00 AM

Lab ID: 2305410-001

Matrix: GROUNDWA

Received Date: 5/9/2023 8:50:00 AM

Analyses	Result	RL	Qual	Units	DF	Date Analyzed	Batch
EPA METHOD 300.0: ANIONS							Analyst: JMT
Chloride	1500	100	*	mg/L	200	5/13/2023 2:56:36 PM	R96741
Nitrogen, Nitrite (As N)	ND	1.0		mg/L	10	5/9/2023 6:58:08 PM	R96634
Nitrogen, Nitrate (As N)	39	1.0	*	mg/L	10	5/9/2023 6:58:08 PM	R96634
Sulfate	1000	50	*	mg/L	100	5/9/2023 7:10:28 PM	R96634
SM2540C MOD: TOTAL DISSOLVED SOLIDS							Analyst: RBC
Total Dissolved Solids	4640	250	*D	mg/L	1	5/11/2023 2:32:00 PM	74851
SM 4500 NORG C: TKN							Analyst: DML
Nitrogen, Kjeldahl, Total	ND	5.0	D	mg/L	1	5/16/2023 9:34:00 AM	74956

Refer to the QC Summary report and sample login checklist for flagged QC data and preservation information.

Qualifiers:	*	Value exceeds Maximum Contaminant Level.	B	Analyte detected in the associated Method Blank
	D	Sample Diluted Due to Matrix	E	Above Quantitation Range/Estimated Value
	H	Holding times for preparation or analysis exceeded	J	Analyte detected below quantitation limits
	ND	Not Detected at the Reporting Limit	P	Sample pH Not In Range
	PQL	Practical Quantitative Limit	RL	Reporting Limit
	S	% Recovery outside of standard limits. If undiluted results may be estimated.		

Hall Environmental Analysis Laboratory, Inc.

Analytical Report

Lab Order 2305410

Date Reported: 5/18/2023

CLIENT: EA Engineering

Client Sample ID: 70-01

Project: Mountain View Dairy LLC

Collection Date: 5/8/2023 12:20:00 PM

Lab ID: 2305410-002

Matrix: GROUNDWA

Received Date: 5/9/2023 8:50:00 AM

Analyses	Result	RL	Qual	Units	DF	Date Analyzed	Batch
EPA METHOD 300.0: ANIONS							Analyst: JMT
Chloride	770	50	*	mg/L	100	5/9/2023 7:59:51 PM	R96634
Nitrogen, Nitrite (As N)	ND	1.0		mg/L	10	5/9/2023 7:47:30 PM	R96634
Nitrogen, Nitrate (As N)	13	1.0	*	mg/L	10	5/9/2023 7:47:30 PM	R96634
Sulfate	890	50	*	mg/L	100	5/9/2023 7:59:51 PM	R96634
SM2540C MOD: TOTAL DISSOLVED SOLIDS							Analyst: RBC
Total Dissolved Solids	3100	100	*D	mg/L	1	5/11/2023 2:32:00 PM	74851
SM 4500 NORG C: TKN							Analyst: DML
Nitrogen, Kjeldahl, Total	ND	2.0	D	mg/L	1	5/16/2023 9:34:00 AM	74956

Refer to the QC Summary report and sample login checklist for flagged QC data and preservation information.

Qualifiers:	*	Value exceeds Maximum Contaminant Level.	B	Analyte detected in the associated Method Blank
	D	Sample Diluted Due to Matrix	E	Above Quantitation Range/Estimated Value
	H	Holding times for preparation or analysis exceeded	J	Analyte detected below quantitation limits
	ND	Not Detected at the Reporting Limit	P	Sample pH Not In Range
	PQL	Practical Quantitative Limit	RL	Reporting Limit
	S	% Recovery outside of standard limits. If undiluted results may be estimated.		

Hall Environmental Analysis Laboratory, Inc.

Analytical Report

Lab Order 2305410

Date Reported: 5/18/2023

CLIENT: EA Engineering

Client Sample ID: 70-02

Project: Mountain View Dairy LLC

Collection Date: 5/8/2023 2:10:00 PM

Lab ID: 2305410-003

Matrix: GROUNDWA

Received Date: 5/9/2023 8:50:00 AM

Analyses	Result	RL	Qual	Units	DF	Date Analyzed	Batch
EPA METHOD 300.0: ANIONS							Analyst: JMT
Chloride	740	50	*	mg/L	100	5/9/2023 8:24:32 PM	R96634
Nitrogen, Nitrite (As N)	ND	1.0		mg/L	10	5/9/2023 8:12:11 PM	R96634
Nitrogen, Nitrate (As N)	29	1.0	*	mg/L	10	5/9/2023 8:12:11 PM	R96634
Sulfate	510	50	*	mg/L	100	5/9/2023 8:24:32 PM	R96634
SM2540C MOD: TOTAL DISSOLVED SOLIDS							Analyst: RBC
Total Dissolved Solids	2890	100	*D	mg/L	1	5/11/2023 2:32:00 PM	74851
SM 4500 NORG C: TKN							Analyst: DML
Nitrogen, Kjeldahl, Total	ND	5.0	D	mg/L	1	5/16/2023 9:34:00 AM	74956

Refer to the QC Summary report and sample login checklist for flagged QC data and preservation information.

Qualifiers:	*	Value exceeds Maximum Contaminant Level.	B	Analyte detected in the associated Method Blank
	D	Sample Diluted Due to Matrix	E	Above Quantitation Range/Estimated Value
	H	Holding times for preparation or analysis exceeded	J	Analyte detected below quantitation limits
	ND	Not Detected at the Reporting Limit	P	Sample pH Not In Range
	PQL	Practical Quantitative Limit	RL	Reporting Limit
	S	% Recovery outside of standard limits. If undiluted results may be estimated.		

Hall Environmental Analysis Laboratory, Inc.

Analytical Report

Lab Order 2305410

Date Reported: 5/18/2023

CLIENT: EA Engineering

Client Sample ID: 70-04

Project: Mountain View Dairy LLC

Collection Date: 5/8/2023 3:20:00 PM

Lab ID: 2305410-004

Matrix: GROUNDWA

Received Date: 5/9/2023 8:50:00 AM

Analyses	Result	RL	Qual	Units	DF	Date Analyzed	Batch
EPA METHOD 300.0: ANIONS							Analyst: JMT
Chloride	700	50	*	mg/L	100	5/9/2023 8:49:13 PM	R96634
Nitrogen, Nitrite (As N)	ND	1.0		mg/L	10	5/9/2023 8:36:53 PM	R96634
Nitrogen, Nitrate (As N)	22	1.0	*	mg/L	10	5/9/2023 8:36:53 PM	R96634
Sulfate	770	50	*	mg/L	100	5/9/2023 8:49:13 PM	R96634
SM2540C MOD: TOTAL DISSOLVED SOLIDS							Analyst: RBC
Total Dissolved Solids	3020	100	*D	mg/L	1	5/11/2023 2:32:00 PM	74851
SM 4500 NORG C: TKN							Analyst: DML
Nitrogen, Kjeldahl, Total	ND	5.0	D	mg/L	1	5/16/2023 9:34:00 AM	74956

Refer to the QC Summary report and sample login checklist for flagged QC data and preservation information.

Qualifiers:	*	Value exceeds Maximum Contaminant Level.	B	Analyte detected in the associated Method Blank
	D	Sample Diluted Due to Matrix	E	Above Quantitation Range/Estimated Value
	H	Holding times for preparation or analysis exceeded	J	Analyte detected below quantitation limits
	ND	Not Detected at the Reporting Limit	P	Sample pH Not In Range
	PQL	Practical Quantitative Limit	RL	Reporting Limit
	S	% Recovery outside of standard limits. If undiluted results may be estimated.		

QC SUMMARY REPORT

Hall Environmental Analysis Laboratory, Inc.

WO#: 2305410

18-May-23

Client: EA Engineering
Project: Mountain View Dairy LLC

Sample ID: MB	SampType: mblk	TestCode: EPA Method 300.0: Anions								
Client ID: PBW	Batch ID: R96634	RunNo: 96634								
Prep Date:	Analysis Date: 5/9/2023	SeqNo: 3503991	Units: mg/L							
Analyte	Result	PQL	SPK value	SPK Ref Val	%REC	LowLimit	HighLimit	%RPD	RPDLimit	Qual

Chloride	ND	0.50								
Nitrogen, Nitrite (As N)	ND	0.10								
Nitrogen, Nitrate (As N)	ND	0.10								
Sulfate	ND	0.50								

Sample ID: LCS	SampType: ics	TestCode: EPA Method 300.0: Anions								
Client ID: LCSW	Batch ID: R96634	RunNo: 96634								
Prep Date:	Analysis Date: 5/9/2023	SeqNo: 3503992	Units: mg/L							
Analyte	Result	PQL	SPK value	SPK Ref Val	%REC	LowLimit	HighLimit	%RPD	RPDLimit	Qual

Chloride	4.6	0.50	5.000	0	92.7	90	110			
Nitrogen, Nitrite (As N)	0.94	0.10	1.000	0	93.9	90	110			
Nitrogen, Nitrate (As N)	2.4	0.10	2.500	0	97.9	90	110			
Sulfate	9.6	0.50	10.00	0	95.9	90	110			

Sample ID: MB	SampType: mblk	TestCode: EPA Method 300.0: Anions								
Client ID: PBW	Batch ID: R96741	RunNo: 96741								
Prep Date:	Analysis Date: 5/13/2023	SeqNo: 3508132	Units: mg/L							
Analyte	Result	PQL	SPK value	SPK Ref Val	%REC	LowLimit	HighLimit	%RPD	RPDLimit	Qual

Chloride	ND	0.50								
----------	----	------	--	--	--	--	--	--	--	--

Sample ID: LCS	SampType: ics	TestCode: EPA Method 300.0: Anions								
Client ID: LCSW	Batch ID: R96741	RunNo: 96741								
Prep Date:	Analysis Date: 5/13/2023	SeqNo: 3508133	Units: mg/L							
Analyte	Result	PQL	SPK value	SPK Ref Val	%REC	LowLimit	HighLimit	%RPD	RPDLimit	Qual

Chloride	4.7	0.50	5.000	0	94.0	90	110			
----------	-----	------	-------	---	------	----	-----	--	--	--

Qualifiers:

- | | |
|---|---|
| * Value exceeds Maximum Contaminant Level. | B Analyte detected in the associated Method Blank |
| D Sample Diluted Due to Matrix | E Above Quantitation Range/Estimated Value |
| H Holding times for preparation or analysis exceeded | J Analyte detected below quantitation limits |
| ND Not Detected at the Reporting Limit | P Sample pH Not In Range |
| PQL Practical Quantitative Limit | RL Reporting Limit |
| S % Recovery outside of standard limits. If undiluted results may be estimated. | |

QC SUMMARY REPORT

Hall Environmental Analysis Laboratory, Inc.

WO#: 2305410

18-May-23

Client: EA Engineering
Project: Mountain View Dairy LLC

Sample ID: MB-74851	SampType: MBLK	TestCode: SM2540C MOD: Total Dissolved Solids								
Client ID: PBW	Batch ID: 74851	RunNo: 96686								
Prep Date: 5/10/2023	Analysis Date: 5/11/2023	SeqNo: 3505957	Units: mg/L							
Analyte	Result	PQL	SPK value	SPK Ref Val	%REC	LowLimit	HighLimit	%RPD	RPDLimit	Qual
Total Dissolved Solids	ND	50.0								

Sample ID: LCS-74851	SampType: LCS	TestCode: SM2540C MOD: Total Dissolved Solids								
Client ID: LCSW	Batch ID: 74851	RunNo: 96686								
Prep Date: 5/10/2023	Analysis Date: 5/11/2023	SeqNo: 3505958	Units: mg/L							
Analyte	Result	PQL	SPK value	SPK Ref Val	%REC	LowLimit	HighLimit	%RPD	RPDLimit	Qual
Total Dissolved Solids	987	50.0	1000	0	98.7	80	120			

Qualifiers:

- * Value exceeds Maximum Contaminant Level.
- D Sample Diluted Due to Matrix
- H Holding times for preparation or analysis exceeded
- ND Not Detected at the Reporting Limit
- PQL Practical Quantitative Limit
- S % Recovery outside of standard limits. If undiluted results may be estimated.
- B Analyte detected in the associated Method Blank
- E Above Quantitation Range/Estimated Value
- J Analyte detected below quantitation limits
- P Sample pH Not In Range
- RL Reporting Limit

QC SUMMARY REPORT

Hall Environmental Analysis Laboratory, Inc.

WO#: 2305410

18-May-23

Client: EA Engineering
Project: Mountain View Dairy LLC

Sample ID: MB-74956	SampType: MBLK	TestCode: SM 4500 Norg C: TKN								
Client ID: PBW	Batch ID: 74956	RunNo: 96781								
Prep Date: 5/15/2023	Analysis Date: 5/16/2023	SeqNo: 3510082	Units: mg/L							
Analyte	Result	PQL	SPK value	SPK Ref Val	%REC	LowLimit	HighLimit	%RPD	RPDLimit	Qual
Nitrogen, Kjeldahl, Total	ND	1.0								

Sample ID: LCS-74956	SampType: LCS	TestCode: SM 4500 Norg C: TKN								
Client ID: LCSW	Batch ID: 74956	RunNo: 96781								
Prep Date: 5/15/2023	Analysis Date: 5/16/2023	SeqNo: 3510083	Units: mg/L							
Analyte	Result	PQL	SPK value	SPK Ref Val	%REC	LowLimit	HighLimit	%RPD	RPDLimit	Qual
Nitrogen, Kjeldahl, Total	10	1.0	10.00	0	101	80	120			

Qualifiers:

- | | |
|---|---|
| * Value exceeds Maximum Contaminant Level. | B Analyte detected in the associated Method Blank |
| D Sample Diluted Due to Matrix | E Above Quantitation Range/Estimated Value |
| H Holding times for preparation or analysis exceeded | J Analyte detected below quantitation limits |
| ND Not Detected at the Reporting Limit | P Sample pH Not In Range |
| PQL Practical Quantitative Limit | RL Reporting Limit |
| S % Recovery outside of standard limits. If undiluted results may be estimated. | |



Sample Log-In Check List

Client Name: EA Engineering

Work Order Number: 2305410

RcptNo: 1

Received By: Tracy Casarrubias 5/9/2023 8:50:00 AM

Completed By: Tracy Casarrubias 5/9/2023 9:21:29 AM

Reviewed By: *WB 5/9/23*

Chain of Custody

1. Is Chain of Custody complete? Yes No Not Present
2. How was the sample delivered? FedEx

Log In

3. Was an attempt made to cool the samples? Yes No NA
4. Were all samples received at a temperature of >0° C to 6.0°C Yes No NA
5. Sample(s) in proper container(s)? Yes No
6. Sufficient sample volume for indicated test(s)? Yes No
7. Are samples (except VOA and ONG) properly preserved? Yes No
8. Was preservative added to bottles? Yes No NA
9. Received at least 1 vial with headspace <1/4" for AQ VOA? Yes No NA
10. Were any sample containers received broken? Yes No
11. Does paperwork match bottle labels? Yes No
 (Note discrepancies on chain of custody)
12. Are matrices correctly identified on Chain of Custody? Yes No
13. Is it clear what analyses were requested? Yes No
14. Were all holding times able to be met? Yes No
 (If no, notify customer for authorization.)

of preserved bottles checked for pH: 4
 (<2 or >12 unless noted)
 Adjusted? NO
 Checked by: WB 5/9/23

Special Handling (if applicable)

15. Was client notified of all discrepancies with this order? Yes No NA

Person Notified:	<input type="text"/>	Date:	<input type="text"/>
By Whom:	<input type="text"/>	Via:	<input type="checkbox"/> eMail <input type="checkbox"/> Phone <input type="checkbox"/> Fax <input type="checkbox"/> In Person
Regarding:	<input type="text"/>		
Client Instructions:	<input type="text"/>		

16. Additional remarks:

17. Cooler Information

Cooler No	Temp °C	Condition	Seal Intact	Seal No	Seal Date	Signed By
1	0.8	Good	Not Present	Morty		



Hall Environmental Analysis Laboratory
4901 Hawkins NE
Albuquerque, NM 87109
TEL: 505-345-3975 FAX: 505-345-4107
Website: www.hallenvironmental.com

May 18, 2023

Regina Mullen
EA Engineering
320 Gold Ave SW Suite 1210
Albuquerque, NM 87102
TEL:
FAX:

RE: Dominguez Dairy 2

OrderNo.: 2305509

Dear Regina Mullen:

Hall Environmental Analysis Laboratory received 3 sample(s) on 5/10/2023 for the analyses presented in the following report.

These were analyzed according to EPA procedures or equivalent. To access our accredited tests please go to www.hallenvironmental.com or the state specific web sites. In order to properly interpret your results, it is imperative that you review this report in its entirety. See the sample checklist and/or the Chain of Custody for information regarding the sample receipt temperature and preservation. Data qualifiers or a narrative will be provided if the sample analysis or analytical quality control parameters require a flag. When necessary, data qualifiers are provided on both the sample analysis report and the QC summary report, both sections should be reviewed. All samples are reported, as received, unless otherwise indicated. Lab measurement of analytes considered field parameters that require analysis within 15 minutes of sampling such as pH and residual chlorine are qualified as being analyzed outside of the recommended holding time.

Please don't hesitate to contact HEAL for any additional information or clarifications.

ADHS Cert #AZ0682 -- NMED-DWB Cert #NM9425 -- NMED-Micro Cert #NM0901

Sincerely,

A handwritten signature in black ink, appearing to read 'Andy Freeman', is written in a cursive style.

Andy Freeman
Laboratory Manager
4901 Hawkins NE
Albuquerque, NM 87109

Hall Environmental Analysis Laboratory, Inc.

Analytical Report

Lab Order 2305509

Date Reported: 5/18/2023

CLIENT: EA Engineering

Client Sample ID: 42-03

Project: Dominguez Dairy 2

Collection Date: 5/9/2023 10:19:00 AM

Lab ID: 2305509-001

Matrix: GROUNDWA

Received Date: 5/10/2023 9:05:00 AM

Analyses	Result	RL	Qual	Units	DF	Date Analyzed	Batch
EPA METHOD 300.0: ANIONS							Analyst: JMT
Chloride	1200	50	*	mg/L	100	5/10/2023 5:29:20 PM	R96674
Nitrogen, Nitrite (As N)	ND	1.0		mg/L	10	5/10/2023 5:16:28 PM	R96674
Nitrogen, Nitrate (As N)	34	1.0	*	mg/L	10	5/10/2023 5:16:28 PM	R96674
SM2540C MOD: TOTAL DISSOLVED SOLIDS							Analyst: RBC
Total Dissolved Solids	3160	100	*D	mg/L	1	5/12/2023 4:16:00 PM	74887
SM 4500 NORG C: TKN							Analyst: DML
Nitrogen, Kjeldahl, Total	ND	5.0	D	mg/L	1	5/18/2023 10:10:00 AM	74982

Refer to the QC Summary report and sample login checklist for flagged QC data and preservation information.

Qualifiers:	*	Value exceeds Maximum Contaminant Level.	B	Analyte detected in the associated Method Blank
	D	Sample Diluted Due to Matrix	E	Above Quantitation Range/Estimated Value
	H	Holding times for preparation or analysis exceeded	J	Analyte detected below quantitation limits
	ND	Not Detected at the Reporting Limit	P	Sample pH Not In Range
	PQL	Practical Quantitative Limit	RL	Reporting Limit
	S	% Recovery outside of standard limits. If undiluted results may be estimated.		

Hall Environmental Analysis Laboratory, Inc.

Analytical Report

Lab Order 2305509

Date Reported: 5/18/2023

CLIENT: EA Engineering

Client Sample ID: 42-13

Project: Dominguez Dairy 2

Collection Date: 5/9/2023 12:25:00 PM

Lab ID: 2305509-002

Matrix: GROUNDWA

Received Date: 5/10/2023 9:05:00 AM

Analyses	Result	RL	Qual	Units	DF	Date Analyzed	Batch
EPA METHOD 300.0: ANIONS							Analyst: JMT
Chloride	900	50	*	mg/L	100	5/10/2023 6:20:46 PM	R96674
Nitrogen, Nitrite (As N)	ND	1.0		mg/L	10	5/10/2023 6:07:54 PM	R96674
Nitrogen, Nitrate (As N)	11	1.0	*	mg/L	10	5/10/2023 6:07:54 PM	R96674
SM2540C MOD: TOTAL DISSOLVED SOLIDS							Analyst: RBC
Total Dissolved Solids	3060	100	*D	mg/L	1	5/12/2023 4:16:00 PM	74887
SM 4500 NORG C: TKN							Analyst: DML
Nitrogen, Kjeldahl, Total	ND	2.0	D	mg/L	1	5/18/2023 10:10:00 AM	74982

Refer to the QC Summary report and sample login checklist for flagged QC data and preservation information.

Qualifiers:	*	Value exceeds Maximum Contaminant Level.	B	Analyte detected in the associated Method Blank
	D	Sample Diluted Due to Matrix	E	Above Quantitation Range/Estimated Value
	H	Holding times for preparation or analysis exceeded	J	Analyte detected below quantitation limits
	ND	Not Detected at the Reporting Limit	P	Sample pH Not In Range
	PQL	Practical Quantitative Limit	RL	Reporting Limit
	S	% Recovery outside of standard limits. If undiluted results may be estimated.		

Hall Environmental Analysis Laboratory, Inc.

Analytical Report

Lab Order 2305509

Date Reported: 5/18/2023

CLIENT: EA Engineering

Client Sample ID: 42-06

Project: Dominguez Dairy 2

Collection Date: 5/9/2023 2:35:00 PM

Lab ID: 2305509-003

Matrix: GROUNDWA

Received Date: 5/10/2023 9:05:00 AM

Analyses	Result	RL	Qual	Units	DF	Date Analyzed	Batch
EPA METHOD 300.0: ANIONS							Analyst: JMT
Chloride	370	50	*	mg/L	100	5/10/2023 6:46:31 PM	R96674
Nitrogen, Nitrite (As N)	ND	1.0		mg/L	10	5/10/2023 6:33:38 PM	R96674
Nitrogen, Nitrate (As N)	91	10	*	mg/L	100	5/10/2023 6:46:31 PM	R96674
SM2540C MOD: TOTAL DISSOLVED SOLIDS							Analyst: RBC
Total Dissolved Solids	2530	100	*D	mg/L	1	5/12/2023 4:16:00 PM	74887
SM 4500 NORG C: TKN							Analyst: DML
Nitrogen, Kjeldahl, Total	ND	5.0	D	mg/L	1	5/18/2023 10:10:00 AM	74982

Refer to the QC Summary report and sample login checklist for flagged QC data and preservation information.

Qualifiers:	*	Value exceeds Maximum Contaminant Level.	B	Analyte detected in the associated Method Blank
	D	Sample Diluted Due to Matrix	E	Above Quantitation Range/Estimated Value
	H	Holding times for preparation or analysis exceeded	J	Analyte detected below quantitation limits
	ND	Not Detected at the Reporting Limit	P	Sample pH Not In Range
	PQL	Practical Quantitative Limit	RL	Reporting Limit
	S	% Recovery outside of standard limits. If undiluted results may be estimated.		

QC SUMMARY REPORT

Hall Environmental Analysis Laboratory, Inc.

WO#: 2305509

18-May-23

Client: EA Engineering
Project: Dominguez Dairy 2

Sample ID: MB	SampType: mblk	TestCode: EPA Method 300.0: Anions								
Client ID: PBW	Batch ID: R96674	RunNo: 96674								
Prep Date:	Analysis Date: 5/10/2023	SeqNo: 3505326	Units: mg/L							
Analyte	Result	PQL	SPK value	SPK Ref Val	%REC	LowLimit	HighLimit	%RPD	RPDLimit	Qual
Chloride	ND	0.50								
Nitrogen, Nitrite (As N)	ND	0.10								
Nitrogen, Nitrate (As N)	ND	0.10								

Sample ID: LCS	SampType: ics	TestCode: EPA Method 300.0: Anions								
Client ID: LCSW	Batch ID: R96674	RunNo: 96674								
Prep Date:	Analysis Date: 5/10/2023	SeqNo: 3505327	Units: mg/L							
Analyte	Result	PQL	SPK value	SPK Ref Val	%REC	LowLimit	HighLimit	%RPD	RPDLimit	Qual
Chloride	4.7	0.50	5.000	0	94.4	90	110			
Nitrogen, Nitrite (As N)	0.97	0.10	1.000	0	97.2	90	110			
Nitrogen, Nitrate (As N)	2.5	0.10	2.500	0	101	90	110			

Qualifiers:

- * Value exceeds Maximum Contaminant Level.
- D Sample Diluted Due to Matrix
- H Holding times for preparation or analysis exceeded
- ND Not Detected at the Reporting Limit
- PQL Practical Quantitative Limit
- S % Recovery outside of standard limits. If undiluted results may be estimated.
- B Analyte detected in the associated Method Blank
- E Above Quantitation Range/Estimated Value
- J Analyte detected below quantitation limits
- P Sample pH Not In Range
- RL Reporting Limit

QC SUMMARY REPORT

Hall Environmental Analysis Laboratory, Inc.

WO#: 2305509

18-May-23

Client: EA Engineering
Project: Dominguez Dairy 2

Sample ID: MB-74887	SampType: MBLK	TestCode: SM2540C MOD: Total Dissolved Solids								
Client ID: PBW	Batch ID: 74887	RunNo: 96726								
Prep Date: 5/11/2023	Analysis Date: 5/12/2023	SeqNo: 3507573	Units: mg/L							
Analyte	Result	PQL	SPK value	SPK Ref Val	%REC	LowLimit	HighLimit	%RPD	RPDLimit	Qual
Total Dissolved Solids	ND	50.0								

Sample ID: LCS-74887	SampType: LCS	TestCode: SM2540C MOD: Total Dissolved Solids								
Client ID: LCSW	Batch ID: 74887	RunNo: 96726								
Prep Date: 5/11/2023	Analysis Date: 5/12/2023	SeqNo: 3507574	Units: mg/L							
Analyte	Result	PQL	SPK value	SPK Ref Val	%REC	LowLimit	HighLimit	%RPD	RPDLimit	Qual
Total Dissolved Solids	985	50.0	1000	0	98.5	80	120			

Qualifiers:

- * Value exceeds Maximum Contaminant Level.
- D Sample Diluted Due to Matrix
- H Holding times for preparation or analysis exceeded
- ND Not Detected at the Reporting Limit
- PQL Practical Quantitative Limit
- S % Recovery outside of standard limits. If undiluted results may be estimated.
- B Analyte detected in the associated Method Blank
- E Above Quantitation Range/Estimated Value
- J Analyte detected below quantitation limits
- P Sample pH Not In Range
- RL Reporting Limit

QC SUMMARY REPORT

Hall Environmental Analysis Laboratory, Inc.

WO#: 2305509

18-May-23

Client: EA Engineering
Project: Dominguez Dairy 2

Sample ID: MB-74982	SampType: MBLK	TestCode: SM 4500 Norg C: TKN								
Client ID: PBW	Batch ID: 74982	RunNo: 96845								
Prep Date: 5/16/2023	Analysis Date: 5/18/2023	SeqNo: 3513044	Units: mg/L							
Analyte	Result	PQL	SPK value	SPK Ref Val	%REC	LowLimit	HighLimit	%RPD	RPDLimit	Qual
Nitrogen, Kjeldahl, Total	ND	1.0								

Sample ID: LCS-74982	SampType: LCS	TestCode: SM 4500 Norg C: TKN								
Client ID: LCSW	Batch ID: 74982	RunNo: 96845								
Prep Date: 5/16/2023	Analysis Date: 5/18/2023	SeqNo: 3513045	Units: mg/L							
Analyte	Result	PQL	SPK value	SPK Ref Val	%REC	LowLimit	HighLimit	%RPD	RPDLimit	Qual
Nitrogen, Kjeldahl, Total	10	1.0	10.00	0	101	80	120			

Qualifiers:

- | | |
|---|---|
| * Value exceeds Maximum Contaminant Level. | B Analyte detected in the associated Method Blank |
| D Sample Diluted Due to Matrix | E Above Quantitation Range/Estimated Value |
| H Holding times for preparation or analysis exceeded | J Analyte detected below quantitation limits |
| ND Not Detected at the Reporting Limit | P Sample pH Not In Range |
| PQL Practical Quantitative Limit | RL Reporting Limit |
| S % Recovery outside of standard limits. If undiluted results may be estimated. | |

Sample Log-In Check List

Client Name: EA Engineering

Work Order Number: 2305509

RcptNo: 1

Received By: Desiree Dominguez 5/10/2023 9:05:00 AM *DD*

Completed By: Desiree Dominguez 5/10/2023 9:40:41 AM *DD*

Reviewed By: *JH 5-10-23*

Chain of Custody

1. Is Chain of Custody complete? Yes No Not Present

2. How was the sample delivered? FedEx

Log In

3. Was an attempt made to cool the samples? Yes No NA

4. Were all samples received at a temperature of >0° C to 6.0°C Yes No NA

5. Sample(s) in proper container(s)? Yes No

6. Sufficient sample volume for indicated test(s)? Yes No

7. Are samples (except VOA and ONG) properly preserved? Yes No

8. Was preservative added to bottles? Yes No NA

9. Received at least 1 vial with headspace <1/4" for AQ VOA? Yes No NA

10. Were any sample containers received broken? Yes No

11. Does paperwork match bottle labels? Yes No
 (Note discrepancies on chain of custody)

12. Are matrices correctly identified on Chain of Custody? Yes No

13. Is it clear what analyses were requested? Yes No

14. Were all holding times able to be met? Yes No
 (If no, notify customer for authorization.)

of preserved bottles checked for pH: 3
 (<2 or >12 unless noted)
 Adjusted? No
 Checked by: JH 5/10/23

Special Handling (if applicable)

15. Was client notified of all discrepancies with this order? Yes No NA

Person Notified:	<input type="text"/>	Date:	<input type="text"/>
By Whom:	<input type="text"/>	Via:	<input type="checkbox"/> eMail <input type="checkbox"/> Phone <input type="checkbox"/> Fax <input type="checkbox"/> In Person
Regarding:	<input type="text"/>		
Client Instructions:	<input type="text"/>		

16. Additional remarks:

17. Cooler Information

Cooler No	Temp °C	Condition	Seal Intact	Seal No	Seal Date	Signed By
1	0.2	Good	Not Present	Morty		

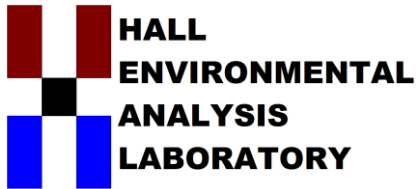

Hall Environmental Analysis Laboratory
4901 Hawkins NE
Albuquerque, NM 87109
TEL: 505-345-3975 FAX: 505-345-4107
Website: www.hallenvironmental.com

May 19, 2023

Regina Mullen
EA Engineering
320 Gold Ave SW Suite 1210
Albuquerque, NM 87102
TEL:
FAX

RE: Dominguez Dairy 2

OrderNo.: 2305597

Dear Regina Mullen:

Hall Environmental Analysis Laboratory received 3 sample(s) on 5/11/2023 for the analyses presented in the following report.

These were analyzed according to EPA procedures or equivalent. To access our accredited tests please go to www.hallenvironmental.com or the state specific web sites. In order to properly interpret your results, it is imperative that you review this report in its entirety. See the sample checklist and/or the Chain of Custody for information regarding the sample receipt temperature and preservation. Data qualifiers or a narrative will be provided if the sample analysis or analytical quality control parameters require a flag. When necessary, data qualifiers are provided on both the sample analysis report and the QC summary report, both sections should be reviewed. All samples are reported, as received, unless otherwise indicated. Lab measurement of analytes considered field parameters that require analysis within 15 minutes of sampling such as pH and residual chlorine are qualified as being analyzed outside of the recommended holding time.

Please don't hesitate to contact HEAL for any additional information or clarifications.

ADHS Cert #AZ0682 -- NMED-DWB Cert #NM9425 -- NMED-Micro Cert #NM0901

Sincerely,

A handwritten signature in black ink, appearing to read 'Andy Freeman', is written over a light blue horizontal line.

Andy Freeman
Laboratory Manager
4901 Hawkins NE
Albuquerque, NM 87109

Hall Environmental Analysis Laboratory, Inc.

Analytical Report

Lab Order 2305597

Date Reported: 5/19/2023

CLIENT: EA Engineering

Client Sample ID: 42-02

Project: Dominguez Dairy 2

Collection Date: 5/10/2023 11:30:00 AM

Lab ID: 2305597-001

Matrix: GROUNDWA

Received Date: 5/11/2023 8:50:00 AM

Analyses	Result	RL	Qual	Units	DF	Date Analyzed	Batch
EPA METHOD 300.0: ANIONS							Analyst: NAI
Chloride	610	50	*	mg/L	100	5/11/2023 2:42:25 PM	R96705
Nitrogen, Nitrite (As N)	ND	1.0		mg/L	10	5/11/2023 2:29:33 PM	R96705
Nitrogen, Nitrate (As N)	8.8	1.0		mg/L	10	5/11/2023 2:29:33 PM	R96705
SM2540C MOD: TOTAL DISSOLVED SOLIDS							Analyst: RBC
Total Dissolved Solids	2710	50.0	*	mg/L	1	5/16/2023 8:30:00 AM	74912
SM 4500 NORG C: TKN							Analyst: DML
Nitrogen, Kjeldahl, Total	ND	1.0		mg/L	1	5/17/2023 2:45:00 PM	74981

Refer to the QC Summary report and sample login checklist for flagged QC data and preservation information.

Qualifiers:	*	Value exceeds Maximum Contaminant Level.	B	Analyte detected in the associated Method Blank
	D	Sample Diluted Due to Matrix	E	Above Quantitation Range/Estimated Value
	H	Holding times for preparation or analysis exceeded	J	Analyte detected below quantitation limits
	ND	Not Detected at the Reporting Limit	P	Sample pH Not In Range
	PQL	Practical Quantitative Limit	RL	Reporting Limit
	S	% Recovery outside of standard limits. If undiluted results may be estimated.		

Hall Environmental Analysis Laboratory, Inc.

Analytical Report

Lab Order 2305597

Date Reported: 5/19/2023

CLIENT: EA Engineering

Client Sample ID: 42-08

Project: Dominguez Dairy 2

Collection Date: 5/10/2023 1:26:00 PM

Lab ID: 2305597-002

Matrix: GROUNDWA

Received Date: 5/11/2023 8:50:00 AM

Analyses	Result	RL	Qual	Units	DF	Date Analyzed	Batch
EPA METHOD 300.0: ANIONS							Analyst: NAI
Chloride	530	50	*	mg/L	100	5/11/2023 3:08:09 PM	R96705
Nitrogen, Nitrite (As N)	ND	1.0		mg/L	10	5/11/2023 2:55:17 PM	R96705
Nitrogen, Nitrate (As N)	11	1.0	*	mg/L	10	5/11/2023 2:55:17 PM	R96705
SM2540C MOD: TOTAL DISSOLVED SOLIDS							Analyst: RBC
Total Dissolved Solids	2600	100	*D	mg/L	1	5/16/2023 8:30:00 AM	74912
SM 4500 NORG C: TKN							Analyst: DML
Nitrogen, Kjeldahl, Total	ND	2.0	D	mg/L	1	5/17/2023 2:45:00 PM	74981

Refer to the QC Summary report and sample login checklist for flagged QC data and preservation information.

Qualifiers:	*	Value exceeds Maximum Contaminant Level.	B	Analyte detected in the associated Method Blank
	D	Sample Diluted Due to Matrix	E	Above Quantitation Range/Estimated Value
	H	Holding times for preparation or analysis exceeded	J	Analyte detected below quantitation limits
	ND	Not Detected at the Reporting Limit	P	Sample pH Not In Range
	PQL	Practical Quantitative Limit	RL	Reporting Limit
	S	% Recovery outside of standard limits. If undiluted results may be estimated.		

Hall Environmental Analysis Laboratory, Inc.

Analytical Report

Lab Order 2305597

Date Reported: 5/19/2023

CLIENT: EA Engineering

Client Sample ID: 42-11

Project: Dominguez Dairy 2

Collection Date: 5/10/2023 3:42:00 PM

Lab ID: 2305597-003

Matrix: GROUNDWA

Received Date: 5/11/2023 8:50:00 AM

Analyses	Result	RL	Qual	Units	DF	Date Analyzed	Batch
EPA METHOD 300.0: ANIONS							Analyst: NAI
Chloride	440	50	*	mg/L	100	5/11/2023 3:33:52 PM	R96705
Nitrogen, Nitrite (As N)	ND	1.0		mg/L	10	5/11/2023 3:21:01 PM	R96705
Nitrogen, Nitrate (As N)	ND	1.0		mg/L	10	5/11/2023 3:21:01 PM	R96705
SM2540C MOD: TOTAL DISSOLVED SOLIDS							Analyst: RBC
Total Dissolved Solids	1420	100	*D	mg/L	1	5/16/2023 8:30:00 AM	74912
SM 4500 NORG C: TKN							Analyst: RBC
Nitrogen, Kjeldahl, Total	ND	1.0		mg/L	1	5/18/2023 1:42:00 PM	75004

Refer to the QC Summary report and sample login checklist for flagged QC data and preservation information.

Qualifiers:	*	Value exceeds Maximum Contaminant Level.	B	Analyte detected in the associated Method Blank
	D	Sample Diluted Due to Matrix	E	Above Quantitation Range/Estimated Value
	H	Holding times for preparation or analysis exceeded	J	Analyte detected below quantitation limits
	ND	Not Detected at the Reporting Limit	P	Sample pH Not In Range
	PQL	Practical Quantitative Limit	RL	Reporting Limit
	S	% Recovery outside of standard limits. If undiluted results may be estimated.		

QC SUMMARY REPORT

Hall Environmental Analysis Laboratory, Inc.

WO#: 2305597

19-May-23

Client: EA Engineering
Project: Dominguez Dairy 2

Sample ID: MB	SampType: mblk	TestCode: EPA Method 300.0: Anions								
Client ID: PBW	Batch ID: R96705	RunNo: 96705								
Prep Date:	Analysis Date: 5/11/2023	SeqNo: 3506973 Units: mg/L								
Analyte	Result	PQL	SPK value	SPK Ref Val	%REC	LowLimit	HighLimit	%RPD	RPDLimit	Qual
Chloride	ND	0.50								
Nitrogen, Nitrite (As N)	ND	0.10								
Nitrogen, Nitrate (As N)	ND	0.10								

Sample ID: LCS	SampType: ics	TestCode: EPA Method 300.0: Anions								
Client ID: LCSW	Batch ID: R96705	RunNo: 96705								
Prep Date:	Analysis Date: 5/11/2023	SeqNo: 3506974 Units: mg/L								
Analyte	Result	PQL	SPK value	SPK Ref Val	%REC	LowLimit	HighLimit	%RPD	RPDLimit	Qual
Chloride	4.7	0.50	5.000	0	94.4	90	110			
Nitrogen, Nitrite (As N)	0.97	0.10	1.000	0	97.1	90	110			
Nitrogen, Nitrate (As N)	2.5	0.10	2.500	0	101	90	110			

Qualifiers:

*	Value exceeds Maximum Contaminant Level.	B	Analyte detected in the associated Method Blank
D	Sample Diluted Due to Matrix	E	Above Quantitation Range/Estimated Value
H	Holding times for preparation or analysis exceeded	J	Analyte detected below quantitation limits
ND	Not Detected at the Reporting Limit	P	Sample pH Not In Range
PQL	Practical Quantitative Limit	RL	Reporting Limit
S	% Recovery outside of standard limits. If undiluted results may be estimated.		

QC SUMMARY REPORT

Hall Environmental Analysis Laboratory, Inc.

WO#: 2305597

19-May-23

Client: EA Engineering
Project: Dominguez Dairy 2

Sample ID: MB-74912	SampType: MBLK	TestCode: SM2540C MOD: Total Dissolved Solids								
Client ID: PBW	Batch ID: 74912	RunNo: 96772								
Prep Date: 5/12/2023	Analysis Date: 5/16/2023	SeqNo: 3509272	Units: mg/L							
Analyte	Result	PQL	SPK value	SPK Ref Val	%REC	LowLimit	HighLimit	%RPD	RPDLimit	Qual
Total Dissolved Solids	ND	50.0								

Sample ID: LCS-74912	SampType: LCS	TestCode: SM2540C MOD: Total Dissolved Solids								
Client ID: LCSW	Batch ID: 74912	RunNo: 96772								
Prep Date: 5/12/2023	Analysis Date: 5/16/2023	SeqNo: 3509273	Units: mg/L							
Analyte	Result	PQL	SPK value	SPK Ref Val	%REC	LowLimit	HighLimit	%RPD	RPDLimit	Qual
Total Dissolved Solids	999	50.0	1000	0	99.9	80	120			

Qualifiers:

*	Value exceeds Maximum Contaminant Level.	B	Analyte detected in the associated Method Blank
D	Sample Diluted Due to Matrix	E	Above Quantitation Range/Estimated Value
H	Holding times for preparation or analysis exceeded	J	Analyte detected below quantitation limits
ND	Not Detected at the Reporting Limit	P	Sample pH Not In Range
PQL	Practical Quantitative Limit	RL	Reporting Limit
S	% Recovery outside of standard limits. If undiluted results may be estimated.		

QC SUMMARY REPORT

Hall Environmental Analysis Laboratory, Inc.

WO#: 2305597

19-May-23

Client: EA Engineering
Project: Dominguez Dairy 2

Sample ID: MB-74981	SampType: MBLK	TestCode: SM 4500 Norg C: TKN								
Client ID: PBW	Batch ID: 74981	RunNo: 96829								
Prep Date: 5/16/2023	Analysis Date: 5/17/2023	SeqNo: 3512069	Units: mg/L							
Analyte	Result	PQL	SPK value	SPK Ref Val	%REC	LowLimit	HighLimit	%RPD	RPDLimit	Qual
Nitrogen, Kjeldahl, Total	ND	1.0								

Sample ID: LCS-74981	SampType: LCS	TestCode: SM 4500 Norg C: TKN								
Client ID: LCSW	Batch ID: 74981	RunNo: 96829								
Prep Date: 5/16/2023	Analysis Date: 5/17/2023	SeqNo: 3512070	Units: mg/L							
Analyte	Result	PQL	SPK value	SPK Ref Val	%REC	LowLimit	HighLimit	%RPD	RPDLimit	Qual
Nitrogen, Kjeldahl, Total	9.8	1.0	10.00	0	98.0	80	120			

Sample ID: MB-75004	SampType: MBLK	TestCode: SM 4500 Norg C: TKN								
Client ID: PBW	Batch ID: 75004	RunNo: 96848								
Prep Date: 5/17/2023	Analysis Date: 5/18/2023	SeqNo: 3513149	Units: mg/L							
Analyte	Result	PQL	SPK value	SPK Ref Val	%REC	LowLimit	HighLimit	%RPD	RPDLimit	Qual
Nitrogen, Kjeldahl, Total	ND	1.0								

Sample ID: LCS-75004	SampType: LCS	TestCode: SM 4500 Norg C: TKN								
Client ID: LCSW	Batch ID: 75004	RunNo: 96848								
Prep Date: 5/17/2023	Analysis Date: 5/18/2023	SeqNo: 3513150	Units: mg/L							
Analyte	Result	PQL	SPK value	SPK Ref Val	%REC	LowLimit	HighLimit	%RPD	RPDLimit	Qual
Nitrogen, Kjeldahl, Total	9.7	1.0	10.00	0	96.6	80	120			

Qualifiers:

- | | |
|---|---|
| * Value exceeds Maximum Contaminant Level. | B Analyte detected in the associated Method Blank |
| D Sample Diluted Due to Matrix | E Above Quantitation Range/Estimated Value |
| H Holding times for preparation or analysis exceeded | J Analyte detected below quantitation limits |
| ND Not Detected at the Reporting Limit | P Sample pH Not In Range |
| PQL Practical Quantitative Limit | RL Reporting Limit |
| S % Recovery outside of standard limits. If undiluted results may be estimated. | |

Client Name: EA Engineering

Work Order Number: 2305597

RcptNo: 1

Received By: Desiree Dominguez 5/11/2023 8:50:00 AM

DD

Completed By: Desiree Dominguez 5/11/2023 9:31:05 AM

DD

Reviewed By: *WD 5/11/23*

Chain of Custody

1. Is Chain of Custody complete? Yes No Not Present
2. How was the sample delivered? FedEx

Log In

3. Was an attempt made to cool the samples? Yes No NA
4. Were all samples received at a temperature of >0° C to 6.0°C Yes No NA
5. Sample(s) in proper container(s)? Yes No
6. Sufficient sample volume for indicated test(s)? Yes No
7. Are samples (except VOA and ONG) properly preserved? Yes No
8. Was preservative added to bottles? Yes No NA
9. Received at least 1 vial with headspace <1/4" for AQ VOA? Yes No NA
10. Were any sample containers received broken? Yes No
11. Does paperwork match bottle labels?
 (Note discrepancies on chain of custody) Yes No
12. Are matrices correctly identified on Chain of Custody? Yes No
13. Is it clear what analyses were requested? Yes No
14. Were all holding times able to be met?
 (If no, notify customer for authorization.) Yes No

of preserved bottles checked for pH: 3
 (<2 or >12 unless noted)
 Adjusted? NO
 Checked by: WD 5/11/23

Special Handling (if applicable)

15. Was client notified of all discrepancies with this order? Yes No NA

Person Notified:	<input type="text"/>	Date:	<input type="text"/>
By Whom:	<input type="text"/>	Via:	<input type="checkbox"/> eMail <input type="checkbox"/> Phone <input type="checkbox"/> Fax <input type="checkbox"/> In Person
Regarding:	<input type="text"/>		
Client Instructions:	<input type="text"/>		

16. Additional remarks:

17. Cooler Information

Cooler No	Temp °C	Condition	Seal Intact	Seal No	Seal Date	Signed By
1	0.5	Good	Not Present	Morty		



Hall Environmental Analysis Laboratory
4901 Hawkins NE
Albuquerque, NM 87109
TEL: 505-345-3975 FAX: 505-345-4107
Website: www.hallenvironmental.com

May 23, 2023

Regina Mullen
EA Engineering
320 Gold Ave SW Suite 1210
Albuquerque, NM 87102
TEL:
FAX

RE: Dominguez Dairy 1

OrderNo.: 2305709

Dear Regina Mullen:

Hall Environmental Analysis Laboratory received 2 sample(s) on 5/12/2023 for the analyses presented in the following report.

These were analyzed according to EPA procedures or equivalent. To access our accredited tests please go to www.hallenvironmental.com or the state specific web sites. In order to properly interpret your results, it is imperative that you review this report in its entirety. See the sample checklist and/or the Chain of Custody for information regarding the sample receipt temperature and preservation. Data qualifiers or a narrative will be provided if the sample analysis or analytical quality control parameters require a flag. When necessary, data qualifiers are provided on both the sample analysis report and the QC summary report, both sections should be reviewed. All samples are reported, as received, unless otherwise indicated. Lab measurement of analytes considered field parameters that require analysis within 15 minutes of sampling such as pH and residual chlorine are qualified as being analyzed outside of the recommended holding time.

Please don't hesitate to contact HEAL for any additional information or clarifications.

ADHS Cert #AZ0682 -- NMED-DWB Cert #NM9425 -- NMED-Micro Cert #NM0901

Sincerely,

A handwritten signature in black ink, appearing to read 'Andy Freeman', is written in a cursive style.

Andy Freeman
Laboratory Manager
4901 Hawkins NE
Albuquerque, NM 87109

Hall Environmental Analysis Laboratory, Inc.

Analytical Report

Lab Order 2305709

Date Reported: 5/23/2023

CLIENT: EA Engineering

Client Sample ID: 624-09

Project: Dominguez Dairy 1

Collection Date: 5/11/2023 2:48:00 PM

Lab ID: 2305709-001

Matrix: AQUEOUS

Received Date: 5/12/2023 8:45:00 AM

Analyses	Result	RL	Qual	Units	DF	Date Analyzed	Batch
EPA METHOD 300.0: ANIONS							Analyst: JTT
Chloride	250	50	*	mg/L	100	5/13/2023 3:16:44 AM	R96731
Nitrogen, Nitrite (As N)	ND	1.0		mg/L	10	5/13/2023 3:04:22 AM	R96731
Nitrogen, Nitrate (As N)	ND	1.0		mg/L	10	5/13/2023 3:04:22 AM	R96731
SM2540C MOD: TOTAL DISSOLVED SOLIDS							Analyst: RBC
Total Dissolved Solids	1470	100	*D	mg/L	1	5/18/2023 3:45:00 PM	75000
SM 4500 NORG C: TKN							Analyst: DML
Nitrogen, Kjeldahl, Total	ND	1.0		mg/L	1	5/19/2023 2:40:00 PM	75005

Refer to the QC Summary report and sample login checklist for flagged QC data and preservation information.

Qualifiers:	*	Value exceeds Maximum Contaminant Level.	B	Analyte detected in the associated Method Blank
	D	Sample Diluted Due to Matrix	E	Above Quantitation Range/Estimated Value
	H	Holding times for preparation or analysis exceeded	J	Analyte detected below quantitation limits
	ND	Not Detected at the Reporting Limit	P	Sample pH Not In Range
	PQL	Practical Quantitative Limit	RL	Reporting Limit
	S	% Recovery outside of standard limits. If undiluted results may be estimated.		

Hall Environmental Analysis Laboratory, Inc.

Analytical Report

Lab Order 2305709

Date Reported: 5/23/2023

CLIENT: EA Engineering

Client Sample ID: 624-10

Project: Dominguez Dairy 1

Collection Date: 5/11/2023 3:56:00 PM

Lab ID: 2305709-002

Matrix: AQUEOUS

Received Date: 5/12/2023 8:45:00 AM

Analyses	Result	RL	Qual	Units	DF	Date Analyzed	Batch
EPA METHOD 300.0: ANIONS							Analyst: JTT
Chloride	690	50	*	mg/L	100	5/13/2023 3:41:26 AM	R96731
Nitrogen, Nitrite (As N)	ND	1.0		mg/L	10	5/13/2023 3:29:04 AM	R96731
Nitrogen, Nitrate (As N)	ND	1.0		mg/L	10	5/13/2023 3:29:04 AM	R96731
SM2540C MOD: TOTAL DISSOLVED SOLIDS							Analyst: RBC
Total Dissolved Solids	3240	100	*D	mg/L	1	5/18/2023 3:45:00 PM	75000
SM 4500 NORG C: TKN							Analyst: DML
Nitrogen, Kjeldahl, Total	1.1	1.0		mg/L	1	5/19/2023 2:40:00 PM	75005

Refer to the QC Summary report and sample login checklist for flagged QC data and preservation information.

Qualifiers:	*	Value exceeds Maximum Contaminant Level.	B	Analyte detected in the associated Method Blank
	D	Sample Diluted Due to Matrix	E	Above Quantitation Range/Estimated Value
	H	Holding times for preparation or analysis exceeded	J	Analyte detected below quantitation limits
	ND	Not Detected at the Reporting Limit	P	Sample pH Not In Range
	PQL	Practical Quantitative Limit	RL	Reporting Limit
	S	% Recovery outside of standard limits. If undiluted results may be estimated.		

QC SUMMARY REPORT

Hall Environmental Analysis Laboratory, Inc.

WO#: 2305709

23-May-23

Client: EA Engineering
Project: Dominguez Dairy 1

Sample ID: MB	SampType: MBLK	TestCode: EPA Method 300.0: Anions								
Client ID: PBW	Batch ID: R96731	RunNo: 96731								
Prep Date:	Analysis Date: 5/12/2023	SeqNo: 3507690 Units: mg/L								
Analyte	Result	PQL	SPK value	SPK Ref Val	%REC	LowLimit	HighLimit	%RPD	RPDLimit	Qual
Chloride	ND	0.50								
Nitrogen, Nitrite (As N)	ND	0.10								
Nitrogen, Nitrate (As N)	ND	0.10								

Sample ID: LCS	SampType: LCS	TestCode: EPA Method 300.0: Anions								
Client ID: LCSW	Batch ID: R96731	RunNo: 96731								
Prep Date:	Analysis Date: 5/12/2023	SeqNo: 3507691 Units: mg/L								
Analyte	Result	PQL	SPK value	SPK Ref Val	%REC	LowLimit	HighLimit	%RPD	RPDLimit	Qual
Chloride	4.9	0.50	5.000	0	97.4	90	110			
Nitrogen, Nitrite (As N)	0.98	0.10	1.000	0	98.0	90	110			
Nitrogen, Nitrate (As N)	2.6	0.10	2.500	0	103	90	110			

Qualifiers:

*	Value exceeds Maximum Contaminant Level.	B	Analyte detected in the associated Method Blank
D	Sample Diluted Due to Matrix	E	Above Quantitation Range/Estimated Value
H	Holding times for preparation or analysis exceeded	J	Analyte detected below quantitation limits
ND	Not Detected at the Reporting Limit	P	Sample pH Not In Range
PQL	Practical Quantitative Limit	RL	Reporting Limit
S	% Recovery outside of standard limits. If undiluted results may be estimated.		

QC SUMMARY REPORT

Hall Environmental Analysis Laboratory, Inc.

WO#: 2305709

23-May-23

Client: EA Engineering
Project: Dominguez Dairy 1

Sample ID: MB-75000	SampType: MBLK	TestCode: SM2540C MOD: Total Dissolved Solids								
Client ID: PBW	Batch ID: 75000	RunNo: 96847								
Prep Date: 5/17/2023	Analysis Date: 5/18/2023	SeqNo: 3513126	Units: mg/L							
Analyte	Result	PQL	SPK value	SPK Ref Val	%REC	LowLimit	HighLimit	%RPD	RPDLimit	Qual
Total Dissolved Solids	ND	50.0								

Sample ID: LCS-75000	SampType: LCS	TestCode: SM2540C MOD: Total Dissolved Solids								
Client ID: LCSW	Batch ID: 75000	RunNo: 96847								
Prep Date: 5/17/2023	Analysis Date: 5/18/2023	SeqNo: 3513127	Units: mg/L							
Analyte	Result	PQL	SPK value	SPK Ref Val	%REC	LowLimit	HighLimit	%RPD	RPDLimit	Qual
Total Dissolved Solids	983	50.0	1000	0	98.3	80	120			

Qualifiers:

*	Value exceeds Maximum Contaminant Level.	B	Analyte detected in the associated Method Blank
D	Sample Diluted Due to Matrix	E	Above Quantitation Range/Estimated Value
H	Holding times for preparation or analysis exceeded	J	Analyte detected below quantitation limits
ND	Not Detected at the Reporting Limit	P	Sample pH Not In Range
PQL	Practical Quantitative Limit	RL	Reporting Limit
S	% Recovery outside of standard limits. If undiluted results may be estimated.		

QC SUMMARY REPORT

Hall Environmental Analysis Laboratory, Inc.

WO#: 2305709

23-May-23

Client: EA Engineering
Project: Dominguez Dairy 1

Sample ID: MB-75005	SampType: MBLK	TestCode: SM 4500 Norg C: TKN								
Client ID: PBW	Batch ID: 75005	RunNo: 96902								
Prep Date: 5/17/2023	Analysis Date: 5/19/2023	SeqNo: 3515229 Units: mg/L								
Analyte	Result	PQL	SPK value	SPK Ref Val	%REC	LowLimit	HighLimit	%RPD	RPDLimit	Qual
Nitrogen, Kjeldahl, Total	ND	1.0								

Sample ID: LCS-75005	SampType: LCS	TestCode: SM 4500 Norg C: TKN								
Client ID: LCSW	Batch ID: 75005	RunNo: 96902								
Prep Date: 5/17/2023	Analysis Date: 5/19/2023	SeqNo: 3515230 Units: mg/L								
Analyte	Result	PQL	SPK value	SPK Ref Val	%REC	LowLimit	HighLimit	%RPD	RPDLimit	Qual
Nitrogen, Kjeldahl, Total	9.9	1.0	10.00	0	99.4	80	120			

Qualifiers:

*	Value exceeds Maximum Contaminant Level.	B	Analyte detected in the associated Method Blank
D	Sample Diluted Due to Matrix	E	Above Quantitation Range/Estimated Value
H	Holding times for preparation or analysis exceeded	J	Analyte detected below quantitation limits
ND	Not Detected at the Reporting Limit	P	Sample pH Not In Range
PQL	Practical Quantitative Limit	RL	Reporting Limit
S	% Recovery outside of standard limits. If undiluted results may be estimated.		

Sample Log-In Check List

Client Name: EA Engineering

Work Order Number: 2305709

RcptNo: 1

Received By: Joseph Alderette 5/12/2023 8:45:00 AM

Completed By: Cheyenne Cason 5/12/2023 11:10:21 AM

Reviewed By: *WA* 5/12/23

JH
Chad

Chain of Custody

1. Is Chain of Custody complete? Yes No Not Present
2. How was the sample delivered? FedEx

Log In

3. Was an attempt made to cool the samples? Yes No NA
4. Were all samples received at a temperature of >0° C to 6.0°C Yes No NA
5. Sample(s) in proper container(s)? Yes No
6. Sufficient sample volume for indicated test(s)? Yes No
7. Are samples (except VOA and ONG) properly preserved? Yes No
8. Was preservative added to bottles? Yes No NA
9. Received at least 1 vial with headspace <1/4" for AQ VOA? Yes No NA
10. Were any sample containers received broken? Yes No
11. Does paperwork match bottle labels? Yes No
 (Note discrepancies on chain of custody)
12. Are matrices correctly identified on Chain of Custody? Yes No
13. Is it clear what analyses were requested? Yes No
14. Were all holding times able to be met? Yes No
 (If no, notify customer for authorization.)

of preserved bottles checked for pH: 2
 (<2 or >12 unless noted)
 Adjusted? NO
 Checked by: KPG 5.12.23

Special Handling (if applicable)

15. Was client notified of all discrepancies with this order? Yes No NA

Person Notified:	<input type="text"/>	Date:	<input type="text"/>
By Whom:	<input type="text"/>	Via:	<input type="checkbox"/> eMail <input type="checkbox"/> Phone <input type="checkbox"/> Fax <input type="checkbox"/> In Person
Regarding:	<input type="text"/>		
Client Instructions:	<input type="text"/>		

16. Additional remarks:

17. Cooler Information

Cooler No	Temp °C	Condition	Seal Intact	Seal No	Seal Date	Signed By
1	1.9	Good	Not Present	Yogi		



Hall Environmental Analysis Laboratory
4901 Hawkins NE
Albuquerque, NM 87109
TEL: 505-345-3975 FAX: 505-345-4107
Website: www.hallenvironmental.com

May 19, 2023

Regina Mullen
EA Engineering
320 Gold Ave SW Suite 1210
Albuquerque, NM 87102
TEL:
FAX

RE: Dominguez Dairy 2

OrderNo.: 2305711

Dear Regina Mullen:

Hall Environmental Analysis Laboratory received 2 sample(s) on 5/12/2023 for the analyses presented in the following report.

These were analyzed according to EPA procedures or equivalent. To access our accredited tests please go to www.hallenvironmental.com or the state specific web sites. In order to properly interpret your results, it is imperative that you review this report in its entirety. See the sample checklist and/or the Chain of Custody for information regarding the sample receipt temperature and preservation. Data qualifiers or a narrative will be provided if the sample analysis or analytical quality control parameters require a flag. When necessary, data qualifiers are provided on both the sample analysis report and the QC summary report, both sections should be reviewed. All samples are reported, as received, unless otherwise indicated. Lab measurement of analytes considered field parameters that require analysis within 15 minutes of sampling such as pH and residual chlorine are qualified as being analyzed outside of the recommended holding time.

Please don't hesitate to contact HEAL for any additional information or clarifications.

ADHS Cert #AZ0682 -- NMED-DWB Cert #NM9425 -- NMED-Micro Cert #NM0901

Sincerely,

A handwritten signature in black ink, appearing to read 'Andy Freeman', is written in a cursive style.

Andy Freeman
Laboratory Manager
4901 Hawkins NE
Albuquerque, NM 87109

Hall Environmental Analysis Laboratory, Inc.

Analytical Report

Lab Order 2305711

Date Reported: 5/19/2023

CLIENT: EA Engineering

Client Sample ID: 42-12

Project: Dominguez Dairy 2

Collection Date: 5/11/2023 10:41:00 AM

Lab ID: 2305711-001

Matrix: GROUNDWA

Received Date: 5/12/2023 8:45:00 AM

Analyses	Result	RL	Qual	Units	DF	Date Analyzed	Batch
EPA METHOD 300.0: ANIONS							Analyst: JTT
Chloride	250	50		mg/L	100	5/12/2023 11:28:40 PM	A96732
Nitrogen, Nitrite (As N)	ND	1.0		mg/L	10	5/12/2023 11:15:48 PM	A96732
Nitrogen, Nitrate (As N)	ND	1.0		mg/L	10	5/12/2023 11:15:48 PM	A96732
SM2540C MOD: TOTAL DISSOLVED SOLIDS							Analyst: RBC
Total Dissolved Solids	1010	100	*D	mg/L	1	5/18/2023 3:45:00 PM	75000
SM 4500 NORG C: TKN							Analyst: RBC
Nitrogen, Kjeldahl, Total	ND	1.0		mg/L	1	5/18/2023 1:42:00 PM	75004

Refer to the QC Summary report and sample login checklist for flagged QC data and preservation information.

Qualifiers:	*	Value exceeds Maximum Contaminant Level.	B	Analyte detected in the associated Method Blank
	D	Sample Diluted Due to Matrix	E	Above Quantitation Range/Estimated Value
	H	Holding times for preparation or analysis exceeded	J	Analyte detected below quantitation limits
	ND	Not Detected at the Reporting Limit	P	Sample pH Not In Range
	PQL	Practical Quantitative Limit	RL	Reporting Limit
	S	% Recovery outside of standard limits. If undiluted results may be estimated.		

Hall Environmental Analysis Laboratory, Inc.

Analytical Report

Lab Order 2305711

Date Reported: 5/19/2023

CLIENT: EA Engineering

Client Sample ID: 42-10

Project: Dominguez Dairy 2

Collection Date: 5/11/2023 12:53:00 PM

Lab ID: 2305711-002

Matrix: GROUNDWA

Received Date: 5/12/2023 8:45:00 AM

Analyses	Result	RL	Qual	Units	DF	Date Analyzed	Batch
EPA METHOD 300.0: ANIONS							Analyst: JTT
Chloride	410	50	*	mg/L	100	5/12/2023 11:54:23 PM	A96732
Nitrogen, Nitrite (As N)	ND	1.0		mg/L	10	5/12/2023 11:41:32 PM	A96732
Nitrogen, Nitrate (As N)	7.9	1.0		mg/L	10	5/12/2023 11:41:32 PM	A96732
SM2540C MOD: TOTAL DISSOLVED SOLIDS							Analyst: RBC
Total Dissolved Solids	1610	100	*D	mg/L	1	5/18/2023 3:45:00 PM	75000
SM 4500 NORG C: TKN							Analyst: RBC
Nitrogen, Kjeldahl, Total	ND	1.0		mg/L	1	5/18/2023 1:42:00 PM	75004

Refer to the QC Summary report and sample login checklist for flagged QC data and preservation information.

Qualifiers:	*	Value exceeds Maximum Contaminant Level.	B	Analyte detected in the associated Method Blank
	D	Sample Diluted Due to Matrix	E	Above Quantitation Range/Estimated Value
	H	Holding times for preparation or analysis exceeded	J	Analyte detected below quantitation limits
	ND	Not Detected at the Reporting Limit	P	Sample pH Not In Range
	PQL	Practical Quantitative Limit	RL	Reporting Limit
	S	% Recovery outside of standard limits. If undiluted results may be estimated.		

QC SUMMARY REPORT

Hall Environmental Analysis Laboratory, Inc.

WO#: 2305711

19-May-23

Client: EA Engineering
Project: Dominguez Dairy 2

Sample ID: MB	SampType: MBLK	TestCode: EPA Method 300.0: Anions								
Client ID: PBW	Batch ID: A96732	RunNo: 96732								
Prep Date:	Analysis Date: 5/12/2023	SeqNo: 3507804 Units: mg/L								
Analyte	Result	PQL	SPK value	SPK Ref Val	%REC	LowLimit	HighLimit	%RPD	RPDLimit	Qual
Chloride	ND	0.50								
Nitrogen, Nitrite (As N)	ND	0.10								
Nitrogen, Nitrate (As N)	ND	0.10								

Sample ID: LCS	SampType: LCS	TestCode: EPA Method 300.0: Anions								
Client ID: LCSW	Batch ID: A96732	RunNo: 96732								
Prep Date:	Analysis Date: 5/12/2023	SeqNo: 3507805 Units: mg/L								
Analyte	Result	PQL	SPK value	SPK Ref Val	%REC	LowLimit	HighLimit	%RPD	RPDLimit	Qual
Chloride	4.8	0.50	5.000	0	96.2	90	110			
Nitrogen, Nitrite (As N)	0.98	0.10	1.000	0	98.4	90	110			
Nitrogen, Nitrate (As N)	2.5	0.10	2.500	0	101	90	110			

Qualifiers:

*	Value exceeds Maximum Contaminant Level.	B	Analyte detected in the associated Method Blank
D	Sample Diluted Due to Matrix	E	Above Quantitation Range/Estimated Value
H	Holding times for preparation or analysis exceeded	J	Analyte detected below quantitation limits
ND	Not Detected at the Reporting Limit	P	Sample pH Not In Range
PQL	Practical Quantitative Limit	RL	Reporting Limit
S	% Recovery outside of standard limits. If undiluted results may be estimated.		

QC SUMMARY REPORT

Hall Environmental Analysis Laboratory, Inc.

WO#: 2305711

19-May-23

Client: EA Engineering
Project: Dominguez Dairy 2

Sample ID: MB-75000	SampType: MBLK	TestCode: SM2540C MOD: Total Dissolved Solids								
Client ID: PBW	Batch ID: 75000	RunNo: 96847								
Prep Date: 5/17/2023	Analysis Date: 5/18/2023	SeqNo: 3513126	Units: mg/L							
Analyte	Result	PQL	SPK value	SPK Ref Val	%REC	LowLimit	HighLimit	%RPD	RPDLimit	Qual
Total Dissolved Solids	ND	50.0								

Sample ID: LCS-75000	SampType: LCS	TestCode: SM2540C MOD: Total Dissolved Solids								
Client ID: LCSW	Batch ID: 75000	RunNo: 96847								
Prep Date: 5/17/2023	Analysis Date: 5/18/2023	SeqNo: 3513127	Units: mg/L							
Analyte	Result	PQL	SPK value	SPK Ref Val	%REC	LowLimit	HighLimit	%RPD	RPDLimit	Qual
Total Dissolved Solids	983	50.0	1000	0	98.3	80	120			

Sample ID: 2305711-002ADUP	SampType: DUP	TestCode: SM2540C MOD: Total Dissolved Solids								
Client ID: 42-10	Batch ID: 75000	RunNo: 96847								
Prep Date: 5/17/2023	Analysis Date: 5/18/2023	SeqNo: 3513134	Units: mg/L							
Analyte	Result	PQL	SPK value	SPK Ref Val	%REC	LowLimit	HighLimit	%RPD	RPDLimit	Qual
Total Dissolved Solids	1590	100						1.13	10	*D

Qualifiers:

- | | |
|---|---|
| * Value exceeds Maximum Contaminant Level. | B Analyte detected in the associated Method Blank |
| D Sample Diluted Due to Matrix | E Above Quantitation Range/Estimated Value |
| H Holding times for preparation or analysis exceeded | J Analyte detected below quantitation limits |
| ND Not Detected at the Reporting Limit | P Sample pH Not In Range |
| PQL Practical Quantitative Limit | RL Reporting Limit |
| S % Recovery outside of standard limits. If undiluted results may be estimated. | |

QC SUMMARY REPORT

Hall Environmental Analysis Laboratory, Inc.

WO#: 2305711

19-May-23

Client: EA Engineering
Project: Dominguez Dairy 2

Sample ID: MB-75004	SampType: MBLK	TestCode: SM 4500 Norg C: TKN								
Client ID: PBW	Batch ID: 75004	RunNo: 96848								
Prep Date: 5/17/2023	Analysis Date: 5/18/2023	SeqNo: 3513149 Units: mg/L								
Analyte	Result	PQL	SPK value	SPK Ref Val	%REC	LowLimit	HighLimit	%RPD	RPDLimit	Qual
Nitrogen, Kjeldahl, Total	ND	1.0								

Sample ID: LCS-75004	SampType: LCS	TestCode: SM 4500 Norg C: TKN								
Client ID: LCSW	Batch ID: 75004	RunNo: 96848								
Prep Date: 5/17/2023	Analysis Date: 5/18/2023	SeqNo: 3513150 Units: mg/L								
Analyte	Result	PQL	SPK value	SPK Ref Val	%REC	LowLimit	HighLimit	%RPD	RPDLimit	Qual
Nitrogen, Kjeldahl, Total	9.7	1.0	10.00	0	96.6	80	120			

Qualifiers:

*	Value exceeds Maximum Contaminant Level.	B	Analyte detected in the associated Method Blank
D	Sample Diluted Due to Matrix	E	Above Quantitation Range/Estimated Value
H	Holding times for preparation or analysis exceeded	J	Analyte detected below quantitation limits
ND	Not Detected at the Reporting Limit	P	Sample pH Not In Range
PQL	Practical Quantitative Limit	RL	Reporting Limit
S	% Recovery outside of standard limits. If undiluted results may be estimated.		

Sample Log-In Check List

Client Name: EA Engineering

Work Order Number: 2305711

RcptNo: 1

Received By: Joseph Alderette 5/12/2023 8:45:00 AM

Completed By: Cheyenne Cason 5/12/2023 11:21:44 AM

Reviewed By: *JM 5-12-23*

JH
CC

Chain of Custody

1. Is Chain of Custody complete? Yes No Not Present

2. How was the sample delivered? FedEx

Log In

3. Was an attempt made to cool the samples? Yes No NA

4. Were all samples received at a temperature of >0° C to 6.0°C Yes No NA

5. Sample(s) in proper container(s)? Yes No

6. Sufficient sample volume for indicated test(s)? Yes No

7. Are samples (except VOA and ONG) properly preserved? Yes No

8. Was preservative added to bottles? Yes No NA

9. Received at least 1 vial with headspace <1/4" for AQ VOA? Yes No NA

10. Were any sample containers received broken? Yes No

11. Does paperwork match bottle labels? Yes No

(Note discrepancies on chain of custody)

12. Are matrices correctly identified on Chain of Custody? Yes No

13. Is it clear what analyses were requested? Yes No

14. Were all holding times able to be met? Yes No

(If no, notify customer for authorization.)

of preserved bottles checked 2
 for pH: (2 or >12 unless noted)
 Adjusted? NO
 Checked by: JM 5/12/23

Special Handling (if applicable)

15. Was client notified of all discrepancies with this order? Yes No NA

Person Notified:	<input type="text"/>	Date:	<input type="text"/>
By Whom:	<input type="text"/>	Via:	<input type="checkbox"/> eMail <input type="checkbox"/> Phone <input type="checkbox"/> Fax <input type="checkbox"/> In Person
Regarding:	<input type="text"/>		
Client Instructions:	<input type="text"/>		

16. Additional remarks:

17. Cooler Information

Cooler No	Temp °C	Condition	Seal Intact	Seal No	Seal Date	Signed By
1	1.9	Good	Not Present	Yogi		



HALL ENVIRONMENTAL ANALYSIS LABORATORY
 www.hallenvironmental.com
 4901 Hawkins NE - Albuquerque, NM 87109
 Tel. 505-345-3975 Fax 505-345-4107

Analysis Request

Turn-Around Time: Standard Rush
 Project Name: Dominguez Dairy 2
 Project #: _____

Project Manager: Gina Mullen
 Sampler: Angel N. Rivera
 On Ice: Yes No
 # of Coolers: 1
 Cooler Temp (including CF): 1.7 + 0.2 = 1.9°C

Container Type and #	Preservative Type	HEAL No.
2		2305711
2		001
		002

Client: EA Engineering, Science, and Technology
 Mailing Address: 320 Gold Ave SW Suite
 Phone #: 505-715-4279
 email or Fax#: rmullen@eaest.com

QA/QC Package: Standard Level 4 (Full Validation)
 Accreditation: Az Compliance NELAC Other
 EDD (Type)

Date	Time	Matrix	Sample Name
5-11	10:41	Gw	42-12
5-11	12:53	Gw	42-10

Project Manager: Gina Mullen
 Project Name: Dominguez Dairy 2
 Project #: _____

Project Manager: Gina Mullen
 Sampler: Angel N. Rivera
 On Ice: Yes No
 # of Coolers: 1
 Cooler Temp (including CF): 1.7 + 0.2 = 1.9°C

Date	Time	Matrix	Sample Name
5-11	10:41	Gw	42-12
5-11	12:53	Gw	42-10

Turn-Around Time: Standard Rush

Project Name: Dominguez Dairy 2

Analysis Request
Nitrate/Nitrites EPA Method 300
TKN SM 4500 NORG C
Chloride EPA 300
TDS SM 2540 C MOD
Sulfate EPA 300
Phosphorus EPA 6010B
Total Sulfur

Received by: [Signature] Via: FedEx Date: 5-12-23 Time: 8:45
 Relinquished by: [Signature] Date: _____ Time: _____

If necessary, samples submitted to Hall Environmental may be subcontracted to other accredited laboratories. This serves as notice of this possibility. Any sub-contracted data will be clearly notated on the analytical report.



Hall Environmental Analysis Laboratory
4901 Hawkins NE
Albuquerque, NM 87109
TEL: 505-345-3975 FAX: 505-345-4107
Website: www.hallenvironmental.com

May 24, 2023

Regina Mullen
EA Engineering
320 Gold Ave SW Suite 1210
Albuquerque, NM 87102
TEL:
FAX:

RE: Buena Vista Dairy 2

OrderNo.: 2305761

Dear Regina Mullen:

Hall Environmental Analysis Laboratory received 2 sample(s) on 5/15/2023 for the analyses presented in the following report.

These were analyzed according to EPA procedures or equivalent. To access our accredited tests please go to www.hallenvironmental.com or the state specific web sites. In order to properly interpret your results, it is imperative that you review this report in its entirety. See the sample checklist and/or the Chain of Custody for information regarding the sample receipt temperature and preservation. Data qualifiers or a narrative will be provided if the sample analysis or analytical quality control parameters require a flag. When necessary, data qualifiers are provided on both the sample analysis report and the QC summary report, both sections should be reviewed. All samples are reported, as received, unless otherwise indicated. Lab measurement of analytes considered field parameters that require analysis within 15 minutes of sampling such as pH and residual chlorine are qualified as being analyzed outside of the recommended holding time.

Please don't hesitate to contact HEAL for any additional information or clarifications.

ADHS Cert #AZ0682 -- NMED-DWB Cert #NM9425 -- NMED-Micro Cert #NM0901

Sincerely,

A handwritten signature in black ink, appearing to read 'Andy Freeman', is written in a cursive style.

Andy Freeman
Laboratory Manager
4901 Hawkins NE
Albuquerque, NM 87109

Hall Environmental Analysis Laboratory, Inc.

Analytical Report

Lab Order 2305761

Date Reported: 5/24/2023

CLIENT: EA Engineering

Client Sample ID: 74-03

Project: Buena Vista Dairy 2

Collection Date: 5/12/2023 2:38:00 PM

Lab ID: 2305761-001

Matrix: GROUNDWA

Received Date: 5/15/2023 8:24:00 AM

Analyses	Result	RL	Qual	Units	DF	Date Analyzed	Batch
EPA METHOD 300.0: ANIONS							Analyst: NAI
Chloride	250	50		mg/L	100	5/15/2023 3:57:48 PM	R96779
Nitrate+Nitrite as N	ND	1.0		mg/L	5	5/15/2023 10:16:44 PM	R96779
SM2540C MOD: TOTAL DISSOLVED SOLIDS							Analyst: RBC
Total Dissolved Solids	1670	100	*D	mg/L	1	5/18/2023 3:45:00 PM	75000
SM 4500 NORG C: TKN							Analyst: RBC
Nitrogen, Kjeldahl, Total	ND	1.0		mg/L	1	5/19/2023 2:35:00 PM	75027

Refer to the QC Summary report and sample login checklist for flagged QC data and preservation information.

Qualifiers:	*	Value exceeds Maximum Contaminant Level.	B	Analyte detected in the associated Method Blank
	D	Sample Diluted Due to Matrix	E	Above Quantitation Range/Estimated Value
	H	Holding times for preparation or analysis exceeded	J	Analyte detected below quantitation limits
	ND	Not Detected at the Reporting Limit	P	Sample pH Not In Range
	PQL	Practical Quantitative Limit	RL	Reporting Limit
	S	% Recovery outside of standard limits. If undiluted results may be estimated.		

Hall Environmental Analysis Laboratory, Inc.

Analytical Report

Lab Order 2305761

Date Reported: 5/24/2023

CLIENT: EA Engineering

Client Sample ID: 74-02

Project: Buena Vista Dairy 2

Collection Date: 5/12/2023 3:45:00 PM

Lab ID: 2305761-002

Matrix: GROUNDWA

Received Date: 5/15/2023 8:24:00 AM

Analyses	Result	RL	Qual	Units	DF	Date Analyzed	Batch
EPA METHOD 300.0: ANIONS							Analyst: NAI
Chloride	650	50	*	mg/L	100	5/15/2023 4:49:15 PM	R96779
Nitrate+Nitrite as N	1.3	1.0		mg/L	5	5/15/2023 10:29:35 PM	R96779
SM2540C MOD: TOTAL DISSOLVED SOLIDS							Analyst: RBC
Total Dissolved Solids	2500	100	*D	mg/L	1	5/18/2023 3:45:00 PM	75000
SM 4500 NORG C: TKN							Analyst: RBC
Nitrogen, Kjeldahl, Total	2.2	1.0		mg/L	1	5/19/2023 2:35:00 PM	75027

Refer to the QC Summary report and sample login checklist for flagged QC data and preservation information.

Qualifiers:	*	Value exceeds Maximum Contaminant Level.	B	Analyte detected in the associated Method Blank
	D	Sample Diluted Due to Matrix	E	Above Quantitation Range/Estimated Value
	H	Holding times for preparation or analysis exceeded	J	Analyte detected below quantitation limits
	ND	Not Detected at the Reporting Limit	P	Sample pH Not In Range
	PQL	Practical Quantitative Limit	RL	Reporting Limit
	S	% Recovery outside of standard limits. If undiluted results may be estimated.		

QC SUMMARY REPORT

Hall Environmental Analysis Laboratory, Inc.

WO#: 2305761

24-May-23

Client: EA Engineering
Project: Buena Vista Dairy 2

Sample ID: MB	SampType: mblk	TestCode: EPA Method 300.0: Anions								
Client ID: PBW	Batch ID: R96779	RunNo: 96779								
Prep Date:	Analysis Date: 5/15/2023	SeqNo: 3510005			Units: mg/L					
Analyte	Result	PQL	SPK value	SPK Ref Val	%REC	LowLimit	HighLimit	%RPD	RPDLimit	Qual
Chloride	ND	0.50								
Nitrate+Nitrite as N	ND	0.20								

Sample ID: LCS	SampType: lcs	TestCode: EPA Method 300.0: Anions								
Client ID: LCSW	Batch ID: R96779	RunNo: 96779								
Prep Date:	Analysis Date: 5/15/2023	SeqNo: 3510006			Units: mg/L					
Analyte	Result	PQL	SPK value	SPK Ref Val	%REC	LowLimit	HighLimit	%RPD	RPDLimit	Qual
Chloride	4.7	0.50	5.000	0	93.6	90	110			
Nitrate+Nitrite as N	3.5	0.20	3.500	0	99.0	90	110			

Qualifiers:

- | | |
|---|---|
| * Value exceeds Maximum Contaminant Level. | B Analyte detected in the associated Method Blank |
| D Sample Diluted Due to Matrix | E Above Quantitation Range/Estimated Value |
| H Holding times for preparation or analysis exceeded | J Analyte detected below quantitation limits |
| ND Not Detected at the Reporting Limit | P Sample pH Not In Range |
| PQL Practical Quantitative Limit | RL Reporting Limit |
| S % Recovery outside of standard limits. If undiluted results may be estimated. | |

QC SUMMARY REPORT

Hall Environmental Analysis Laboratory, Inc.

WO#: 2305761

24-May-23

Client: EA Engineering
Project: Buena Vista Dairy 2

Sample ID: MB-75000	SampType: MBLK	TestCode: SM2540C MOD: Total Dissolved Solids								
Client ID: PBW	Batch ID: 75000	RunNo: 96847								
Prep Date: 5/17/2023	Analysis Date: 5/18/2023	SeqNo: 3513126	Units: mg/L							
Analyte	Result	PQL	SPK value	SPK Ref Val	%REC	LowLimit	HighLimit	%RPD	RPDLimit	Qual
Total Dissolved Solids	ND	50.0								

Sample ID: LCS-75000	SampType: LCS	TestCode: SM2540C MOD: Total Dissolved Solids								
Client ID: LCSW	Batch ID: 75000	RunNo: 96847								
Prep Date: 5/17/2023	Analysis Date: 5/18/2023	SeqNo: 3513127	Units: mg/L							
Analyte	Result	PQL	SPK value	SPK Ref Val	%REC	LowLimit	HighLimit	%RPD	RPDLimit	Qual
Total Dissolved Solids	983	50.0	1000	0	98.3	80	120			

Qualifiers:

- * Value exceeds Maximum Contaminant Level.
- D Sample Diluted Due to Matrix
- H Holding times for preparation or analysis exceeded
- ND Not Detected at the Reporting Limit
- PQL Practical Quantitative Limit
- S % Recovery outside of standard limits. If undiluted results may be estimated.
- B Analyte detected in the associated Method Blank
- E Above Quantitation Range/Estimated Value
- J Analyte detected below quantitation limits
- P Sample pH Not In Range
- RL Reporting Limit

QC SUMMARY REPORT

Hall Environmental Analysis Laboratory, Inc.

WO#: 2305761

24-May-23

Client: EA Engineering
Project: Buena Vista Dairy 2

Sample ID: MB-75027	SampType: MBLK	TestCode: SM 4500 Norg C: TKN								
Client ID: PBW	Batch ID: 75027	RunNo: 96905								
Prep Date: 5/18/2023	Analysis Date: 5/19/2023	SeqNo: 3515278	Units: mg/L							
Analyte	Result	PQL	SPK value	SPK Ref Val	%REC	LowLimit	HighLimit	%RPD	RPDLimit	Qual
Nitrogen, Kjeldahl, Total	ND	1.0								

Sample ID: LCS-75027	SampType: LCS	TestCode: SM 4500 Norg C: TKN								
Client ID: LCSW	Batch ID: 75027	RunNo: 96905								
Prep Date: 5/18/2023	Analysis Date: 5/19/2023	SeqNo: 3515279	Units: mg/L							
Analyte	Result	PQL	SPK value	SPK Ref Val	%REC	LowLimit	HighLimit	%RPD	RPDLimit	Qual
Nitrogen, Kjeldahl, Total	9.7	1.0	10.00	0	96.6	80	120			

Qualifiers:

- * Value exceeds Maximum Contaminant Level.
- D Sample Diluted Due to Matrix
- H Holding times for preparation or analysis exceeded
- ND Not Detected at the Reporting Limit
- PQL Practical Quantitative Limit
- S % Recovery outside of standard limits. If undiluted results may be estimated.
- B Analyte detected in the associated Method Blank
- E Above Quantitation Range/Estimated Value
- J Analyte detected below quantitation limits
- P Sample pH Not In Range
- RL Reporting Limit

Sample Log-In Check List

Client Name: EA Engineering

Work Order Number: 2305761

RcptNo: 1

Received By: Nancy Proctor 5/15/2023 8:24:00 AM

Completed By: Cheyenne Cason 5/15/2023 10:18:19 AM *CC*

Reviewed By: *WA 5/15/23*

Chain of Custody

1. Is Chain of Custody complete? Yes No Not Present
2. How was the sample delivered? FedEx

Log In

3. Was an attempt made to cool the samples? Yes No NA
4. Were all samples received at a temperature of >0° C to 6.0°C Yes No NA
5. Sample(s) in proper container(s)? Yes No Approved by client.
6. Sufficient sample volume for indicated test(s)? Yes No
7. Are samples (except VOA and ONG) properly preserved? Yes No
8. Was preservative added to bottles? Yes No NA
9. Received at least 1 vial with headspace <1/4" for AQ VOA? Yes No NA
10. Were any sample containers received broken? Yes No
11. Does paperwork match bottle labels? Yes No
 (Note discrepancies on chain of custody)
12. Are matrices correctly identified on Chain of Custody? Yes No
13. Is it clear what analyses were requested? Yes No
14. Were all holding times able to be met? Yes No
 (If no, notify customer for authorization.)

of preserved bottles checked for pH: 2
 (<2 or >12 unless noted)
 Adjusted? NO
 Checked by: WA 5/15/23

Special Handling (if applicable)

15. Was client notified of all discrepancies with this order? Yes No NA

Person Notified:	Gina Mullen	Date:	5/15/2023
By Whom:	Cheyenne Cason	Via:	<input type="checkbox"/> eMail <input checked="" type="checkbox"/> Phone <input type="checkbox"/> Fax <input type="checkbox"/> In Person
Regarding:	LVM Samples recieved out of temp. continuing with run		
Client Instructions:			

16. Additional remarks:

17. Cooler Information

Cooler No	Temp °C	Condition	Seal Intact	Seal No	Seal Date	Signed By
1	7.5	Good	Not Present	Morty		



Hall Environmental Analysis Laboratory
4901 Hawkins NE
Albuquerque, NM 87109
TEL: 505-345-3975 FAX: 505-345-4107
Website: www.hallenvironmental.com

May 24, 2023

Regina Mullen
EA Engineering
320 Gold Ave SW Suite 1210
Albuquerque, NM 87102
TEL:
FAX:

RE: Dominguez Dairy 1

OrderNo.: 2305763

Dear Regina Mullen:

Hall Environmental Analysis Laboratory received 3 sample(s) on 5/15/2023 for the analyses presented in the following report.

These were analyzed according to EPA procedures or equivalent. To access our accredited tests please go to www.hallenvironmental.com or the state specific web sites. In order to properly interpret your results, it is imperative that you review this report in its entirety. See the sample checklist and/or the Chain of Custody for information regarding the sample receipt temperature and preservation. Data qualifiers or a narrative will be provided if the sample analysis or analytical quality control parameters require a flag. When necessary, data qualifiers are provided on both the sample analysis report and the QC summary report, both sections should be reviewed. All samples are reported, as received, unless otherwise indicated. Lab measurement of analytes considered field parameters that require analysis within 15 minutes of sampling such as pH and residual chlorine are qualified as being analyzed outside of the recommended holding time.

Please don't hesitate to contact HEAL for any additional information or clarifications.

ADHS Cert #AZ0682 -- NMED-DWB Cert #NM9425 -- NMED-Micro Cert #NM0901

Sincerely,

A handwritten signature in black ink, appearing to read 'Andy Freeman', is written in a cursive style.

Andy Freeman
Laboratory Manager
4901 Hawkins NE
Albuquerque, NM 87109

Hall Environmental Analysis Laboratory, Inc.

Analytical Report

Lab Order 2305763

Date Reported: 5/24/2023

CLIENT: EA Engineering

Client Sample ID: 624-11

Project: Dominguez Dairy 1

Collection Date: 5/12/2023 10:52:00 AM

Lab ID: 2305763-001

Matrix: GROUNDWA

Received Date: 5/15/2023 8:24:00 AM

Analyses	Result	RL	Qual	Units	DF	Date Analyzed	Batch
EPA METHOD 300.0: ANIONS							Analyst: NAI
Chloride	1300	50	*	mg/L	100	5/15/2023 7:55:09 PM	R96779
Nitrate+Nitrite as N	8.9	1.0		mg/L	5	5/15/2023 8:59:28 PM	R96779
SM2540C MOD: TOTAL DISSOLVED SOLIDS							Analyst: RBC
Total Dissolved Solids	3600	100	*D	mg/L	1	5/18/2023 3:45:00 PM	75000
SM 4500 NORG C: TKN							Analyst: RBC
Nitrogen, Kjeldahl, Total	ND	1.0		mg/L	1	5/19/2023 2:35:00 PM	75027

Refer to the QC Summary report and sample login checklist for flagged QC data and preservation information.

Qualifiers:	*	Value exceeds Maximum Contaminant Level.	B	Analyte detected in the associated Method Blank
	D	Sample Diluted Due to Matrix	E	Above Quantitation Range/Estimated Value
	H	Holding times for preparation or analysis exceeded	J	Analyte detected below quantitation limits
	ND	Not Detected at the Reporting Limit	P	Sample pH Not In Range
	PQL	Practical Quantitative Limit	RL	Reporting Limit
	S	% Recovery outside of standard limits. If undiluted results may be estimated.		

Hall Environmental Analysis Laboratory, Inc.

Analytical Report

Lab Order 2305763

Date Reported: 5/24/2023

CLIENT: EA Engineering

Client Sample ID: 624-01

Project: Dominguez Dairy 1

Collection Date: 5/12/2023 11:58:00 AM

Lab ID: 2305763-002

Matrix: GROUNDWA

Received Date: 5/15/2023 8:24:00 AM

Analyses	Result	RL	Qual	Units	DF	Date Analyzed	Batch
EPA METHOD 300.0: ANIONS							Analyst: NAI
Chloride	850	50	*	mg/L	100	5/15/2023 8:20:53 PM	R96779
Nitrate+Nitrite as N	12	1.0	*	mg/L	5	5/15/2023 9:51:01 PM	R96779
SM2540C MOD: TOTAL DISSOLVED SOLIDS							Analyst: RBC
Total Dissolved Solids	2680	100	*D	mg/L	1	5/18/2023 3:45:00 PM	75000
SM 4500 NORG C: TKN							Analyst: RBC
Nitrogen, Kjeldahl, Total	ND	2.0	D	mg/L	1	5/19/2023 2:35:00 PM	75027

Refer to the QC Summary report and sample login checklist for flagged QC data and preservation information.

Qualifiers:	*	Value exceeds Maximum Contaminant Level.	B	Analyte detected in the associated Method Blank
	D	Sample Diluted Due to Matrix	E	Above Quantitation Range/Estimated Value
	H	Holding times for preparation or analysis exceeded	J	Analyte detected below quantitation limits
	ND	Not Detected at the Reporting Limit	P	Sample pH Not In Range
	PQL	Practical Quantitative Limit	RL	Reporting Limit
	S	% Recovery outside of standard limits. If undiluted results may be estimated.		

Hall Environmental Analysis Laboratory, Inc.

Analytical Report

Lab Order 2305763

Date Reported: 5/24/2023

CLIENT: EA Engineering

Client Sample ID: 624-02

Project: Dominguez Dairy 1

Collection Date: 5/12/2023 1:45:00 PM

Lab ID: 2305763-003

Matrix: GROUNDWA

Received Date: 5/15/2023 8:24:00 AM

Analyses	Result	RL	Qual	Units	DF	Date Analyzed	Batch
EPA METHOD 300.0: ANIONS							Analyst: NAI
Chloride	690	50	*	mg/L	100	5/15/2023 8:46:36 PM	R96779
Nitrate+Nitrite as N	9.3	1.0		mg/L	5	5/15/2023 10:03:52 PM	R96779
SM2540C MOD: TOTAL DISSOLVED SOLIDS							Analyst: RBC
Total Dissolved Solids	2680	100	*D	mg/L	1	5/18/2023 3:45:00 PM	75000
SM 4500 NORG C: TKN							Analyst: RBC
Nitrogen, Kjeldahl, Total	ND	1.0		mg/L	1	5/19/2023 2:35:00 PM	75027

Refer to the QC Summary report and sample login checklist for flagged QC data and preservation information.

Qualifiers:	*	Value exceeds Maximum Contaminant Level.	B	Analyte detected in the associated Method Blank
	D	Sample Diluted Due to Matrix	E	Above Quantitation Range/Estimated Value
	H	Holding times for preparation or analysis exceeded	J	Analyte detected below quantitation limits
	ND	Not Detected at the Reporting Limit	P	Sample pH Not In Range
	PQL	Practical Quantitative Limit	RL	Reporting Limit
	S	% Recovery outside of standard limits. If undiluted results may be estimated.		

QC SUMMARY REPORT

Hall Environmental Analysis Laboratory, Inc.

WO#: 2305763

24-May-23

Client: EA Engineering
Project: Dominguez Dairy 1

Sample ID: MB	SampType: mblk	TestCode: EPA Method 300.0: Anions								
Client ID: PBW	Batch ID: R96779	RunNo: 96779								
Prep Date:	Analysis Date: 5/15/2023	SeqNo: 3510005			Units: mg/L					
Analyte	Result	PQL	SPK value	SPK Ref Val	%REC	LowLimit	HighLimit	%RPD	RPDLimit	Qual
Chloride	ND	0.50								
Nitrate+Nitrite as N	ND	0.20								

Sample ID: LCS	SampType: lcs	TestCode: EPA Method 300.0: Anions								
Client ID: LCSW	Batch ID: R96779	RunNo: 96779								
Prep Date:	Analysis Date: 5/15/2023	SeqNo: 3510006			Units: mg/L					
Analyte	Result	PQL	SPK value	SPK Ref Val	%REC	LowLimit	HighLimit	%RPD	RPDLimit	Qual
Chloride	4.7	0.50	5.000	0	93.6	90	110			
Nitrate+Nitrite as N	3.5	0.20	3.500	0	99.0	90	110			

Qualifiers:

- | | |
|---|---|
| * Value exceeds Maximum Contaminant Level. | B Analyte detected in the associated Method Blank |
| D Sample Diluted Due to Matrix | E Above Quantitation Range/Estimated Value |
| H Holding times for preparation or analysis exceeded | J Analyte detected below quantitation limits |
| ND Not Detected at the Reporting Limit | P Sample pH Not In Range |
| PQL Practical Quantitative Limit | RL Reporting Limit |
| S % Recovery outside of standard limits. If undiluted results may be estimated. | |

QC SUMMARY REPORT

Hall Environmental Analysis Laboratory, Inc.

WO#: 2305763

24-May-23

Client: EA Engineering
Project: Dominguez Dairy 1

Sample ID: MB-75000	SampType: MBLK	TestCode: SM2540C MOD: Total Dissolved Solids								
Client ID: PBW	Batch ID: 75000	RunNo: 96847								
Prep Date: 5/17/2023	Analysis Date: 5/18/2023	SeqNo: 3513126	Units: mg/L							
Analyte	Result	PQL	SPK value	SPK Ref Val	%REC	LowLimit	HighLimit	%RPD	RPDLimit	Qual
Total Dissolved Solids	ND	50.0								

Sample ID: LCS-75000	SampType: LCS	TestCode: SM2540C MOD: Total Dissolved Solids								
Client ID: LCSW	Batch ID: 75000	RunNo: 96847								
Prep Date: 5/17/2023	Analysis Date: 5/18/2023	SeqNo: 3513127	Units: mg/L							
Analyte	Result	PQL	SPK value	SPK Ref Val	%REC	LowLimit	HighLimit	%RPD	RPDLimit	Qual
Total Dissolved Solids	983	50.0	1000	0	98.3	80	120			

Qualifiers:

- * Value exceeds Maximum Contaminant Level.
- D Sample Diluted Due to Matrix
- H Holding times for preparation or analysis exceeded
- ND Not Detected at the Reporting Limit
- PQL Practical Quantitative Limit
- S % Recovery outside of standard limits. If undiluted results may be estimated.
- B Analyte detected in the associated Method Blank
- E Above Quantitation Range/Estimated Value
- J Analyte detected below quantitation limits
- P Sample pH Not In Range
- RL Reporting Limit

QC SUMMARY REPORT

Hall Environmental Analysis Laboratory, Inc.

WO#: 2305763

24-May-23

Client: EA Engineering
Project: Dominguez Dairy 1

Sample ID: MB-75027	SampType: MBLK	TestCode: SM 4500 Norg C: TKN								
Client ID: PBW	Batch ID: 75027	RunNo: 96905								
Prep Date: 5/18/2023	Analysis Date: 5/19/2023	SeqNo: 3515278	Units: mg/L							
Analyte	Result	PQL	SPK value	SPK Ref Val	%REC	LowLimit	HighLimit	%RPD	RPDLimit	Qual
Nitrogen, Kjeldahl, Total	ND	1.0								

Sample ID: LCS-75027	SampType: LCS	TestCode: SM 4500 Norg C: TKN								
Client ID: LCSW	Batch ID: 75027	RunNo: 96905								
Prep Date: 5/18/2023	Analysis Date: 5/19/2023	SeqNo: 3515279	Units: mg/L							
Analyte	Result	PQL	SPK value	SPK Ref Val	%REC	LowLimit	HighLimit	%RPD	RPDLimit	Qual
Nitrogen, Kjeldahl, Total	9.7	1.0	10.00	0	96.6	80	120			

Qualifiers:

- * Value exceeds Maximum Contaminant Level.
- D Sample Diluted Due to Matrix
- H Holding times for preparation or analysis exceeded
- ND Not Detected at the Reporting Limit
- PQL Practical Quantitative Limit
- S % Recovery outside of standard limits. If undiluted results may be estimated.
- B Analyte detected in the associated Method Blank
- E Above Quantitation Range/Estimated Value
- J Analyte detected below quantitation limits
- P Sample pH Not In Range
- RL Reporting Limit

Sample Log-In Check List

Client Name: EA Engineering

Work Order Number: 2305763

RcptNo: 1

Received By: Juan Rojas

5/15/2023 8:24:00 AM

Juan Rojas

Completed By: Cheyenne Cason

5/15/2023 10:43:13 AM

Cheyenne Cason

Reviewed By: *JA 5-12-23*

Chain of Custody

1. Is Chain of Custody complete? Yes No Not Present
2. How was the sample delivered? FedEx

Log In

3. Was an attempt made to cool the samples? Yes No NA
4. Were all samples received at a temperature of >0° C to 6.0°C Yes No NA
5. Sample(s) in proper container(s)? Yes No
6. Sufficient sample volume for indicated test(s)? Yes No
7. Are samples (except VOA and ONG) properly preserved? Yes No
8. Was preservative added to bottles? Yes No NA
9. Received at least 1 vial with headspace <1/4" for AQ VOA? Yes No NA
10. Were any sample containers received broken? Yes No
11. Does paperwork match bottle labels? Yes No
 (Note discrepancies on chain of custody)
12. Are matrices correctly identified on Chain of Custody? Yes No
13. Is it clear what analyses were requested? Yes No
14. Were all holding times able to be met? Yes No
 (If no, notify customer for authorization.)

of preserved bottles checked for pH: 3
 (<2 or >12 unless noted)
 Adjusted? NO
 Checked by: mc 5/15/23

Special Handling (if applicable)

15. Was client notified of all discrepancies with this order? Yes No NA

Person Notified:	Gina Mullen	Date:	5/15/2023
By Whom:	Cheyenne Cason	Via:	<input type="checkbox"/> eMail <input checked="" type="checkbox"/> Phone <input type="checkbox"/> Fax <input type="checkbox"/> In Person
Regarding:	LVM Samples recieved out of temp. continuing with run		
Client Instructions:			

16. Additional remarks:

17. Cooler Information

Cooler No	Temp °C	Condition	Seal Intact	Seal No	Seal Date	Signed By
1	7.5	Good	Not Present	Morty		

Chain-of-Custody Record

Client: EA Engineering, Science, and Technology
 Mailing Address: 320 Gold Ave SW Suite
 Phone #: 505-715-4279
 email or Fax#: rmullen@eaest.com

QA/QC Package: Standard Level 4 (Full Validation)
 Accreditation: Az Compliance NELAC Other
 EDD (Type)

Turn-Around Time: Standard Rush
 Project Name: Dominguez Dairy 1
 Project #:



HALL ENVIRONMENTAL ANALYSIS LABORATORY
 www.hallenvironmental.com
 4901 Hawkins NE - Albuquerque, NM 87109
 Tel. 505-345-3975 Fax 505-345-4107

Analysis Request

Project Manager: Gina Mullen
 Sampler: Angel N. Rivera
 On Ice: Yes No
 # of Coolers: 1
 Cooler Temp (including CF): 7.7 - 0.2 = 7.5°C

Analysis Request	Nitrate/Nitrites EPA Method 300	TKN SM 4500 NORG C	Chloride EPA 300	TDS SM 2540 C MOD	Sulfate EPA 300	Phosphorus EPA 6010B	Total Sulfur
	X	X	X	X			
	X	X	X	X			
	X	X	X	X			

Container Type and #	Preservative Type	HEAL No.
<u>2</u>		<u>2305763</u>
<u>2</u>		<u>001</u>
<u>2</u>		<u>002 002</u>
		<u>002 003</u>

Received by: UMP Via: FedEx Date: 5/15/23 Time: 8:24
 Received by: _____ Via: _____ Date: _____ Time: _____

Remarks:

If necessary, samples submitted to Hall Environmental may be subcontracted to other accredited laboratories. This serves as notice of this possibility. Any sub-contracted data will be clearly notated on the analytical report.



Hall Environmental Analysis Laboratory
4901 Hawkins NE
Albuquerque, NM 87109
TEL: 505-345-3975 FAX: 505-345-4107
Website: www.hallenvironmental.com

May 24, 2023

Regina Mullen
EA Engineering
320 Gold Ave SW Suite 1210
Albuquerque, NM 87102
TEL:
FAX:

RE: Big Sky Dairy

OrderNo.: 2305822

Dear Regina Mullen:

Hall Environmental Analysis Laboratory received 1 sample(s) on 5/16/2023 for the analyses presented in the following report.

These were analyzed according to EPA procedures or equivalent. To access our accredited tests please go to www.hallenvironmental.com or the state specific web sites. In order to properly interpret your results, it is imperative that you review this report in its entirety. See the sample checklist and/or the Chain of Custody for information regarding the sample receipt temperature and preservation. Data qualifiers or a narrative will be provided if the sample analysis or analytical quality control parameters require a flag. When necessary, data qualifiers are provided on both the sample analysis report and the QC summary report, both sections should be reviewed. All samples are reported, as received, unless otherwise indicated. Lab measurement of analytes considered field parameters that require analysis within 15 minutes of sampling such as pH and residual chlorine are qualified as being analyzed outside of the recommended holding time.

Please don't hesitate to contact HEAL for any additional information or clarifications.

ADHS Cert #AZ0682 -- NMED-DWB Cert #NM9425 -- NMED-Micro Cert #NM0901

Sincerely,

A handwritten signature in black ink, appearing to read 'Andy Freeman', is written in a cursive style.

Andy Freeman
Laboratory Manager
4901 Hawkins NE
Albuquerque, NM 87109

Hall Environmental Analysis Laboratory, Inc.

Analytical Report

Lab Order **2305822**

Date Reported: **5/24/2023**

CLIENT: EA Engineering

Client Sample ID: 833-06

Project: Big Sky Dairy

Collection Date: 5/15/2023 3:45:00 PM

Lab ID: 2305822-001

Matrix: GROUNDWA

Received Date: 5/16/2023 8:40:00 AM

Analyses	Result	RL	Qual	Units	DF	Date Analyzed	Batch
EPA METHOD 300.0: ANIONS							Analyst: JMT
Chloride	820	50	*	mg/L	100	5/16/2023 2:26:32 PM	R96810
Nitrogen, Nitrite (As N)	ND	1.0		mg/L	10	5/16/2023 1:47:57 PM	R96810
Nitrogen, Nitrate (As N)	44	1.0	*	mg/L	10	5/16/2023 1:47:57 PM	R96810
Sulfate	460	50	*	mg/L	100	5/16/2023 2:26:32 PM	R96810
SM2540C MOD: TOTAL DISSOLVED SOLIDS							Analyst: RBC
Total Dissolved Solids	2740	100	*D	mg/L	1	5/19/2023 4:32:00 PM	75024
SM 4500 NORG C: TKN							Analyst: DML
Nitrogen, Kjeldahl, Total	ND	5.0	D	mg/L	1	5/23/2023 10:19:00 AM	75062

Refer to the QC Summary report and sample login checklist for flagged QC data and preservation information.

Qualifiers:	*	Value exceeds Maximum Contaminant Level.	B	Analyte detected in the associated Method Blank
	D	Sample Diluted Due to Matrix	E	Above Quantitation Range/Estimated Value
	H	Holding times for preparation or analysis exceeded	J	Analyte detected below quantitation limits
	ND	Not Detected at the Reporting Limit	P	Sample pH Not In Range
	PQL	Practical Quantitative Limit	RL	Reporting Limit
	S	% Recovery outside of standard limits. If undiluted results may be estimated.		

QC SUMMARY REPORT

Hall Environmental Analysis Laboratory, Inc.

WO#: 2305822

24-May-23

Client: EA Engineering
Project: Big Sky Dairy

Sample ID: MB	SampType: mblk	TestCode: EPA Method 300.0: Anions								
Client ID: PBW	Batch ID: R96810	RunNo: 96810								
Prep Date:	Analysis Date: 5/16/2023	SeqNo: 3511424			Units: mg/L					
Analyte	Result	PQL	SPK value	SPK Ref Val	%REC	LowLimit	HighLimit	%RPD	RPDLimit	Qual
Chloride	ND	0.50								
Nitrogen, Nitrite (As N)	ND	0.10								
Nitrogen, Nitrate (As N)	ND	0.10								
Sulfate	ND	0.50								

Sample ID: LCS	SampType: lcs	TestCode: EPA Method 300.0: Anions								
Client ID: LCSW	Batch ID: R96810	RunNo: 96810								
Prep Date:	Analysis Date: 5/16/2023	SeqNo: 3511426			Units: mg/L					
Analyte	Result	PQL	SPK value	SPK Ref Val	%REC	LowLimit	HighLimit	%RPD	RPDLimit	Qual
Chloride	4.7	0.50	5.000	0	93.0	90	110			
Nitrogen, Nitrite (As N)	0.96	0.10	1.000	0	96.4	90	110			
Nitrogen, Nitrate (As N)	2.4	0.10	2.500	0	97.4	90	110			
Sulfate	9.5	0.50	10.00	0	94.7	90	110			

Sample ID: 2305822-001AMS	SampType: ms	TestCode: EPA Method 300.0: Anions								
Client ID: 833-06	Batch ID: R96810	RunNo: 96810								
Prep Date:	Analysis Date: 5/16/2023	SeqNo: 3511456			Units: mg/L					
Analyte	Result	PQL	SPK value	SPK Ref Val	%REC	LowLimit	HighLimit	%RPD	RPDLimit	Qual
Nitrogen, Nitrite (As N)	8.7	1.0	10.00	0	86.7	83	110			
Nitrogen, Nitrate (As N)	70	1.0	25.00	43.74	106	89.8	110			

Sample ID: 2305822-001AMSD	SampType: msd	TestCode: EPA Method 300.0: Anions								
Client ID: 833-06	Batch ID: R96810	RunNo: 96810								
Prep Date:	Analysis Date: 5/16/2023	SeqNo: 3511457			Units: mg/L					
Analyte	Result	PQL	SPK value	SPK Ref Val	%REC	LowLimit	HighLimit	%RPD	RPDLimit	Qual
Nitrogen, Nitrite (As N)	8.7	1.0	10.00	0	86.8	81	110	0.104	20	
Nitrogen, Nitrate (As N)	69	1.0	25.00	43.74	99.4	87.7	111	2.40	20	

Qualifiers:

* Value exceeds Maximum Contaminant Level.
 D Sample Diluted Due to Matrix
 H Holding times for preparation or analysis exceeded
 ND Not Detected at the Reporting Limit
 PQL Practical Quantitative Limit
 S % Recovery outside of standard limits. If undiluted results may be estimated.

B Analyte detected in the associated Method Blank
 E Above Quantitation Range/Estimated Value
 J Analyte detected below quantitation limits
 P Sample pH Not In Range
 RL Reporting Limit

QC SUMMARY REPORT

Hall Environmental Analysis Laboratory, Inc.

WO#: 2305822

24-May-23

Client: EA Engineering
Project: Big Sky Dairy

Sample ID: MB-75024	SampType: MBLK	TestCode: SM2540C MOD: Total Dissolved Solids								
Client ID: PBW	Batch ID: 75024	RunNo: 96884								
Prep Date: 5/18/2023	Analysis Date: 5/19/2023	SeqNo: 3514645	Units: mg/L							
Analyte	Result	PQL	SPK value	SPK Ref Val	%REC	LowLimit	HighLimit	%RPD	RPDLimit	Qual
Total Dissolved Solids	ND	50.0								

Sample ID: LCS-75024	SampType: LCS	TestCode: SM2540C MOD: Total Dissolved Solids								
Client ID: LCSW	Batch ID: 75024	RunNo: 96884								
Prep Date: 5/18/2023	Analysis Date: 5/19/2023	SeqNo: 3514646	Units: mg/L							
Analyte	Result	PQL	SPK value	SPK Ref Val	%REC	LowLimit	HighLimit	%RPD	RPDLimit	Qual
Total Dissolved Solids	980	50.0	1000	0	98.0	80	120			

Qualifiers:

- | | |
|---|---|
| * Value exceeds Maximum Contaminant Level. | B Analyte detected in the associated Method Blank |
| D Sample Diluted Due to Matrix | E Above Quantitation Range/Estimated Value |
| H Holding times for preparation or analysis exceeded | J Analyte detected below quantitation limits |
| ND Not Detected at the Reporting Limit | P Sample pH Not In Range |
| PQL Practical Quantitative Limit | RL Reporting Limit |
| S % Recovery outside of standard limits. If undiluted results may be estimated. | |

QC SUMMARY REPORT

Hall Environmental Analysis Laboratory, Inc.

WO#: 2305822

24-May-23

Client: EA Engineering
Project: Big Sky Dairy

Sample ID: MB-75062	SampType: MBLK	TestCode: SM 4500 Norg C: TKN								
Client ID: PBW	Batch ID: 75062	RunNo: 96948								
Prep Date: 5/19/2023	Analysis Date: 5/23/2023	SeqNo: 3517393	Units: mg/L							
Analyte	Result	PQL	SPK value	SPK Ref Val	%REC	LowLimit	HighLimit	%RPD	RPDLimit	Qual
Nitrogen, Kjeldahl, Total	ND	1.0								

Sample ID: LCS-75062	SampType: LCS	TestCode: SM 4500 Norg C: TKN								
Client ID: LCSW	Batch ID: 75062	RunNo: 96948								
Prep Date: 5/19/2023	Analysis Date: 5/23/2023	SeqNo: 3517394	Units: mg/L							
Analyte	Result	PQL	SPK value	SPK Ref Val	%REC	LowLimit	HighLimit	%RPD	RPDLimit	Qual
Nitrogen, Kjeldahl, Total	10	1.0	10.00	0	101	80	120			

Qualifiers:

- * Value exceeds Maximum Contaminant Level.
- D Sample Diluted Due to Matrix
- H Holding times for preparation or analysis exceeded
- ND Not Detected at the Reporting Limit
- PQL Practical Quantitative Limit
- S % Recovery outside of standard limits. If undiluted results may be estimated.
- B Analyte detected in the associated Method Blank
- E Above Quantitation Range/Estimated Value
- J Analyte detected below quantitation limits
- P Sample pH Not In Range
- RL Reporting Limit

Sample Log-In Check List

Client Name: EA Engineering

Work Order Number: 2305822

RcptNo: 1

Received By: Juan Rojas

5/16/2023 8:40:00 AM

Juan Rojas

Completed By: Tracy Casarrubias

5/16/2023 9:36:47 AM

Reviewed By: *Jn 5/16/23*

Chain of Custody

1. Is Chain of Custody complete? Yes No Not Present
2. How was the sample delivered? FedEx

Log In

3. Was an attempt made to cool the samples? Yes No NA
4. Were all samples received at a temperature of >0° C to 6.0°C Yes No NA
5. Sample(s) in proper container(s)? Yes No
6. Sufficient sample volume for indicated test(s)? Yes No
7. Are samples (except VOA and ONG) properly preserved? Yes No
8. Was preservative added to bottles? Yes No NA
9. Received at least 1 vial with headspace <1/4" for AQ VOA? Yes No NA
10. Were any sample containers received broken? Yes No
11. Does paperwork match bottle labels?
 (Note discrepancies on chain of custody) Yes No
12. Are matrices correctly identified on Chain of Custody? Yes No
13. Is it clear what analyses were requested? Yes No
14. Were all holding times able to be met?
 (If no, notify customer for authorization.) Yes No

of preserved bottles checked for pH: 1
 (<2 or >12 unless noted)
 Adjusted? No
 Checked by: *WA 5/16/23*

Special Handling (if applicable)

15. Was client notified of all discrepancies with this order? Yes No NA

Person Notified: _____ Date: _____
 By Whom: _____ Via: eMail Phone Fax In Person
 Regarding: _____
 Client Instructions: _____

16. Additional remarks:

17. Cooler Information

Cooler No	Temp °C	Condition	Seal Intact	Seal No	Seal Date	Signed By
1	0.1	Good	Not Present	Yogi		



Hall Environmental Analysis Laboratory
4901 Hawkins NE
Albuquerque, NM 87109
TEL: 505-345-3975 FAX: 505-345-4107
Website: www.hallenvironmental.com

May 24, 2023

Regina Mullen
EA Engineering
320 Gold Ave SW Suite 1210
Albuquerque, NM 87102
TEL:
FAX:

RE: Buena Vista Dairy 2

OrderNo.: 2305823

Dear Regina Mullen:

Hall Environmental Analysis Laboratory received 3 sample(s) on 5/16/2023 for the analyses presented in the following report.

These were analyzed according to EPA procedures or equivalent. To access our accredited tests please go to www.hallenvironmental.com or the state specific web sites. In order to properly interpret your results, it is imperative that you review this report in its entirety. See the sample checklist and/or the Chain of Custody for information regarding the sample receipt temperature and preservation. Data qualifiers or a narrative will be provided if the sample analysis or analytical quality control parameters require a flag. When necessary, data qualifiers are provided on both the sample analysis report and the QC summary report, both sections should be reviewed. All samples are reported, as received, unless otherwise indicated. Lab measurement of analytes considered field parameters that require analysis within 15 minutes of sampling such as pH and residual chlorine are qualified as being analyzed outside of the recommended holding time.

Please don't hesitate to contact HEAL for any additional information or clarifications.

ADHS Cert #AZ0682 -- NMED-DWB Cert #NM9425 -- NMED-Micro Cert #NM0901

Sincerely,

A handwritten signature in black ink, appearing to read 'Andy Freeman', is written in a cursive style.

Andy Freeman
Laboratory Manager
4901 Hawkins NE
Albuquerque, NM 87109

Hall Environmental Analysis Laboratory, Inc.

Analytical Report

Lab Order 2305823

Date Reported: 5/24/2023

CLIENT: EA Engineering

Client Sample ID: 74-01

Project: Buena Vista Dairy 2

Collection Date: 5/15/2023 10:52:00 AM

Lab ID: 2305823-001

Matrix: GROUNDWA

Received Date: 5/16/2023 8:40:00 AM

Analyses	Result	RL	Qual	Units	DF	Date Analyzed	Batch
EPA METHOD 300.0: ANIONS							Analyst: JMT
Chloride	770	50	*	mg/L	100	5/16/2023 2:25:11 PM	R96805
Nitrogen, Nitrite (As N)	ND	1.0		mg/L	10	5/16/2023 1:46:35 PM	R96805
Nitrogen, Nitrate (As N)	43	1.0	*	mg/L	10	5/16/2023 1:46:35 PM	R96805
SM2540C MOD: TOTAL DISSOLVED SOLIDS							Analyst: RBC
Total Dissolved Solids	2950	50.0	*	mg/L	1	5/19/2023 4:32:00 PM	75024
SM 4500 NORG C: TKN							Analyst: DML
Nitrogen, Kjeldahl, Total	ND	5.0	D	mg/L	1	5/23/2023 10:19:00 AM	75062

Refer to the QC Summary report and sample login checklist for flagged QC data and preservation information.

Qualifiers:	*	Value exceeds Maximum Contaminant Level.	B	Analyte detected in the associated Method Blank
	D	Sample Diluted Due to Matrix	E	Above Quantitation Range/Estimated Value
	H	Holding times for preparation or analysis exceeded	J	Analyte detected below quantitation limits
	ND	Not Detected at the Reporting Limit	P	Sample pH Not In Range
	PQL	Practical Quantitative Limit	RL	Reporting Limit
	S	% Recovery outside of standard limits. If undiluted results may be estimated.		

Hall Environmental Analysis Laboratory, Inc.

Analytical Report

Lab Order **2305823**

Date Reported: **5/24/2023**

CLIENT: EA Engineering

Client Sample ID: 74-04

Project: Buena Vista Dairy 2

Collection Date: 5/15/2023 12:30:00 PM

Lab ID: 2305823-002

Matrix: GROUNDWA

Received Date: 5/16/2023 8:40:00 AM

Analyses	Result	RL	Qual	Units	DF	Date Analyzed	Batch
EPA METHOD 300.0: ANIONS							Analyst: JMT
Chloride	460	50	*	mg/L	100	5/16/2023 2:50:55 PM	R96805
Nitrogen, Nitrite (As N)	ND	1.0		mg/L	10	5/16/2023 2:38:04 PM	R96805
Nitrogen, Nitrate (As N)	12	1.0	*	mg/L	10	5/16/2023 2:38:04 PM	R96805
SM2540C MOD: TOTAL DISSOLVED SOLIDS							Analyst: RBC
Total Dissolved Solids	1830	100	*D	mg/L	1	5/19/2023 4:32:00 PM	75024
SM 4500 NORG C: TKN							Analyst: DML
Nitrogen, Kjeldahl, Total	ND	2.0	D	mg/L	1	5/23/2023 10:19:00 AM	75062

Refer to the QC Summary report and sample login checklist for flagged QC data and preservation information.

Qualifiers:	*	Value exceeds Maximum Contaminant Level.	B	Analyte detected in the associated Method Blank
	D	Sample Diluted Due to Matrix	E	Above Quantitation Range/Estimated Value
	H	Holding times for preparation or analysis exceeded	J	Analyte detected below quantitation limits
	ND	Not Detected at the Reporting Limit	P	Sample pH Not In Range
	PQL	Practical Quantitative Limit	RL	Reporting Limit
	S	% Recovery outside of standard limits. If undiluted results may be estimated.		

Hall Environmental Analysis Laboratory, Inc.

Analytical Report

Lab Order **2305823**

Date Reported: **5/24/2023**

CLIENT: EA Engineering

Client Sample ID: 74-05

Project: Buena Vista Dairy 2

Collection Date: 5/15/2023 2:47:00 PM

Lab ID: 2305823-003

Matrix: GROUNDWA

Received Date: 5/16/2023 8:40:00 AM

Analyses	Result	RL	Qual	Units	DF	Date Analyzed	Batch
EPA METHOD 300.0: ANIONS							Analyst: JMT
Chloride	600	50	*	mg/L	100	5/16/2023 3:16:39 PM	R96805
Nitrogen, Nitrite (As N)	ND	1.0		mg/L	10	5/16/2023 3:03:47 PM	R96805
Nitrogen, Nitrate (As N)	20	1.0	*	mg/L	10	5/16/2023 3:03:47 PM	R96805
SM2540C MOD: TOTAL DISSOLVED SOLIDS							Analyst: RBC
Total Dissolved Solids	2170	100	*D	mg/L	1	5/19/2023 4:32:00 PM	75024
SM 4500 NORG C: TKN							Analyst: DML
Nitrogen, Kjeldahl, Total	ND	5.0	D	mg/L	1	5/23/2023 10:19:00 AM	75062

Refer to the QC Summary report and sample login checklist for flagged QC data and preservation information.

Qualifiers:	*	Value exceeds Maximum Contaminant Level.	B	Analyte detected in the associated Method Blank
	D	Sample Diluted Due to Matrix	E	Above Quantitation Range/Estimated Value
	H	Holding times for preparation or analysis exceeded	J	Analyte detected below quantitation limits
	ND	Not Detected at the Reporting Limit	P	Sample pH Not In Range
	PQL	Practical Quantitative Limit	RL	Reporting Limit
	S	% Recovery outside of standard limits. If undiluted results may be estimated.		

QC SUMMARY REPORT

Hall Environmental Analysis Laboratory, Inc.

WO#: 2305823

24-May-23

Client: EA Engineering
Project: Buena Vista Dairy 2

Sample ID: MB	SampType: mblk	TestCode: EPA Method 300.0: Anions								
Client ID: PBW	Batch ID: R96805	RunNo: 96805								
Prep Date:	Analysis Date: 5/16/2023	SeqNo: 3511103	Units: mg/L							
Analyte	Result	PQL	SPK value	SPK Ref Val	%REC	LowLimit	HighLimit	%RPD	RPDLimit	Qual

Chloride	ND	0.50								
Nitrogen, Nitrite (As N)	ND	0.10								
Nitrogen, Nitrate (As N)	ND	0.10								

Sample ID: LCS	SampType: lcs	TestCode: EPA Method 300.0: Anions								
Client ID: LCSW	Batch ID: R96805	RunNo: 96805								
Prep Date:	Analysis Date: 5/16/2023	SeqNo: 3511104	Units: mg/L							
Analyte	Result	PQL	SPK value	SPK Ref Val	%REC	LowLimit	HighLimit	%RPD	RPDLimit	Qual

Chloride	4.7	0.50	5.000	0	93.3	90	110			
Nitrogen, Nitrite (As N)	0.96	0.10	1.000	0	95.8	90	110			
Nitrogen, Nitrate (As N)	2.5	0.10	2.500	0	99.6	90	110			

Sample ID: 2305823-001AMS	SampType: ms	TestCode: EPA Method 300.0: Anions								
Client ID: 74-01	Batch ID: R96805	RunNo: 96805								
Prep Date:	Analysis Date: 5/16/2023	SeqNo: 3511128	Units: mg/L							
Analyte	Result	PQL	SPK value	SPK Ref Val	%REC	LowLimit	HighLimit	%RPD	RPDLimit	Qual

Nitrogen, Nitrite (As N)	9.5	1.0	10.00	0	94.9	83	110			
Nitrogen, Nitrate (As N)	68	1.0	25.00	42.85	102	89.8	110			

Sample ID: 2305823-001AMSD	SampType: msd	TestCode: EPA Method 300.0: Anions								
Client ID: 74-01	Batch ID: R96805	RunNo: 96805								
Prep Date:	Analysis Date: 5/16/2023	SeqNo: 3511129	Units: mg/L							
Analyte	Result	PQL	SPK value	SPK Ref Val	%REC	LowLimit	HighLimit	%RPD	RPDLimit	Qual

Nitrogen, Nitrite (As N)	9.5	1.0	10.00	0	94.8	81	110	0.0844	20	
Nitrogen, Nitrate (As N)	68	1.0	25.00	42.85	100	87.7	111	0.611	20	

Qualifiers:

- * Value exceeds Maximum Contaminant Level.
- D Sample Diluted Due to Matrix
- H Holding times for preparation or analysis exceeded
- ND Not Detected at the Reporting Limit
- PQL Practical Quantitative Limit
- S % Recovery outside of standard limits. If undiluted results may be estimated.
- B Analyte detected in the associated Method Blank
- E Above Quantitation Range/Estimated Value
- J Analyte detected below quantitation limits
- P Sample pH Not In Range
- RL Reporting Limit

QC SUMMARY REPORT

Hall Environmental Analysis Laboratory, Inc.

WO#: 2305823

24-May-23

Client: EA Engineering
Project: Buena Vista Dairy 2

Sample ID: MB-75024	SampType: MBLK	TestCode: SM2540C MOD: Total Dissolved Solids								
Client ID: PBW	Batch ID: 75024	RunNo: 96884								
Prep Date: 5/18/2023	Analysis Date: 5/19/2023	SeqNo: 3514645	Units: mg/L							
Analyte	Result	PQL	SPK value	SPK Ref Val	%REC	LowLimit	HighLimit	%RPD	RPDLimit	Qual
Total Dissolved Solids	ND	50.0								

Sample ID: LCS-75024	SampType: LCS	TestCode: SM2540C MOD: Total Dissolved Solids								
Client ID: LCSW	Batch ID: 75024	RunNo: 96884								
Prep Date: 5/18/2023	Analysis Date: 5/19/2023	SeqNo: 3514646	Units: mg/L							
Analyte	Result	PQL	SPK value	SPK Ref Val	%REC	LowLimit	HighLimit	%RPD	RPDLimit	Qual
Total Dissolved Solids	980	50.0	1000	0	98.0	80	120			

Qualifiers:

- * Value exceeds Maximum Contaminant Level.
- D Sample Diluted Due to Matrix
- H Holding times for preparation or analysis exceeded
- ND Not Detected at the Reporting Limit
- PQL Practical Quantitative Limit
- S % Recovery outside of standard limits. If undiluted results may be estimated.
- B Analyte detected in the associated Method Blank
- E Above Quantitation Range/Estimated Value
- J Analyte detected below quantitation limits
- P Sample pH Not In Range
- RL Reporting Limit

QC SUMMARY REPORT

Hall Environmental Analysis Laboratory, Inc.

WO#: 2305823

24-May-23

Client: EA Engineering
Project: Buena Vista Dairy 2

Sample ID: MB-75062	SampType: MBLK	TestCode: SM 4500 Norg C: TKN								
Client ID: PBW	Batch ID: 75062	RunNo: 96948								
Prep Date: 5/19/2023	Analysis Date: 5/23/2023	SeqNo: 3517393	Units: mg/L							
Analyte	Result	PQL	SPK value	SPK Ref Val	%REC	LowLimit	HighLimit	%RPD	RPDLimit	Qual
Nitrogen, Kjeldahl, Total	ND	1.0								

Sample ID: LCS-75062	SampType: LCS	TestCode: SM 4500 Norg C: TKN								
Client ID: LCSW	Batch ID: 75062	RunNo: 96948								
Prep Date: 5/19/2023	Analysis Date: 5/23/2023	SeqNo: 3517394	Units: mg/L							
Analyte	Result	PQL	SPK value	SPK Ref Val	%REC	LowLimit	HighLimit	%RPD	RPDLimit	Qual
Nitrogen, Kjeldahl, Total	10	1.0	10.00	0	101	80	120			

Qualifiers:

- * Value exceeds Maximum Contaminant Level.
- D Sample Diluted Due to Matrix
- H Holding times for preparation or analysis exceeded
- ND Not Detected at the Reporting Limit
- PQL Practical Quantitative Limit
- S % Recovery outside of standard limits. If undiluted results may be estimated.
- B Analyte detected in the associated Method Blank
- E Above Quantitation Range/Estimated Value
- J Analyte detected below quantitation limits
- P Sample pH Not In Range
- RL Reporting Limit

Sample Log-In Check List

Client Name: EA Engineering

Work Order Number: 2305823

RcptNo: 1

Received By: Juan Rojas 5/16/2023 8:40:00 AM *Juan Rojas*

Completed By: Tracy Casarrubias 5/16/2023 9:54:47 AM

Reviewed By: *TC 5/16/23*

Chain of Custody

1. Is Chain of Custody complete? Yes No Not Present
2. How was the sample delivered? FedEx

Log In

3. Was an attempt made to cool the samples? Yes No NA
4. Were all samples received at a temperature of >0° C to 6.0°C Yes No NA
5. Sample(s) in proper container(s)? Yes No
6. Sufficient sample volume for indicated test(s)? Yes No
7. Are samples (except VOA and ONG) properly preserved? Yes No
8. Was preservative added to bottles? Yes No NA
9. Received at least 1 vial with headspace <1/4" for AQ VOA? Yes No NA
10. Were any sample containers received broken? Yes No
11. Does paperwork match bottle labels? Yes No
 (Note discrepancies on chain of custody)
12. Are matrices correctly identified on Chain of Custody? Yes No
13. Is it clear what analyses were requested? Yes No
14. Were all holding times able to be met? Yes No
 (If no, notify customer for authorization.)

of preserved bottles checked for pH: 3
 (2 or >12 unless noted)
 Adjusted? No
 Checked by: *TC 5/16/23*

Special Handling (if applicable)

15. Was client notified of all discrepancies with this order? Yes No NA

Person Notified:	<input type="text"/>	Date:	<input type="text"/>
By Whom:	<input type="text"/>	Via:	<input type="checkbox"/> eMail <input type="checkbox"/> Phone <input type="checkbox"/> Fax <input type="checkbox"/> In Person
Regarding:	<input type="text"/>		
Client Instructions:	<input type="text"/>		

16. Additional remarks:

17. Cooler Information

Cooler No	Temp °C	Condition	Seal Intact	Seal No	Seal Date	Signed By
1	0.1	Good	Not Present	Yogi		

Chain-of-Custody Record



Client:  EA Engineering, Science, and Technology
 Mailing Address: 320 Gold Ave SW Suite
 Phone #: 505-715-4279
 email or Fax#: rmullen@eaest.com

QA/QC Package:
 Standard Level 4 (Full Validation)
 Accreditation: Az Compliance
 NELAC Other
 EDD (Type) _____

Project Name: Buena Vista Dairy 2
 Project #: _____
 Project Manager: Gina Mullen
 Sampler: Angel N. Rivera
 On Ice: Yes No
 # of Coolers: 400
 Cooler Temp (including CF): 0.0701 - 0.1

Date	Time	Matrix	Sample Name	Container Type and #	Preservative Type	HEAL No.
5-15	10:58	Gw	74-01	2		2300823
5-15	12:30	Gw	7404	2		001
5-15	14:47	Gw	7405	2		002
						003

Turn-Around Time: Standard Rush
 Project Name: Buena Vista Dairy 2
 Project #: _____
 Project Manager: Gina Mullen
 Sampler: Angel N. Rivera
 On Ice: Yes No
 # of Coolers: 400
 Cooler Temp (including CF): 0.0701 - 0.1

Received by:  Date: 5/16/23 Time: 8:40
 Relinquished by:  Date: 5/16/23 Time: 8:40
 Relinquished by: _____ Date: _____ Time: _____



HALL ENVIRONMENTAL ANALYSIS LABORATORY
 www.hallenvironmental.com
 4901 Hawkins NE - Albuquerque, NM 87109
 Tel. 505-345-3975 Fax 505-345-4107

Analysis Request	
Nitrate/Nitrites EPA Method 300	X
TKN SM 4500 NORG C	X
Chloride EPA 300	X
TDS SM 2540 C MOD	X
Sulfate EPA 300	X
Phosphorus EPA 6010B	
Total Sulfur	

Remarks:

If necessary, samples submitted to Hall Environmental may be subcontracted to other accredited laboratories. This serves as notice of this possibility. Any sub-contracted data will be clearly notated on the analytical report.



Hall Environmental Analysis Laboratory
4901 Hawkins NE
Albuquerque, NM 87109
TEL: 505-345-3975 FAX: 505-345-4107
Website: www.hallenvironmental.com

May 24, 2023

Regina Mullen
EA Engineering
320 Gold Ave SW Suite 1210
Albuquerque, NM 87102
TEL:
FAX:

RE: Big Sky Dairy

OrderNo.: 2305884

Dear Regina Mullen:

Hall Environmental Analysis Laboratory received 4 sample(s) on 5/17/2023 for the analyses presented in the following report.

These were analyzed according to EPA procedures or equivalent. To access our accredited tests please go to www.hallenvironmental.com or the state specific web sites. In order to properly interpret your results, it is imperative that you review this report in its entirety. See the sample checklist and/or the Chain of Custody for information regarding the sample receipt temperature and preservation. Data qualifiers or a narrative will be provided if the sample analysis or analytical quality control parameters require a flag. When necessary, data qualifiers are provided on both the sample analysis report and the QC summary report, both sections should be reviewed. All samples are reported, as received, unless otherwise indicated. Lab measurement of analytes considered field parameters that require analysis within 15 minutes of sampling such as pH and residual chlorine are qualified as being analyzed outside of the recommended holding time.

Please don't hesitate to contact HEAL for any additional information or clarifications.

ADHS Cert #AZ0682 -- NMED-DWB Cert #NM9425 -- NMED-Micro Cert #NM0901

Sincerely,

A handwritten signature in black ink, appearing to read 'Andy Freeman', is written in a cursive style.

Andy Freeman
Laboratory Manager
4901 Hawkins NE
Albuquerque, NM 87109

Hall Environmental Analysis Laboratory, Inc.

Analytical Report

Lab Order 2305884

Date Reported: 5/24/2023

CLIENT: EA Engineering

Client Sample ID: 833-04

Project: Big Sky Dairy

Collection Date: 5/16/2023 10:36:00 AM

Lab ID: 2305884-001

Matrix: GROUNDWA

Received Date: 5/17/2023 8:45:00 AM

Analyses	Result	RL	Qual	Units	DF	Date Analyzed	Batch
EPA METHOD 300.0: ANIONS							Analyst: NAI
Chloride	790	50	*	mg/L	100	5/17/2023 1:12:06 PM	R96843
Nitrogen, Nitrite (As N)	ND	1.0		mg/L	10	5/17/2023 12:34:53 PM	R96843
Nitrogen, Nitrate (As N)	29	1.0	*	mg/L	10	5/17/2023 12:34:53 PM	R96843
Sulfate	460	50	*	mg/L	100	5/17/2023 1:12:06 PM	R96843
SM2540C MOD: TOTAL DISSOLVED SOLIDS							Analyst: RBC
Total Dissolved Solids	2650	100	*D	mg/L	1	5/22/2023 3:39:00 PM	75053
SM 4500 NORG C: TKN							Analyst: DML
Nitrogen, Kjeldahl, Total	ND	5.0	D	mg/L	1	5/23/2023 10:19:00 AM	75062

Refer to the QC Summary report and sample login checklist for flagged QC data and preservation information.

Qualifiers:	*	Value exceeds Maximum Contaminant Level.	B	Analyte detected in the associated Method Blank
	D	Sample Diluted Due to Matrix	E	Above Quantitation Range/Estimated Value
	H	Holding times for preparation or analysis exceeded	J	Analyte detected below quantitation limits
	ND	Not Detected at the Reporting Limit	P	Sample pH Not In Range
	PQL	Practical Quantitative Limit	RL	Reporting Limit
	S	% Recovery outside of standard limits. If undiluted results may be estimated.		

Hall Environmental Analysis Laboratory, Inc.

Analytical Report

Lab Order 2305884

Date Reported: 5/24/2023

CLIENT: EA Engineering

Client Sample ID: 833-02

Project: Big Sky Dairy

Collection Date: 5/16/2023 12:39:00 PM

Lab ID: 2305884-002

Matrix: GROUNDWA

Received Date: 5/17/2023 8:45:00 AM

Analyses	Result	RL	Qual	Units	DF	Date Analyzed	Batch
EPA METHOD 300.0: ANIONS							Analyst: NAI
Chloride	1300	50	*	mg/L	100	5/17/2023 1:36:54 PM	R96843
Nitrogen, Nitrite (As N)	ND	1.0		mg/L	10	5/17/2023 1:24:30 PM	R96843
Nitrogen, Nitrate (As N)	37	1.0	*	mg/L	10	5/17/2023 1:24:30 PM	R96843
Sulfate	660	50	*	mg/L	100	5/17/2023 1:36:54 PM	R96843
SM2540C MOD: TOTAL DISSOLVED SOLIDS							Analyst: RBC
Total Dissolved Solids	3760	100	*D	mg/L	1	5/22/2023 3:39:00 PM	75053
SM 4500 NORG C: TKN							Analyst: RBC
Nitrogen, Kjeldahl, Total	ND	5.0	D	mg/L	1	5/23/2023 2:13:00 PM	75102

Refer to the QC Summary report and sample login checklist for flagged QC data and preservation information.

Qualifiers:	*	Value exceeds Maximum Contaminant Level.	B	Analyte detected in the associated Method Blank
	D	Sample Diluted Due to Matrix	E	Above Quantitation Range/Estimated Value
	H	Holding times for preparation or analysis exceeded	J	Analyte detected below quantitation limits
	ND	Not Detected at the Reporting Limit	P	Sample pH Not In Range
	PQL	Practical Quantitative Limit	RL	Reporting Limit
	S	% Recovery outside of standard limits. If undiluted results may be estimated.		

Hall Environmental Analysis Laboratory, Inc.

Analytical Report

Lab Order 2305884

Date Reported: 5/24/2023

CLIENT: EA Engineering

Client Sample ID: 833-08

Project: Big Sky Dairy

Collection Date: 5/16/2023 2:27:00 PM

Lab ID: 2305884-003

Matrix: GROUNDWA

Received Date: 5/17/2023 8:45:00 AM

Analyses	Result	RL	Qual	Units	DF	Date Analyzed	Batch
EPA METHOD 300.0: ANIONS							Analyst: NAI
Chloride	1100	50	*	mg/L	100	5/17/2023 2:26:33 PM	R96843
Nitrogen, Nitrite (As N)	ND	1.0		mg/L	10	5/17/2023 2:14:08 PM	R96843
Nitrogen, Nitrate (As N)	49	1.0	*	mg/L	10	5/17/2023 2:14:08 PM	R96843
Sulfate	460	50	*	mg/L	100	5/17/2023 2:26:33 PM	R96843
SM2540C MOD: TOTAL DISSOLVED SOLIDS							Analyst: RBC
Total Dissolved Solids	3210	100	*D	mg/L	1	5/22/2023 3:39:00 PM	75053
SM 4500 NORG C: TKN							Analyst: DML
Nitrogen, Kjeldahl, Total	ND	5.0	D	mg/L	1	5/23/2023 1:53:00 PM	75103

Refer to the QC Summary report and sample login checklist for flagged QC data and preservation information.

Qualifiers:	*	Value exceeds Maximum Contaminant Level.	B	Analyte detected in the associated Method Blank
	D	Sample Diluted Due to Matrix	E	Above Quantitation Range/Estimated Value
	H	Holding times for preparation or analysis exceeded	J	Analyte detected below quantitation limits
	ND	Not Detected at the Reporting Limit	P	Sample pH Not In Range
	PQL	Practical Quantitative Limit	RL	Reporting Limit
	S	% Recovery outside of standard limits. If undiluted results may be estimated.		

Hall Environmental Analysis Laboratory, Inc.

Analytical Report

Lab Order 2305884

Date Reported: 5/24/2023

CLIENT: EA Engineering

Client Sample ID: 833-07

Project: Big Sky Dairy

Collection Date: 5/16/2023 3:50:00 PM

Lab ID: 2305884-004

Matrix: GROUNDWA

Received Date: 5/17/2023 8:45:00 AM

Analyses	Result	RL	Qual	Units	DF	Date Analyzed	Batch
EPA METHOD 300.0: ANIONS							Analyst: NAI
Chloride	1300	50	*	mg/L	100	5/17/2023 2:51:22 PM	R96843
Nitrogen, Nitrite (As N)	ND	1.0		mg/L	10	5/17/2023 2:38:57 PM	R96843
Nitrogen, Nitrate (As N)	92	10	*	mg/L	100	5/17/2023 2:51:22 PM	R96843
Sulfate	730	50	*	mg/L	100	5/17/2023 2:51:22 PM	R96843
SM2540C MOD: TOTAL DISSOLVED SOLIDS							Analyst: RBC
Total Dissolved Solids	4450	100	*D	mg/L	1	5/22/2023 3:39:00 PM	75053
SM 4500 NORG C: TKN							Analyst: RBC
Nitrogen, Kjeldahl, Total	ND	5.0	D	mg/L	1	5/23/2023 2:13:00 PM	75102

Refer to the QC Summary report and sample login checklist for flagged QC data and preservation information.

Qualifiers:	*	Value exceeds Maximum Contaminant Level.	B	Analyte detected in the associated Method Blank
	D	Sample Diluted Due to Matrix	E	Above Quantitation Range/Estimated Value
	H	Holding times for preparation or analysis exceeded	J	Analyte detected below quantitation limits
	ND	Not Detected at the Reporting Limit	P	Sample pH Not In Range
	PQL	Practical Quantitative Limit	RL	Reporting Limit
	S	% Recovery outside of standard limits. If undiluted results may be estimated.		

QC SUMMARY REPORT

Hall Environmental Analysis Laboratory, Inc.

WO#: 2305884

24-May-23

Client: EA Engineering
Project: Big Sky Dairy

Sample ID: MB	SampType: mblk	TestCode: EPA Method 300.0: Anions								
Client ID: PBW	Batch ID: R96843	RunNo: 96843								
Prep Date:	Analysis Date: 5/17/2023	SeqNo: 3512756	Units: mg/L							
Analyte	Result	PQL	SPK value	SPK Ref Val	%REC	LowLimit	HighLimit	%RPD	RPDLimit	Qual
Chloride	ND	0.50								
Nitrogen, Nitrite (As N)	ND	0.10								
Nitrogen, Nitrate (As N)	ND	0.10								
Sulfate	ND	0.50								

Sample ID: LCS	SampType: lcs	TestCode: EPA Method 300.0: Anions								
Client ID: LCSW	Batch ID: R96843	RunNo: 96843								
Prep Date:	Analysis Date: 5/17/2023	SeqNo: 3512757	Units: mg/L							
Analyte	Result	PQL	SPK value	SPK Ref Val	%REC	LowLimit	HighLimit	%RPD	RPDLimit	Qual
Chloride	4.7	0.50	5.000	0	93.2	90	110			
Nitrogen, Nitrite (As N)	0.95	0.10	1.000	0	94.5	90	110			
Nitrogen, Nitrate (As N)	2.5	0.10	2.500	0	98.8	90	110			
Sulfate	9.6	0.50	10.00	0	95.6	90	110			

Sample ID: 2305884-001AMS	SampType: ms	TestCode: EPA Method 300.0: Anions								
Client ID: 833-04	Batch ID: R96843	RunNo: 96843								
Prep Date:	Analysis Date: 5/17/2023	SeqNo: 3512759	Units: mg/L							
Analyte	Result	PQL	SPK value	SPK Ref Val	%REC	LowLimit	HighLimit	%RPD	RPDLimit	Qual
Nitrogen, Nitrite (As N)	8.5	1.0	10.00	0	84.9	83	110			
Nitrogen, Nitrate (As N)	55	1.0	25.00	29.40	102	89.8	110			

Sample ID: 2305884-001AMSD	SampType: msd	TestCode: EPA Method 300.0: Anions								
Client ID: 833-04	Batch ID: R96843	RunNo: 96843								
Prep Date:	Analysis Date: 5/17/2023	SeqNo: 3512760	Units: mg/L							
Analyte	Result	PQL	SPK value	SPK Ref Val	%REC	LowLimit	HighLimit	%RPD	RPDLimit	Qual
Nitrogen, Nitrite (As N)	8.5	1.0	10.00	0	84.8	81	110	0.0471	20	
Nitrogen, Nitrate (As N)	55	1.0	25.00	29.40	102	87.7	111	0.353	20	

Qualifiers:

- * Value exceeds Maximum Contaminant Level.
- D Sample Diluted Due to Matrix
- H Holding times for preparation or analysis exceeded
- ND Not Detected at the Reporting Limit
- PQL Practical Quantitative Limit
- S % Recovery outside of standard limits. If undiluted results may be estimated.
- B Analyte detected in the associated Method Blank
- E Above Quantitation Range/Estimated Value
- J Analyte detected below quantitation limits
- P Sample pH Not In Range
- RL Reporting Limit

QC SUMMARY REPORT

Hall Environmental Analysis Laboratory, Inc.

WO#: 2305884

24-May-23

Client: EA Engineering

Project: Big Sky Dairy

Sample ID: MB-75053	SampType: MBLK	TestCode: SM2540C MOD: Total Dissolved Solids								
Client ID: PBW	Batch ID: 75053	RunNo: 96930								
Prep Date: 5/19/2023	Analysis Date: 5/22/2023	SeqNo: 3516464			Units: mg/L					
Analyte	Result	PQL	SPK value	SPK Ref Val	%REC	LowLimit	HighLimit	%RPD	RPDLimit	Qual
Total Dissolved Solids	ND	50.0								

Sample ID: LCS-75053	SampType: LCS	TestCode: SM2540C MOD: Total Dissolved Solids								
Client ID: LCSW	Batch ID: 75053	RunNo: 96930								
Prep Date: 5/19/2023	Analysis Date: 5/22/2023	SeqNo: 3516465			Units: mg/L					
Analyte	Result	PQL	SPK value	SPK Ref Val	%REC	LowLimit	HighLimit	%RPD	RPDLimit	Qual
Total Dissolved Solids	977	50.0	1000	0	97.7	80	120			

Qualifiers:

* Value exceeds Maximum Contaminant Level.
D Sample Diluted Due to Matrix
H Holding times for preparation or analysis exceeded
ND Not Detected at the Reporting Limit
PQL Practical Quantitative Limit
S % Recovery outside of standard limits. If undiluted results may be estimated.

B Analyte detected in the associated Method Blank
E Above Quantitation Range/Estimated Value
J Analyte detected below quantitation limits
P Sample pH Not In Range
RL Reporting Limit

QC SUMMARY REPORT

Hall Environmental Analysis Laboratory, Inc.

WO#: 2305884

24-May-23

Client: EA Engineering
Project: Big Sky Dairy

Sample ID: MB-75062	SampType: MBLK	TestCode: SM 4500 Norg C: TKN								
Client ID: PBW	Batch ID: 75062	RunNo: 96948								
Prep Date: 5/19/2023	Analysis Date: 5/23/2023	SeqNo: 3517393	Units: mg/L							
Analyte	Result	PQL	SPK value	SPK Ref Val	%REC	LowLimit	HighLimit	%RPD	RPDLimit	Qual
Nitrogen, Kjeldahl, Total	ND	1.0								

Sample ID: LCS-75062	SampType: LCS	TestCode: SM 4500 Norg C: TKN								
Client ID: LCSW	Batch ID: 75062	RunNo: 96948								
Prep Date: 5/19/2023	Analysis Date: 5/23/2023	SeqNo: 3517394	Units: mg/L							
Analyte	Result	PQL	SPK value	SPK Ref Val	%REC	LowLimit	HighLimit	%RPD	RPDLimit	Qual
Nitrogen, Kjeldahl, Total	10	1.0	10.00	0	101	80	120			

Sample ID: MB-75103	SampType: MBLK	TestCode: SM 4500 Norg C: TKN								
Client ID: PBW	Batch ID: 75103	RunNo: 96957								
Prep Date: 5/22/2023	Analysis Date: 5/23/2023	SeqNo: 3517680	Units: mg/L							
Analyte	Result	PQL	SPK value	SPK Ref Val	%REC	LowLimit	HighLimit	%RPD	RPDLimit	Qual
Nitrogen, Kjeldahl, Total	ND	1.0								

Sample ID: LCS-75103	SampType: LCS	TestCode: SM 4500 Norg C: TKN								
Client ID: LCSW	Batch ID: 75103	RunNo: 96957								
Prep Date: 5/22/2023	Analysis Date: 5/23/2023	SeqNo: 3517681	Units: mg/L							
Analyte	Result	PQL	SPK value	SPK Ref Val	%REC	LowLimit	HighLimit	%RPD	RPDLimit	Qual
Nitrogen, Kjeldahl, Total	9.8	1.0	10.00	0	98.0	80	120			

Sample ID: MB-75102	SampType: MBLK	TestCode: SM 4500 Norg C: TKN								
Client ID: PBW	Batch ID: 75102	RunNo: 96958								
Prep Date: 5/22/2023	Analysis Date: 5/23/2023	SeqNo: 3517700	Units: mg/L							
Analyte	Result	PQL	SPK value	SPK Ref Val	%REC	LowLimit	HighLimit	%RPD	RPDLimit	Qual
Nitrogen, Kjeldahl, Total	ND	1.0								

Sample ID: LCS-75102	SampType: LCS	TestCode: SM 4500 Norg C: TKN								
Client ID: LCSW	Batch ID: 75102	RunNo: 96958								
Prep Date: 5/22/2023	Analysis Date: 5/23/2023	SeqNo: 3517701	Units: mg/L							
Analyte	Result	PQL	SPK value	SPK Ref Val	%REC	LowLimit	HighLimit	%RPD	RPDLimit	Qual
Nitrogen, Kjeldahl, Total	9.8	1.0	10.00	0	98.0	80	120			

Qualifiers:

- * Value exceeds Maximum Contaminant Level.
- D Sample Diluted Due to Matrix
- H Holding times for preparation or analysis exceeded
- ND Not Detected at the Reporting Limit
- PQL Practical Quantitative Limit
- S % Recovery outside of standard limits. If undiluted results may be estimated.
- B Analyte detected in the associated Method Blank
- E Above Quantitation Range/Estimated Value
- J Analyte detected below quantitation limits
- P Sample pH Not In Range
- RL Reporting Limit

Sample Log-In Check List

Client Name: EA Engineering

Work Order Number: 2305884

RcptNo: 1

Received By: Desiree Dominguez 5/17/2023 8:45:00 AM

Completed By: Desiree Dominguez 5/17/2023 9:38:17 AM

Reviewed By: *UD 5/17/23*

DD

DD

Chain of Custody

1. Is Chain of Custody complete? Yes No Not Present
2. How was the sample delivered? FedEx

Log In

3. Was an attempt made to cool the samples? Yes No NA
4. Were all samples received at a temperature of >0° C to 6.0°C Yes No NA
5. Sample(s) in proper container(s)? Yes No
6. Sufficient sample volume for indicated test(s)? Yes No
7. Are samples (except VOA and ONG) properly preserved? Yes No
8. Was preservative added to bottles? Yes No NA
9. Received at least 1 vial with headspace <1/4" for AQ VOA? Yes No NA
10. Were any sample containers received broken? Yes No
11. Does paperwork match bottle labels? Yes No
 (Note discrepancies on chain of custody)
12. Are matrices correctly identified on Chain of Custody? Yes No
13. Is it clear what analyses were requested? Yes No
14. Were all holding times able to be met? Yes No
 (If no, notify customer for authorization.)

of preserved bottles checked for pH: 4
 (<2 or >12 unless noted)
 Adjusted? NO
 Checked by: ms 5/17/23
ph strip lot# 538534

Special Handling (if applicable)

15. Was client notified of all discrepancies with this order? Yes No NA

Person Notified:	<input type="text"/>	Date:	<input type="text"/>
By Whom:	<input type="text"/>	Via:	<input type="checkbox"/> eMail <input type="checkbox"/> Phone <input type="checkbox"/> Fax <input type="checkbox"/> In Person
Regarding:	<input type="text"/>		
Client Instructions:	<input type="text"/>		

16. Additional remarks:

17. Cooler Information

Cooler No	Temp °C	Condition	Seal Intact	Seal No	Seal Date	Signed By
1	2.3	Good	Not Present	Morty		



Hall Environmental Analysis Laboratory
4901 Hawkins NE
Albuquerque, NM 87109
TEL: 505-345-3975 FAX: 505-345-4107
Website: www.hallenvironmental.com

May 24, 2023

Regina Mullen
EA Engineering
320 Gold Ave SW Suite 1210
Albuquerque, NM 87102
TEL:
FAX:

RE: Big Sky Dairy

OrderNo.: 2305977

Dear Regina Mullen:

Hall Environmental Analysis Laboratory received 2 sample(s) on 5/18/2023 for the analyses presented in the following report.

These were analyzed according to EPA procedures or equivalent. To access our accredited tests please go to www.hallenvironmental.com or the state specific web sites. In order to properly interpret your results, it is imperative that you review this report in its entirety. See the sample checklist and/or the Chain of Custody for information regarding the sample receipt temperature and preservation. Data qualifiers or a narrative will be provided if the sample analysis or analytical quality control parameters require a flag. When necessary, data qualifiers are provided on both the sample analysis report and the QC summary report, both sections should be reviewed. All samples are reported, as received, unless otherwise indicated. Lab measurement of analytes considered field parameters that require analysis within 15 minutes of sampling such as pH and residual chlorine are qualified as being analyzed outside of the recommended holding time.

Please don't hesitate to contact HEAL for any additional information or clarifications.

ADHS Cert #AZ0682 -- NMED-DWB Cert #NM9425 -- NMED-Micro Cert #NM0901

Sincerely,

A handwritten signature in black ink, appearing to read 'Andy Freeman', is written in a cursive style.

Andy Freeman
Laboratory Manager
4901 Hawkins NE
Albuquerque, NM 87109

Hall Environmental Analysis Laboratory, Inc.

Analytical Report

Lab Order 2305977

Date Reported: 5/24/2023

CLIENT: EA Engineering

Client Sample ID: 833-09

Project: Big Sky Dairy

Collection Date: 5/17/2023 10:21:00 AM

Lab ID: 2305977-001

Matrix: GROUNDWA

Received Date: 5/18/2023 8:45:00 AM

Analyses	Result	RL	Qual	Units	DF	Date Analyzed	Batch
EPA METHOD 300.0: ANIONS							Analyst: CAS
Chloride	850	50	*	mg/L	100	5/18/2023 3:12:37 PM	R96872
Nitrogen, Nitrite (As N)	ND	1.0		mg/L	10	5/18/2023 2:59:46 PM	R96872
Nitrogen, Nitrate (As N)	110	10	*	mg/L	100	5/18/2023 3:12:37 PM	R96872
Sulfate	750	50	*	mg/L	100	5/18/2023 3:12:37 PM	R96872
SM2540C MOD: TOTAL DISSOLVED SOLIDS							Analyst: RBC
Total Dissolved Solids	4100	250	*D	mg/L	1	5/23/2023 4:12:00 PM	75081
SM 4500 NORG C: TKN							Analyst: RBC
Nitrogen, Kjeldahl, Total	ND	5.0	D	mg/L	1	5/24/2023 9:19:00 AM	75112

Refer to the QC Summary report and sample login checklist for flagged QC data and preservation information.

Qualifiers:	*	Value exceeds Maximum Contaminant Level.	B	Analyte detected in the associated Method Blank
	D	Sample Diluted Due to Matrix	E	Above Quantitation Range/Estimated Value
	H	Holding times for preparation or analysis exceeded	J	Analyte detected below quantitation limits
	ND	Not Detected at the Reporting Limit	P	Sample pH Not In Range
	PQL	Practical Quantitative Limit	RL	Reporting Limit
	S	% Recovery outside of standard limits. If undiluted results may be estimated.		

Hall Environmental Analysis Laboratory, Inc.

Analytical Report

Lab Order 2305977

Date Reported: 5/24/2023

CLIENT: EA Engineering

Client Sample ID: 833-10

Project: Big Sky Dairy

Collection Date: 5/17/2023 12:20:00 PM

Lab ID: 2305977-002

Matrix: GROUNDWA

Received Date: 5/18/2023 8:45:00 AM

Analyses	Result	RL	Qual	Units	DF	Date Analyzed	Batch
EPA METHOD 300.0: ANIONS							Analyst: CAS
Chloride	700	50	*	mg/L	100	5/18/2023 3:38:21 PM	R96872
Nitrogen, Nitrite (As N)	ND	1.0		mg/L	10	5/18/2023 3:25:29 PM	R96872
Nitrogen, Nitrate (As N)	2.2	1.0		mg/L	10	5/18/2023 3:25:29 PM	R96872
Sulfate	450	50	*	mg/L	100	5/18/2023 3:38:21 PM	R96872
SM2540C MOD: TOTAL DISSOLVED SOLIDS							Analyst: RBC
Total Dissolved Solids	2790	50.0	*	mg/L	1	5/23/2023 4:12:00 PM	75081
SM 4500 NORG C: TKN							Analyst: RBC
Nitrogen, Kjeldahl, Total	ND	1.0		mg/L	1	5/24/2023 9:19:00 AM	75112

Refer to the QC Summary report and sample login checklist for flagged QC data and preservation information.

Qualifiers:	*	Value exceeds Maximum Contaminant Level.	B	Analyte detected in the associated Method Blank
	D	Sample Diluted Due to Matrix	E	Above Quantitation Range/Estimated Value
	H	Holding times for preparation or analysis exceeded	J	Analyte detected below quantitation limits
	ND	Not Detected at the Reporting Limit	P	Sample pH Not In Range
	PQL	Practical Quantitative Limit	RL	Reporting Limit
	S	% Recovery outside of standard limits. If undiluted results may be estimated.		

QC SUMMARY REPORT

Hall Environmental Analysis Laboratory, Inc.

WO#: 2305977

24-May-23

Client: EA Engineering
Project: Big Sky Dairy

Sample ID: MB	SampType: mblk	TestCode: EPA Method 300.0: Anions
Client ID: PBW	Batch ID: R96872	RunNo: 96872
Prep Date:	Analysis Date: 5/18/2023	SeqNo: 3514086 Units: mg/L

Analyte	Result	PQL	SPK value	SPK Ref Val	%REC	LowLimit	HighLimit	%RPD	RPDLimit	Qual
Chloride	ND	0.50								
Nitrogen, Nitrite (As N)	ND	0.10								
Nitrogen, Nitrate (As N)	ND	0.10								
Sulfate	ND	0.50								

Sample ID: LCS	SampType: ics	TestCode: EPA Method 300.0: Anions
Client ID: LCSW	Batch ID: R96872	RunNo: 96872
Prep Date:	Analysis Date: 5/18/2023	SeqNo: 3514087 Units: mg/L

Analyte	Result	PQL	SPK value	SPK Ref Val	%REC	LowLimit	HighLimit	%RPD	RPDLimit	Qual
Chloride	4.8	0.50	5.000	0	96.5	90	110			
Nitrogen, Nitrite (As N)	0.99	0.10	1.000	0	98.6	90	110			
Nitrogen, Nitrate (As N)	2.6	0.10	2.500	0	103	90	110			
Sulfate	9.8	0.50	10.00	0	98.4	90	110			

Qualifiers:

- * Value exceeds Maximum Contaminant Level.
- D Sample Diluted Due to Matrix
- H Holding times for preparation or analysis exceeded
- ND Not Detected at the Reporting Limit
- PQL Practical Quantitative Limit
- S % Recovery outside of standard limits. If undiluted results may be estimated.
- B Analyte detected in the associated Method Blank
- E Above Quantitation Range/Estimated Value
- J Analyte detected below quantitation limits
- P Sample pH Not In Range
- RL Reporting Limit

QC SUMMARY REPORT

Hall Environmental Analysis Laboratory, Inc.

WO#: 2305977

24-May-23

Client: EA Engineering

Project: Big Sky Dairy

Sample ID: MB-75081	SampType: MBLK	TestCode: SM2540C MOD: Total Dissolved Solids								
Client ID: PBW	Batch ID: 75081	RunNo: 96956								
Prep Date: 5/22/2023	Analysis Date: 5/23/2023	SeqNo: 3517656			Units: mg/L					
Analyte	Result	PQL	SPK value	SPK Ref Val	%REC	LowLimit	HighLimit	%RPD	RPDLimit	Qual
Total Dissolved Solids	ND	50.0								

Sample ID: LCS-75081	SampType: LCS	TestCode: SM2540C MOD: Total Dissolved Solids								
Client ID: LCSW	Batch ID: 75081	RunNo: 96956								
Prep Date: 5/22/2023	Analysis Date: 5/23/2023	SeqNo: 3517657			Units: mg/L					
Analyte	Result	PQL	SPK value	SPK Ref Val	%REC	LowLimit	HighLimit	%RPD	RPDLimit	Qual
Total Dissolved Solids	992	50.0	1000	0	99.2	80	120			

Qualifiers:

*	Value exceeds Maximum Contaminant Level.	B	Analyte detected in the associated Method Blank
D	Sample Diluted Due to Matrix	E	Above Quantitation Range/Estimated Value
H	Holding times for preparation or analysis exceeded	J	Analyte detected below quantitation limits
ND	Not Detected at the Reporting Limit	P	Sample pH Not In Range
PQL	Practical Quantitative Limit	RL	Reporting Limit
S	% Recovery outside of standard limits. If undiluted results may be estimated.		

QC SUMMARY REPORT

Hall Environmental Analysis Laboratory, Inc.

WO#: 2305977

24-May-23

Client: EA Engineering

Project: Big Sky Dairy

Sample ID: MB-75112	SampType: MBLK	TestCode: SM 4500 Norg C: TKN								
Client ID: PBW	Batch ID: 75112	RunNo: 96978								
Prep Date: 5/22/2023	Analysis Date: 5/24/2023	SeqNo: 3518576 Units: mg/L								
Analyte	Result	PQL	SPK value	SPK Ref Val	%REC	LowLimit	HighLimit	%RPD	RPDLimit	Qual
Nitrogen, Kjeldahl, Total	ND	1.0								

Sample ID: LCS-75112	SampType: LCS	TestCode: SM 4500 Norg C: TKN								
Client ID: LCSW	Batch ID: 75112	RunNo: 96978								
Prep Date: 5/22/2023	Analysis Date: 5/24/2023	SeqNo: 3518577 Units: mg/L								
Analyte	Result	PQL	SPK value	SPK Ref Val	%REC	LowLimit	HighLimit	%RPD	RPDLimit	Qual
Nitrogen, Kjeldahl, Total	9.9	1.0	10.00	0	99.4	80	120			

Qualifiers:

* Value exceeds Maximum Contaminant Level.
D Sample Diluted Due to Matrix
H Holding times for preparation or analysis exceeded
ND Not Detected at the Reporting Limit
PQL Practical Quantitative Limit
S % Recovery outside of standard limits. If undiluted results may be estimated.

B Analyte detected in the associated Method Blank
E Above Quantitation Range/Estimated Value
J Analyte detected below quantitation limits
P Sample pH Not In Range
RL Reporting Limit

Sample Log-In Check List

Client Name: EA Engineering

Work Order Number: 2305977

RcptNo: 1

Received By: Juan Rojas

5/18/2023 8:45:00 AM

Juan Rojas

Completed By: Tracy Casarrubias

5/18/2023 10:27:12 AM

Reviewed By: *ms 5/18/23*

Chain of Custody

1. Is Chain of Custody complete? Yes No Not Present
 2. How was the sample delivered? FedEx

Log In

3. Was an attempt made to cool the samples? Yes No NA
 4. Were all samples received at a temperature of >0° C to 6.0°C Yes No NA
 5. Sample(s) in proper container(s)? Yes No
 6. Sufficient sample volume for indicated test(s)? Yes No
 7. Are samples (except VOA and ONG) properly preserved? Yes No
 8. Was preservative added to bottles? Yes No NA
 9. Received at least 1 vial with headspace <1/4" for AQ VOA? Yes No NA
 10. Were any sample containers received broken? Yes No
 11. Does paperwork match bottle labels? Yes No
 (Note discrepancies on chain of custody)
 12. Are matrices correctly identified on Chain of Custody? Yes No
 13. Is it clear what analyses were requested? Yes No
 14. Were all holding times able to be met? Yes No
 (If no, notify customer for authorization.)

Ph Lot # 538334
of preserved bottles checked for pH: 2
(<2 or >12 unless noted)
 Adjusted? *no*
 Checked by: *CMC 5/18/23*

Special Handling (if applicable)

15. Was client notified of all discrepancies with this order? Yes No NA

Person Notified: _____ Date: _____
 By Whom: _____ Via: eMail Phone Fax In Person
 Regarding: _____
 Client Instructions: _____

16. Additional remarks:

Cooler Information

Cooler No	Temp °C	Condition	Seal Intact	Seal No	Seal Date	Signed By
1	1.0	Good	Not Present	Yogi		



Hall Environmental Analysis Laboratory
4901 Hawkins NE
Albuquerque, NM 87109
TEL: 505-345-3975 FAX: 505-345-4107
Website: www.hallenvironmental.com

May 24, 2023

Regina Mullen
EA Engineering
320 Gold Ave SW Suite 1210
Albuquerque, NM 87102
TEL:
FAX:

RE: Sunset Dairy

OrderNo.: 2305979

Dear Regina Mullen:

Hall Environmental Analysis Laboratory received 1 sample(s) on 5/18/2023 for the analyses presented in the following report.

These were analyzed according to EPA procedures or equivalent. To access our accredited tests please go to www.hallenvironmental.com or the state specific web sites. In order to properly interpret your results, it is imperative that you review this report in its entirety. See the sample checklist and/or the Chain of Custody for information regarding the sample receipt temperature and preservation. Data qualifiers or a narrative will be provided if the sample analysis or analytical quality control parameters require a flag. When necessary, data qualifiers are provided on both the sample analysis report and the QC summary report, both sections should be reviewed. All samples are reported, as received, unless otherwise indicated. Lab measurement of analytes considered field parameters that require analysis within 15 minutes of sampling such as pH and residual chlorine are qualified as being analyzed outside of the recommended holding time.

Please don't hesitate to contact HEAL for any additional information or clarifications.

ADHS Cert #AZ0682 -- NMED-DWB Cert #NM9425 -- NMED-Micro Cert #NM0901

Sincerely,

A handwritten signature in black ink, appearing to read "Andy Freeman", is written in a cursive style.

Andy Freeman
Laboratory Manager
4901 Hawkins NE
Albuquerque, NM 87109

Hall Environmental Analysis Laboratory, Inc.

Analytical Report

Lab Order 2305979

Date Reported: 5/24/2023

CLIENT: EA Engineering

Client Sample ID: 257-01

Project: Sunset Dairy

Collection Date: 5/17/2023 3:15:00 PM

Lab ID: 2305979-001

Matrix: GROUNDWA

Received Date: 5/18/2023 8:45:00 AM

Analyses	Result	RL	Qual	Units	DF	Date Analyzed	Batch
EPA METHOD 300.0: ANIONS							Analyst: CAS
Chloride	860	50	*	mg/L	100	5/18/2023 2:21:11 PM	R96872
Nitrogen, Nitrite (As N)	ND	1.0		mg/L	10	5/18/2023 2:08:18 PM	R96872
Nitrogen, Nitrate (As N)	31	1.0	*	mg/L	10	5/18/2023 2:08:18 PM	R96872
Sulfate	630	50	*	mg/L	100	5/18/2023 2:21:11 PM	R96872
SM2540C MOD: TOTAL DISSOLVED SOLIDS							Analyst: RBC
Total Dissolved Solids	3610	250	*D	mg/L	1	5/23/2023 4:12:00 PM	75081
SM 4500 NORG C: TKN							Analyst: RBC
Nitrogen, Kjeldahl, Total	ND	5.0	D	mg/L	1	5/24/2023 9:19:00 AM	75112

Refer to the QC Summary report and sample login checklist for flagged QC data and preservation information.

Qualifiers:	*	Value exceeds Maximum Contaminant Level.	B	Analyte detected in the associated Method Blank
	D	Sample Diluted Due to Matrix	E	Above Quantitation Range/Estimated Value
	H	Holding times for preparation or analysis exceeded	J	Analyte detected below quantitation limits
	ND	Not Detected at the Reporting Limit	P	Sample pH Not In Range
	PQL	Practical Quantitative Limit	RL	Reporting Limit
	S	% Recovery outside of standard limits. If undiluted results may be estimated.		

QC SUMMARY REPORT

Hall Environmental Analysis Laboratory, Inc.

WO#: 2305979

24-May-23

Client: EA Engineering

Project: Sunset Dairy

Sample ID: MB	SampType: mblk	TestCode: EPA Method 300.0: Anions								
Client ID: PBW	Batch ID: R96872	RunNo: 96872								
Prep Date:	Analysis Date: 5/18/2023	SeqNo: 3514086	Units: mg/L							
Analyte	Result	PQL	SPK value	SPK Ref Val	%REC	LowLimit	HighLimit	%RPD	RPDLimit	Qual

Chloride	ND	0.50								
Nitrogen, Nitrite (As N)	ND	0.10								
Nitrogen, Nitrate (As N)	ND	0.10								
Sulfate	ND	0.50								

Sample ID: LCS	SampType: ics	TestCode: EPA Method 300.0: Anions								
Client ID: LCSW	Batch ID: R96872	RunNo: 96872								
Prep Date:	Analysis Date: 5/18/2023	SeqNo: 3514087	Units: mg/L							
Analyte	Result	PQL	SPK value	SPK Ref Val	%REC	LowLimit	HighLimit	%RPD	RPDLimit	Qual

Chloride	4.8	0.50	5.000	0	96.5	90	110			
Nitrogen, Nitrite (As N)	0.99	0.10	1.000	0	98.6	90	110			
Nitrogen, Nitrate (As N)	2.6	0.10	2.500	0	103	90	110			
Sulfate	9.8	0.50	10.00	0	98.4	90	110			

Qualifiers:

- * Value exceeds Maximum Contaminant Level.
- D Sample Diluted Due to Matrix
- H Holding times for preparation or analysis exceeded
- ND Not Detected at the Reporting Limit
- PQL Practical Quantitative Limit
- S % Recovery outside of standard limits. If undiluted results may be estimated.
- B Analyte detected in the associated Method Blank
- E Above Quantitation Range/Estimated Value
- J Analyte detected below quantitation limits
- P Sample pH Not In Range
- RL Reporting Limit

QC SUMMARY REPORT

Hall Environmental Analysis Laboratory, Inc.

WO#: 2305979

24-May-23

Client: EA Engineering

Project: Sunset Dairy

Sample ID: MB-75081	SampType: MBLK	TestCode: SM2540C MOD: Total Dissolved Solids								
Client ID: PBW	Batch ID: 75081	RunNo: 96956								
Prep Date: 5/22/2023	Analysis Date: 5/23/2023	SeqNo: 3517656	Units: mg/L							
Analyte	Result	PQL	SPK value	SPK Ref Val	%REC	LowLimit	HighLimit	%RPD	RPDLimit	Qual
Total Dissolved Solids	ND	50.0								

Sample ID: LCS-75081	SampType: LCS	TestCode: SM2540C MOD: Total Dissolved Solids								
Client ID: LCSW	Batch ID: 75081	RunNo: 96956								
Prep Date: 5/22/2023	Analysis Date: 5/23/2023	SeqNo: 3517657	Units: mg/L							
Analyte	Result	PQL	SPK value	SPK Ref Val	%REC	LowLimit	HighLimit	%RPD	RPDLimit	Qual
Total Dissolved Solids	992	50.0	1000	0	99.2	80	120			

Qualifiers:

- | | |
|---|---|
| * Value exceeds Maximum Contaminant Level. | B Analyte detected in the associated Method Blank |
| D Sample Diluted Due to Matrix | E Above Quantitation Range/Estimated Value |
| H Holding times for preparation or analysis exceeded | J Analyte detected below quantitation limits |
| ND Not Detected at the Reporting Limit | P Sample pH Not In Range |
| PQL Practical Quantitative Limit | RL Reporting Limit |
| S % Recovery outside of standard limits. If undiluted results may be estimated. | |

QC SUMMARY REPORT

Hall Environmental Analysis Laboratory, Inc.

WO#: 2305979

24-May-23

Client: EA Engineering
Project: Sunset Dairy

Sample ID: MB-75112	SampType: MBLK	TestCode: SM 4500 Norg C: TKN								
Client ID: PBW	Batch ID: 75112	RunNo: 96978								
Prep Date: 5/22/2023	Analysis Date: 5/24/2023	SeqNo: 3518576	Units: mg/L							
Analyte	Result	PQL	SPK value	SPK Ref Val	%REC	LowLimit	HighLimit	%RPD	RPDLimit	Qual
Nitrogen, Kjeldahl, Total	ND	1.0								

Sample ID: LCS-75112	SampType: LCS	TestCode: SM 4500 Norg C: TKN								
Client ID: LCSW	Batch ID: 75112	RunNo: 96978								
Prep Date: 5/22/2023	Analysis Date: 5/24/2023	SeqNo: 3518577	Units: mg/L							
Analyte	Result	PQL	SPK value	SPK Ref Val	%REC	LowLimit	HighLimit	%RPD	RPDLimit	Qual
Nitrogen, Kjeldahl, Total	9.9	1.0	10.00	0	99.4	80	120			

Qualifiers:

- | | |
|---|---|
| * Value exceeds Maximum Contaminant Level. | B Analyte detected in the associated Method Blank |
| D Sample Diluted Due to Matrix | E Above Quantitation Range/Estimated Value |
| H Holding times for preparation or analysis exceeded | J Analyte detected below quantitation limits |
| ND Not Detected at the Reporting Limit | P Sample pH Not In Range |
| PQL Practical Quantitative Limit | RL Reporting Limit |
| S % Recovery outside of standard limits. If undiluted results may be estimated. | |

Sample Log-In Check List

Client Name: EA Engineering

Work Order Number: 2305979

RcptNo: 1

Received By: Juan Rojas

5/18/2023 8:45:00 AM



Completed By: Tracy Casarrubias

5/18/2023 10:31:12 AM

Reviewed By: *ms/18/23*

Chain of Custody

1. Is Chain of Custody complete? Yes No Not Present
2. How was the sample delivered? FedEx

Log In

3. Was an attempt made to cool the samples? Yes No NA
4. Were all samples received at a temperature of >0° C to 6.0°C Yes No NA
5. Sample(s) in proper container(s)? Yes No
6. Sufficient sample volume for indicated test(s)? Yes No
7. Are samples (except VOA and ONG) properly preserved? Yes No
8. Was preservative added to bottles? Yes No NA
9. Received at least 1 vial with headspace <1/4" for AQ VOA? Yes No NA
10. Were any sample containers received broken? Yes No
11. Does paperwork match bottle labels?
(Note discrepancies on chain of custody) Yes No
12. Are matrices correctly identified on Chain of Custody? Yes No
13. Is it clear what analyses were requested? Yes No
14. Were all holding times able to be met?
(If no, notify customer for authorization.) Yes No

Ph lot # 538534

of preserved bottles checked for pH: 1
(<2 or >12 unless noted)

Adjusted? NO

Checked by: CMC 5/18/23

Special Handling (if applicable)

15. Was client notified of all discrepancies with this order? Yes No NA

Person Notified: _____ Date: _____

By Whom: _____ Via: eMail Phone Fax In Person

Regarding: _____

Client Instructions: _____

16. Additional remarks:

17. Cooler Information

Cooler No	Temp °C	Condition	Seal Intact	Seal No	Seal Date	Signed By
1	1.0	Good	Not Present	Yogi		

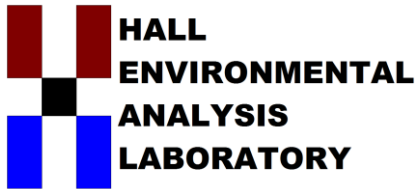

Hall Environmental Analysis Laboratory
4901 Hawkins NE
Albuquerque, NM 87109
TEL: 505-345-3975 FAX: 505-345-4107
Website: www.hallenvironmental.com

June 21, 2023

Regina Mullen
EA Engineering
320 Gold Ave SW Suite 1210
Albuquerque, NM 87102
TEL:
FAX:

RE: Dona Ana Dairies

OrderNo.: 2306078

Dear Regina Mullen:

Hall Environmental Analysis Laboratory received 4 sample(s) on 6/2/2023 for the analyses presented in the following report.

These were analyzed according to EPA procedures or equivalent. To access our accredited tests please go to www.hallenvironmental.com or the state specific web sites. In order to properly interpret your results, it is imperative that you review this report in its entirety. See the sample checklist and/or the Chain of Custody for information regarding the sample receipt temperature and preservation. Data qualifiers or a narrative will be provided if the sample analysis or analytical quality control parameters require a flag. When necessary, data qualifiers are provided on both the sample analysis report and the QC summary report, both sections should be reviewed. All samples are reported, as received, unless otherwise indicated. Lab measurement of analytes considered field parameters that require analysis within 15 minutes of sampling such as pH and residual chlorine are qualified as being analyzed outside of the recommended holding time.

Please don't hesitate to contact HEAL for any additional information or clarifications.

ADHS Cert #AZ0682 -- NMED-DWB Cert #NM9425 -- NMED-Micro Cert #NM0901

Sincerely,

A handwritten signature in black ink, appearing to read 'Andy Freeman', is written in a cursive style.

Andy Freeman
Laboratory Manager
4901 Hawkins NE
Albuquerque, NM 87109

Hall Environmental Analysis Laboratory, Inc.

Analytical Report

Lab Order 2306078

Date Reported: 6/21/2023

CLIENT: EA Engineering

Client Sample ID: DAD-24

Project: Dona Ana Dairies

Collection Date: 6/1/2023 10:56:00 AM

Lab ID: 2306078-001

Matrix: GROUNDWA

Received Date: 6/2/2023 8:50:00 AM

Analyses	Result	RL	Qual	Units	DF	Date Analyzed
EPA METHOD 300.0: ANIONS						Analyst: JTT
Chloride	990	50	*	mg/L	100	6/2/2023 12:47:10 PM
Nitrogen, Nitrite (As N)	ND	1.0		mg/L	10	6/2/2023 12:08:33 PM
Nitrogen, Nitrate (As N)	6.0	1.0		mg/L	10	6/2/2023 12:08:33 PM
SM2540C MOD: TOTAL DISSOLVED SOLIDS						Analyst: KS
Total Dissolved Solids	2790	50.0	*	mg/L	1	6/9/2023 12:39:00 PM
SM 4500 NORG C: TKN						Analyst: DML
Nitrogen, Kjeldahl, Total	ND	1.0		mg/L	1	6/15/2023 8:43:00 AM

Refer to the QC Summary report and sample login checklist for flagged QC data and preservation information.

Qualifiers:	*	Value exceeds Maximum Contaminant Level.	B	Analyte detected in the associated Method Blank
	D	Sample Diluted Due to Matrix	E	Above Quantitation Range/Estimated Value
	H	Holding times for preparation or analysis exceeded	J	Analyte detected below quantitation limits
	ND	Not Detected at the Reporting Limit	P	Sample pH Not In Range
	PQL	Practical Quantitative Limit	RL	Reporting Limit
	S	% Recovery outside of standard limits. If undiluted results may be estimated.		

Hall Environmental Analysis Laboratory, Inc.

Analytical Report

Lab Order 2306078

Date Reported: 6/21/2023

CLIENT: EA Engineering

Client Sample ID: DAD-19

Project: Dona Ana Dairies

Collection Date: 6/1/2023 12:20:00 PM

Lab ID: 2306078-002

Matrix: GROUNDWA

Received Date: 6/2/2023 8:50:00 AM

Analyses	Result	RL	Qual	Units	DF	Date Analyzed
EPA METHOD 300.0: ANIONS						Analyst: JTT
Chloride	980	50	*	mg/L	100	6/2/2023 1:12:52 PM
Nitrogen, Nitrite (As N)	ND	1.0		mg/L	10	6/2/2023 1:00:01 PM
Nitrogen, Nitrate (As N)	33	1.0	*	mg/L	10	6/2/2023 1:00:01 PM
SM2540C MOD: TOTAL DISSOLVED SOLIDS						Analyst: KS
Total Dissolved Solids	3060	50.0	*	mg/L	1	6/9/2023 12:39:00 PM
SM 4500 NORG C: TKN						Analyst: DML
Nitrogen, Kjeldahl, Total	ND	5.0	D	mg/L	1	6/15/2023 8:43:00 AM

Refer to the QC Summary report and sample login checklist for flagged QC data and preservation information.

Qualifiers:

- * Value exceeds Maximum Contaminant Level.
- D Sample Diluted Due to Matrix
- H Holding times for preparation or analysis exceeded
- ND Not Detected at the Reporting Limit
- PQL Practical Quantitative Limit
- S % Recovery outside of standard limits. If undiluted results may be estimated.

- B Analyte detected in the associated Method Blank
- E Above Quantitation Range/Estimated Value
- J Analyte detected below quantitation limits
- P Sample pH Not In Range
- RL Reporting Limit

Hall Environmental Analysis Laboratory, Inc.

Analytical Report

Lab Order 2306078

Date Reported: 6/21/2023

CLIENT: EA Engineering

Client Sample ID: DAD-17

Project: Dona Ana Dairies

Collection Date: 6/1/2023 2:36:00 PM

Lab ID: 2306078-003

Matrix: GROUNDWA

Received Date: 6/2/2023 8:50:00 AM

Analyses	Result	RL	Qual	Units	DF	Date Analyzed
EPA METHOD 300.0: ANIONS						Analyst: JTT
Chloride	190	5.0		mg/L	10	6/2/2023 1:25:44 PM
Nitrogen, Nitrite (As N)	ND	1.0		mg/L	10	6/2/2023 1:25:44 PM
Nitrogen, Nitrate (As N)	ND	1.0		mg/L	10	6/2/2023 1:25:44 PM
SM2540C MOD: TOTAL DISSOLVED SOLIDS						Analyst: KS
Total Dissolved Solids	968	100	*D	mg/L	1	6/9/2023 12:39:00 PM
SM 4500 NORG C: TKN						Analyst: DML
Nitrogen, Kjeldahl, Total	ND	1.0		mg/L	1	6/15/2023 8:43:00 AM

Refer to the QC Summary report and sample login checklist for flagged QC data and preservation information.

Qualifiers:	*	Value exceeds Maximum Contaminant Level.	B	Analyte detected in the associated Method Blank
	D	Sample Diluted Due to Matrix	E	Above Quantitation Range/Estimated Value
	H	Holding times for preparation or analysis exceeded	J	Analyte detected below quantitation limits
	ND	Not Detected at the Reporting Limit	P	Sample pH Not In Range
	PQL	Practical Quantitative Limit	RL	Reporting Limit
	S	% Recovery outside of standard limits. If undiluted results may be estimated.		

Hall Environmental Analysis Laboratory, Inc.

Analytical Report

Lab Order 2306078

Date Reported: 6/21/2023

CLIENT: EA Engineering

Client Sample ID: DAD-05

Project: Dona Ana Dairies

Collection Date: 6/1/2023 3:50:00 PM

Lab ID: 2306078-004

Matrix: GROUNDWA

Received Date: 6/2/2023 8:50:00 AM

Analyses	Result	RL	Qual	Units	DF	Date Analyzed
EPA METHOD 300.0: ANIONS						Analyst: JTT
Chloride	120	5.0		mg/L	10	6/2/2023 1:51:28 PM
Nitrogen, Nitrite (As N)	ND	1.0		mg/L	10	6/2/2023 1:51:28 PM
Nitrogen, Nitrate (As N)	ND	1.0		mg/L	10	6/2/2023 1:51:28 PM
SM2540C MOD: TOTAL DISSOLVED SOLIDS						Analyst: KS
Total Dissolved Solids	785	250	*D	mg/L	1	6/9/2023 12:39:00 PM
SM 4500 NORG C: TKN						Analyst: DML
Nitrogen, Kjeldahl, Total	5.6	5.0	D	mg/L	1	6/15/2023 8:43:00 AM

Refer to the QC Summary report and sample login checklist for flagged QC data and preservation information.

Qualifiers:	*	Value exceeds Maximum Contaminant Level.	B	Analyte detected in the associated Method Blank
	D	Sample Diluted Due to Matrix	E	Above Quantitation Range/Estimated Value
	H	Holding times for preparation or analysis exceeded	J	Analyte detected below quantitation limits
	ND	Not Detected at the Reporting Limit	P	Sample pH Not In Range
	PQL	Practical Quantitative Limit	RL	Reporting Limit
	S	% Recovery outside of standard limits. If undiluted results may be estimated.		

QC SUMMARY REPORT

Hall Environmental Analysis Laboratory, Inc.

WO#: 2306078

21-Jun-23

Client: EA Engineering
Project: Dona Ana Dairies

Sample ID: MB	SampType: MBLK	TestCode: EPA Method 300.0: Anions								
Client ID: PBW	Batch ID: R97187	RunNo: 97187								
Prep Date:	Analysis Date: 6/2/2023	SeqNo: 3529610	Units: mg/L							
Analyte	Result	PQL	SPK value	SPK Ref Val	%REC	LowLimit	HighLimit	%RPD	RPDLimit	Qual
Chloride	ND	0.50								
Nitrogen, Nitrite (As N)	ND	0.10								
Nitrogen, Nitrate (As N)	ND	0.10								

Sample ID: LCS	SampType: LCS	TestCode: EPA Method 300.0: Anions								
Client ID: LCSW	Batch ID: R97187	RunNo: 97187								
Prep Date:	Analysis Date: 6/2/2023	SeqNo: 3529611	Units: mg/L							
Analyte	Result	PQL	SPK value	SPK Ref Val	%REC	LowLimit	HighLimit	%RPD	RPDLimit	Qual
Chloride	4.6	0.50	5.000	0	92.4	90	110			
Nitrogen, Nitrite (As N)	0.96	0.10	1.000	0	95.9	90	110			
Nitrogen, Nitrate (As N)	2.5	0.10	2.500	0	98.8	90	110			

Sample ID: 2306078-001AMS	SampType: MS	TestCode: EPA Method 300.0: Anions								
Client ID: DAD-24	Batch ID: R97187	RunNo: 97187								
Prep Date:	Analysis Date: 6/2/2023	SeqNo: 3529621	Units: mg/L							
Analyte	Result	PQL	SPK value	SPK Ref Val	%REC	LowLimit	HighLimit	%RPD	RPDLimit	Qual
Nitrogen, Nitrite (As N)	9.3	1.0	10.00	0	93.4	83	110			
Nitrogen, Nitrate (As N)	31	1.0	25.00	6.026	100	89.8	110			

Sample ID: 2306078-001AMSD	SampType: MSD	TestCode: EPA Method 300.0: Anions								
Client ID: DAD-24	Batch ID: R97187	RunNo: 97187								
Prep Date:	Analysis Date: 6/2/2023	SeqNo: 3529622	Units: mg/L							
Analyte	Result	PQL	SPK value	SPK Ref Val	%REC	LowLimit	HighLimit	%RPD	RPDLimit	Qual
Nitrogen, Nitrite (As N)	9.2	1.0	10.00	0	92.4	81	110	1.09	20	
Nitrogen, Nitrate (As N)	31	1.0	25.00	6.026	99.1	87.7	111	0.867	20	

Qualifiers:

- * Value exceeds Maximum Contaminant Level.
- D Sample Diluted Due to Matrix
- H Holding times for preparation or analysis exceeded
- ND Not Detected at the Reporting Limit
- PQL Practical Quantitative Limit
- S % Recovery outside of standard limits. If undiluted results may be estimated.
- B Analyte detected in the associated Method Blank
- E Above Quantitation Range/Estimated Value
- J Analyte detected below quantitation limits
- P Sample pH Not In Range
- RL Reporting Limit

QC SUMMARY REPORT

Hall Environmental Analysis Laboratory, Inc.

WO#: 2306078

21-Jun-23

Client: EA Engineering
Project: Dona Ana Dairies

Sample ID: MB-75413	SampType: MBLK	TestCode: SM2540C MOD: Total Dissolved Solids								
Client ID: PBW	Batch ID: 75413	RunNo: 97324								
Prep Date: 6/7/2023	Analysis Date: 6/9/2023	SeqNo: 3535561	Units: mg/L							
Analyte	Result	PQL	SPK value	SPK Ref Val	%REC	LowLimit	HighLimit	%RPD	RPDLimit	Qual
Total Dissolved Solids	ND	50.0								

Sample ID: LCS-75413	SampType: LCS	TestCode: SM2540C MOD: Total Dissolved Solids								
Client ID: LCSW	Batch ID: 75413	RunNo: 97324								
Prep Date: 6/7/2023	Analysis Date: 6/9/2023	SeqNo: 3535562	Units: mg/L							
Analyte	Result	PQL	SPK value	SPK Ref Val	%REC	LowLimit	HighLimit	%RPD	RPDLimit	Qual
Total Dissolved Solids	1000	50.0	1000	0	100	80	120			

Sample ID: 2306078-001ADUP	SampType: DUP	TestCode: SM2540C MOD: Total Dissolved Solids								
Client ID: DAD-24	Batch ID: 75413	RunNo: 97324								
Prep Date: 6/7/2023	Analysis Date: 6/9/2023	SeqNo: 3535566	Units: mg/L							
Analyte	Result	PQL	SPK value	SPK Ref Val	%REC	LowLimit	HighLimit	%RPD	RPDLimit	Qual
Total Dissolved Solids	2760	50.0						0.829	10	*

Qualifiers:

- | | |
|---|---|
| * Value exceeds Maximum Contaminant Level. | B Analyte detected in the associated Method Blank |
| D Sample Diluted Due to Matrix | E Above Quantitation Range/Estimated Value |
| H Holding times for preparation or analysis exceeded | J Analyte detected below quantitation limits |
| ND Not Detected at the Reporting Limit | P Sample pH Not In Range |
| PQL Practical Quantitative Limit | RL Reporting Limit |
| S % Recovery outside of standard limits. If undiluted results may be estimated. | |

QC SUMMARY REPORT

Hall Environmental Analysis Laboratory, Inc.

WO#: 2306078

21-Jun-23

Client: EA Engineering
Project: Dona Ana Dairies

Sample ID: MB-75585	SampType: MBLK	TestCode: SM 4500 Norg C: TKN								
Client ID: PBW	Batch ID: 75585	RunNo: 97475								
Prep Date: 6/14/2023	Analysis Date: 6/15/2023	SeqNo: 3541554	Units: mg/L							
Analyte	Result	PQL	SPK value	SPK Ref Val	%REC	LowLimit	HighLimit	%RPD	RPDLimit	Qual
Nitrogen, Kjeldahl, Total	ND	1.0								

Sample ID: LCS-75585	SampType: LCS	TestCode: SM 4500 Norg C: TKN								
Client ID: LCSW	Batch ID: 75585	RunNo: 97475								
Prep Date: 6/14/2023	Analysis Date: 6/15/2023	SeqNo: 3541555	Units: mg/L							
Analyte	Result	PQL	SPK value	SPK Ref Val	%REC	LowLimit	HighLimit	%RPD	RPDLimit	Qual
Nitrogen, Kjeldahl, Total	10	1.0	10.00	0	102	80	120			

Qualifiers:

- * Value exceeds Maximum Contaminant Level.
- D Sample Diluted Due to Matrix
- H Holding times for preparation or analysis exceeded
- ND Not Detected at the Reporting Limit
- PQL Practical Quantitative Limit
- S % Recovery outside of standard limits. If undiluted results may be estimated.
- B Analyte detected in the associated Method Blank
- E Above Quantitation Range/Estimated Value
- J Analyte detected below quantitation limits
- P Sample pH Not In Range
- RL Reporting Limit

Sample Log-In Check List

Client Name: EA Engineering

Work Order Number: 2306078

RcptNo: 1

Received By: Desiree Dominguez 6/2/2023 8:50:00 AM

DD

Completed By: Tracy Casarrubias 6/2/2023 9:34:36 AM

Reviewed By: *JN 6/2/23*

Chain of Custody

1. Is Chain of Custody complete? Yes No Not Present
 2. How was the sample delivered? FedEx

Log In

3. Was an attempt made to cool the samples? Yes No NA
 4. Were all samples received at a temperature of >0° C to 6.0°C Yes No NA
 5. Sample(s) in proper container(s)? Yes No
 6. Sufficient sample volume for indicated test(s)? Yes No
 7. Are samples (except VOA and ONG) properly preserved? Yes No
 8. Was preservative added to bottles? Yes No NA
 9. Received at least 1 vial with headspace <1/4" for AQ VOA? Yes No NA
 10. Were any sample containers received broken? Yes No
 11. Does paperwork match bottle labels? Yes No
 (Note discrepancies on chain of custody)
 12. Are matrices correctly identified on Chain of Custody? Yes No
 13. Is it clear what analyses were requested? Yes No
 14. Were all holding times able to be met? Yes No
 (If no, notify customer for authorization.)

pH strip lot# 538534
 # of preserved bottles checked for pH: *4*
 Adjusted? *No* (3 or >12 unless noted)
 Checked by: *UJ 6-2-23*

Special Handling (if applicable)

15. Was client notified of all discrepancies with this order? Yes No NA

Person Notified: _____ Date: _____
 By Whom: _____ Via: eMail Phone Fax In Person
 Regarding: _____
 Client Instructions: _____

16. Additional remarks:

17. Cooler Information

Cooler No	Temp °C	Condition	Seal Intact	Seal No	Seal Date	Signed By
1	0.7	Good	Not Present	Morty		

Chain-of-Custody Record

Turn-Around Time: Standard Rush
 Project Name: Dona Ana Dairies (DAD'S)
 Project #:

Client: EA Engineering, Science, and Technology
 Mailing Address: 320 Gold Ave SW Suite
 Phone #: 505-715-4279
 email or Fax#: rmullen@east.com

Project Manager: Gina Mullen
 Sampler: Angel N. Rivera
 On Ice: Yes No
 # of Coolers: 1 Morty
 Cooler Temp (including CF): 0.8 - 0.1 = 0.72

QA/QC Package: Level 4 (Full Validation)
 Accreditation: Az Compliance
 NELAC Other
 EDD (Type)

Date	Time	Matrix	Sample Name	Container Type and #	Preservative Type	HEAL No.
6-1	10:56	Gw	DAD-24	2		73060078
6-1	12:20	Gw	DAD-19	2		001
6-1	14:36	Gw	DAD-17	2		002
6-1	15:50	Gw	DAD-05	2		003
						004

Date: 6-1 Time: 17:20 Relinquished by: Chal m
 Date: 6-1 Time: 8:50 Relinquished by: JSB
 Received by: JSB Date: 6/2/23 Time: 8:50
 Via: Fed Ex
 Received by: JSB Date: 6/2/23 Time: 8:50
 Via: Fed Ex



HALL ENVIRONMENTAL ANALYSIS LABORATORY
 www.hallenvironmental.com
 4901 Hawkins NE - Albuquerque, NM 87109
 Tel. 505-345-3975 Fax 505-345-4107

Analysis Request

Nitrate/Nitrites EPA Method 300	TKN SM 4500 NORG C	Chloride EPA 300	TDS SM 2540 C MOD	Sulfate EPA 300	Phosphorus EPA 6010B	Total Sulfur
X	X	X	X			
X	X	X	X			
X	X	X	X			
X	X	X	X			

Remarks:

If necessary, samples submitted to Hall Environmental may be subcontracted to other accredited laboratories. This serves as notice of this possibility. Any sub-contracted data will be clearly notated on the analytical report.



Hall Environmental Analysis Laboratory
4901 Hawkins NE
Albuquerque, NM 87109
TEL: 505-345-3975 FAX: 505-345-4107
Website: www.hallenvironmental.com

June 22, 2023

Regina Mullen
EA Engineering
320 Gold Ave SW Suite 1210
Albuquerque, NM 87102
TEL:
FAX:

RE: Dona Ana Dairies

OrderNo.: 2306199

Dear Regina Mullen:

Hall Environmental Analysis Laboratory received 4 sample(s) on 6/6/2023 for the analyses presented in the following report.

These were analyzed according to EPA procedures or equivalent. To access our accredited tests please go to www.hallenvironmental.com or the state specific web sites. In order to properly interpret your results, it is imperative that you review this report in its entirety. See the sample checklist and/or the Chain of Custody for information regarding the sample receipt temperature and preservation. Data qualifiers or a narrative will be provided if the sample analysis or analytical quality control parameters require a flag. When necessary, data qualifiers are provided on both the sample analysis report and the QC summary report, both sections should be reviewed. All samples are reported, as received, unless otherwise indicated. Lab measurement of analytes considered field parameters that require analysis within 15 minutes of sampling such as pH and residual chlorine are qualified as being analyzed outside of the recommended holding time.

Please don't hesitate to contact HEAL for any additional information or clarifications.

ADHS Cert #AZ0682 -- NMED-DWB Cert #NM9425 -- NMED-Micro Cert #NM0901

Sincerely,

A handwritten signature in black ink, appearing to read 'Andy Freeman', is written in a cursive style.

Andy Freeman
Laboratory Manager
4901 Hawkins NE
Albuquerque, NM 87109

Hall Environmental Analysis Laboratory, Inc.

Analytical Report

Lab Order 2306199

Date Reported: 6/22/2023

CLIENT: EA Engineering

Client Sample ID: DAD-18

Project: Dona Ana Dairies

Collection Date: 6/5/2023 10:56:00 AM

Lab ID: 2306199-001

Matrix: GROUNDWA

Received Date: 6/6/2023 8:45:00 AM

Analyses	Result	RL	Qual	Units	DF	Date Analyzed
EPA METHOD 300.0: ANIONS						Analyst: JMT
Chloride	680	50	*	mg/L	100	6/6/2023 5:33:38 PM
Nitrogen, Nitrite (As N)	ND	1.0		mg/L	10	6/6/2023 5:20:45 PM
Nitrogen, Nitrate (As N)	7.4	1.0		mg/L	10	6/6/2023 5:20:45 PM
SM2540C MOD: TOTAL DISSOLVED SOLIDS						Analyst: JAG
Total Dissolved Solids	2660	50.0	*	mg/L	1	6/9/2023 1:52:00 PM
SM 4500 NORG C: TKN						Analyst: DML
Nitrogen, Kjeldahl, Total	ND	1.0		mg/L	1	6/16/2023 9:41:00 AM

Refer to the QC Summary report and sample login checklist for flagged QC data and preservation information.

Qualifiers:	*	Value exceeds Maximum Contaminant Level.	B	Analyte detected in the associated Method Blank
	D	Sample Diluted Due to Matrix	E	Above Quantitation Range/Estimated Value
	H	Holding times for preparation or analysis exceeded	J	Analyte detected below quantitation limits
	ND	Not Detected at the Reporting Limit	P	Sample pH Not In Range
	PQL	Practical Quantitative Limit	RL	Reporting Limit
	S	% Recovery outside of standard limits. If undiluted results may be estimated.		

Hall Environmental Analysis Laboratory, Inc.

Analytical Report

Lab Order 2306199

Date Reported: 6/22/2023

CLIENT: EA Engineering

Client Sample ID: DAD-08

Project: Dona Ana Dairies

Collection Date: 6/5/2023 12:10:00 PM

Lab ID: 2306199-002

Matrix: GROUNDWA

Received Date: 6/6/2023 8:45:00 AM

Analyses	Result	RL	Qual	Units	DF	Date Analyzed
EPA METHOD 300.0: ANIONS						Analyst: JMT
Chloride	1600	50	*	mg/L	100	6/6/2023 5:59:23 PM
Nitrogen, Nitrite (As N)	ND	1.0		mg/L	10	6/6/2023 5:46:31 PM
Nitrogen, Nitrate (As N)	44	1.0	*	mg/L	10	6/6/2023 5:46:31 PM
SM2540C MOD: TOTAL DISSOLVED SOLIDS						Analyst: JAG
Total Dissolved Solids	4240	250	*D	mg/L	1	6/9/2023 1:52:00 PM
SM 4500 NORG C: TKN						Analyst: DML
Nitrogen, Kjeldahl, Total	ND	5.0	D	mg/L	1	6/19/2023 1:38:00 PM

Refer to the QC Summary report and sample login checklist for flagged QC data and preservation information.

Qualifiers:

- * Value exceeds Maximum Contaminant Level.
- D Sample Diluted Due to Matrix
- H Holding times for preparation or analysis exceeded
- ND Not Detected at the Reporting Limit
- PQL Practical Quantitative Limit
- S % Recovery outside of standard limits. If undiluted results may be estimated.

- B Analyte detected in the associated Method Blank
- E Above Quantitation Range/Estimated Value
- J Analyte detected below quantitation limits
- P Sample pH Not In Range
- RL Reporting Limit

Hall Environmental Analysis Laboratory, Inc.

Analytical Report

Lab Order 2306199

Date Reported: 6/22/2023

CLIENT: EA Engineering

Client Sample ID: DAD-25

Project: Dona Ana Dairies

Collection Date: 6/5/2023 2:28:00 PM

Lab ID: 2306199-003

Matrix: GROUNDWA

Received Date: 6/6/2023 8:45:00 AM

Analyses	Result	RL	Qual	Units	DF	Date Analyzed
EPA METHOD 300.0: ANIONS						Analyst: JMT
Chloride	780	50	*	mg/L	100	6/6/2023 6:50:51 PM
Nitrogen, Nitrite (As N)	ND	1.0		mg/L	10	6/6/2023 6:37:58 PM
Nitrogen, Nitrate (As N)	7.9	1.0		mg/L	10	6/6/2023 6:37:58 PM
SM2540C MOD: TOTAL DISSOLVED SOLIDS						Analyst: JAG
Total Dissolved Solids	2160	250	*D	mg/L	1	6/9/2023 1:52:00 PM
SM 4500 NORG C: TKN						Analyst: DML
Nitrogen, Kjeldahl, Total	ND	1.0		mg/L	1	6/19/2023 1:38:00 PM

Refer to the QC Summary report and sample login checklist for flagged QC data and preservation information.

Qualifiers:

- * Value exceeds Maximum Contaminant Level.
- D Sample Diluted Due to Matrix
- H Holding times for preparation or analysis exceeded
- ND Not Detected at the Reporting Limit
- PQL Practical Quantitative Limit
- S % Recovery outside of standard limits. If undiluted results may be estimated.

- B Analyte detected in the associated Method Blank
- E Above Quantitation Range/Estimated Value
- J Analyte detected below quantitation limits
- P Sample pH Not In Range
- RL Reporting Limit

Hall Environmental Analysis Laboratory, Inc.

Analytical Report

Lab Order 2306199

Date Reported: 6/22/2023

CLIENT: EA Engineering

Client Sample ID: DAD-07

Project: Dona Ana Dairies

Collection Date: 6/5/2023 3:55:00 PM

Lab ID: 2306199-004

Matrix: GROUNDWA

Received Date: 6/6/2023 8:45:00 AM

Analyses	Result	RL	Qual	Units	DF	Date Analyzed
EPA METHOD 300.0: ANIONS						Analyst: JMT
Chloride	530	50	*	mg/L	100	6/6/2023 7:42:20 PM
Nitrogen, Nitrite (As N)	ND	1.0		mg/L	10	6/6/2023 7:03:44 PM
Nitrogen, Nitrate (As N)	25	1.0	*	mg/L	10	6/6/2023 7:03:44 PM
SM2540C MOD: TOTAL DISSOLVED SOLIDS						Analyst: JAG
Total Dissolved Solids	2400	100	*D	mg/L	1	6/9/2023 1:52:00 PM
SM 4500 NORG C: TKN						Analyst: DML
Nitrogen, Kjeldahl, Total	ND	5.0	D	mg/L	1	6/19/2023 1:38:00 PM

Refer to the QC Summary report and sample login checklist for flagged QC data and preservation information.

Qualifiers:	*	Value exceeds Maximum Contaminant Level.	B	Analyte detected in the associated Method Blank
	D	Sample Diluted Due to Matrix	E	Above Quantitation Range/Estimated Value
	H	Holding times for preparation or analysis exceeded	J	Analyte detected below quantitation limits
	ND	Not Detected at the Reporting Limit	P	Sample pH Not In Range
	PQL	Practical Quantitative Limit	RL	Reporting Limit
	S	% Recovery outside of standard limits. If undiluted results may be estimated.		

QC SUMMARY REPORT

Hall Environmental Analysis Laboratory, Inc.

WO#: 2306199

22-Jun-23

Client: EA Engineering
Project: Dona Ana Dairies

Sample ID: MB	SampType: mblk	TestCode: EPA Method 300.0: Anions								
Client ID: PBW	Batch ID: R97258	RunNo: 97258								
Prep Date:	Analysis Date: 6/6/2023	SeqNo: 3532508			Units: mg/L					
Analyte	Result	PQL	SPK value	SPK Ref Val	%REC	LowLimit	HighLimit	%RPD	RPDLimit	Qual
Chloride	ND	0.50								
Nitrogen, Nitrite (As N)	ND	0.10								
Nitrogen, Nitrate (As N)	ND	0.10								

Sample ID: LCS	SampType: ics	TestCode: EPA Method 300.0: Anions								
Client ID: LCSW	Batch ID: R97258	RunNo: 97258								
Prep Date:	Analysis Date: 6/6/2023	SeqNo: 3532509			Units: mg/L					
Analyte	Result	PQL	SPK value	SPK Ref Val	%REC	LowLimit	HighLimit	%RPD	RPDLimit	Qual
Chloride	4.7	0.50	5.000	0	94.3	90	110			
Nitrogen, Nitrite (As N)	0.97	0.10	1.000	0	96.9	90	110			
Nitrogen, Nitrate (As N)	2.5	0.10	2.500	0	101	90	110			

Sample ID: 2306199-004AMS	SampType: ms	TestCode: EPA Method 300.0: Anions								
Client ID: DAD-07	Batch ID: R97258	RunNo: 97258								
Prep Date:	Analysis Date: 6/6/2023	SeqNo: 3532546			Units: mg/L					
Analyte	Result	PQL	SPK value	SPK Ref Val	%REC	LowLimit	HighLimit	%RPD	RPDLimit	Qual
Nitrogen, Nitrite (As N)	9.5	1.0	10.00	0	94.6	83	110			
Nitrogen, Nitrate (As N)	51	1.0	25.00	24.92	106	89.8	110			

Sample ID: 2306199-004AMSD	SampType: msd	TestCode: EPA Method 300.0: Anions								
Client ID: DAD-07	Batch ID: R97258	RunNo: 97258								
Prep Date:	Analysis Date: 6/6/2023	SeqNo: 3532547			Units: mg/L					
Analyte	Result	PQL	SPK value	SPK Ref Val	%REC	LowLimit	HighLimit	%RPD	RPDLimit	Qual
Nitrogen, Nitrite (As N)	9.6	1.0	10.00	0	95.7	81	110	1.21	20	
Nitrogen, Nitrate (As N)	52	1.0	25.00	24.92	108	87.7	111	0.893	20	

Sample ID: MB	SampType: mblk	TestCode: EPA Method 300.0: Anions								
Client ID: PBW	Batch ID: R97258	RunNo: 97258								
Prep Date:	Analysis Date: 6/6/2023	SeqNo: 3532555			Units: mg/L					
Analyte	Result	PQL	SPK value	SPK Ref Val	%REC	LowLimit	HighLimit	%RPD	RPDLimit	Qual
Chloride	ND	0.50								
Nitrogen, Nitrite (As N)	ND	0.10								
Nitrogen, Nitrate (As N)	ND	0.10								

Qualifiers:

- * Value exceeds Maximum Contaminant Level.
- D Sample Diluted Due to Matrix
- H Holding times for preparation or analysis exceeded
- ND Not Detected at the Reporting Limit
- PQL Practical Quantitative Limit
- S % Recovery outside of standard limits. If undiluted results may be estimated.
- B Analyte detected in the associated Method Blank
- E Above Quantitation Range/Estimated Value
- J Analyte detected below quantitation limits
- P Sample pH Not In Range
- RL Reporting Limit

QC SUMMARY REPORT

Hall Environmental Analysis Laboratory, Inc.

WO#: 2306199

22-Jun-23

Client: EA Engineering
Project: Dona Ana Dairies

Sample ID: LCS	SampType: lcs		TestCode: EPA Method 300.0: Anions							
Client ID: LCSW	Batch ID: R97258		RunNo: 97258							
Prep Date:	Analysis Date: 6/6/2023		SeqNo: 3532556		Units: mg/L					
Analyte	Result	PQL	SPK value	SPK Ref Val	%REC	LowLimit	HighLimit	%RPD	RPDLimit	Qual
Chloride	4.8	0.50	5.000	0	95.2	90	110			
Nitrogen, Nitrite (As N)	0.98	0.10	1.000	0	97.8	90	110			
Nitrogen, Nitrate (As N)	2.5	0.10	2.500	0	102	90	110			

Qualifiers:

- * Value exceeds Maximum Contaminant Level.
- D Sample Diluted Due to Matrix
- H Holding times for preparation or analysis exceeded
- ND Not Detected at the Reporting Limit
- PQL Practical Quantitative Limit
- S % Recovery outside of standard limits. If undiluted results may be estimated.
- B Analyte detected in the associated Method Blank
- E Above Quantitation Range/Estimated Value
- J Analyte detected below quantitation limits
- P Sample pH Not In Range
- RL Reporting Limit

QC SUMMARY REPORT

Hall Environmental Analysis Laboratory, Inc.

WO#: 2306199

22-Jun-23

Client: EA Engineering
Project: Dona Ana Dairies

Sample ID: MB-75457	SampType: MBLK	TestCode: SM2540C MOD: Total Dissolved Solids								
Client ID: PBW	Batch ID: 75457	RunNo: 97327								
Prep Date: 6/8/2023	Analysis Date: 6/9/2023	SeqNo: 3535785	Units: mg/L							
Analyte	Result	PQL	SPK value	SPK Ref Val	%REC	LowLimit	HighLimit	%RPD	RPDLimit	Qual
Total Dissolved Solids	ND	50.0								

Sample ID: LCS-75457	SampType: LCS	TestCode: SM2540C MOD: Total Dissolved Solids								
Client ID: LCSW	Batch ID: 75457	RunNo: 97327								
Prep Date: 6/8/2023	Analysis Date: 6/9/2023	SeqNo: 3535786	Units: mg/L							
Analyte	Result	PQL	SPK value	SPK Ref Val	%REC	LowLimit	HighLimit	%RPD	RPDLimit	Qual
Total Dissolved Solids	1020	50.0	1000	0	102	80	120			

Sample ID: 2306199-001ADUP	SampType: DUP	TestCode: SM2540C MOD: Total Dissolved Solids								
Client ID: DAD-18	Batch ID: 75457	RunNo: 97327								
Prep Date: 6/8/2023	Analysis Date: 6/9/2023	SeqNo: 3535788	Units: mg/L							
Analyte	Result	PQL	SPK value	SPK Ref Val	%REC	LowLimit	HighLimit	%RPD	RPDLimit	Qual
Total Dissolved Solids	2660	50.0						0.151	10	*

Qualifiers:

- * Value exceeds Maximum Contaminant Level.
- D Sample Diluted Due to Matrix
- H Holding times for preparation or analysis exceeded
- ND Not Detected at the Reporting Limit
- PQL Practical Quantitative Limit
- S % Recovery outside of standard limits. If undiluted results may be estimated.
- B Analyte detected in the associated Method Blank
- E Above Quantitation Range/Estimated Value
- J Analyte detected below quantitation limits
- P Sample pH Not In Range
- RL Reporting Limit

QC SUMMARY REPORT

Hall Environmental Analysis Laboratory, Inc.

WO#: 2306199

22-Jun-23

Client: EA Engineering
Project: Dona Ana Dairies

Sample ID: MB-75625	SampType: MBLK	TestCode: SM 4500 Norg C: TKN								
Client ID: PBW	Batch ID: 75625	RunNo: 97509								
Prep Date: 6/15/2023	Analysis Date: 6/16/2023	SeqNo: 3543118	Units: mg/L							
Analyte	Result	PQL	SPK value	SPK Ref Val	%REC	LowLimit	HighLimit	%RPD	RPDLimit	Qual
Nitrogen, Kjeldahl, Total	ND	1.0								

Sample ID: LCS-75625	SampType: LCS	TestCode: SM 4500 Norg C: TKN								
Client ID: LCSW	Batch ID: 75625	RunNo: 97509								
Prep Date: 6/15/2023	Analysis Date: 6/16/2023	SeqNo: 3543119	Units: mg/L							
Analyte	Result	PQL	SPK value	SPK Ref Val	%REC	LowLimit	HighLimit	%RPD	RPDLimit	Qual
Nitrogen, Kjeldahl, Total	10	1.0	10.00	0	101	80	120			

Sample ID: MB-75626	SampType: MBLK	TestCode: SM 4500 Norg C: TKN								
Client ID: PBW	Batch ID: 75626	RunNo: 97568								
Prep Date: 6/15/2023	Analysis Date: 6/19/2023	SeqNo: 3546985	Units: mg/L							
Analyte	Result	PQL	SPK value	SPK Ref Val	%REC	LowLimit	HighLimit	%RPD	RPDLimit	Qual
Nitrogen, Kjeldahl, Total	ND	1.0								

Sample ID: LCS-75626	SampType: LCS	TestCode: SM 4500 Norg C: TKN								
Client ID: LCSW	Batch ID: 75626	RunNo: 97568								
Prep Date: 6/15/2023	Analysis Date: 6/19/2023	SeqNo: 3546986	Units: mg/L							
Analyte	Result	PQL	SPK value	SPK Ref Val	%REC	LowLimit	HighLimit	%RPD	RPDLimit	Qual
Nitrogen, Kjeldahl, Total	10	1.0	10.00	0	101	80	120			

Qualifiers:

- | | |
|---|---|
| * Value exceeds Maximum Contaminant Level. | B Analyte detected in the associated Method Blank |
| D Sample Diluted Due to Matrix | E Above Quantitation Range/Estimated Value |
| H Holding times for preparation or analysis exceeded | J Analyte detected below quantitation limits |
| ND Not Detected at the Reporting Limit | P Sample pH Not In Range |
| PQL Practical Quantitative Limit | RL Reporting Limit |
| S % Recovery outside of standard limits. If undiluted results may be estimated. | |



Sample Log-In Check List

Client Name: EA Engineering

Work Order Number: 2306199

RcptNo: 1

Received By: Desiree Dominguez 6/6/2023 8:45:00 AM

DD

Completed By: Desiree Dominguez 6/6/2023 10:19:21 AM

DD

Reviewed By: *WJW 6/6/23*

Chain of Custody

1. Is Chain of Custody complete? Yes No Not Present
2. How was the sample delivered? FedEx

Log In

3. Was an attempt made to cool the samples? Yes No NA
4. Were all samples received at a temperature of >0° C to 6.0°C Yes No NA
5. Sample(s) in proper container(s)? Yes No
6. Sufficient sample volume for indicated test(s)? Yes No
7. Are samples (except VOA and ONG) properly preserved? Yes No
8. Was preservative added to bottles? Yes No NA
9. Received at least 1 vial with headspace <1/4" for AQ VOA? Yes No NA
10. Were any sample containers received broken? Yes No
11. Does paperwork match bottle labels?
(Note discrepancies on chain of custody) Yes No
12. Are matrices correctly identified on Chain of Custody? Yes No
13. Is it clear what analyses were requested? Yes No
14. Were all holding times able to be met?
(If no, notify customer for authorization.) Yes No

of preserved bottles checked for pH: 4
 (<2 or >12 unless noted)
 Adjusted? NO
 Checked by: WJW 6/6/23
ph Lot # 538534

Special Handling (if applicable)

15. Was client notified of all discrepancies with this order? Yes No NA

Person Notified:	<input type="text"/>	Date:	<input type="text"/>
By Whom:	<input type="text"/>	Via:	<input type="checkbox"/> eMail <input type="checkbox"/> Phone <input type="checkbox"/> Fax <input type="checkbox"/> In Person
Regarding:	<input type="text"/>		
Client Instructions:	<input type="text"/>		

16. Additional remarks:

17. Cooler Information

Cooler No	Temp °C	Condition	Seal Intact	Seal No	Seal Date	Signed By
1	0.1	Good	Not Present	Morty		

Chain-of-Custody Record

Client: **EA Engineering, Science, and Technology**
 Mailing Address: **320 Gold Ave SW Suite**
 Phone #: **505-715-4279**
 email or Fax#: **rmullen@eaest.com**

QA/QC Package: Standard Level 4 (Full Validation)

Accreditation: Az Compliance NELAC Other

EDD (Type) _____

Sampler: **Angel N. Rivera**

On Ice: Yes No

of Coolers: **1**

Cooler Temp (including CF): **0.0 +0.1 = 0.1 °C**

Container Type and #

Preservative Type

HEAL No.

2306199

-001

-002

-003

-004

2

2

2

2

2

2

2

2

2

2

2

2

2

2

2

Turn-Around Time:

Standard Rush

Project Name: **Dona Ana Dairies (DAD'S)**

Project #: _____

Project Manager: **Gina Mullen**

Analysis Request

Nitrate/Nitrites EPA Method 300

TKN SM 4500 NOR C

Chloride EPA 300

TDS SM 2540 C MOD

Sulfate EPA 300

Phosphorus EPA 6010B

Total Sulfur

Remarks:

Received by: **DB** Date: **6/6/23** Time: **8:45**

Via: **FedEx**

Received by: _____ Date: _____ Time: _____

Via: _____

Relinquished by: **Gina Mullen**

Time: **17:30**

Relinquished by: _____

Time: _____

Relinquished by: _____

Time: _____

Relinquished by: _____

Time: _____

Relinquished by: _____

Time: _____

Relinquished by: _____

Time: _____

Relinquished by: _____

Time: _____

Relinquished by: _____

If necessary, samples submitted to Hall Environmental may be subcontracted to other accredited laboratories. This serves as notice of this possibility. Any sub-contracted data will be clearly notated on the analytical report.



Hall Environmental Analysis Laboratory
4901 Hawkins NE
Albuquerque, NM 87109
TEL: 505-345-3975 FAX: 505-345-4107
Website: www.hallenvironmental.com

June 28, 2023

Regina Mullen
EA Engineering
320 Gold Ave SW Suite 1210
Albuquerque, NM 87102
TEL:
FAX:

RE: Dona Ana Dairies

OrderNo.: 2306300

Dear Regina Mullen:

Hall Environmental Analysis Laboratory received 5 sample(s) on 6/7/2023 for the analyses presented in the following report.

These were analyzed according to EPA procedures or equivalent. To access our accredited tests please go to www.hallenvironmental.com or the state specific web sites. In order to properly interpret your results, it is imperative that you review this report in its entirety. See the sample checklist and/or the Chain of Custody for information regarding the sample receipt temperature and preservation. Data qualifiers or a narrative will be provided if the sample analysis or analytical quality control parameters require a flag. When necessary, data qualifiers are provided on both the sample analysis report and the QC summary report, both sections should be reviewed. All samples are reported, as received, unless otherwise indicated. Lab measurement of analytes considered field parameters that require analysis within 15 minutes of sampling such as pH and residual chlorine are qualified as being analyzed outside of the recommended holding time.

Please don't hesitate to contact HEAL for any additional information or clarifications.

ADHS Cert #AZ0682 -- NMED-DWB Cert #NM9425 -- NMED-Micro Cert #NM0901

Sincerely,

A handwritten signature in black ink, appearing to read 'Andy Freeman', is written in a cursive style.

Andy Freeman
Laboratory Manager
4901 Hawkins NE
Albuquerque, NM 87109

Hall Environmental Analysis Laboratory, Inc.

Analytical Report

Lab Order 2306300

Date Reported: 6/28/2023

CLIENT: EA Engineering

Client Sample ID: DAD-21

Project: Dona Ana Dairies

Collection Date: 6/6/2023 10:07:00 AM

Lab ID: 2306300-001

Matrix: GROUNDWA

Received Date: 6/7/2023 8:55:00 AM

Analyses	Result	RL	Qual	Units	DF	Date Analyzed
EPA METHOD 300.0: ANIONS						Analyst: JMT
Chloride	780	50	*	mg/L	100	6/7/2023 4:02:24 PM
Nitrogen, Nitrite (As N)	ND	1.0		mg/L	10	6/7/2023 3:49:33 PM
Nitrogen, Nitrate (As N)	46	1.0	*	mg/L	10	6/7/2023 3:49:33 PM
SM2540C MOD: TOTAL DISSOLVED SOLIDS						Analyst: JAG
Total Dissolved Solids	2620	250	*D	mg/L	1	6/13/2023 2:50:00 PM
SM 4500 NORG C: TKN						Analyst: DML
Nitrogen, Kjeldahl, Total	ND	5.0	D	mg/L	1	6/23/2023 8:55:00 AM

Refer to the QC Summary report and sample login checklist for flagged QC data and preservation information.

Qualifiers:	*	Value exceeds Maximum Contaminant Level.	B	Analyte detected in the associated Method Blank
	D	Sample Diluted Due to Matrix	E	Above Quantitation Range/Estimated Value
	H	Holding times for preparation or analysis exceeded	J	Analyte detected below quantitation limits
	ND	Not Detected at the Reporting Limit	P	Sample pH Not In Range
	PQL	Practical Quantitative Limit	RL	Reporting Limit
	S	% Recovery outside of standard limits. If undiluted results may be estimated.		

Hall Environmental Analysis Laboratory, Inc.

Analytical Report

Lab Order 2306300

Date Reported: 6/28/2023

CLIENT: EA Engineering

Client Sample ID: DAD-09

Project: Dona Ana Dairies

Collection Date: 6/6/2023 11:15:00 AM

Lab ID: 2306300-002

Matrix: GROUNDWA

Received Date: 6/7/2023 8:55:00 AM

Analyses	Result	RL	Qual	Units	DF	Date Analyzed
EPA METHOD 300.0: ANIONS						Analyst: JMT
Chloride	520	50	*	mg/L	100	6/7/2023 4:28:08 PM
Nitrogen, Nitrite (As N)	ND	1.0		mg/L	10	6/7/2023 4:15:16 PM
Nitrogen, Nitrate (As N)	33	1.0	*	mg/L	10	6/7/2023 4:15:16 PM
SM2540C MOD: TOTAL DISSOLVED SOLIDS						Analyst: JAG
Total Dissolved Solids	1890	100	*D	mg/L	1	6/13/2023 2:50:00 PM
SM 4500 NORG C: TKN						Analyst: DML
Nitrogen, Kjeldahl, Total	ND	5.0	D	mg/L	1	6/26/2023 10:43:00 AM

Refer to the QC Summary report and sample login checklist for flagged QC data and preservation information.

Qualifiers:

- * Value exceeds Maximum Contaminant Level.
- D Sample Diluted Due to Matrix
- H Holding times for preparation or analysis exceeded
- ND Not Detected at the Reporting Limit
- PQL Practical Quantitative Limit
- S % Recovery outside of standard limits. If undiluted results may be estimated.

- B Analyte detected in the associated Method Blank
- E Above Quantitation Range/Estimated Value
- J Analyte detected below quantitation limits
- P Sample pH Not In Range
- RL Reporting Limit

Hall Environmental Analysis Laboratory, Inc.

Analytical Report

Lab Order 2306300

Date Reported: 6/28/2023

CLIENT: EA Engineering

Client Sample ID: DAD-22

Project: Dona Ana Dairies

Collection Date: 6/6/2023 12:05:00 PM

Lab ID: 2306300-003

Matrix: GROUNDWA

Received Date: 6/7/2023 8:55:00 AM

Analyses	Result	RL	Qual	Units	DF	Date Analyzed
EPA METHOD 300.0: ANIONS						Analyst: JMT
Chloride	870	50	*	mg/L	100	6/7/2023 4:53:52 PM
Nitrogen, Nitrite (As N)	ND	1.0		mg/L	10	6/7/2023 4:41:00 PM
Nitrogen, Nitrate (As N)	15	1.0	*	mg/L	10	6/7/2023 4:41:00 PM
SM2540C MOD: TOTAL DISSOLVED SOLIDS						Analyst: JAG
Total Dissolved Solids	2360	100	*D	mg/L	1	6/13/2023 2:50:00 PM
SM 4500 NORG C: TKN						Analyst: DML
Nitrogen, Kjeldahl, Total	ND	2.0	D	mg/L	1	6/20/2023 8:48:00 AM

Refer to the QC Summary report and sample login checklist for flagged QC data and preservation information.

Qualifiers:	*	Value exceeds Maximum Contaminant Level.	B	Analyte detected in the associated Method Blank
	D	Sample Diluted Due to Matrix	E	Above Quantitation Range/Estimated Value
	H	Holding times for preparation or analysis exceeded	J	Analyte detected below quantitation limits
	ND	Not Detected at the Reporting Limit	P	Sample pH Not In Range
	PQL	Practical Quantitative Limit	RL	Reporting Limit
	S	% Recovery outside of standard limits. If undiluted results may be estimated.		

Hall Environmental Analysis Laboratory, Inc.

Analytical Report

Lab Order 2306300

Date Reported: 6/28/2023

CLIENT: EA Engineering

Client Sample ID: DAD-26

Project: Dona Ana Dairies

Collection Date: 6/6/2023 1:45:00 PM

Lab ID: 2306300-004

Matrix: GROUNDWA

Received Date: 6/7/2023 8:55:00 AM

Analyses	Result	RL	Qual	Units	DF	Date Analyzed
EPA METHOD 300.0: ANIONS						Analyst: JMT
Chloride	610	50	*	mg/L	100	6/7/2023 5:19:35 PM
Nitrogen, Nitrite (As N)	ND	1.0		mg/L	10	6/7/2023 5:06:43 PM
Nitrogen, Nitrate (As N)	22	1.0	*	mg/L	10	6/7/2023 5:06:43 PM
SM2540C MOD: TOTAL DISSOLVED SOLIDS						Analyst: JAG
Total Dissolved Solids	2010	250	*D	mg/L	1	6/14/2023 3:10:00 PM
SM 4500 NORG C: TKN						Analyst: DML
Nitrogen, Kjeldahl, Total	ND	5.0	D	mg/L	1	6/26/2023 10:43:00 AM

Refer to the QC Summary report and sample login checklist for flagged QC data and preservation information.

Qualifiers:	*	Value exceeds Maximum Contaminant Level.	B	Analyte detected in the associated Method Blank
	D	Sample Diluted Due to Matrix	E	Above Quantitation Range/Estimated Value
	H	Holding times for preparation or analysis exceeded	J	Analyte detected below quantitation limits
	ND	Not Detected at the Reporting Limit	P	Sample pH Not In Range
	PQL	Practical Quantitative Limit	RL	Reporting Limit
	S	% Recovery outside of standard limits. If undiluted results may be estimated.		

Hall Environmental Analysis Laboratory, Inc.

Analytical Report

Lab Order 2306300

Date Reported: 6/28/2023

CLIENT: EA Engineering

Client Sample ID: DAD-27

Project: Dona Ana Dairies

Collection Date: 6/6/2023 3:46:00 PM

Lab ID: 2306300-005

Matrix: GROUNDWA

Received Date: 6/7/2023 8:55:00 AM

Analyses	Result	RL	Qual	Units	DF	Date Analyzed
EPA METHOD 300.0: ANIONS						Analyst: JMT
Chloride	490	50	*	mg/L	100	6/7/2023 5:45:19 PM
Nitrogen, Nitrite (As N)	ND	1.0		mg/L	10	6/7/2023 5:32:27 PM
Nitrogen, Nitrate (As N)	7.0	1.0		mg/L	10	6/7/2023 5:32:27 PM
SM2540C MOD: TOTAL DISSOLVED SOLIDS						Analyst: JAG
Total Dissolved Solids	1490	250	*D	mg/L	1	6/14/2023 3:10:00 PM
SM 4500 NORG C: TKN						Analyst: DML
Nitrogen, Kjeldahl, Total	ND	1.0		mg/L	1	6/23/2023 8:55:00 AM

Refer to the QC Summary report and sample login checklist for flagged QC data and preservation information.

Qualifiers:	*	Value exceeds Maximum Contaminant Level.	B	Analyte detected in the associated Method Blank
	D	Sample Diluted Due to Matrix	E	Above Quantitation Range/Estimated Value
	H	Holding times for preparation or analysis exceeded	J	Analyte detected below quantitation limits
	ND	Not Detected at the Reporting Limit	P	Sample pH Not In Range
	PQL	Practical Quantitative Limit	RL	Reporting Limit
	S	% Recovery outside of standard limits. If undiluted results may be estimated.		

QC SUMMARY REPORT

Hall Environmental Analysis Laboratory, Inc.

WO#: 2306300

28-Jun-23

Client: EA Engineering
Project: Dona Ana Dairies

Sample ID: MB	SampType: mblk	TestCode: EPA Method 300.0: Anions								
Client ID: PBW	Batch ID: R97293	RunNo: 97293								
Prep Date:	Analysis Date: 6/7/2023	SeqNo: 3534301	Units: mg/L							
Analyte	Result	PQL	SPK value	SPK Ref Val	%REC	LowLimit	HighLimit	%RPD	RPDLimit	Qual
Chloride	ND	0.50								
Nitrogen, Nitrite (As N)	ND	0.10								
Nitrogen, Nitrate (As N)	ND	0.10								

Sample ID: LCS	SampType: lcs	TestCode: EPA Method 300.0: Anions								
Client ID: LCSW	Batch ID: R97293	RunNo: 97293								
Prep Date:	Analysis Date: 6/7/2023	SeqNo: 3534302	Units: mg/L							
Analyte	Result	PQL	SPK value	SPK Ref Val	%REC	LowLimit	HighLimit	%RPD	RPDLimit	Qual
Chloride	4.6	0.50	5.000	0	91.7	90	110			
Nitrogen, Nitrite (As N)	0.95	0.10	1.000	0	95.0	90	110			
Nitrogen, Nitrate (As N)	2.4	0.10	2.500	0	96.7	90	110			

Qualifiers:

- * Value exceeds Maximum Contaminant Level.
- D Sample Diluted Due to Matrix
- H Holding times for preparation or analysis exceeded
- ND Not Detected at the Reporting Limit
- PQL Practical Quantitative Limit
- S % Recovery outside of standard limits. If undiluted results may be estimated.
- B Analyte detected in the associated Method Blank
- E Above Quantitation Range/Estimated Value
- J Analyte detected below quantitation limits
- P Sample pH Not In Range
- RL Reporting Limit

QC SUMMARY REPORT

Hall Environmental Analysis Laboratory, Inc.

WO#: 2306300

28-Jun-23

Client: EA Engineering
Project: Dona Ana Dairies

Sample ID: MB-75521	SampType: MBLK	TestCode: SM2540C MOD: Total Dissolved Solids								
Client ID: PBW	Batch ID: 75521	RunNo: 97407								
Prep Date: 6/12/2023	Analysis Date: 6/13/2023	SeqNo: 3538653	Units: mg/L							
Analyte	Result	PQL	SPK value	SPK Ref Val	%REC	LowLimit	HighLimit	%RPD	RPDLimit	Qual
Total Dissolved Solids	ND	50.0								

Sample ID: LCS-75521	SampType: LCS	TestCode: SM2540C MOD: Total Dissolved Solids								
Client ID: LCSW	Batch ID: 75521	RunNo: 97407								
Prep Date: 6/12/2023	Analysis Date: 6/13/2023	SeqNo: 3538654	Units: mg/L							
Analyte	Result	PQL	SPK value	SPK Ref Val	%REC	LowLimit	HighLimit	%RPD	RPDLimit	Qual
Total Dissolved Solids	1000	50.0	1000	0	100	80	120			

Sample ID: MB-75546	SampType: MBLK	TestCode: SM2540C MOD: Total Dissolved Solids								
Client ID: PBW	Batch ID: 75546	RunNo: 97442								
Prep Date: 6/13/2023	Analysis Date: 6/14/2023	SeqNo: 3540296	Units: mg/L							
Analyte	Result	PQL	SPK value	SPK Ref Val	%REC	LowLimit	HighLimit	%RPD	RPDLimit	Qual
Total Dissolved Solids	ND	50.0								

Sample ID: LCS-75546	SampType: LCS	TestCode: SM2540C MOD: Total Dissolved Solids								
Client ID: LCSW	Batch ID: 75546	RunNo: 97442								
Prep Date: 6/13/2023	Analysis Date: 6/14/2023	SeqNo: 3540297	Units: mg/L							
Analyte	Result	PQL	SPK value	SPK Ref Val	%REC	LowLimit	HighLimit	%RPD	RPDLimit	Qual
Total Dissolved Solids	1000	50.0	1000	0	100	80	120			

Qualifiers:

- * Value exceeds Maximum Contaminant Level.
- D Sample Diluted Due to Matrix
- H Holding times for preparation or analysis exceeded
- ND Not Detected at the Reporting Limit
- PQL Practical Quantitative Limit
- S % Recovery outside of standard limits. If undiluted results may be estimated.
- B Analyte detected in the associated Method Blank
- E Above Quantitation Range/Estimated Value
- J Analyte detected below quantitation limits
- P Sample pH Not In Range
- RL Reporting Limit

QC SUMMARY REPORT

Hall Environmental Analysis Laboratory, Inc.

WO#: 2306300

28-Jun-23

Client: EA Engineering
Project: Dona Ana Dairies

Sample ID: MB-75701	SampType: MBLK	TestCode: SM 4500 Norg C: TKN								
Client ID: PBW	Batch ID: 75701	RunNo: 97569								
Prep Date: 6/19/2023	Analysis Date: 6/20/2023	SeqNo: 3547001	Units: mg/L							
Analyte	Result	PQL	SPK value	SPK Ref Val	%REC	LowLimit	HighLimit	%RPD	RPDLimit	Qual
Nitrogen, Kjeldahl, Total	ND	1.0								

Sample ID: LCS-75701	SampType: LCS	TestCode: SM 4500 Norg C: TKN								
Client ID: LCSW	Batch ID: 75701	RunNo: 97569								
Prep Date: 6/19/2023	Analysis Date: 6/20/2023	SeqNo: 3547002	Units: mg/L							
Analyte	Result	PQL	SPK value	SPK Ref Val	%REC	LowLimit	HighLimit	%RPD	RPDLimit	Qual
Nitrogen, Kjeldahl, Total	9.9	1.0	10.00	0	99.4	80	120			

Sample ID: MB-75797	SampType: MBLK	TestCode: SM 4500 Norg C: TKN								
Client ID: PBW	Batch ID: 75797	RunNo: 97692								
Prep Date: 6/22/2023	Analysis Date: 6/23/2023	SeqNo: 3552954	Units: mg/L							
Analyte	Result	PQL	SPK value	SPK Ref Val	%REC	LowLimit	HighLimit	%RPD	RPDLimit	Qual
Nitrogen, Kjeldahl, Total	ND	1.0								

Sample ID: LCS-75797	SampType: LCS	TestCode: SM 4500 Norg C: TKN								
Client ID: LCSW	Batch ID: 75797	RunNo: 97692								
Prep Date: 6/22/2023	Analysis Date: 6/23/2023	SeqNo: 3552955	Units: mg/L							
Analyte	Result	PQL	SPK value	SPK Ref Val	%REC	LowLimit	HighLimit	%RPD	RPDLimit	Qual
Nitrogen, Kjeldahl, Total	10	1.0	10.00	0	101	80	120			

Sample ID: MB-75790	SampType: MBLK	TestCode: SM 4500 Norg C: TKN								
Client ID: PBW	Batch ID: 75790	RunNo: 97725								
Prep Date: 6/22/2023	Analysis Date: 6/26/2023	SeqNo: 3554051	Units: mg/L							
Analyte	Result	PQL	SPK value	SPK Ref Val	%REC	LowLimit	HighLimit	%RPD	RPDLimit	Qual
Nitrogen, Kjeldahl, Total	ND	1.0								

Sample ID: LCS-75790	SampType: LCS	TestCode: SM 4500 Norg C: TKN								
Client ID: LCSW	Batch ID: 75790	RunNo: 97725								
Prep Date: 6/22/2023	Analysis Date: 6/26/2023	SeqNo: 3554052	Units: mg/L							
Analyte	Result	PQL	SPK value	SPK Ref Val	%REC	LowLimit	HighLimit	%RPD	RPDLimit	Qual
Nitrogen, Kjeldahl, Total	10	1.0	10.00	0	101	80	120			

Qualifiers:

- * Value exceeds Maximum Contaminant Level.
- D Sample Diluted Due to Matrix
- H Holding times for preparation or analysis exceeded
- ND Not Detected at the Reporting Limit
- PQL Practical Quantitative Limit
- S % Recovery outside of standard limits. If undiluted results may be estimated.
- B Analyte detected in the associated Method Blank
- E Above Quantitation Range/Estimated Value
- J Analyte detected below quantitation limits
- P Sample pH Not In Range
- RL Reporting Limit

Sample Log-In Check List

Client Name: EA Engineering

Work Order Number: 2306300

RcptNo: 1

Received By: Desiree Dominguez 6/7/2023 8:55:00 AM

DD

Completed By: Desiree Dominguez 6/7/2023 9:29:16 AM

DD

Reviewed By: *MD 6/7/23*

Chain of Custody

1. Is Chain of Custody complete? Yes No Not Present
2. How was the sample delivered? FedEx

Log In

3. Was an attempt made to cool the samples? Yes No NA
4. Were all samples received at a temperature of >0° C to 6.0°C Yes No NA
5. Sample(s) in proper container(s)? Yes No
6. Sufficient sample volume for indicated test(s)? Yes No
7. Are samples (except VOA and ONG) properly preserved? Yes No
8. Was preservative added to bottles? Yes No NA
9. Received at least 1 vial with headspace <1/4" for AQ VOA? Yes No NA
10. Were any sample containers received broken? Yes No
11. Does paperwork match bottle labels? Yes No
 (Note discrepancies on chain of custody)
12. Are matrices correctly identified on Chain of Custody? Yes No
13. Is it clear what analyses were requested? Yes No
14. Were all holding times able to be met? Yes No
 (If no, notify customer for authorization.)

of preserved bottles checked for pH: 5
 (2 or >12 unless noted)
 Adjusted? NO
 Checked by: *JL 6-7-23*

PH Strip lot # 538534

Special Handling (if applicable)

15. Was client notified of all discrepancies with this order? Yes No NA

Person Notified:	<input type="text"/>	Date:	<input type="text"/>
By Whom:	<input type="text"/>	Via:	<input type="checkbox"/> eMail <input type="checkbox"/> Phone <input type="checkbox"/> Fax <input type="checkbox"/> In Person
Regarding:	<input type="text"/>		
Client Instructions:	<input type="text"/>		

16. Additional remarks:

17. Cooler Information

Cooler No	Temp °C	Condition	Seal Intact	Seal No	Seal Date	Signed By
1	0.3	Good	Not Present	Yogi		

Chain-of-Custody Record

Client:

EA Engineering, Science, and Technology

Mailing Address:

320 Gold Ave SW Suite

Phone #: 505-715-4279

email or Fax#: rmullen@eaest.com

QA/QC Package:

Standard Level 4 (Full Validation)

Accreditation: Az Compliance

NELAC Other

EDD (Type)

Turn-Around Time:

Standard Rush

Project Name:

Dona Ana Dairies (DAD'S)

Project #:

Project Manager:

Gina Mullen

Sampler:

Angel N. Rivera

On Ice: Yes No

of Coolers: 1

Cooler Temp (including CF): 0.4 - 0.1 = 0.3°C

Container Type and #

Preservative Type

HEAL No. 2306300

Yog: -001

-002

-003

-004

-005

2

2

2

2

2

Date:

6-6

Time:

17:20

Relinquished by:

[Signature]

Received by:

[Signature]

Date:

6/7/23

Time:

8:55

Date:

6-6

Time:

[Signature]

Relinquished by:

[Signature]

Received by:

[Signature]

Date:

6/7/23

Time:

8:55

Remarks:

Via: FedEx

Remarks:

Analysis Request

Nitrate/Nitrites EPA Method 300	TKN SM 4500 NORG C	Chloride EPA 300	TDS SM 2540 C MOD	Sulfate EPA 300	Phosphorus EPA 6010B	Total Sulfur
X	X	X	X			
X	X	X	X			
X	X	X	X			
X	X	X	X			
X	X	X	X			

If necessary, samples submitted to Hall Environmental may be subcontracted to other accredited laboratories. This serves as notice of this possibility. Any sub-contracted data will be clearly notated on the analytical report.

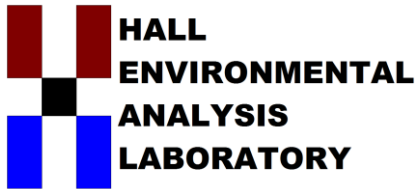

Hall Environmental Analysis Laboratory
4901 Hawkins NE
Albuquerque, NM 87109
TEL: 505-345-3975 FAX: 505-345-4107
Website: www.hallenvironmental.com

June 28, 2023

Regina Mullen
EA Engineering
320 Gold Ave SW Suite 1210
Albuquerque, NM 87102
TEL:
FAX:

RE: Mountain View Dairy

OrderNo.: 2306567

Dear Regina Mullen:

Hall Environmental Analysis Laboratory received 1 sample(s) on 6/10/2023 for the analyses presented in the following report.

These were analyzed according to EPA procedures or equivalent. To access our accredited tests please go to www.hallenvironmental.com or the state specific web sites. In order to properly interpret your results, it is imperative that you review this report in its entirety. See the sample checklist and/or the Chain of Custody for information regarding the sample receipt temperature and preservation. Data qualifiers or a narrative will be provided if the sample analysis or analytical quality control parameters require a flag. When necessary, data qualifiers are provided on both the sample analysis report and the QC summary report, both sections should be reviewed. All samples are reported, as received, unless otherwise indicated. Lab measurement of analytes considered field parameters that require analysis within 15 minutes of sampling such as pH and residual chlorine are qualified as being analyzed outside of the recommended holding time.

Please don't hesitate to contact HEAL for any additional information or clarifications.

ADHS Cert #AZ0682 -- NMED-DWB Cert #NM9425 -- NMED-Micro Cert #NM0901

Sincerely,

A handwritten signature in black ink, appearing to read 'Andy Freeman', is written in a cursive style.

Andy Freeman
Laboratory Manager
4901 Hawkins NE
Albuquerque, NM 87109

Hall Environmental Analysis Laboratory, Inc.

Analytical Report

Lab Order 2306567

Date Reported: 6/28/2023

CLIENT: EA Engineering

Client Sample ID: 70-Lagoon

Project: Mountain View Dairy

Collection Date: 6/9/2023 4:21:00 PM

Lab ID: 2306567-001

Matrix: AQUEOUS

Received Date: 6/10/2023 9:35:00 AM

Analyses	Result	RL	Qual	Units	DF	Date Analyzed	Batch
EPA METHOD 300.0: ANIONS							Analyst: JMT
Chloride	1400	50	*	mg/L	100	6/14/2023 12:03:23 AM	R97426
Nitrate+Nitrite as N	3.8	2.0		mg/L	10	6/14/2023 3:20:55 AM	R97426
SM2540C MOD: TOTAL DISSOLVED SOLIDS							Analyst: JAG
Total Dissolved Solids	7900	5000	*D	mg/L	1	6/19/2023 4:35:00 PM	75650
SM 4500 NORG C: TKN							Analyst: DML
Nitrogen, Kjeldahl, Total	880	10	D	mg/L	1	6/23/2023 8:55:00 AM	75797
EPA METHOD 200.7: TOTAL METALS							Analyst: JRR
Sulfur	260	10	D	mg/L	1	6/19/2023 1:16:27 PM	75552

Refer to the QC Summary report and sample login checklist for flagged QC data and preservation information.

Qualifiers:	*	Value exceeds Maximum Contaminant Level.	B	Analyte detected in the associated Method Blank
	D	Sample Diluted Due to Matrix	E	Above Quantitation Range/Estimated Value
	H	Holding times for preparation or analysis exceeded	J	Analyte detected below quantitation limits
	ND	Not Detected at the Reporting Limit	P	Sample pH Not In Range
	PQL	Practical Quantitative Limit	RL	Reporting Limit
	S	% Recovery outside of standard limits. If undiluted results may be estimated.		

QC SUMMARY REPORT

Hall Environmental Analysis Laboratory, Inc.

WO#: 2306567

28-Jun-23

Client: EA Engineering
Project: Mountain View Dairy

Sample ID: MB-75552	SampType: MBLK	TestCode: EPA Method 200.7: Total Metals								
Client ID: PBW	Batch ID: 75552	RunNo: 97552								
Prep Date: 6/13/2023	Analysis Date: 6/19/2023	SeqNo: 3545677	Units: mg/L							
Analyte	Result	PQL	SPK value	SPK Ref Val	%REC	LowLimit	HighLimit	%RPD	RPDLimit	Qual
Sulfur	ND	1.0								

Sample ID: LCSLL-75552	SampType: LCSLL	TestCode: EPA Method 200.7: Total Metals								
Client ID: BatchQC	Batch ID: 75552	RunNo: 97552								
Prep Date: 6/13/2023	Analysis Date: 6/19/2023	SeqNo: 3545678	Units: mg/L							
Analyte	Result	PQL	SPK value	SPK Ref Val	%REC	LowLimit	HighLimit	%RPD	RPDLimit	Qual
Sulfur	1.0	1.0	1.000	0	100	50	150			

Sample ID: LCS-75552	SampType: LCS	TestCode: EPA Method 200.7: Total Metals								
Client ID: LCSW	Batch ID: 75552	RunNo: 97552								
Prep Date: 6/13/2023	Analysis Date: 6/19/2023	SeqNo: 3545679	Units: mg/L							
Analyte	Result	PQL	SPK value	SPK Ref Val	%REC	LowLimit	HighLimit	%RPD	RPDLimit	Qual
Sulfur	50	1.0	50.00	0	99.3	85	115			

Qualifiers:

- | | |
|---|---|
| * Value exceeds Maximum Contaminant Level. | B Analyte detected in the associated Method Blank |
| D Sample Diluted Due to Matrix | E Above Quantitation Range/Estimated Value |
| H Holding times for preparation or analysis exceeded | J Analyte detected below quantitation limits |
| ND Not Detected at the Reporting Limit | P Sample pH Not In Range |
| PQL Practical Quantitative Limit | RL Reporting Limit |
| S % Recovery outside of standard limits. If undiluted results may be estimated. | |

QC SUMMARY REPORT

Hall Environmental Analysis Laboratory, Inc.

WO#: 2306567

28-Jun-23

Client: EA Engineering
Project: Mountain View Dairy

Sample ID: MB	SampType: mblk	TestCode: EPA Method 300.0: Anions								
Client ID: PBW	Batch ID: R97426	RunNo: 97426								
Prep Date:	Analysis Date: 6/13/2023	SeqNo: 3539669	Units: mg/L							
Analyte	Result	PQL	SPK value	SPK Ref Val	%REC	LowLimit	HighLimit	%RPD	RPDLimit	Qual
Chloride	ND	0.50								
Nitrate+Nitrite as N	ND	0.20								

Sample ID: LCS	SampType: lcs	TestCode: EPA Method 300.0: Anions								
Client ID: LCSW	Batch ID: R97426	RunNo: 97426								
Prep Date:	Analysis Date: 6/13/2023	SeqNo: 3539670	Units: mg/L							
Analyte	Result	PQL	SPK value	SPK Ref Val	%REC	LowLimit	HighLimit	%RPD	RPDLimit	Qual
Chloride	4.6	0.50	5.000	0	91.4	90	110			
Nitrate+Nitrite as N	3.4	0.20	3.500	0	96.6	90	110			

Qualifiers:

- * Value exceeds Maximum Contaminant Level.
- D Sample Diluted Due to Matrix
- H Holding times for preparation or analysis exceeded
- ND Not Detected at the Reporting Limit
- PQL Practical Quantitative Limit
- S % Recovery outside of standard limits. If undiluted results may be estimated.
- B Analyte detected in the associated Method Blank
- E Above Quantitation Range/Estimated Value
- J Analyte detected below quantitation limits
- P Sample pH Not In Range
- RL Reporting Limit

QC SUMMARY REPORT

Hall Environmental Analysis Laboratory, Inc.

WO#: 2306567

28-Jun-23

Client: EA Engineering
Project: Mountain View Dairy

Sample ID: MB-75650	SampType: MBLK	TestCode: SM2540C MOD: Total Dissolved Solids								
Client ID: PBW	Batch ID: 75650	RunNo: 97555								
Prep Date: 6/16/2023	Analysis Date: 6/19/2023	SeqNo: 3545893	Units: mg/L							
Analyte	Result	PQL	SPK value	SPK Ref Val	%REC	LowLimit	HighLimit	%RPD	RPDLimit	Qual
Total Dissolved Solids	ND	50.0								

Sample ID: LCS-75650	SampType: LCS	TestCode: SM2540C MOD: Total Dissolved Solids								
Client ID: LCSW	Batch ID: 75650	RunNo: 97555								
Prep Date: 6/16/2023	Analysis Date: 6/19/2023	SeqNo: 3545894	Units: mg/L							
Analyte	Result	PQL	SPK value	SPK Ref Val	%REC	LowLimit	HighLimit	%RPD	RPDLimit	Qual
Total Dissolved Solids	1000	50.0	1000	0	100	80	120			

Qualifiers:

- * Value exceeds Maximum Contaminant Level.
- D Sample Diluted Due to Matrix
- H Holding times for preparation or analysis exceeded
- ND Not Detected at the Reporting Limit
- PQL Practical Quantitative Limit
- S % Recovery outside of standard limits. If undiluted results may be estimated.
- B Analyte detected in the associated Method Blank
- E Above Quantitation Range/Estimated Value
- J Analyte detected below quantitation limits
- P Sample pH Not In Range
- RL Reporting Limit

QC SUMMARY REPORT

Hall Environmental Analysis Laboratory, Inc.

WO#: 2306567

28-Jun-23

Client: EA Engineering
Project: Mountain View Dairy

Sample ID: MB-75797	SampType: MBLK	TestCode: SM 4500 Norg C: TKN								
Client ID: PBW	Batch ID: 75797	RunNo: 97692								
Prep Date: 6/22/2023	Analysis Date: 6/23/2023	SeqNo: 3552954	Units: mg/L							
Analyte	Result	PQL	SPK value	SPK Ref Val	%REC	LowLimit	HighLimit	%RPD	RPDLimit	Qual
Nitrogen, Kjeldahl, Total	ND	1.0								

Sample ID: LCS-75797	SampType: LCS	TestCode: SM 4500 Norg C: TKN								
Client ID: LCSW	Batch ID: 75797	RunNo: 97692								
Prep Date: 6/22/2023	Analysis Date: 6/23/2023	SeqNo: 3552955	Units: mg/L							
Analyte	Result	PQL	SPK value	SPK Ref Val	%REC	LowLimit	HighLimit	%RPD	RPDLimit	Qual
Nitrogen, Kjeldahl, Total	10	1.0	10.00	0	101	80	120			

Qualifiers:

- * Value exceeds Maximum Contaminant Level.
- D Sample Diluted Due to Matrix
- H Holding times for preparation or analysis exceeded
- ND Not Detected at the Reporting Limit
- PQL Practical Quantitative Limit
- S % Recovery outside of standard limits. If undiluted results may be estimated.
- B Analyte detected in the associated Method Blank
- E Above Quantitation Range/Estimated Value
- J Analyte detected below quantitation limits
- P Sample pH Not In Range
- RL Reporting Limit

Sample Log-In Check List

Client Name: EA Engineering

Work Order Number: 2306567

RcptNo: 1

Received By: Juan Rojas 6/10/2023 9:35:00 AM *Juan Rojas*

Completed By: Desiree Dominguez 6/12/2023 8:30:10 AM *DD*

Reviewed By: *WJ 6/12/23*

Chain of Custody

1. Is Chain of Custody complete? Yes No Not Present
2. How was the sample delivered? Client

Log In

3. Was an attempt made to cool the samples? Yes No NA
4. Were all samples received at a temperature of >0° C to 6.0°C Yes No NA
5. Sample(s) in proper container(s)? Yes No
6. Sufficient sample volume for indicated test(s)? Yes No
7. Are samples (except VOA and ONG) properly preserved? Yes No
8. Was preservative added to bottles? Yes No NA
9. Received at least 1 vial with headspace <1/4" for AQ VOA? Yes No NA
10. Were any sample containers received broken? Yes No
11. Does paperwork match bottle labels? Yes No
 (Note discrepancies on chain of custody)
12. Are matrices correctly identified on Chain of Custody? Yes No
13. Is it clear what analyses were requested? Yes No
14. Were all holding times able to be met? Yes No
 (If no, notify customer for authorization.)

of preserved bottles checked for pH: 2
 (<2 or >12 unless noted)
 Adjusted? YES
 Checked by: SCM 06/12/23
pH Lot # 538534

Special Handling (if applicable)

15. Was client notified of all discrepancies with this order? Yes No NA

Person Notified:	<input type="text"/>	Date:	<input type="text"/>
By Whom:	<input type="text"/>	Via:	<input type="checkbox"/> eMail <input type="checkbox"/> Phone <input type="checkbox"/> Fax <input type="checkbox"/> In Person
Regarding:	<input type="text"/>		
Client Instructions:	<input type="text"/>		

16. Additional remarks: ADDED ~ 1 ML OF HNO₃ TO SAMPLE 6567-001B (Lot # 7162). ADDED ~ 1 ML OF H₂SO₄ TO SAMPLE 6567-001A (Lot # 6893). SCM 06/12/23

17. Cooler Information

Cooler No	Temp °C	Condition	Seal Intact	Seal No	Seal Date	Signed By
1	0.4	Good	Not Present	Yogi		



Hall Environmental Analysis Laboratory
4901 Hawkins NE
Albuquerque, NM 87109
TEL: 505-345-3975 FAX: 505-345-4107
Website: www.hallenvironmental.com

June 30, 2023

Regina Mullen
EA Engineering
320 Gold Ave SW Suite 1210
Albuquerque, NM 87102
TEL:
FAX:

RE: Sunset Dairy

OrderNo.: 2306568

Dear Regina Mullen:

Hall Environmental Analysis Laboratory received 1 sample(s) on 6/10/2023 for the analyses presented in the following report.

These were analyzed according to EPA procedures or equivalent. To access our accredited tests please go to www.hallenvironmental.com or the state specific web sites. In order to properly interpret your results, it is imperative that you review this report in its entirety. See the sample checklist and/or the Chain of Custody for information regarding the sample receipt temperature and preservation. Data qualifiers or a narrative will be provided if the sample analysis or analytical quality control parameters require a flag. When necessary, data qualifiers are provided on both the sample analysis report and the QC summary report, both sections should be reviewed. All samples are reported, as received, unless otherwise indicated. Lab measurement of analytes considered field parameters that require analysis within 15 minutes of sampling such as pH and residual chlorine are qualified as being analyzed outside of the recommended holding time.

Please don't hesitate to contact HEAL for any additional information or clarifications.

ADHS Cert #AZ0682 -- NMED-DWB Cert #NM9425 -- NMED-Micro Cert #NM0901

Sincerely,

A handwritten signature in black ink, appearing to read 'Andy Freeman', written in a cursive style.

Andy Freeman
Laboratory Manager
4901 Hawkins NE
Albuquerque, NM 87109

Hall Environmental Analysis Laboratory, Inc.

Analytical Report

Lab Order 2306568

Date Reported: 6/30/2023

CLIENT: EA Engineering

Client Sample ID: 257-Lagoon

Project: Sunset Dairy

Collection Date: 6/9/2023 3:07:00 PM

Lab ID: 2306568-001

Matrix: AQUEOUS

Received Date: 6/10/2023 9:35:00 AM

Analyses	Result	RL	Qual	Units	DF	Date Analyzed	Batch
EPA METHOD 300.0: ANIONS							Analyst: JMT
Chloride	1500	50	*	mg/L	100	6/14/2023 12:28:05 AM	R97426
Nitrate+Nitrite as N	ND	2.0		mg/L	10	6/14/2023 3:33:15 AM	R97426
SM2540C MOD: TOTAL DISSOLVED SOLIDS							Analyst: JAG
Total Dissolved Solids	7100	5000	*D	mg/L	1	6/19/2023 4:35:00 PM	75650
SM 4500 NORG C: TKN							Analyst: DML
Nitrogen, Kjeldahl, Total	2700	20	D	mg/L	1	6/29/2023 1:49:00 PM	75890
EPA METHOD 200.7: TOTAL METALS							Analyst: JRR
Sulfur	170	10	D	mg/L	1	6/19/2023 1:19:53 PM	75581

Refer to the QC Summary report and sample login checklist for flagged QC data and preservation information.

Qualifiers:	*	Value exceeds Maximum Contaminant Level.	B	Analyte detected in the associated Method Blank
	D	Sample Diluted Due to Matrix	E	Above Quantitation Range/Estimated Value
	H	Holding times for preparation or analysis exceeded	J	Analyte detected below quantitation limits
	ND	Not Detected at the Reporting Limit	P	Sample pH Not In Range
	PQL	Practical Quantitative Limit	RL	Reporting Limit
	S	% Recovery outside of standard limits. If undiluted results may be estimated.		

QC SUMMARY REPORT

Hall Environmental Analysis Laboratory, Inc.

WO#: 2306568

30-Jun-23

Client: EA Engineering
Project: Sunset Dairy

Sample ID: MB-75581	SampType: MBLK	TestCode: EPA Method 200.7: Total Metals								
Client ID: PBW	Batch ID: 75581	RunNo: 97552								
Prep Date: 6/14/2023	Analysis Date: 6/19/2023	SeqNo: 3545683	Units: mg/L							
Analyte	Result	PQL	SPK value	SPK Ref Val	%REC	LowLimit	HighLimit	%RPD	RPDLimit	Qual
Sulfur	ND	1.0								

Sample ID: LCSLL-75581	SampType: LCSLL	TestCode: EPA Method 200.7: Total Metals								
Client ID: BatchQC	Batch ID: 75581	RunNo: 97552								
Prep Date: 6/14/2023	Analysis Date: 6/19/2023	SeqNo: 3545688	Units: mg/L							
Analyte	Result	PQL	SPK value	SPK Ref Val	%REC	LowLimit	HighLimit	%RPD	RPDLimit	Qual
Sulfur	1.0	1.0	1.000	0	103	50	150			

Sample ID: LCS-75581	SampType: LCS	TestCode: EPA Method 200.7: Total Metals								
Client ID: LCSW	Batch ID: 75581	RunNo: 97552								
Prep Date: 6/14/2023	Analysis Date: 6/19/2023	SeqNo: 3545689	Units: mg/L							
Analyte	Result	PQL	SPK value	SPK Ref Val	%REC	LowLimit	HighLimit	%RPD	RPDLimit	Qual
Sulfur	52	1.0	50.00	0	104	85	115			

Qualifiers:

- * Value exceeds Maximum Contaminant Level.
- D Sample Diluted Due to Matrix
- H Holding times for preparation or analysis exceeded
- ND Not Detected at the Reporting Limit
- PQL Practical Quantitative Limit
- S % Recovery outside of standard limits. If undiluted results may be estimated.
- B Analyte detected in the associated Method Blank
- E Above Quantitation Range/Estimated Value
- J Analyte detected below quantitation limits
- P Sample pH Not In Range
- RL Reporting Limit

QC SUMMARY REPORT

Hall Environmental Analysis Laboratory, Inc.

WO#: 2306568

30-Jun-23

Client: EA Engineering
Project: Sunset Dairy

Sample ID: MB	SampType: mblk	TestCode: EPA Method 300.0: Anions								
Client ID: PBW	Batch ID: R97426	RunNo: 97426								
Prep Date:	Analysis Date: 6/13/2023	SeqNo: 3539669	Units: mg/L							
Analyte	Result	PQL	SPK value	SPK Ref Val	%REC	LowLimit	HighLimit	%RPD	RPDLimit	Qual
Chloride	ND	0.50								
Nitrate+Nitrite as N	ND	0.20								

Sample ID: LCS	SampType: lcs	TestCode: EPA Method 300.0: Anions								
Client ID: LCSW	Batch ID: R97426	RunNo: 97426								
Prep Date:	Analysis Date: 6/13/2023	SeqNo: 3539670	Units: mg/L							
Analyte	Result	PQL	SPK value	SPK Ref Val	%REC	LowLimit	HighLimit	%RPD	RPDLimit	Qual
Chloride	4.6	0.50	5.000	0	91.4	90	110			
Nitrate+Nitrite as N	3.4	0.20	3.500	0	96.6	90	110			

Qualifiers:

- | | |
|---|---|
| * Value exceeds Maximum Contaminant Level. | B Analyte detected in the associated Method Blank |
| D Sample Diluted Due to Matrix | E Above Quantitation Range/Estimated Value |
| H Holding times for preparation or analysis exceeded | J Analyte detected below quantitation limits |
| ND Not Detected at the Reporting Limit | P Sample pH Not In Range |
| PQL Practical Quantitative Limit | RL Reporting Limit |
| S % Recovery outside of standard limits. If undiluted results may be estimated. | |

QC SUMMARY REPORT

Hall Environmental Analysis Laboratory, Inc.

WO#: 2306568

30-Jun-23

Client: EA Engineering
Project: Sunset Dairy

Sample ID: MB-75650	SampType: MBLK	TestCode: SM2540C MOD: Total Dissolved Solids								
Client ID: PBW	Batch ID: 75650	RunNo: 97555								
Prep Date: 6/16/2023	Analysis Date: 6/19/2023	SeqNo: 3545893	Units: mg/L							
Analyte	Result	PQL	SPK value	SPK Ref Val	%REC	LowLimit	HighLimit	%RPD	RPDLimit	Qual
Total Dissolved Solids	ND	50.0								

Sample ID: LCS-75650	SampType: LCS	TestCode: SM2540C MOD: Total Dissolved Solids								
Client ID: LCSW	Batch ID: 75650	RunNo: 97555								
Prep Date: 6/16/2023	Analysis Date: 6/19/2023	SeqNo: 3545894	Units: mg/L							
Analyte	Result	PQL	SPK value	SPK Ref Val	%REC	LowLimit	HighLimit	%RPD	RPDLimit	Qual
Total Dissolved Solids	1000	50.0	1000	0	100	80	120			

Qualifiers:

- * Value exceeds Maximum Contaminant Level.
- D Sample Diluted Due to Matrix
- H Holding times for preparation or analysis exceeded
- ND Not Detected at the Reporting Limit
- PQL Practical Quantitative Limit
- S % Recovery outside of standard limits. If undiluted results may be estimated.
- B Analyte detected in the associated Method Blank
- E Above Quantitation Range/Estimated Value
- J Analyte detected below quantitation limits
- P Sample pH Not In Range
- RL Reporting Limit

QC SUMMARY REPORT

Hall Environmental Analysis Laboratory, Inc.

WO#: 2306568

30-Jun-23

Client: EA Engineering
Project: Sunset Dairy

Sample ID: MB-75890	SampType: MBLK	TestCode: SM 4500 Norg C: TKN								
Client ID: PBW	Batch ID: 75890	RunNo: 97828								
Prep Date: 6/28/2023	Analysis Date: 6/29/2023	SeqNo: 3558264	Units: mg/L							
Analyte	Result	PQL	SPK value	SPK Ref Val	%REC	LowLimit	HighLimit	%RPD	RPDLimit	Qual
Nitrogen, Kjeldahl, Total	ND	1.0								

Sample ID: LCS-75890	SampType: LCS	TestCode: SM 4500 Norg C: TKN								
Client ID: LCSW	Batch ID: 75890	RunNo: 97828								
Prep Date: 6/28/2023	Analysis Date: 6/29/2023	SeqNo: 3558265	Units: mg/L							
Analyte	Result	PQL	SPK value	SPK Ref Val	%REC	LowLimit	HighLimit	%RPD	RPDLimit	Qual
Nitrogen, Kjeldahl, Total	10	1.0	10.00	0	102	80	120			

Qualifiers:

- * Value exceeds Maximum Contaminant Level.
- D Sample Diluted Due to Matrix
- H Holding times for preparation or analysis exceeded
- ND Not Detected at the Reporting Limit
- PQL Practical Quantitative Limit
- S % Recovery outside of standard limits. If undiluted results may be estimated.
- B Analyte detected in the associated Method Blank
- E Above Quantitation Range/Estimated Value
- J Analyte detected below quantitation limits
- P Sample pH Not In Range
- RL Reporting Limit

Sample Log-In Check List

Client Name: EA Engineering

Work Order Number: 2306568

RcptNo: 1

Received By: Juan Rojas 6/10/2023 9:35:00 AM *Juan Rojas*

Completed By: Desiree Dominguez 6/12/2023 8:38:25 AM *DD*

Reviewed By: *[Signature] 6/12/23*

Chain of Custody

1. Is Chain of Custody complete? Yes No Not Present

2. How was the sample delivered? Client

Log In

3. Was an attempt made to cool the samples? Yes No NA

4. Were all samples received at a temperature of >0° C to 6.0°C Yes No NA

5. Sample(s) in proper container(s)? Yes No

6. Sufficient sample volume for indicated test(s)? Yes No

7. Are samples (except VOA and ONG) properly preserved? Yes No

8. Was preservative added to bottles? Yes No NA

9. Received at least 1 vial with headspace <1/4" for AQ VOA? Yes No NA

10. Were any sample containers received broken? Yes No

11. Does paperwork match bottle labels? (Note discrepancies on chain of custody) Yes No

12. Are matrices correctly identified on Chain of Custody? Yes No

13. Is it clear what analyses were requested? Yes No

14. Were all holding times able to be met? (If no, notify customer for authorization.) Yes No

of preserved bottles checked for pH: 2
 (<2 or >12 unless noted)
 Adjusted? YES
 Checked by: SCM 06/12/23

pt lot # 538534

Special Handling (if applicable)

15. Was client notified of all discrepancies with this order? Yes No NA

Person Notified:	<input type="text"/>	Date:	<input type="text"/>
By Whom:	<input type="text"/>	Via:	<input type="checkbox"/> eMail <input type="checkbox"/> Phone <input type="checkbox"/> Fax <input type="checkbox"/> In Person
Regarding:	<input type="text"/>		
Client Instructions:	<input type="text"/>		

16. Additional remarks: ADDED ~1.5 ML OF HNO3 TO SAMPLE 6568 001B. ADDED ~2.0 ML OF H2SO4 TO SAMPLE 6568-001A. (LOT#6893) SCM 06/12/23 (LOT#7162)

17. Cooler Information

Cooler No	Temp °C	Condition	Seal Intact	Seal No	Seal Date	Signed By
1	0.4	Good	Not Present	Yogi		

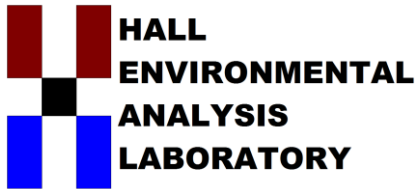

Hall Environmental Analysis Laboratory
4901 Hawkins NE
Albuquerque, NM 87109
TEL: 505-345-3975 FAX: 505-345-4107
Website: www.hallenvironmental.com

June 30, 2023

Regina Mullen
EA Engineering
320 Gold Ave SW Suite 1210
Albuquerque, NM 87102
TEL:
FAX:

RE: Big Sky Dairy

OrderNo.: 2306570

Dear Regina Mullen:

Hall Environmental Analysis Laboratory received 1 sample(s) on 6/10/2023 for the analyses presented in the following report.

These were analyzed according to EPA procedures or equivalent. To access our accredited tests please go to www.hallenvironmental.com or the state specific web sites. In order to properly interpret your results, it is imperative that you review this report in its entirety. See the sample checklist and/or the Chain of Custody for information regarding the sample receipt temperature and preservation. Data qualifiers or a narrative will be provided if the sample analysis or analytical quality control parameters require a flag. When necessary, data qualifiers are provided on both the sample analysis report and the QC summary report, both sections should be reviewed. All samples are reported, as received, unless otherwise indicated. Lab measurement of analytes considered field parameters that require analysis within 15 minutes of sampling such as pH and residual chlorine are qualified as being analyzed outside of the recommended holding time.

Please don't hesitate to contact HEAL for any additional information or clarifications.

ADHS Cert #AZ0682 -- NMED-DWB Cert #NM9425 -- NMED-Micro Cert #NM0901

Sincerely,

A handwritten signature in black ink, appearing to read 'Andy Freeman', written in a cursive style.

Andy Freeman
Laboratory Manager
4901 Hawkins NE
Albuquerque, NM 87109

Hall Environmental Analysis Laboratory, Inc.

Analytical Report

Lab Order 2306570

Date Reported: 6/30/2023

CLIENT: EA Engineering

Client Sample ID: 833- Lagoon

Project: Big Sky Dairy

Collection Date: 6/9/2023 2:00:00 PM

Lab ID: 2306570-001

Matrix: GROUNDWA

Received Date: 6/10/2023 9:35:00 AM

Analyses	Result	RL	Qual	Units	DF	Date Analyzed	Batch
EPA METHOD 300.0: ANIONS							Analyst: JMT
Chloride	1200	50	*	mg/L	100	6/13/2023 11:14:00 PM	R97426
Nitrate+Nitrite as N	ND	2.0		mg/L	10	6/14/2023 3:08:34 AM	R97426
SM2540C MOD: TOTAL DISSOLVED SOLIDS							Analyst: JAG
Total Dissolved Solids	6200	5000	*D	mg/L	1	6/19/2023 4:35:00 PM	75650
SM 4500 NORG C: TKN							Analyst: DML
Nitrogen, Kjeldahl, Total	2200	20	D	mg/L	1	6/29/2023 1:49:00 PM	75890
EPA METHOD 200.7: TOTAL METALS							Analyst: JRR
Sulfur	98	10	D	mg/L	1	6/19/2023 1:28:05 PM	75552

Refer to the QC Summary report and sample login checklist for flagged QC data and preservation information.

Qualifiers:	*	Value exceeds Maximum Contaminant Level.	B	Analyte detected in the associated Method Blank
	D	Sample Diluted Due to Matrix	E	Above Quantitation Range/Estimated Value
	H	Holding times for preparation or analysis exceeded	J	Analyte detected below quantitation limits
	ND	Not Detected at the Reporting Limit	P	Sample pH Not In Range
	PQL	Practical Quantitative Limit	RL	Reporting Limit
	S	% Recovery outside of standard limits. If undiluted results may be estimated.		

QC SUMMARY REPORT

Hall Environmental Analysis Laboratory, Inc.

WO#: 2306570

30-Jun-23

Client: EA Engineering
Project: Big Sky Dairy

Sample ID: MB-75552	SampType: MBLK	TestCode: EPA Method 200.7: Total Metals								
Client ID: PBW	Batch ID: 75552	RunNo: 97552								
Prep Date: 6/13/2023	Analysis Date: 6/19/2023	SeqNo: 3545677	Units: mg/L							
Analyte	Result	PQL	SPK value	SPK Ref Val	%REC	LowLimit	HighLimit	%RPD	RPDLimit	Qual
Sulfur	ND	1.0								

Sample ID: LCSLL-75552	SampType: LCSLL	TestCode: EPA Method 200.7: Total Metals								
Client ID: BatchQC	Batch ID: 75552	RunNo: 97552								
Prep Date: 6/13/2023	Analysis Date: 6/19/2023	SeqNo: 3545678	Units: mg/L							
Analyte	Result	PQL	SPK value	SPK Ref Val	%REC	LowLimit	HighLimit	%RPD	RPDLimit	Qual
Sulfur	1.0	1.0	1.000	0	100	50	150			

Sample ID: LCS-75552	SampType: LCS	TestCode: EPA Method 200.7: Total Metals								
Client ID: LCSW	Batch ID: 75552	RunNo: 97552								
Prep Date: 6/13/2023	Analysis Date: 6/19/2023	SeqNo: 3545679	Units: mg/L							
Analyte	Result	PQL	SPK value	SPK Ref Val	%REC	LowLimit	HighLimit	%RPD	RPDLimit	Qual
Sulfur	50	1.0	50.00	0	99.3	85	115			

Qualifiers:

- | | |
|---|---|
| * Value exceeds Maximum Contaminant Level. | B Analyte detected in the associated Method Blank |
| D Sample Diluted Due to Matrix | E Above Quantitation Range/Estimated Value |
| H Holding times for preparation or analysis exceeded | J Analyte detected below quantitation limits |
| ND Not Detected at the Reporting Limit | P Sample pH Not In Range |
| PQL Practical Quantitative Limit | RL Reporting Limit |
| S % Recovery outside of standard limits. If undiluted results may be estimated. | |

QC SUMMARY REPORT

Hall Environmental Analysis Laboratory, Inc.

WO#: 2306570

30-Jun-23

Client: EA Engineering
Project: Big Sky Dairy

Sample ID: MB	SampType: mblk	TestCode: EPA Method 300.0: Anions								
Client ID: PBW	Batch ID: R97426	RunNo: 97426								
Prep Date:	Analysis Date: 6/13/2023	SeqNo: 3539669	Units: mg/L							
Analyte	Result	PQL	SPK value	SPK Ref Val	%REC	LowLimit	HighLimit	%RPD	RPDLimit	Qual
Chloride	ND	0.50								
Nitrate+Nitrite as N	ND	0.20								

Sample ID: LCS	SampType: lcs	TestCode: EPA Method 300.0: Anions								
Client ID: LCSW	Batch ID: R97426	RunNo: 97426								
Prep Date:	Analysis Date: 6/13/2023	SeqNo: 3539670	Units: mg/L							
Analyte	Result	PQL	SPK value	SPK Ref Val	%REC	LowLimit	HighLimit	%RPD	RPDLimit	Qual
Chloride	4.6	0.50	5.000	0	91.4	90	110			
Nitrate+Nitrite as N	3.4	0.20	3.500	0	96.6	90	110			

Qualifiers:

- * Value exceeds Maximum Contaminant Level.
- D Sample Diluted Due to Matrix
- H Holding times for preparation or analysis exceeded
- ND Not Detected at the Reporting Limit
- PQL Practical Quantitative Limit
- S % Recovery outside of standard limits. If undiluted results may be estimated.
- B Analyte detected in the associated Method Blank
- E Above Quantitation Range/Estimated Value
- J Analyte detected below quantitation limits
- P Sample pH Not In Range
- RL Reporting Limit

QC SUMMARY REPORT

Hall Environmental Analysis Laboratory, Inc.

WO#: 2306570

30-Jun-23

Client: EA Engineering
Project: Big Sky Dairy

Sample ID: MB-75650	SampType: MBLK	TestCode: SM2540C MOD: Total Dissolved Solids								
Client ID: PBW	Batch ID: 75650	RunNo: 97555								
Prep Date: 6/16/2023	Analysis Date: 6/19/2023	SeqNo: 3545893	Units: mg/L							
Analyte	Result	PQL	SPK value	SPK Ref Val	%REC	LowLimit	HighLimit	%RPD	RPDLimit	Qual
Total Dissolved Solids	ND	50.0								

Sample ID: LCS-75650	SampType: LCS	TestCode: SM2540C MOD: Total Dissolved Solids								
Client ID: LCSW	Batch ID: 75650	RunNo: 97555								
Prep Date: 6/16/2023	Analysis Date: 6/19/2023	SeqNo: 3545894	Units: mg/L							
Analyte	Result	PQL	SPK value	SPK Ref Val	%REC	LowLimit	HighLimit	%RPD	RPDLimit	Qual
Total Dissolved Solids	1000	50.0	1000	0	100	80	120			

Qualifiers:

- * Value exceeds Maximum Contaminant Level.
- D Sample Diluted Due to Matrix
- H Holding times for preparation or analysis exceeded
- ND Not Detected at the Reporting Limit
- PQL Practical Quantitative Limit
- S % Recovery outside of standard limits. If undiluted results may be estimated.
- B Analyte detected in the associated Method Blank
- E Above Quantitation Range/Estimated Value
- J Analyte detected below quantitation limits
- P Sample pH Not In Range
- RL Reporting Limit

QC SUMMARY REPORT

Hall Environmental Analysis Laboratory, Inc.

WO#: 2306570

30-Jun-23

Client: EA Engineering
Project: Big Sky Dairy

Sample ID: MB-75890	SampType: MBLK	TestCode: SM 4500 Norg C: TKN								
Client ID: PBW	Batch ID: 75890	RunNo: 97828								
Prep Date: 6/28/2023	Analysis Date: 6/29/2023	SeqNo: 3558264	Units: mg/L							
Analyte	Result	PQL	SPK value	SPK Ref Val	%REC	LowLimit	HighLimit	%RPD	RPDLimit	Qual
Nitrogen, Kjeldahl, Total	ND	1.0								

Sample ID: LCS-75890	SampType: LCS	TestCode: SM 4500 Norg C: TKN								
Client ID: LCSW	Batch ID: 75890	RunNo: 97828								
Prep Date: 6/28/2023	Analysis Date: 6/29/2023	SeqNo: 3558265	Units: mg/L							
Analyte	Result	PQL	SPK value	SPK Ref Val	%REC	LowLimit	HighLimit	%RPD	RPDLimit	Qual
Nitrogen, Kjeldahl, Total	10	1.0	10.00	0	102	80	120			

Qualifiers:

- | | |
|---|---|
| * Value exceeds Maximum Contaminant Level. | B Analyte detected in the associated Method Blank |
| D Sample Diluted Due to Matrix | E Above Quantitation Range/Estimated Value |
| H Holding times for preparation or analysis exceeded | J Analyte detected below quantitation limits |
| ND Not Detected at the Reporting Limit | P Sample pH Not In Range |
| PQL Practical Quantitative Limit | RL Reporting Limit |
| S % Recovery outside of standard limits. If undiluted results may be estimated. | |

Sample Log-In Check List

Client Name: EA Engineering

Work Order Number: 2306570

RcptNo: 1

Received By: Juan Rojas 6/10/2023 9:35:00 AM

Juan Rojas

Completed By: Desiree Dominguez 6/12/2023 8:47:33 AM

DD

Reviewed By: *[Signature]* 6/12/23

Chain of Custody

1. Is Chain of Custody complete? Yes No Not Present
2. How was the sample delivered? Client

Log In

3. Was an attempt made to cool the samples? Yes No NA
4. Were all samples received at a temperature of >0° C to 6.0°C Yes No NA
5. Sample(s) in proper container(s)? Yes No
6. Sufficient sample volume for indicated test(s)? Yes No
7. Are samples (except VOA and ONG) properly preserved? Yes No
8. Was preservative added to bottles? Yes No NA
9. Received at least 1 vial with headspace <1/4" for AQ VOA? Yes No NA
10. Were any sample containers received broken? Yes No
11. Does paperwork match bottle labels? (Note discrepancies on chain of custody) Yes No
12. Are matrices correctly identified on Chain of Custody? Yes No
13. Is it clear what analyses were requested? Yes No
14. Were all holding times able to be met? (If no, notify customer for authorization.) Yes No

of preserved bottles checked for pH: 2
 (2 or >12 unless noted)
 Adjusted? YES
 Checked by: SCM 06/12/23

pH Lot #538531

Special Handling (if applicable)

15. Was client notified of all discrepancies with this order? Yes No NA

Person Notified: _____ Date: _____
 By Whom: _____ Via: eMail Phone Fax In Person
 Regarding: _____
 Client Instructions: _____

16. Additional remarks: *ADDED ~ 1.5 MLS OF HNO3 TO SAMPLE 6570-001B (LOT #7162) ADDED ~ 2.0 MLS OF SA OF H2SO4 (LOT #6893) TO SAMPLE 6570-001A. SCM 06/12/23*

17. Cooler Information

Cooler No	Temp °C	Condition	Seal Intact	Seal No	Seal Date	Signed By
1	0.4	Good	Not Present	Yogi		

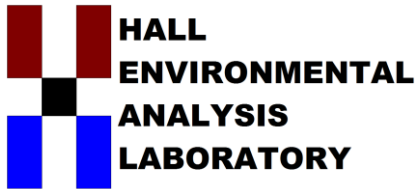

Hall Environmental Analysis Laboratory
4901 Hawkins NE
Albuquerque, NM 87109
TEL: 505-345-3975 FAX: 505-345-4107
Website: www.hallenvironmental.com

July 28, 2023

Regina Mullen
EA Engineering
320 Gold Ave SW Suite 1210
Albuquerque, NM 87102
TEL:
FAX:

RE: Big Sky Dairy

OrderNo.: 2307131

Dear Regina Mullen:

Hall Environmental Analysis Laboratory received 1 sample(s) on 7/6/2023 for the analyses presented in the following report.

These were analyzed according to EPA procedures or equivalent. To access our accredited tests please go to www.hallenvironmental.com or the state specific web sites. In order to properly interpret your results, it is imperative that you review this report in its entirety. See the sample checklist and/or the Chain of Custody for information regarding the sample receipt temperature and preservation. Data qualifiers or a narrative will be provided if the sample analysis or analytical quality control parameters require a flag. When necessary, data qualifiers are provided on both the sample analysis report and the QC summary report, both sections should be reviewed. All samples are reported, as received, unless otherwise indicated. Lab measurement of analytes considered field parameters that require analysis within 15 minutes of sampling such as pH and residual chlorine are qualified as being analyzed outside of the recommended holding time.

Please don't hesitate to contact HEAL for any additional information or clarifications.

ADHS Cert #AZ0682 -- NMED-DWB Cert #NM9425 -- NMED-Micro Cert #NM0901

Sincerely,

A handwritten signature in black ink, appearing to read "Andy Freeman", is written in a cursive style.

Andy Freeman
Laboratory Manager
4901 Hawkins NE
Albuquerque, NM 87109

Hall Environmental Analysis Laboratory, Inc.

Analytical Report

Lab Order 2307131

Date Reported: 7/28/2023

CLIENT: EA Engineering

Client Sample ID: 833-05

Project: Big Sky Dairy

Collection Date: 7/3/2023 10:15:00 AM

Lab ID: 2307131-001

Matrix: GROUNDWA

Received Date: 7/6/2023 8:45:00 AM

Analyses	Result	RL	Qual	Units	DF	Date Analyzed	Batch
EPA METHOD 300.0: ANIONS							Analyst: JTT
Chloride	1000	50	*	mg/L	100	7/7/2023 5:00:12 PM	R98016
Sulfate	430	50	*	mg/L	100	7/7/2023 5:00:12 PM	R98016
Nitrate+Nitrite as N	24	1.0	*	mg/L	5	7/7/2023 6:04:29 PM	R98016
SM2540C MOD: TOTAL DISSOLVED SOLIDS							Analyst: KS
Total Dissolved Solids	3120	250	*D	mg/L	1	7/9/2023 10:32:00 AM	76050
SM 4500 NORG C: TKN							Analyst: DML
Nitrogen, Kjeldahl, Total	ND	5.0	D	mg/L	1	7/27/2023 7:55:00 AM	76466

Refer to the QC Summary report and sample login checklist for flagged QC data and preservation information.

Qualifiers:	*	Value exceeds Maximum Contaminant Level.	B	Analyte detected in the associated Method Blank
	D	Sample Diluted Due to Matrix	E	Above Quantitation Range/Estimated Value
	H	Holding times for preparation or analysis exceeded	J	Analyte detected below quantitation limits
	ND	Not Detected at the Reporting Limit	P	Sample pH Not In Range
	PQL	Practical Quantitative Limit	RL	Reporting Limit
	S	% Recovery outside of standard limits. If undiluted results may be estimated.		

QC SUMMARY REPORT

Hall Environmental Analysis Laboratory, Inc.

WO#: 2307131

28-Jul-23

Client: EA Engineering
Project: Big Sky Dairy

Sample ID: MB	SampType: MBLK	TestCode: EPA Method 300.0: Anions
Client ID: PBW	Batch ID: R98016	RunNo: 98016
Prep Date:	Analysis Date: 7/7/2023	SeqNo: 3566283 Units: mg/L

Analyte	Result	PQL	SPK value	SPK Ref Val	%REC	LowLimit	HighLimit	%RPD	RPDLimit	Qual
Chloride	ND	0.50								
Sulfate	ND	0.50								
Nitrate+Nitrite as N	ND	0.20								

Sample ID: LCS	SampType: LCS	TestCode: EPA Method 300.0: Anions
Client ID: LCSW	Batch ID: R98016	RunNo: 98016
Prep Date:	Analysis Date: 7/7/2023	SeqNo: 3566284 Units: mg/L

Analyte	Result	PQL	SPK value	SPK Ref Val	%REC	LowLimit	HighLimit	%RPD	RPDLimit	Qual
Chloride	4.7	0.50	5.000	0	95.0	90	110			
Sulfate	9.8	0.50	10.00	0	98.0	90	110			
Nitrate+Nitrite as N	3.5	0.20	3.500	0	100	90	110			

Qualifiers:

- | | |
|---|---|
| * Value exceeds Maximum Contaminant Level. | B Analyte detected in the associated Method Blank |
| D Sample Diluted Due to Matrix | E Above Quantitation Range/Estimated Value |
| H Holding times for preparation or analysis exceeded | J Analyte detected below quantitation limits |
| ND Not Detected at the Reporting Limit | P Sample pH Not In Range |
| PQL Practical Quantitative Limit | RL Reporting Limit |
| S % Recovery outside of standard limits. If undiluted results may be estimated. | |

QC SUMMARY REPORT

Hall Environmental Analysis Laboratory, Inc.

WO#: 2307131

28-Jul-23

Client: EA Engineering

Project: Big Sky Dairy

Sample ID: MB-76050	SampType: MBLK	TestCode: SM2540C MOD: Total Dissolved Solids								
Client ID: PBW	Batch ID: 76050	RunNo: 98024								
Prep Date: 7/7/2023	Analysis Date: 7/9/2023	SeqNo: 3566596	Units: mg/L							
Analyte	Result	PQL	SPK value	SPK Ref Val	%REC	LowLimit	HighLimit	%RPD	RPDLimit	Qual
Total Dissolved Solids	ND	50.0								

Sample ID: LCS-76050	SampType: LCS	TestCode: SM2540C MOD: Total Dissolved Solids								
Client ID: LCSW	Batch ID: 76050	RunNo: 98024								
Prep Date: 7/7/2023	Analysis Date: 7/9/2023	SeqNo: 3566597	Units: mg/L							
Analyte	Result	PQL	SPK value	SPK Ref Val	%REC	LowLimit	HighLimit	%RPD	RPDLimit	Qual
Total Dissolved Solids	1040	50.0	1000	0	104	80	120			

Qualifiers:

* Value exceeds Maximum Contaminant Level.
D Sample Diluted Due to Matrix
H Holding times for preparation or analysis exceeded
ND Not Detected at the Reporting Limit
PQL Practical Quantitative Limit
S % Recovery outside of standard limits. If undiluted results may be estimated.

B Analyte detected in the associated Method Blank
E Above Quantitation Range/Estimated Value
J Analyte detected below quantitation limits
P Sample pH Not In Range
RL Reporting Limit

QC SUMMARY REPORT

Hall Environmental Analysis Laboratory, Inc.

WO#: 2307131

28-Jul-23

Client: EA Engineering
Project: Big Sky Dairy

Sample ID: MB-76466	SampType: MBLK	TestCode: SM 4500 Norg C: TKN								
Client ID: PBW	Batch ID: 76466	RunNo: 98530								
Prep Date: 7/26/2023	Analysis Date: 7/27/2023	SeqNo: 3587384	Units: mg/L							
Analyte	Result	PQL	SPK value	SPK Ref Val	%REC	LowLimit	HighLimit	%RPD	RPDLimit	Qual
Nitrogen, Kjeldahl, Total	ND	1.0								

Sample ID: LCS-76466	SampType: LCS	TestCode: SM 4500 Norg C: TKN								
Client ID: LCSW	Batch ID: 76466	RunNo: 98530								
Prep Date: 7/26/2023	Analysis Date: 7/27/2023	SeqNo: 3587385	Units: mg/L							
Analyte	Result	PQL	SPK value	SPK Ref Val	%REC	LowLimit	HighLimit	%RPD	RPDLimit	Qual
Nitrogen, Kjeldahl, Total	10	1.0	10.00	0	101	80	120			

Qualifiers:

- * Value exceeds Maximum Contaminant Level.
- D Sample Diluted Due to Matrix
- H Holding times for preparation or analysis exceeded
- ND Not Detected at the Reporting Limit
- PQL Practical Quantitative Limit
- S % Recovery outside of standard limits. If undiluted results may be estimated.
- B Analyte detected in the associated Method Blank
- E Above Quantitation Range/Estimated Value
- J Analyte detected below quantitation limits
- P Sample pH Not In Range
- RL Reporting Limit

Sample Log-In Check List

Client Name: EA Engineering

Work Order Number: 2307131

RcptNo: 1

Received By: Tracy Casarrubias 7/6/2023 8:45:00 AM

Completed By: Tracy Casarrubias 7/6/2023 12:04:56 PM

Reviewed By: *JH* 7-6-23

Chain of Custody

1. Is Chain of Custody complete? Yes No Not Present
2. How was the sample delivered? FedEx

Log In

3. Was an attempt made to cool the samples? Yes No NA
4. Were all samples received at a temperature of >0° C to 6.0°C Yes No NA
5. Sample(s) in proper container(s)? Yes No
6. Sufficient sample volume for indicated test(s)? Yes No
7. Are samples (except VOA and ONG) properly preserved? Yes No
8. Was preservative added to bottles? Yes No NA
9. Received at least 1 vial with headspace <1/4" for AQ VOA? Yes No NA
10. Were any sample containers received broken? Yes No
11. Does paperwork match bottle labels?
 (Note discrepancies on chain of custody) Yes No
12. Are matrices correctly identified on Chain of Custody? Yes No
13. Is it clear what analyses were requested? Yes No
14. Were all holding times able to be met?
 (If no, notify customer for authorization.) Yes No

of preserved bottles checked for pH: 1
 (<2 or >12 unless noted)

Adjusted? no

Checked by: Cue 7/6/23

Special Handling (if applicable)

15. Was client notified of all discrepancies with this order? Yes No NA

Person Notified: _____ Date: _____
 By Whom: _____ Via: eMail Phone Fax In Person
 Regarding: _____
 Client Instructions: _____

16. Additional remarks:

17. Cooler Information

Cooler No	Temp °C	Condition	Seal Intact	Seal No	Seal Date	Signed By
1	-0.3	Good	Not Present	Morty		

APPENDIX D
HYDROGRAPHS BY AREA

HYDROGRAPHS FOR SELECT DP MONITORING WELLS NORTHERN PORTION DONA ANA DAIRIES, DONA ANA COUNTY, NEW MEXICO

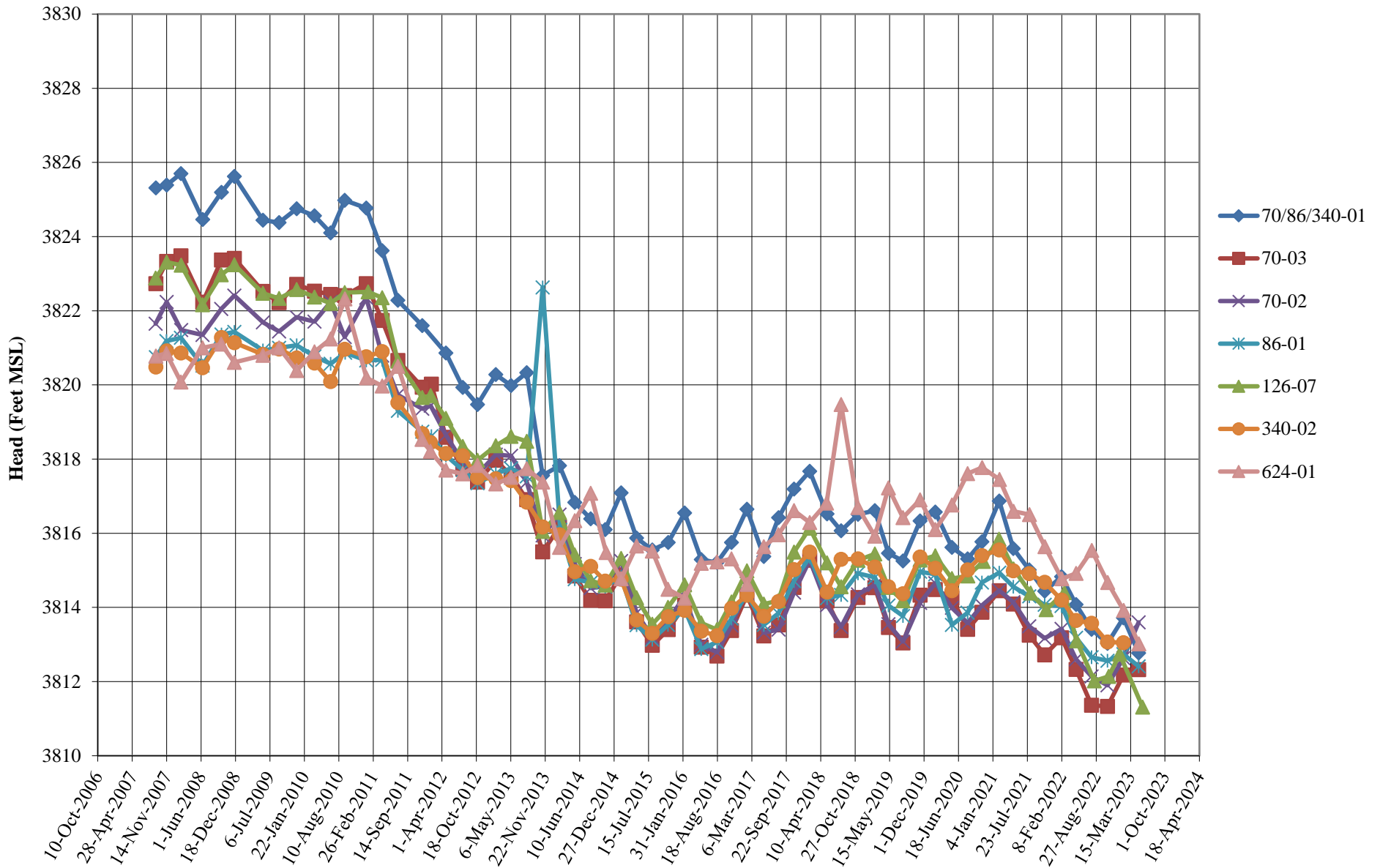

HYDROGRAPHS FOR DP MONITORING WELLS SOUTHERN PORTION DONA ANA DAIRIES, DONA ANA COUNTY, NEW MEXICO

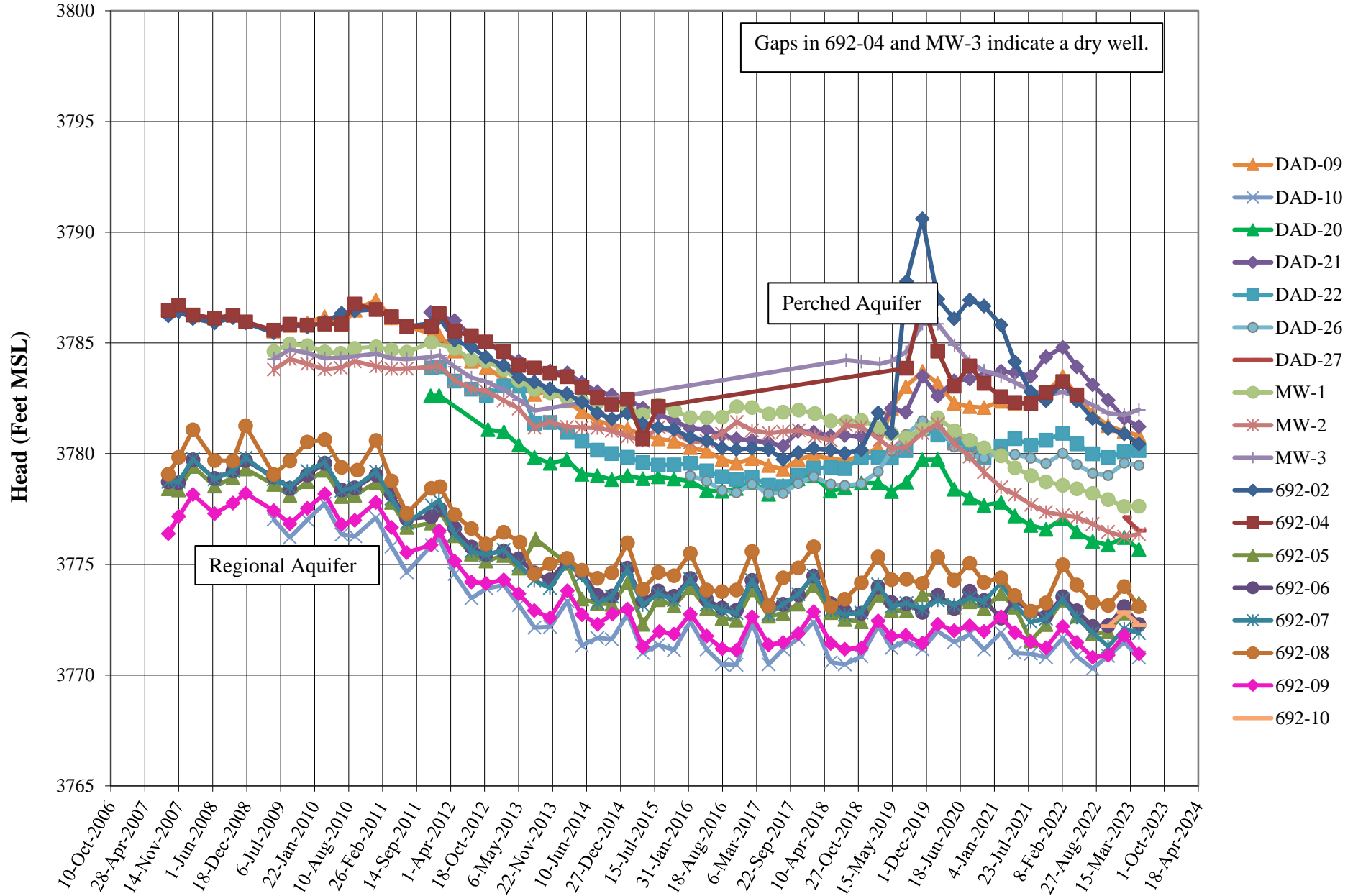

APPENDIX E
FIELD PARAMETER TRENDS BY AREA

SPECIFIC CONDUCTANCE TRENDS
NORTHERN AREA DISCHARGE PLAN MONITORING WELLS
DONA ANA DAIRIES, DONA ANA COUNTY, NEW MEXICO

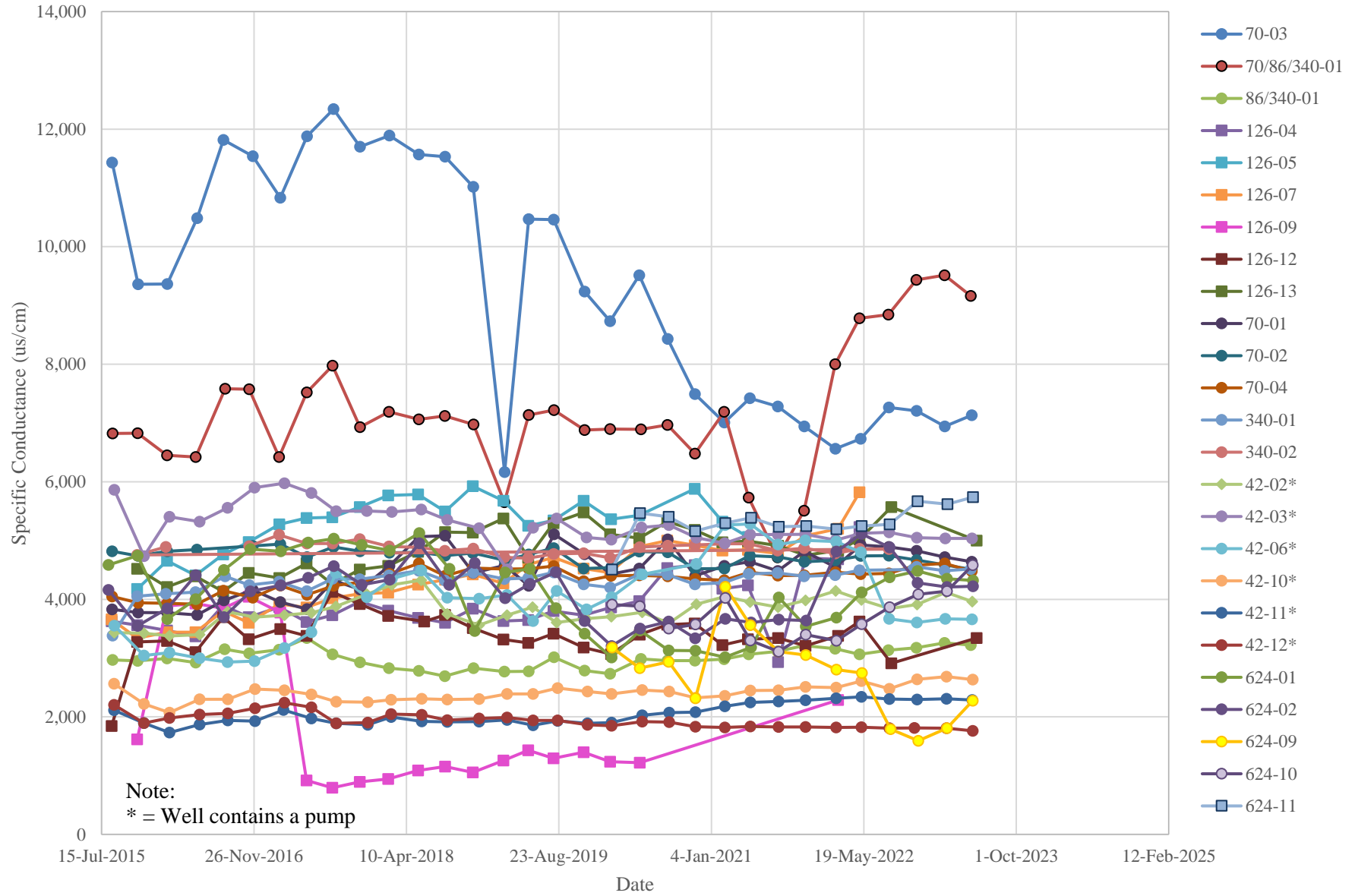

**DISSOLVED OXYGEN TRENDS
NORTHERN AREA DISCHARGE PLAN MONITORING WELLS
DONA ANA DAIRIES, DONA ANA COUNTY, NEW MEXICO**

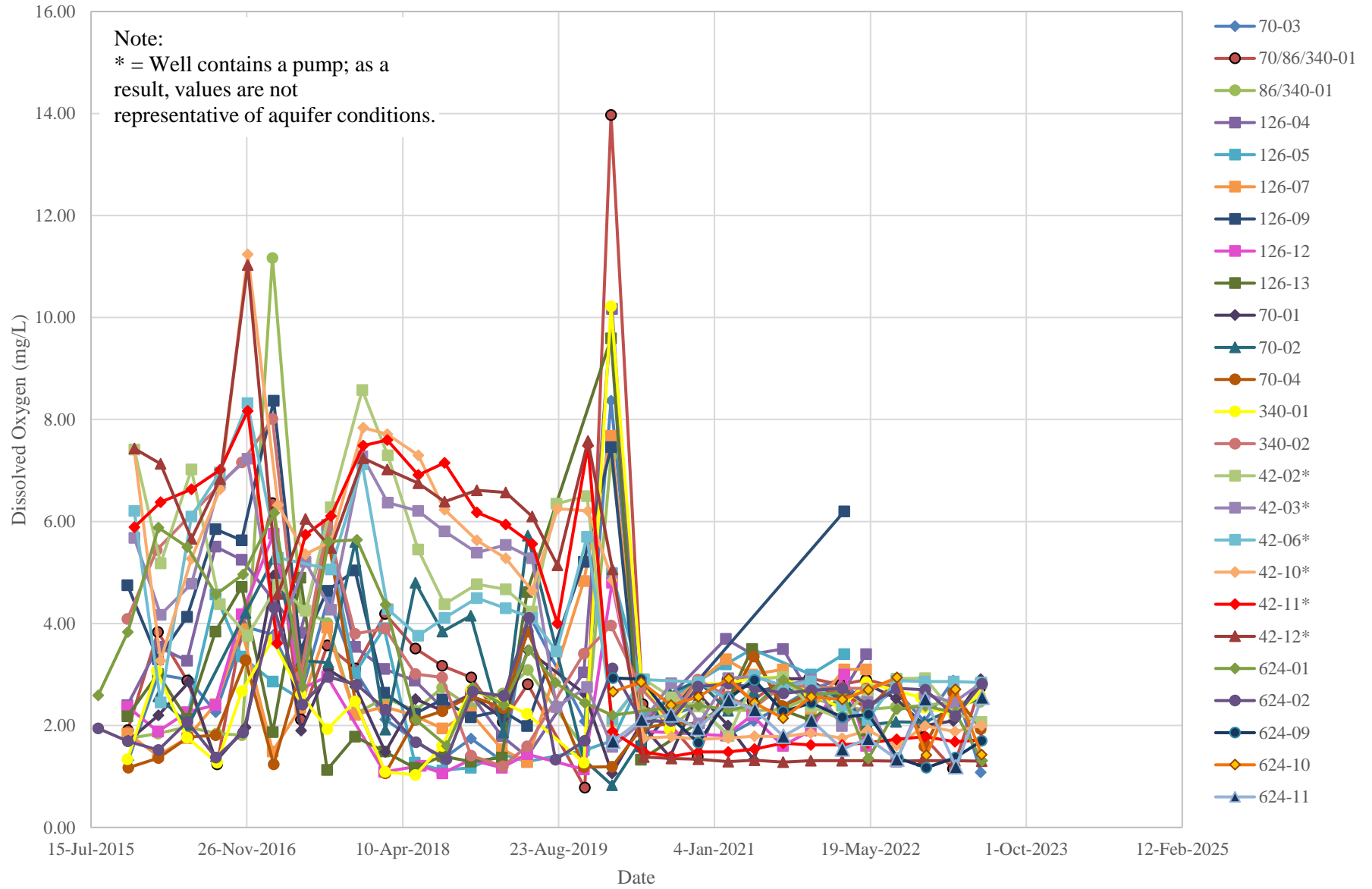

**OXIDATION-REDUCTION POTENTIAL TRENDS
NORTHERN AREA DISCHARGE PLAN MONITORING WELLS
DONA ANA DAIRIES, DONA ANA COUNTY, NEW MEXICO**

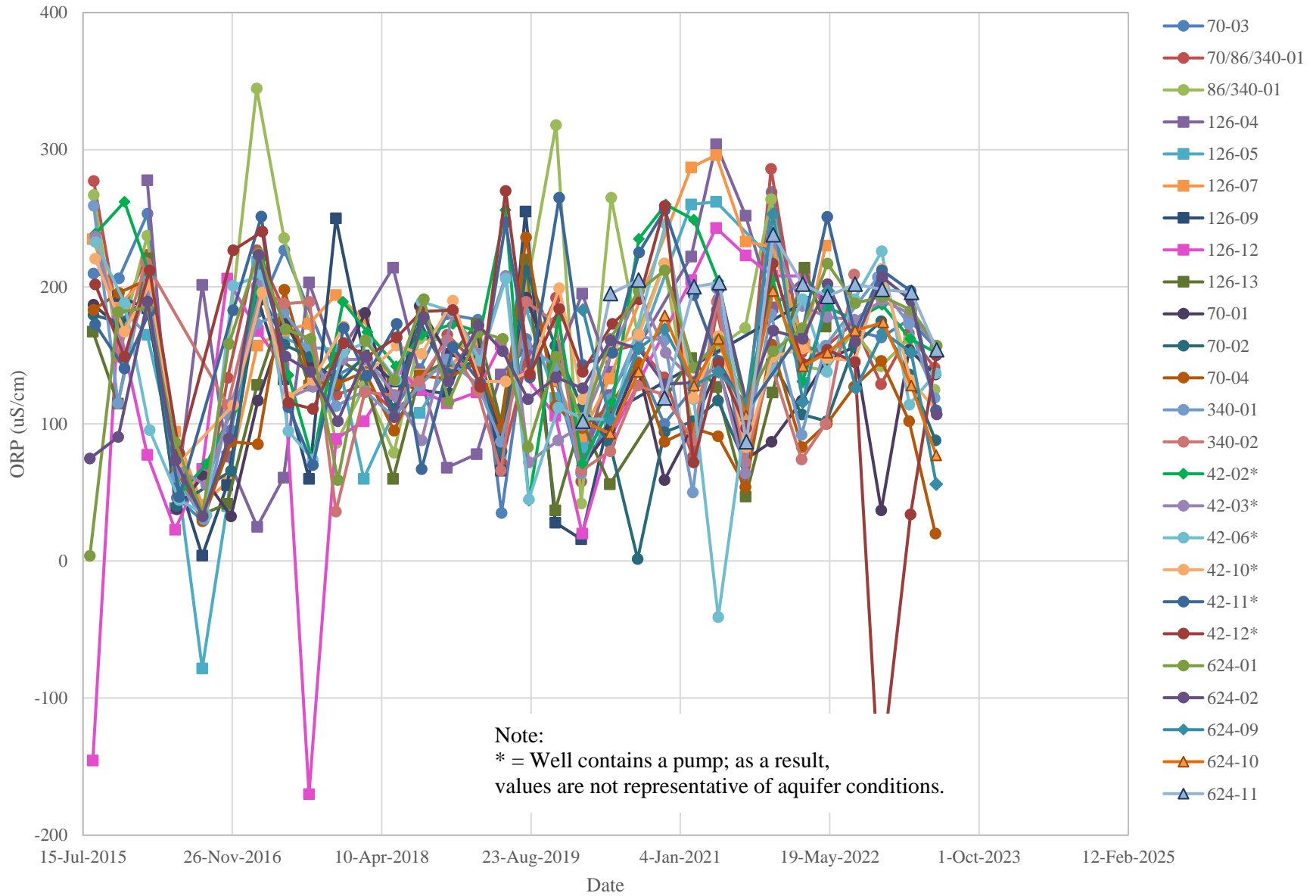

**SPECIFIC CONDUCTANCE TRENDS
CENTRAL AREA DISCHARGE PLAN MONITORING WELLS
DONA ANA DAIRIES, DONA ANA COUNTY, NEW MEXICO**

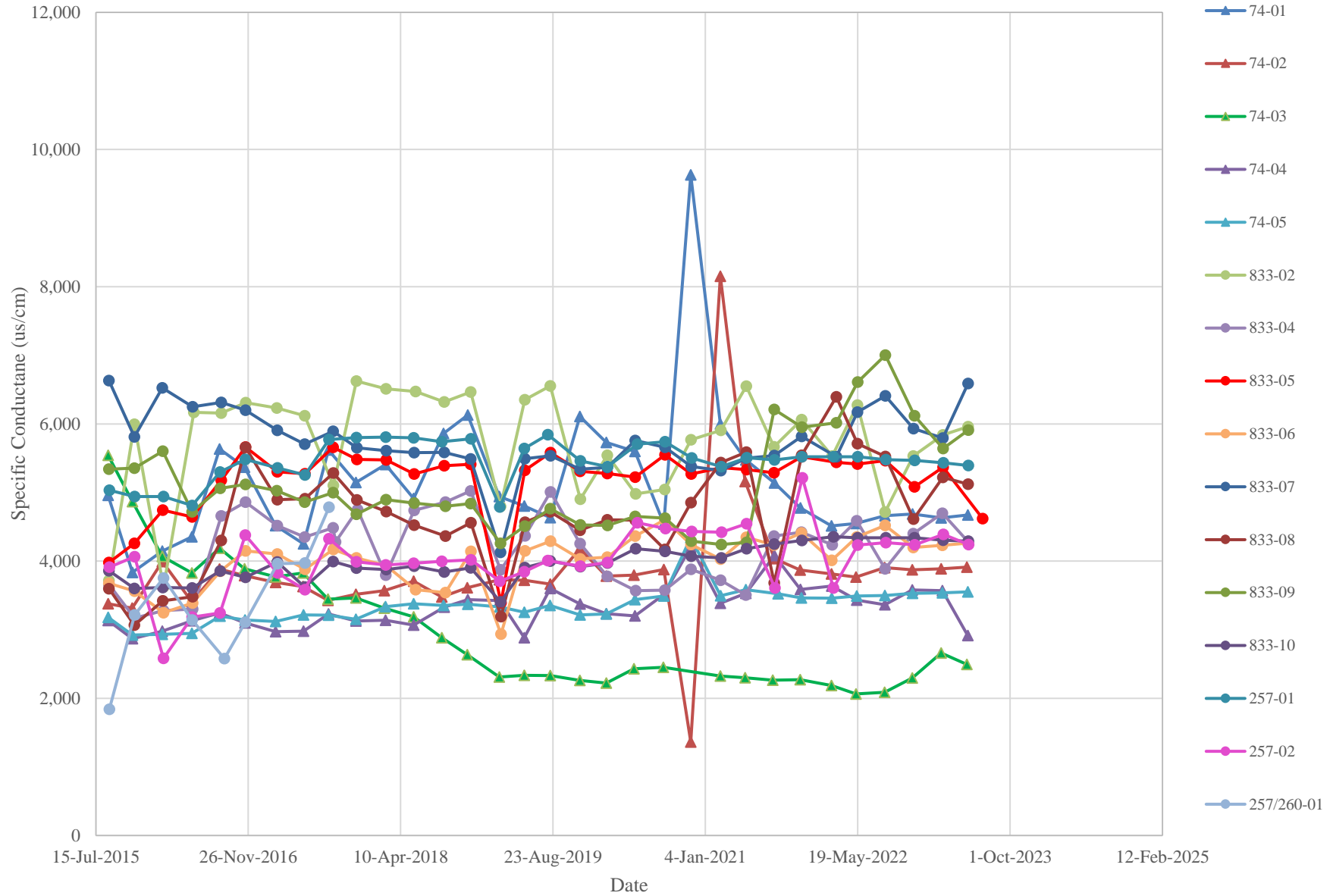

**DISSOLVED OXYGEN TRENDS
CENTRAL AREA DISCHARGE PLAN MONITORING WELLS
DONA ANA DAIRIES, DONA ANA COUNTY, NEW MEXICO**

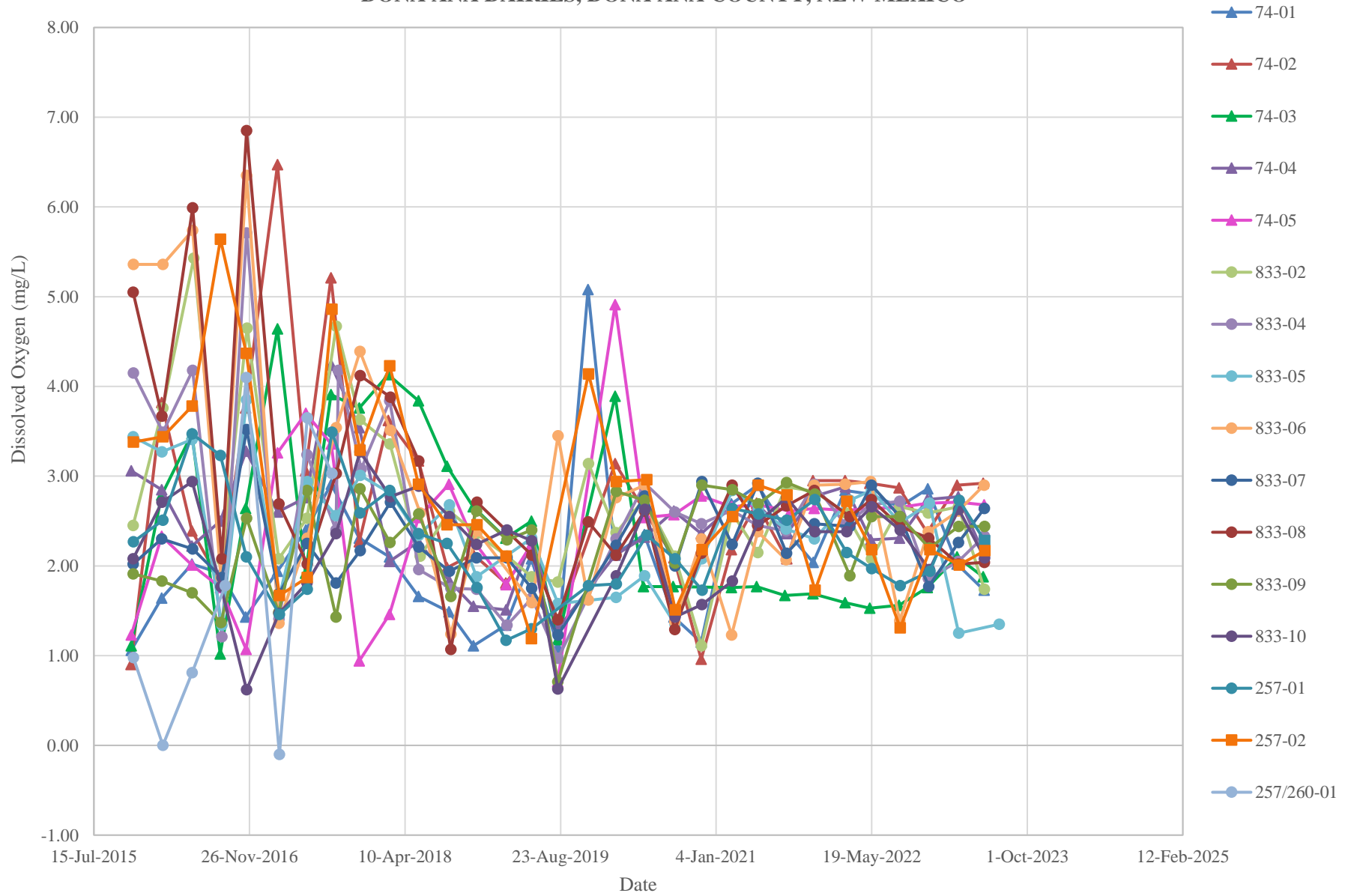

**OXIDATION-REDUCTION POTENTIAL TRENDS
CENTRAL AREA DISCHARGE PLAN MONITORING WELLS
DONA ANA DAIRIES, DONA ANA COUNTY, NEW MEXICO**

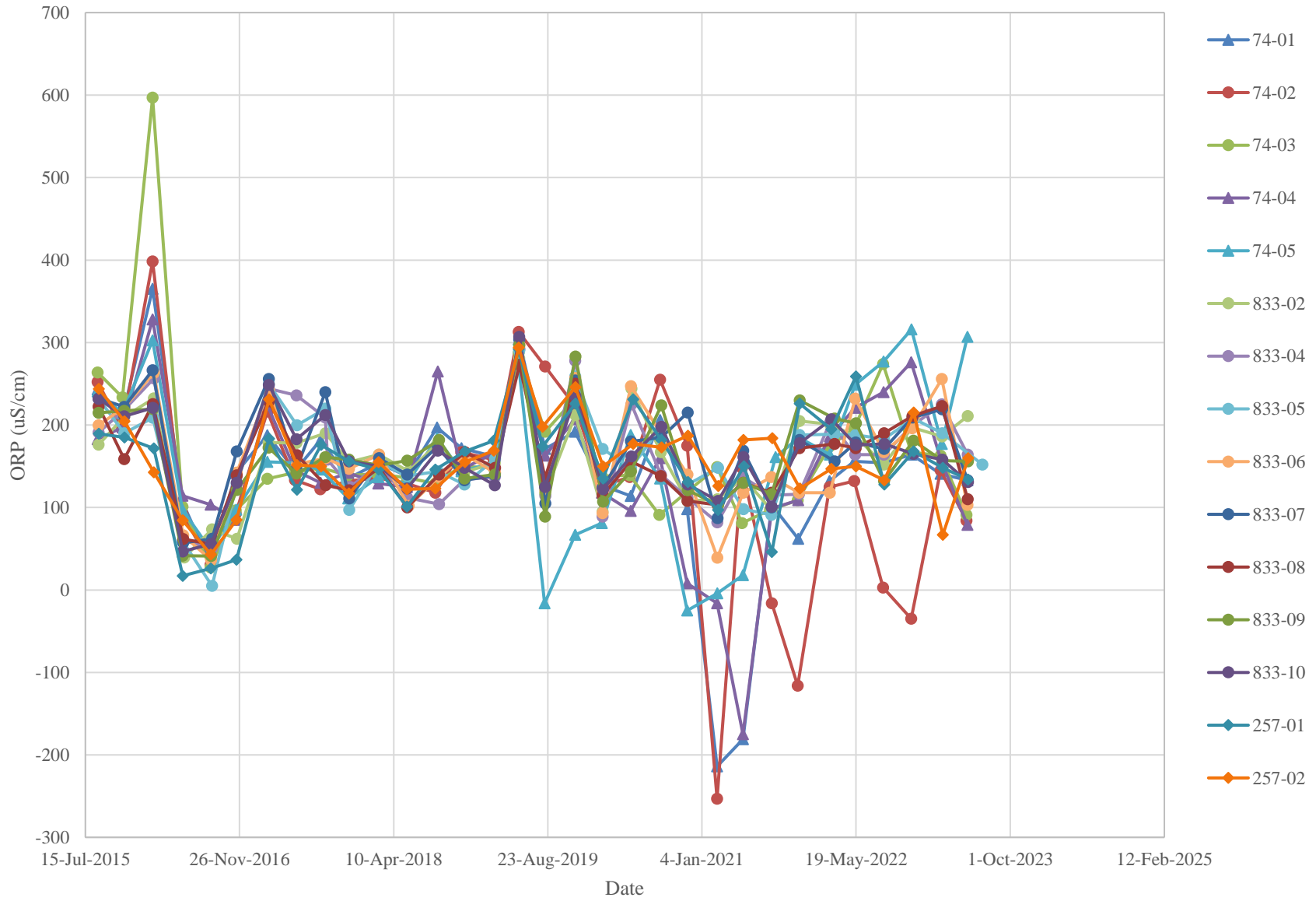

**SPECIFIC CONDUCTANCE TRENDS
SOUTHERN AREA DISCHARGE PLAN MONITORING WELLS
IN THE REGIONAL AQUIFER
DONA ANA DAIRIES, DONA ANA COUNTY, NEW MEXICO**

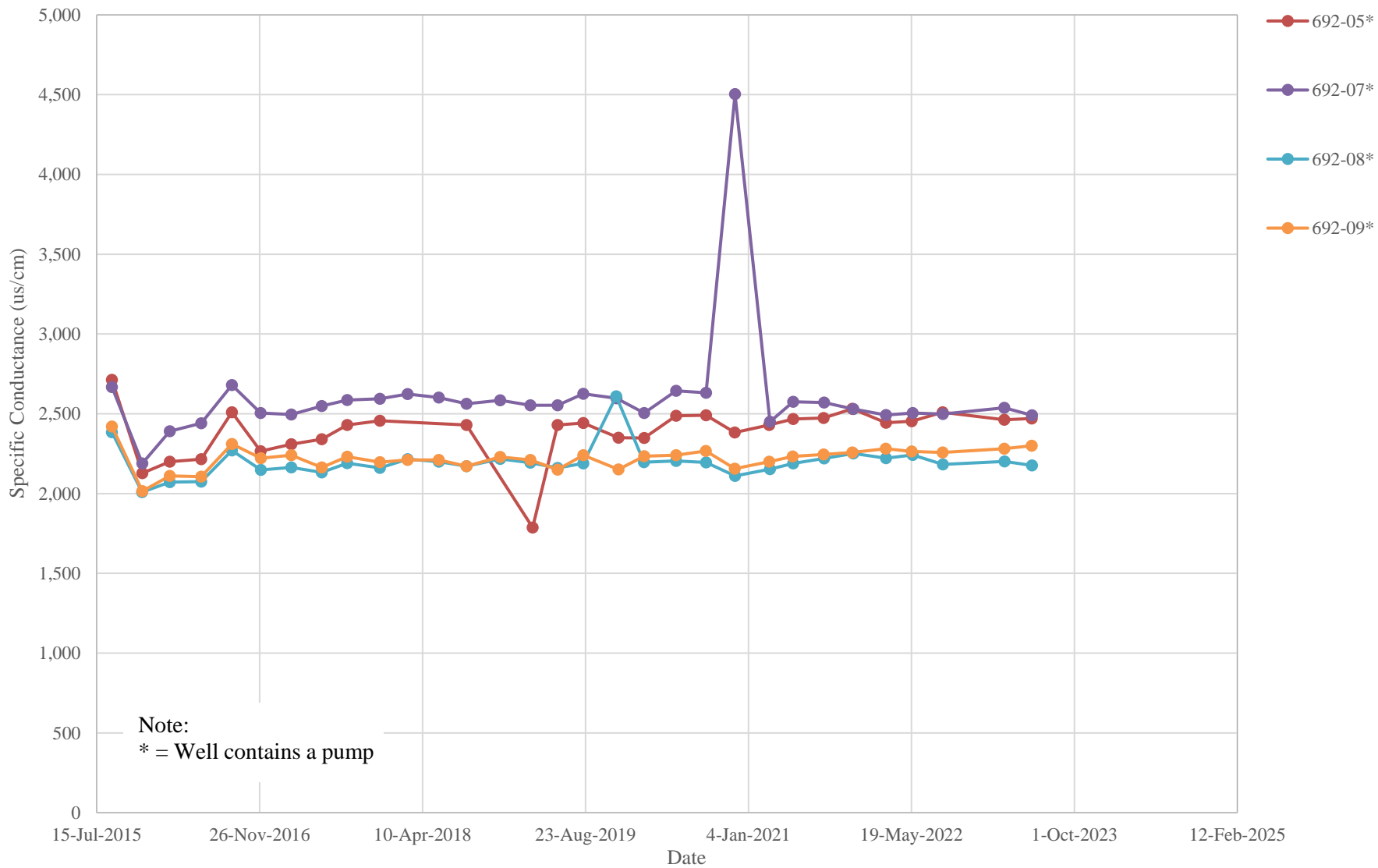

**SPECIFIC CONDUCTANCE TRENDS
SOUTHERN AREA DISCHARGE PLAN MONITORING WELLS
IN THE PERCHED AQUIFER
DONA ANA DAIRIES, DONA ANA COUNTY, NEW MEXICO**

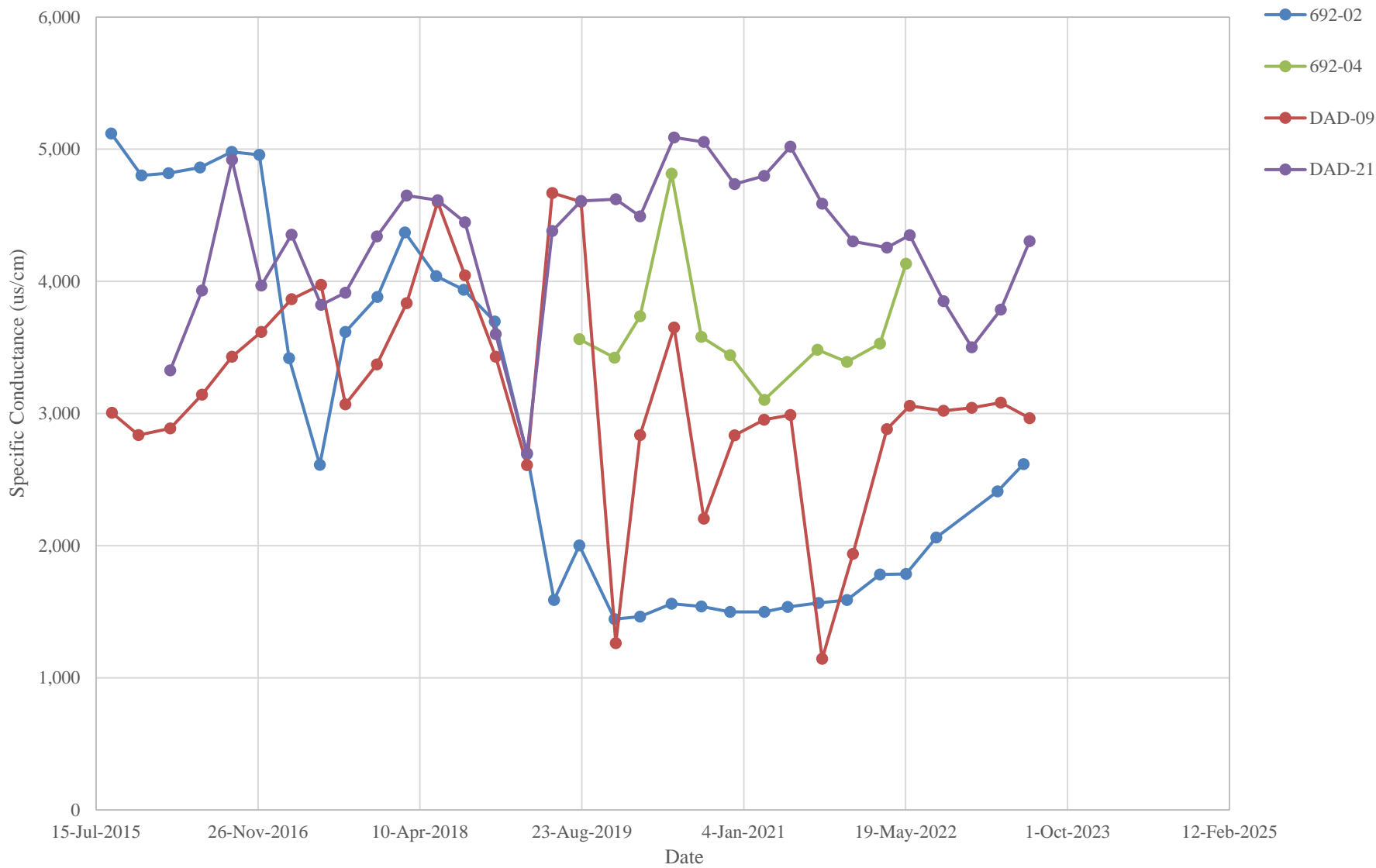

**DISSOLVED OXYGEN TRENDS
SOUTHERN AREA DISCHARGE PLAN MONITORING WELLS
DONA ANA DAIRIES, DONA ANA COUNTY, NEW MEXICO**

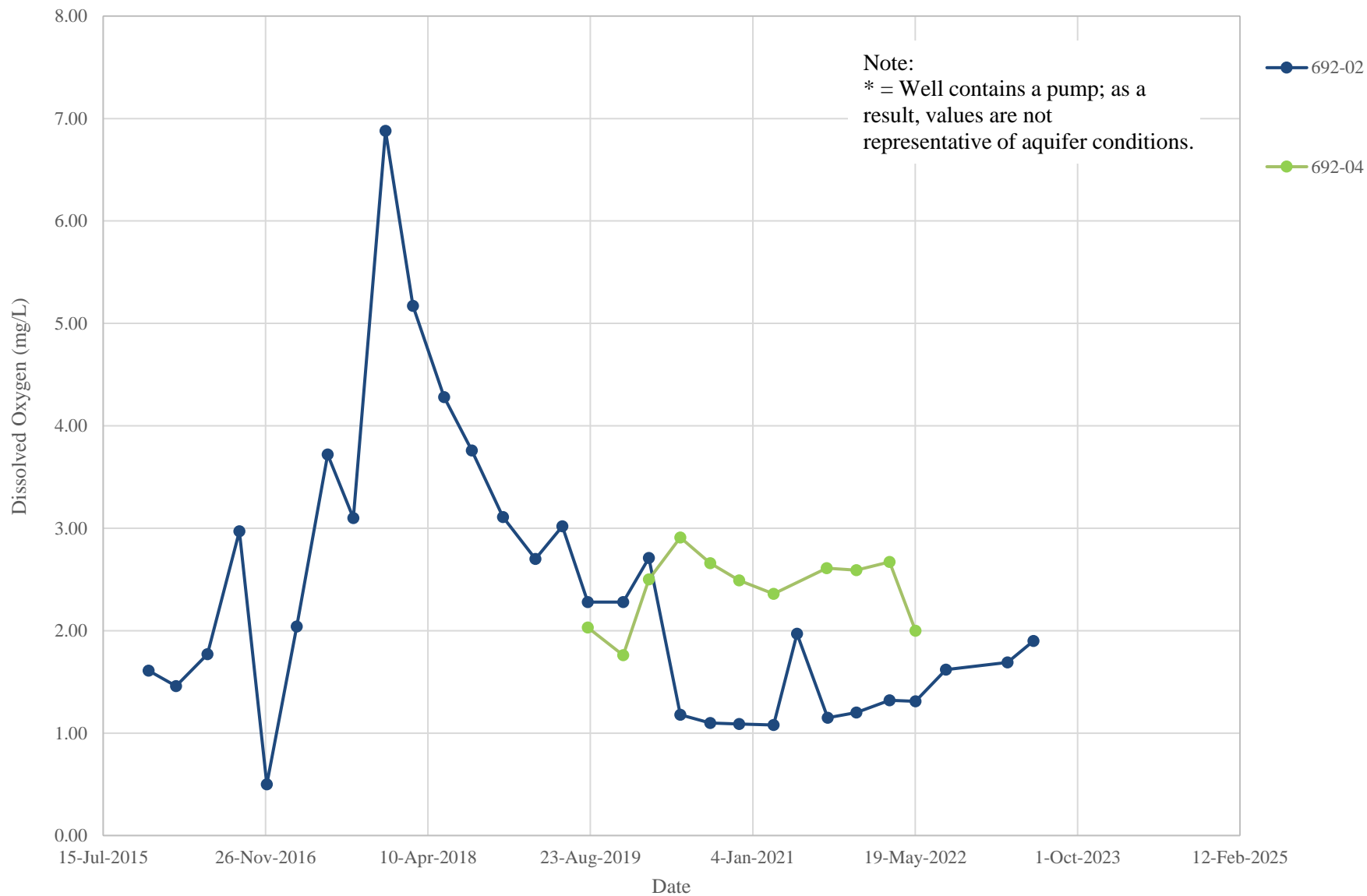

**OXIDATION-REDUCTION POTENTIAL TRENDS
SOUTHERN AREA DISCHARGE PLAN MONITORING WELLS
DONA ANA DAIRIES, DONA ANA COUNTY, NEW MEXICO**

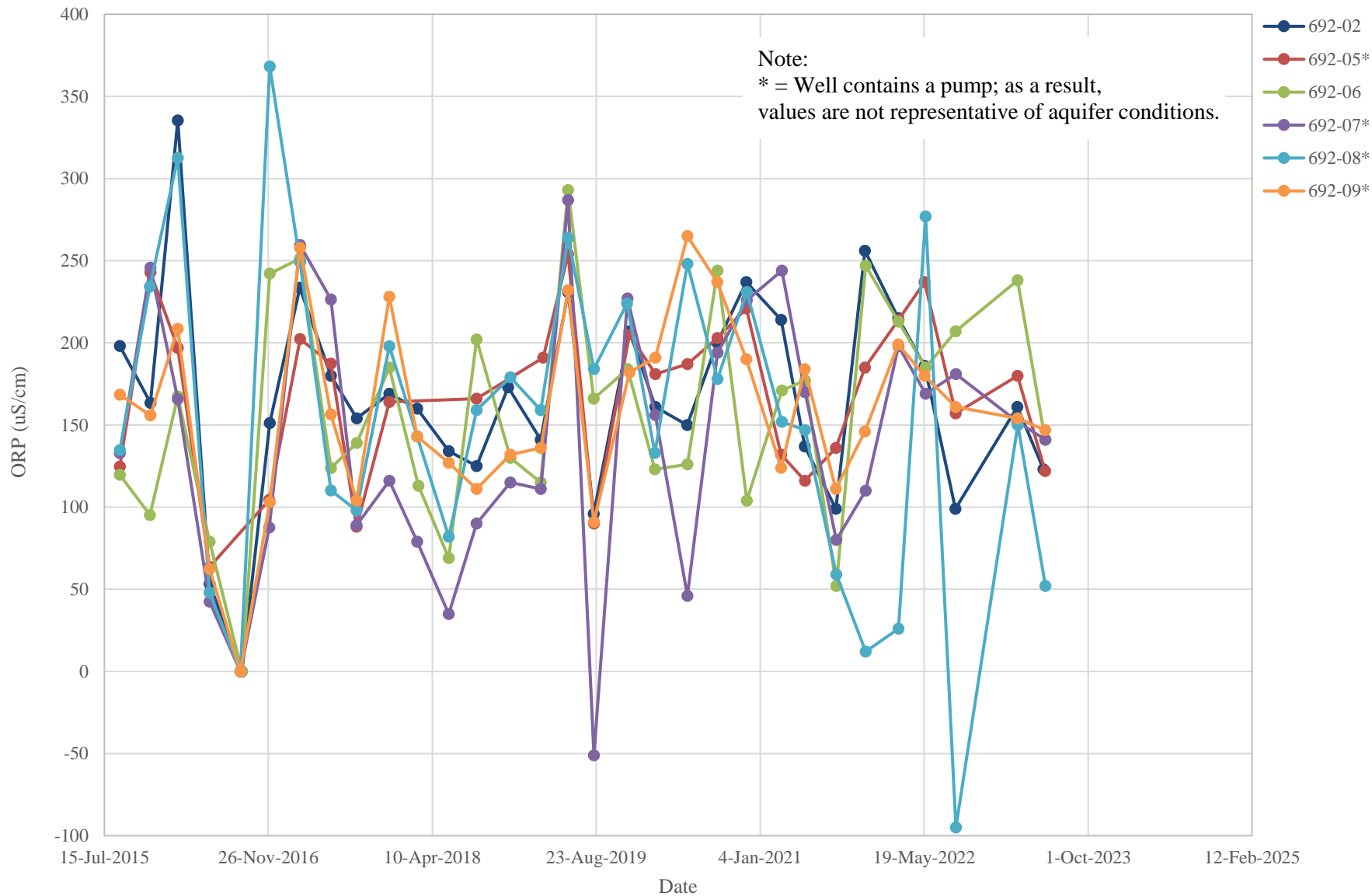

**OXIDATION-REDUCTION POTENTIAL TRENDS
SOUTHERN AREA DISCHARGE PLAN MONITORING WELLS
IN THE PERCHED AQUIFER
DONA ANA DAIRIES, DONA ANA COUNTY, NEW MEXICO**

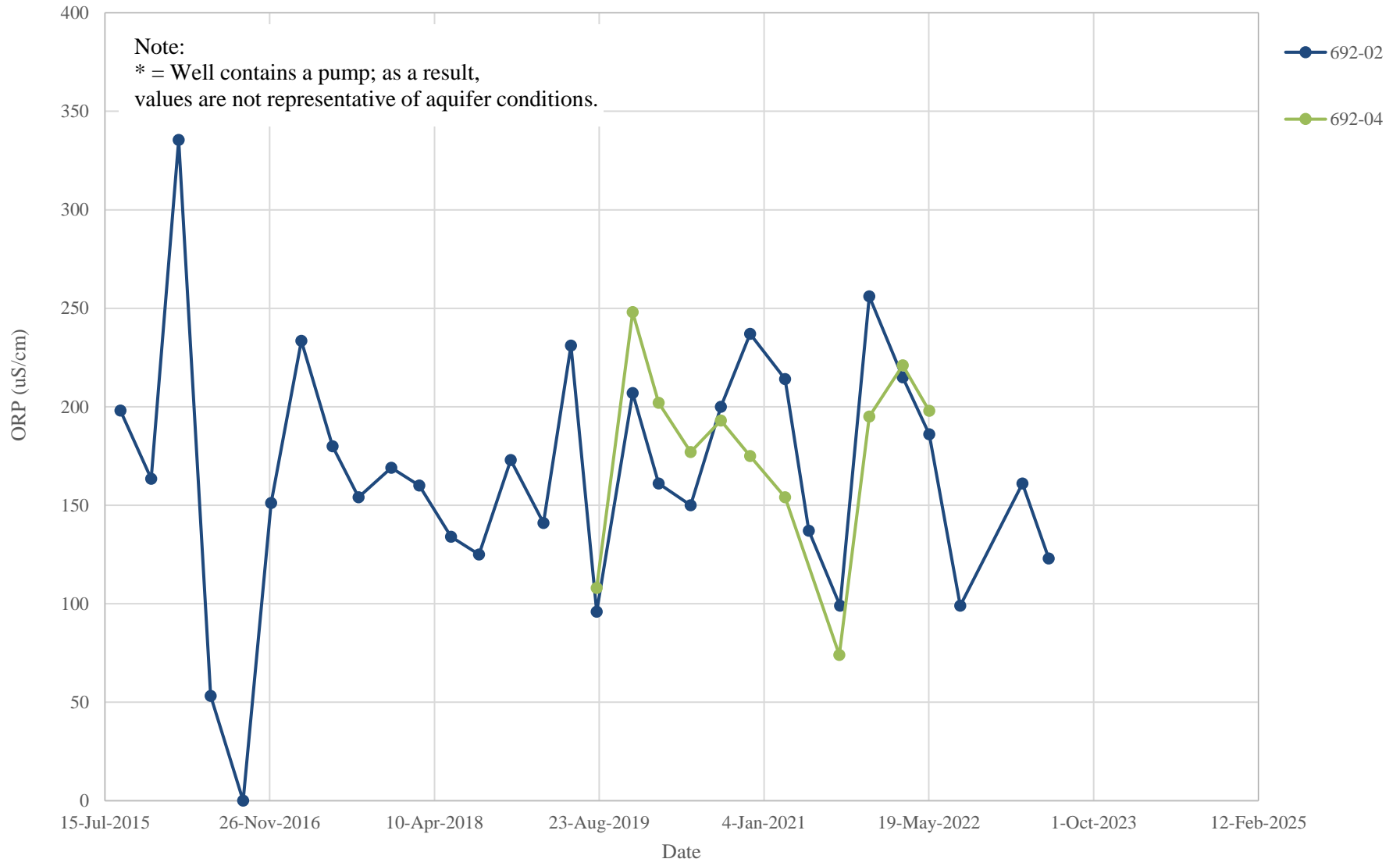

APPENDIX F

**CONCENTRATION TRENDS BY AREA -
ABATEMENT PLAN WELLS**

**NITRATE CONCENTRATION TRENDS
 NORTHERN ABATEMENT PLAN MONITORING WELLS
 DONA ANA DAIRIES, DONA ANA COUNTY, NEW MEXICO**

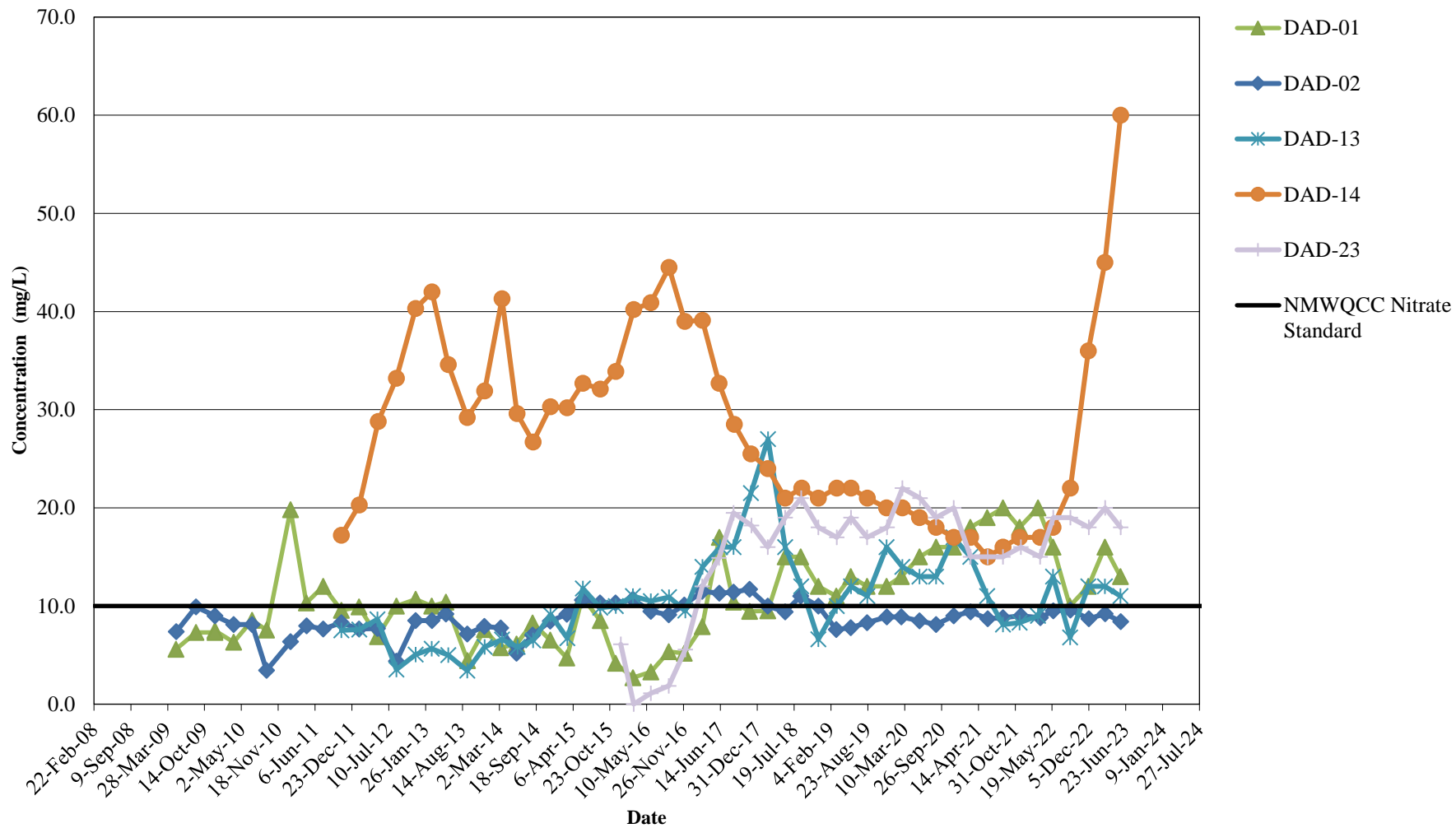

**NITRATE CONCENTRATION TRENDS
 NORTHERN ABATEMENT PLAN MONITORING WELLS -
 VERTICAL DELINEATION
 DONA ANA DAIRIES, DONA ANA COUNTY, NEW MEXICO**

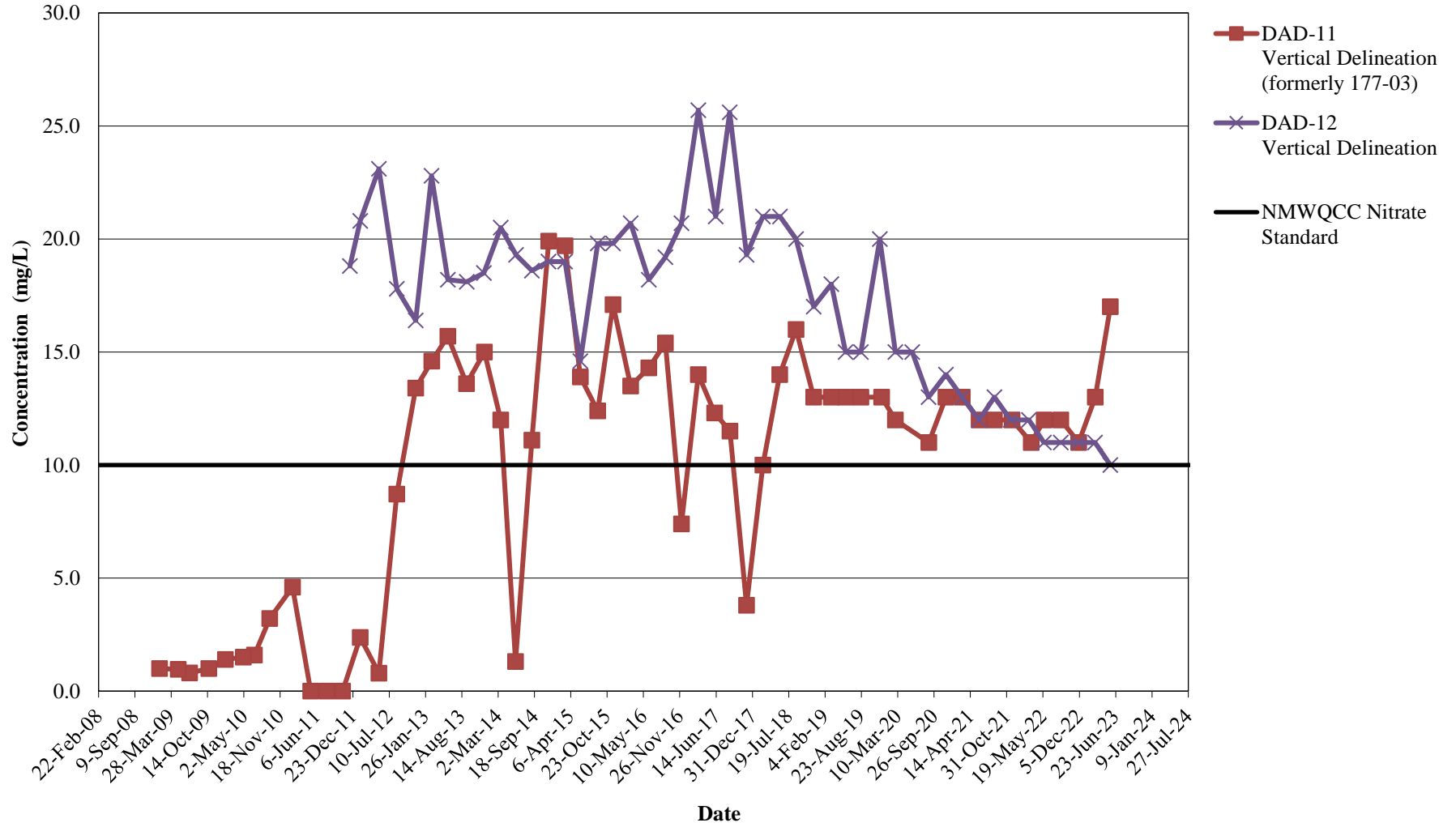

**NITRATE CONCENTRATION TRENDS
CENTRAL ABATEMENT PLAN MONITORING WELLS
DONA ANA DAIRIES, DONA ANA COUNTY, NEW MEXICO**

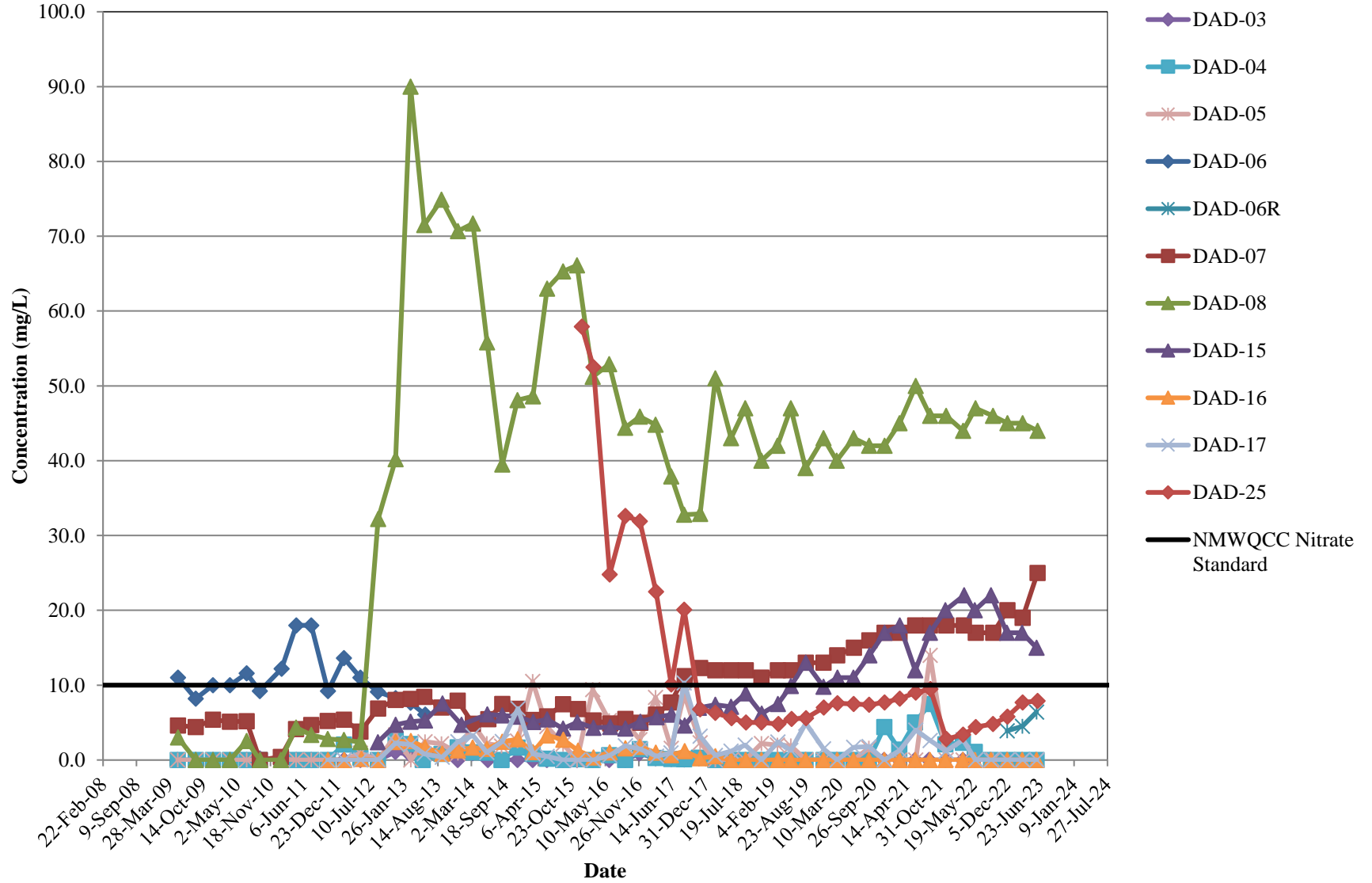

**NITRATE CONCENTRATION TRENDS
CENTRAL ABATEMENT PLAN MONITORING WELLS -
VERTICAL DELINEATION
DONA ANA DAIRIES, DONA ANA COUNTY, NEW MEXICO**

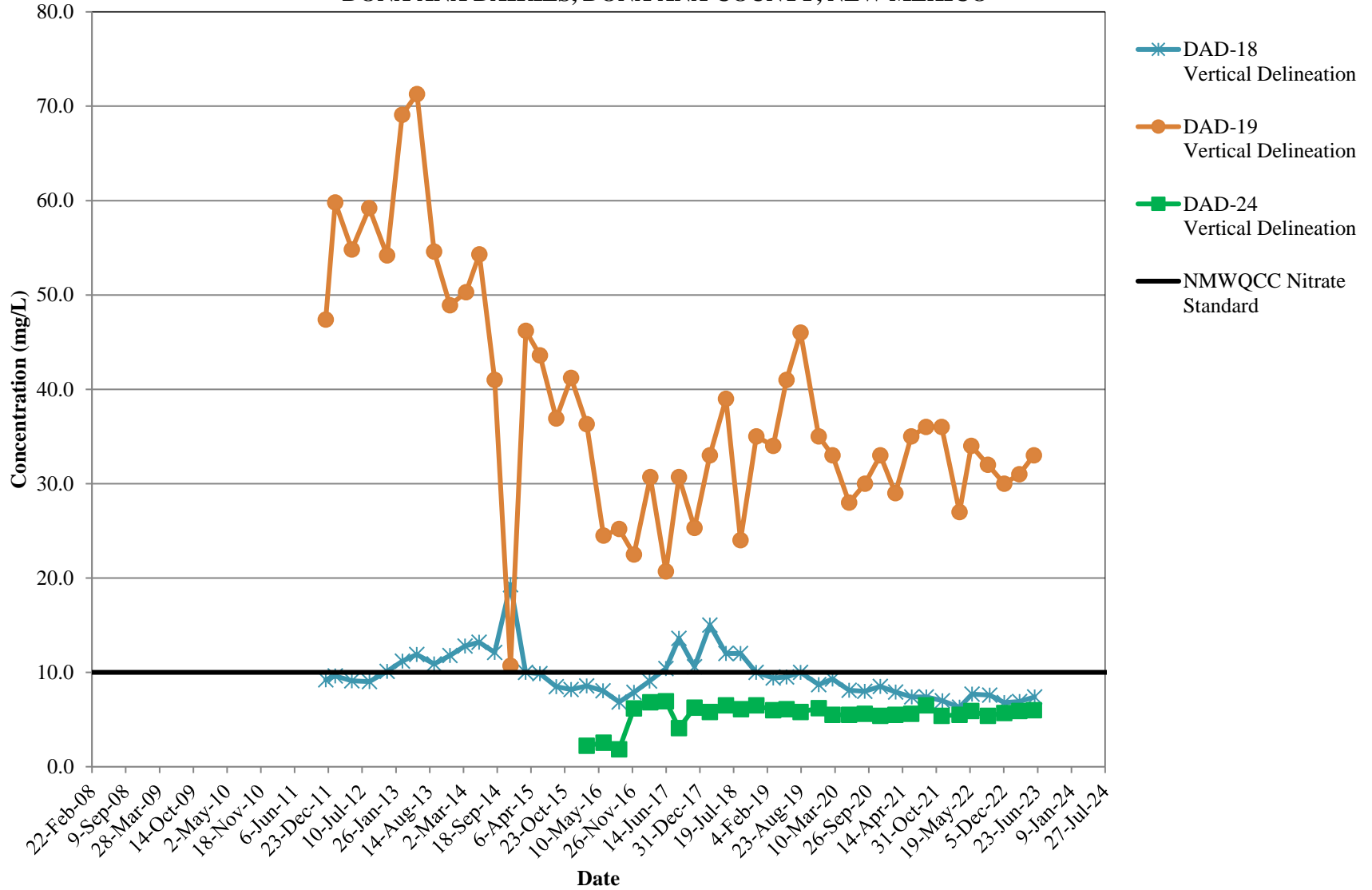

**NITRATE CONCENTRATION TRENDS
SOUTHERN ABATEMENT PLAN MONITORING WELLS
IN THE REGIONAL AQUIFER
DONA ANA DAIRIES, DONA ANA COUNTY, NEW MEXICO**

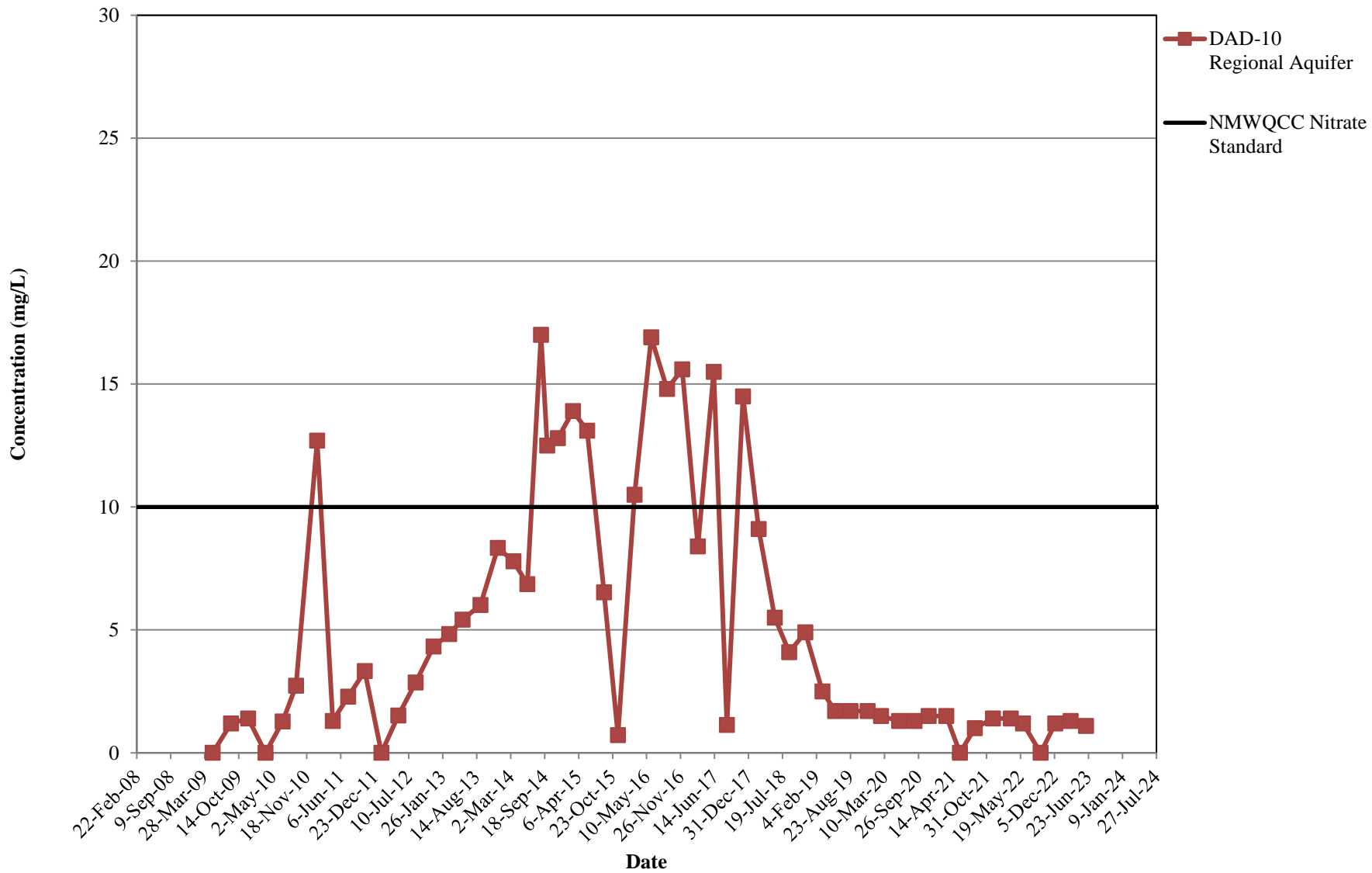

**NITRATE CONCENTRATION TRENDS
SOUTHERN ABATEMENT PLAN MONITORING WELLS
IN THE PERCHED AQUIFER
DONA ANA DAIRIES, DONA ANA COUNTY, NEW MEXICO**

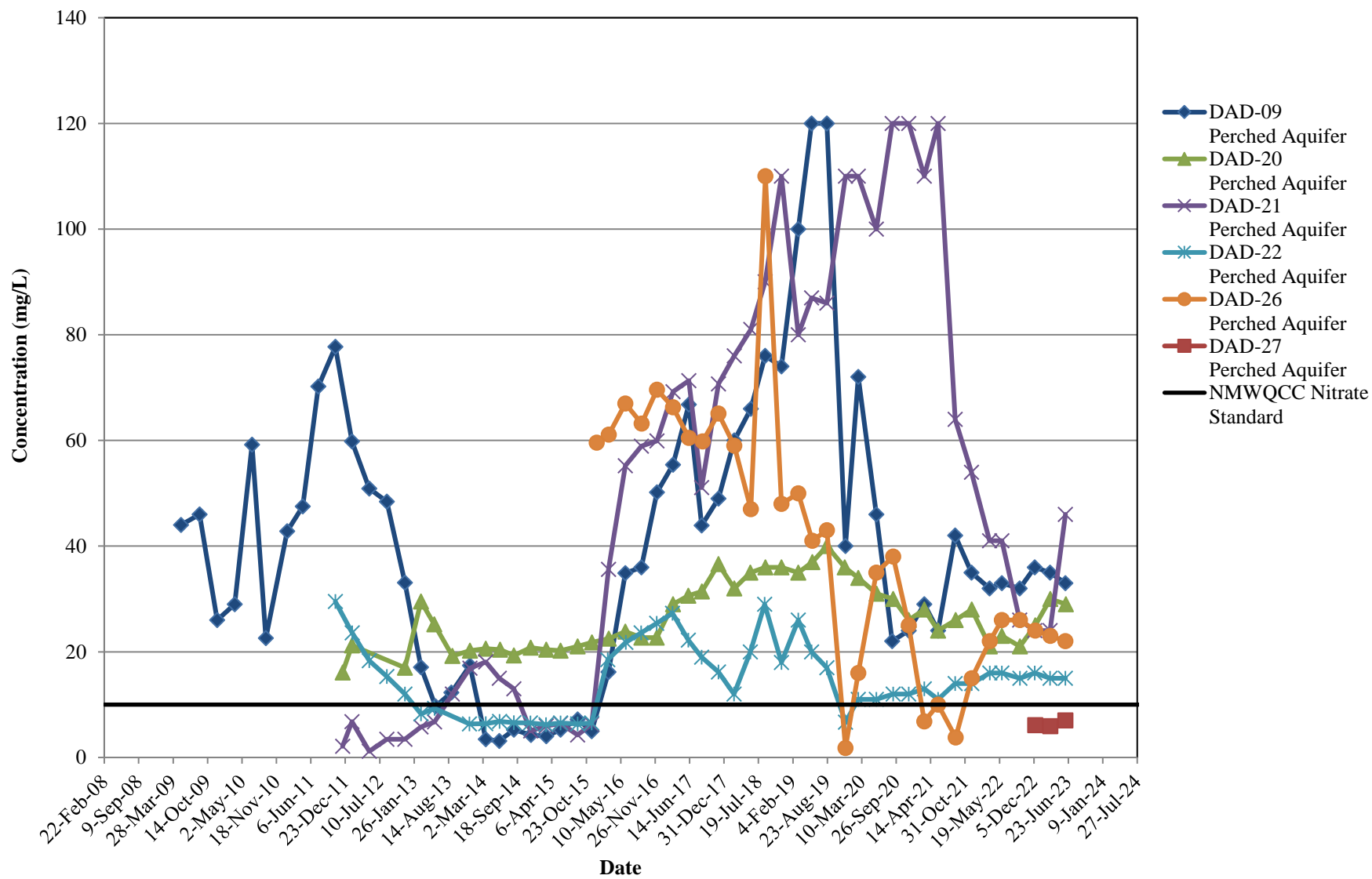

**CHLORIDE CONCENTRATION TRENDS
NORTHERN ABATEMENT PLAN MONITORING WELLS
DONA ANA DAIRIES, DONA ANA COUNTY, NEW MEXICO**

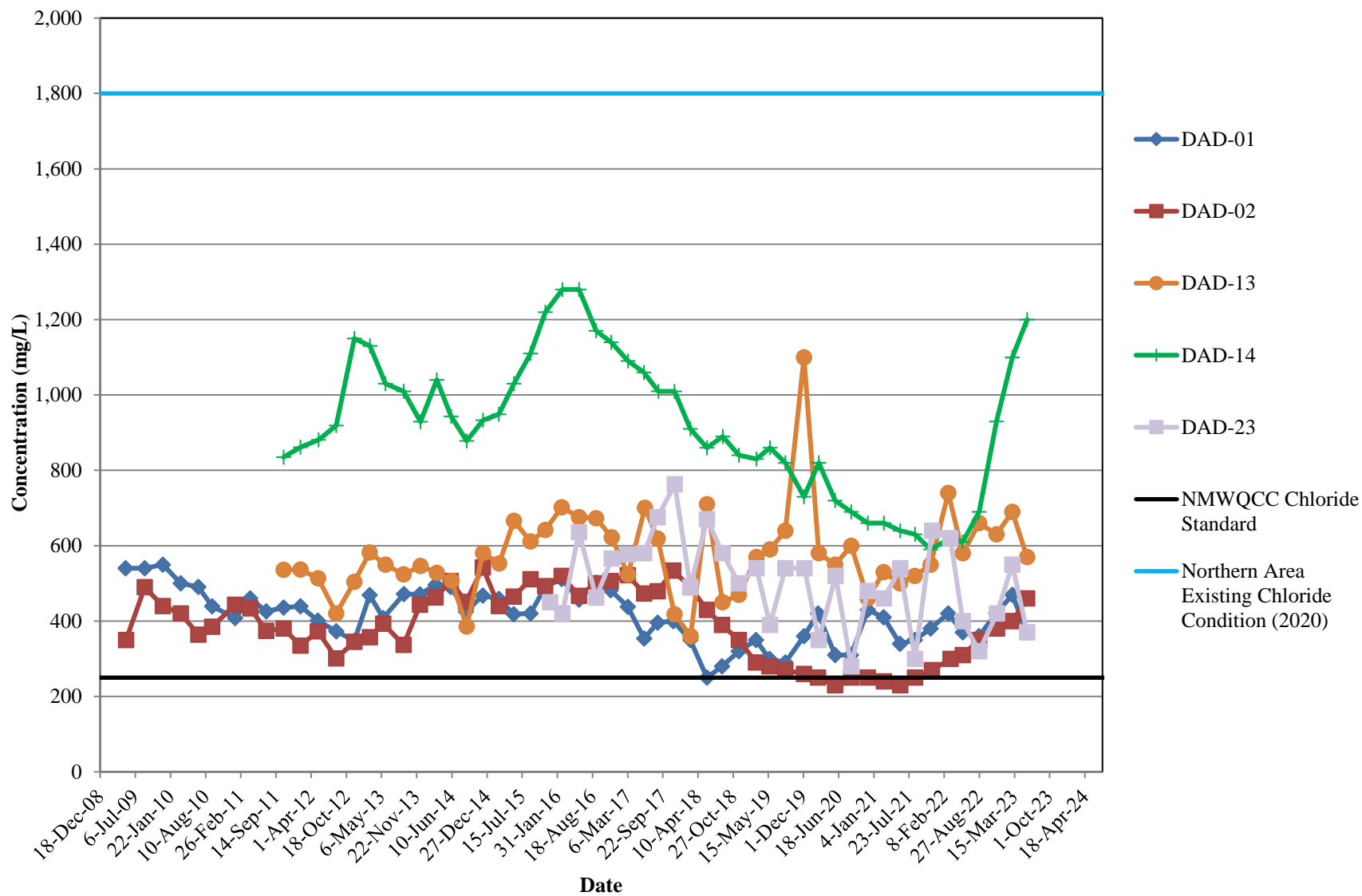

**CHLORIDE CONCENTRATION TRENDS
 NORTHERN ABATEMENT PLAN MONITORING WELLS -
 VERTICAL DELINEATION
 DONA ANA DAIRIES, DONA ANA COUNTY, NEW MEXICO**

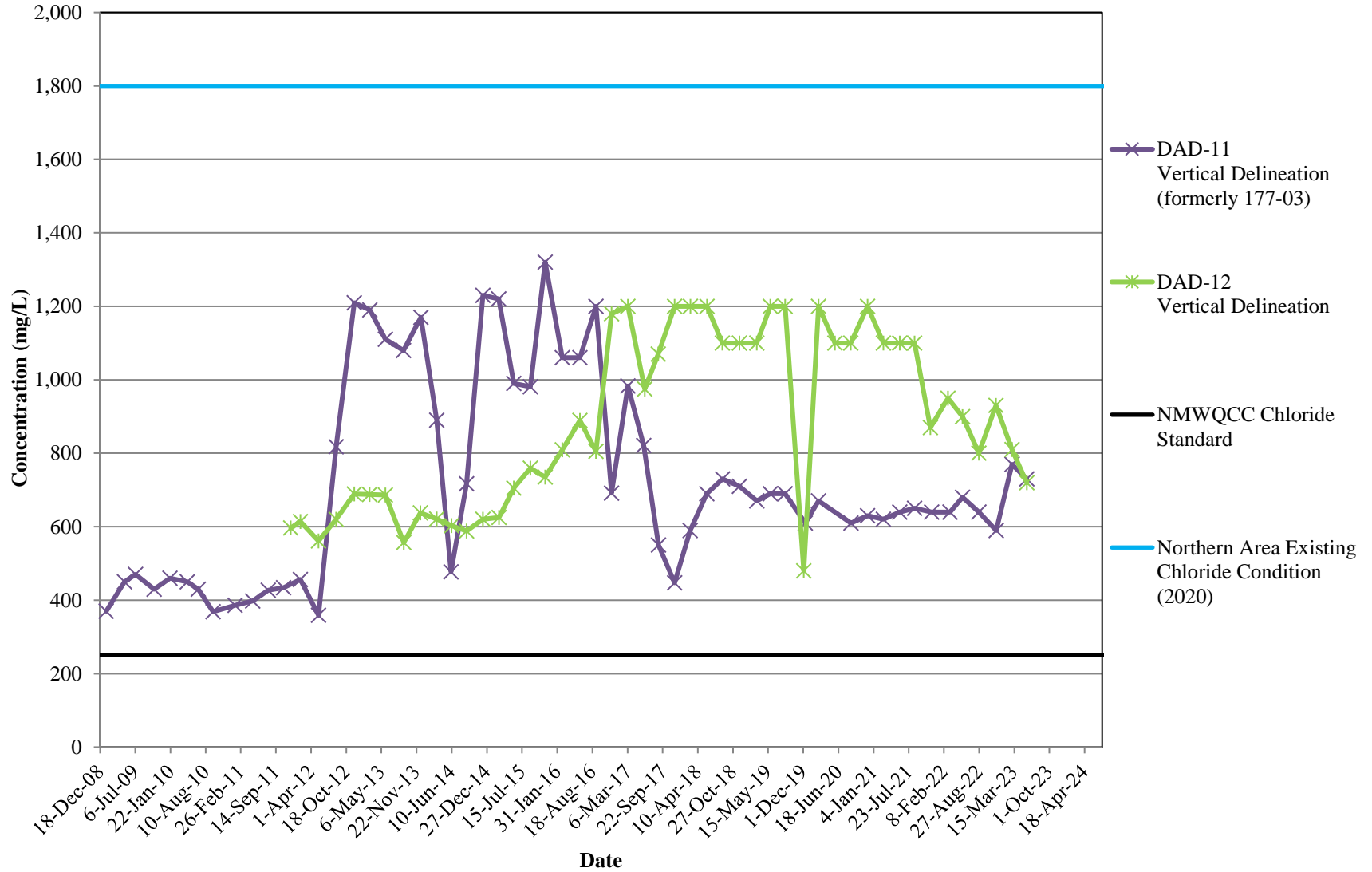

**CHLORIDE CONCENTRATION TRENDS
CENTRAL ABATEMENT PLAN MONITORING WELLS -
VERTICAL DELINEATION
DONA ANA DAIRIES, DONA ANA COUNTY, NEW MEXICO**

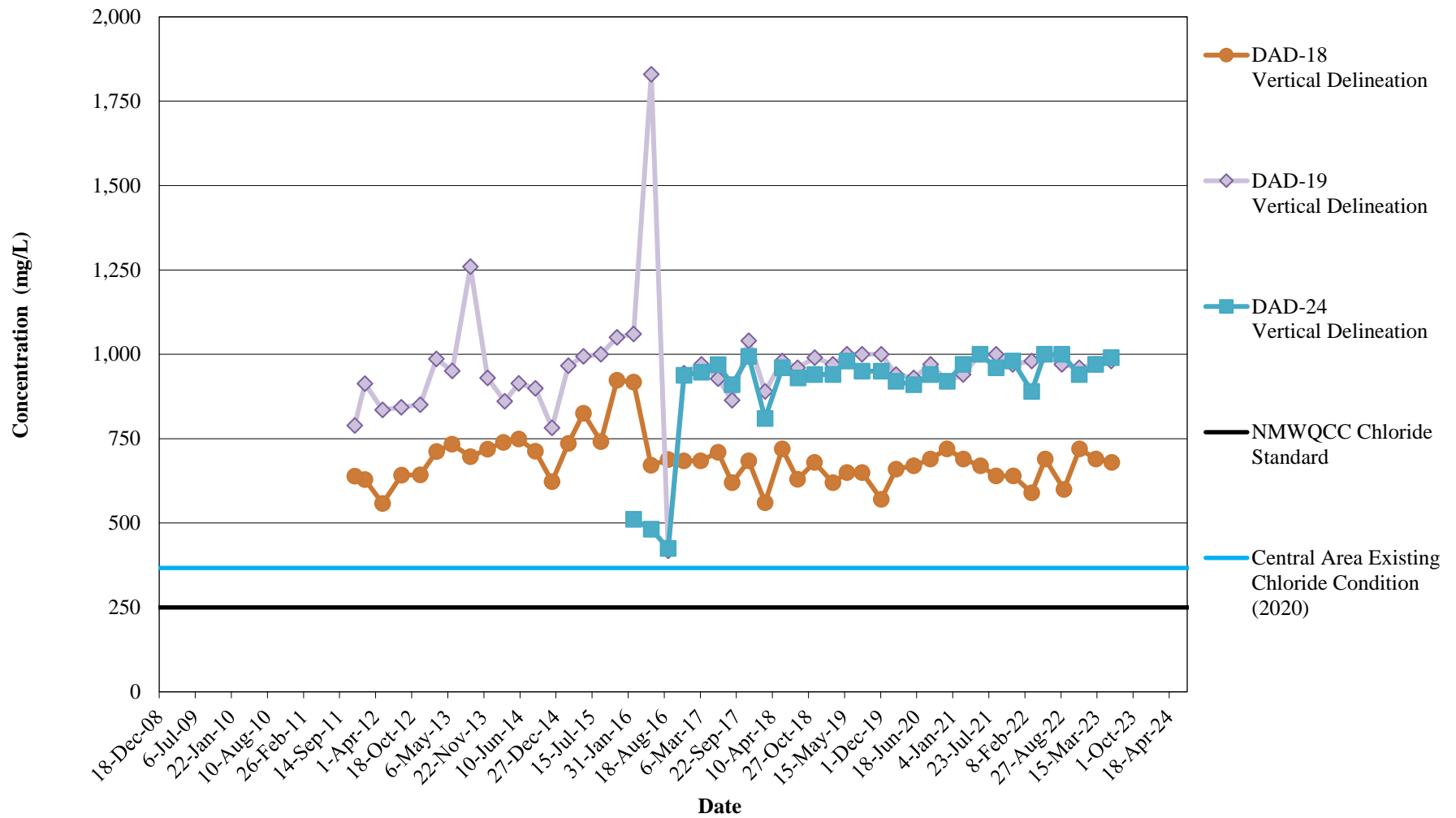

**CHLORIDE CONCENTRATION TRENDS
SOUTHERN ABATEMENT PLAN MONITORING WELLS
IN THE PERCHED AQUIFER
DONA ANA DAIRIES, DONA ANA COUNTY, NEW MEXICO**

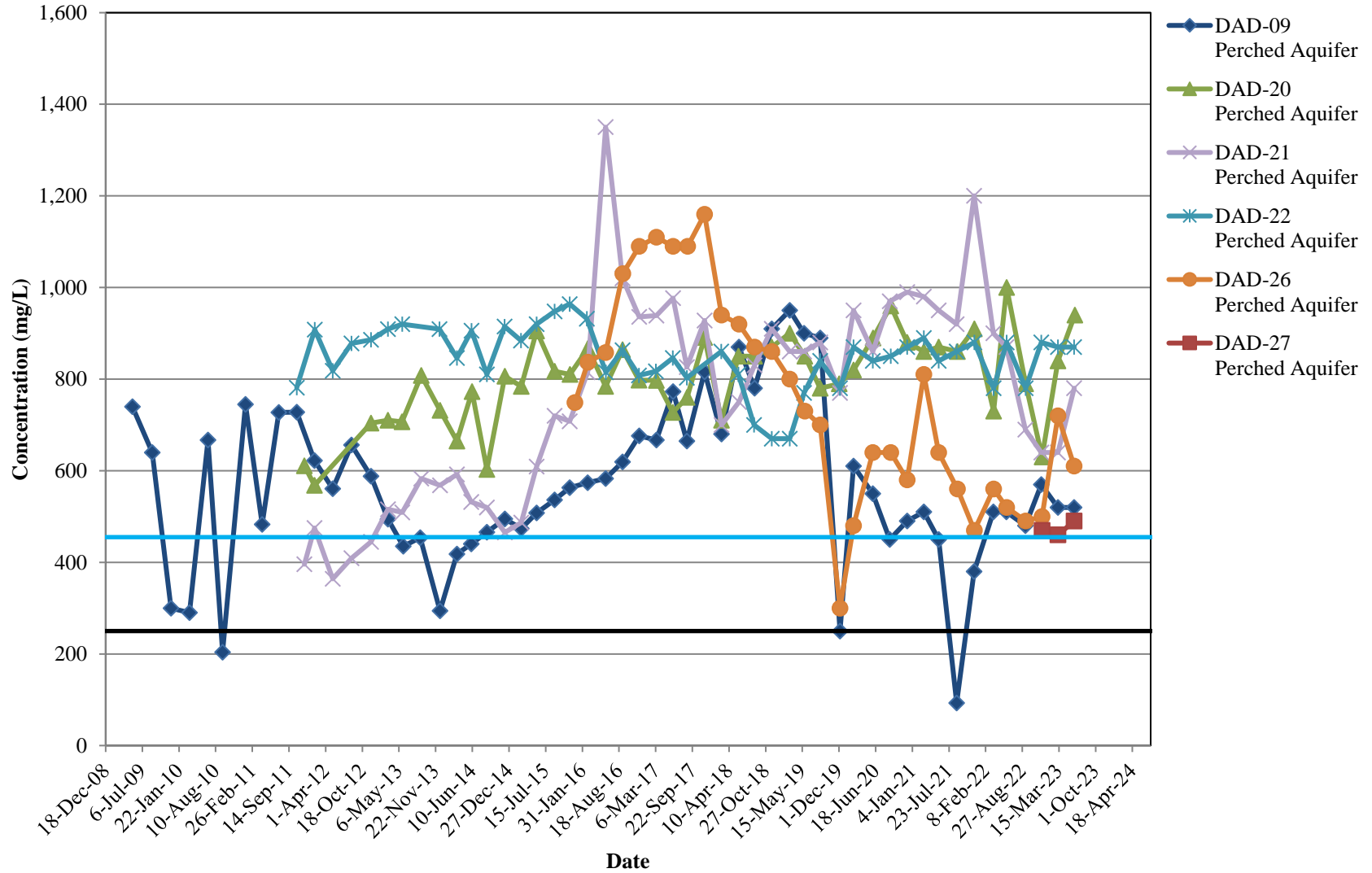

**CHLORIDE CONCENTRATION TRENDS
SOUTHERN ABATEMENT PLAN MONITORING WELLS
IN THE REGIONAL AQUIFER
DONA ANA DAIRIES, DONA ANA COUNTY, NEW MEXICO**

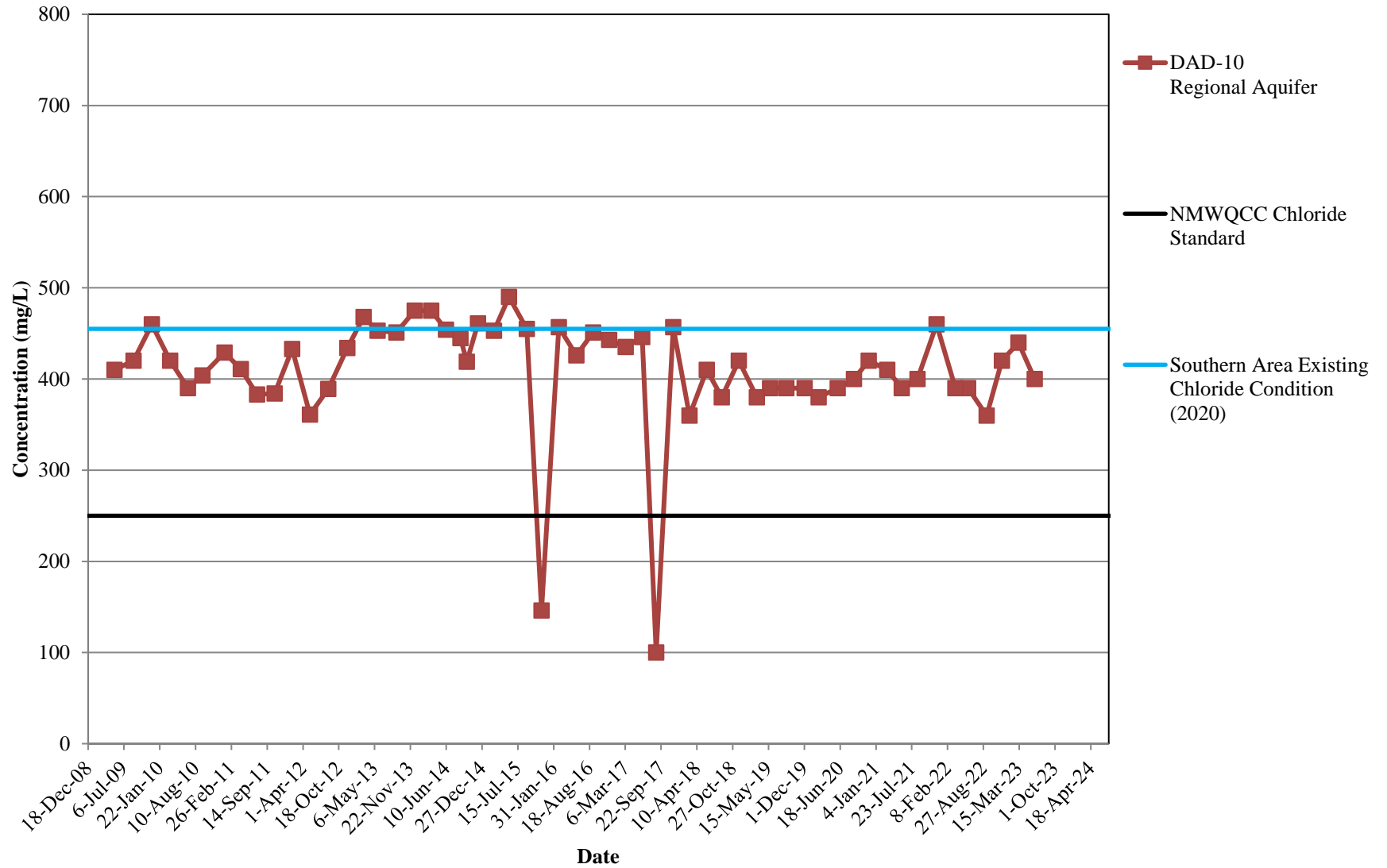

**TDS CONCENTRATION TRENDS
NORTHERN ABATEMENT PLAN MONITORING WELLS
DONA ANA DAIRIES, DONA ANA COUNTY, NEW MEXICO**

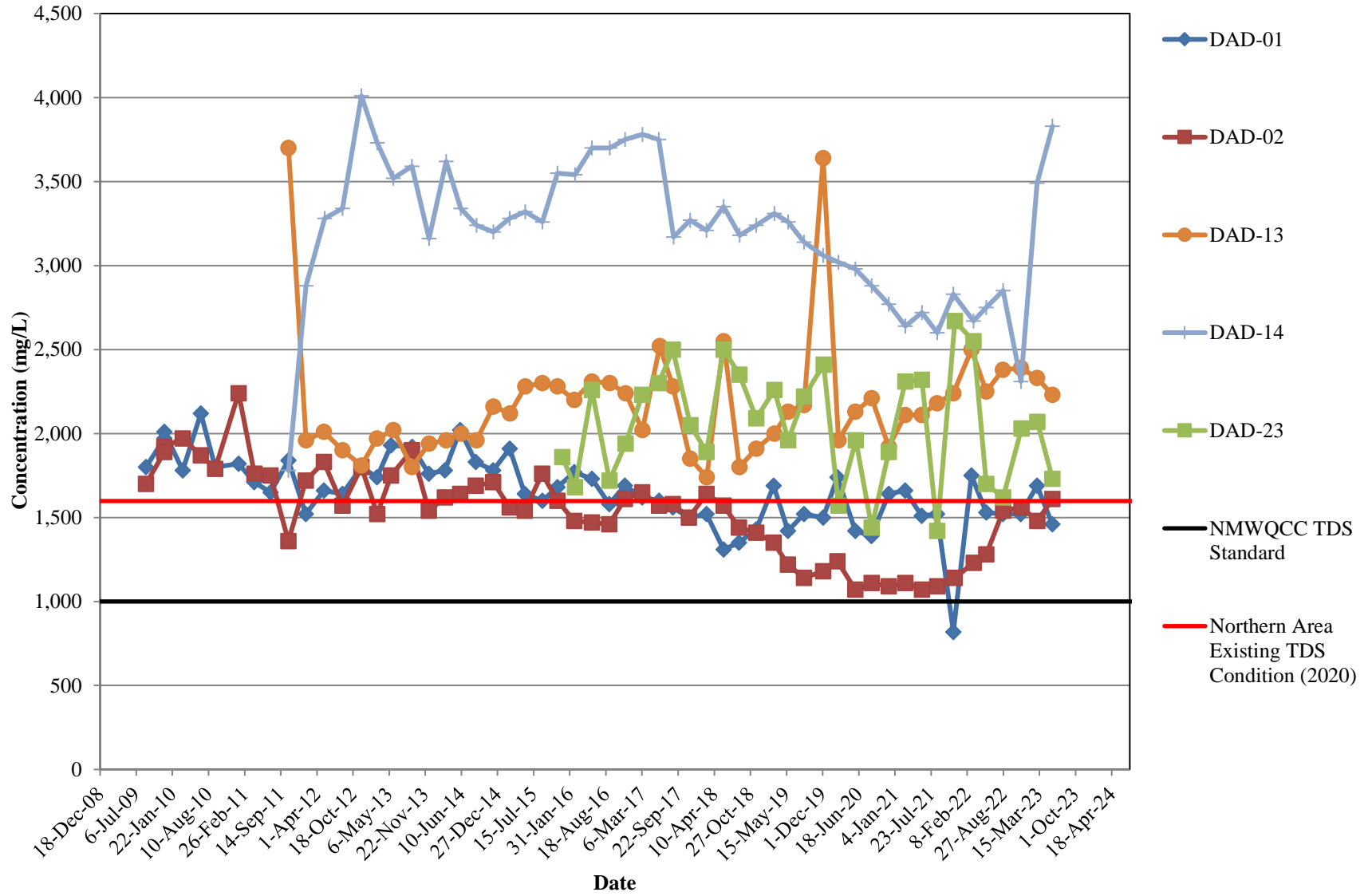

**TDS CONCENTRATION TRENDS
 NORTHERN ABATEMENT PLAN MONITORING WELLS -
 VERTICAL DELINEATION
 DONA ANA DAIRIES, DONA ANA COUNTY, NEW MEXICO**

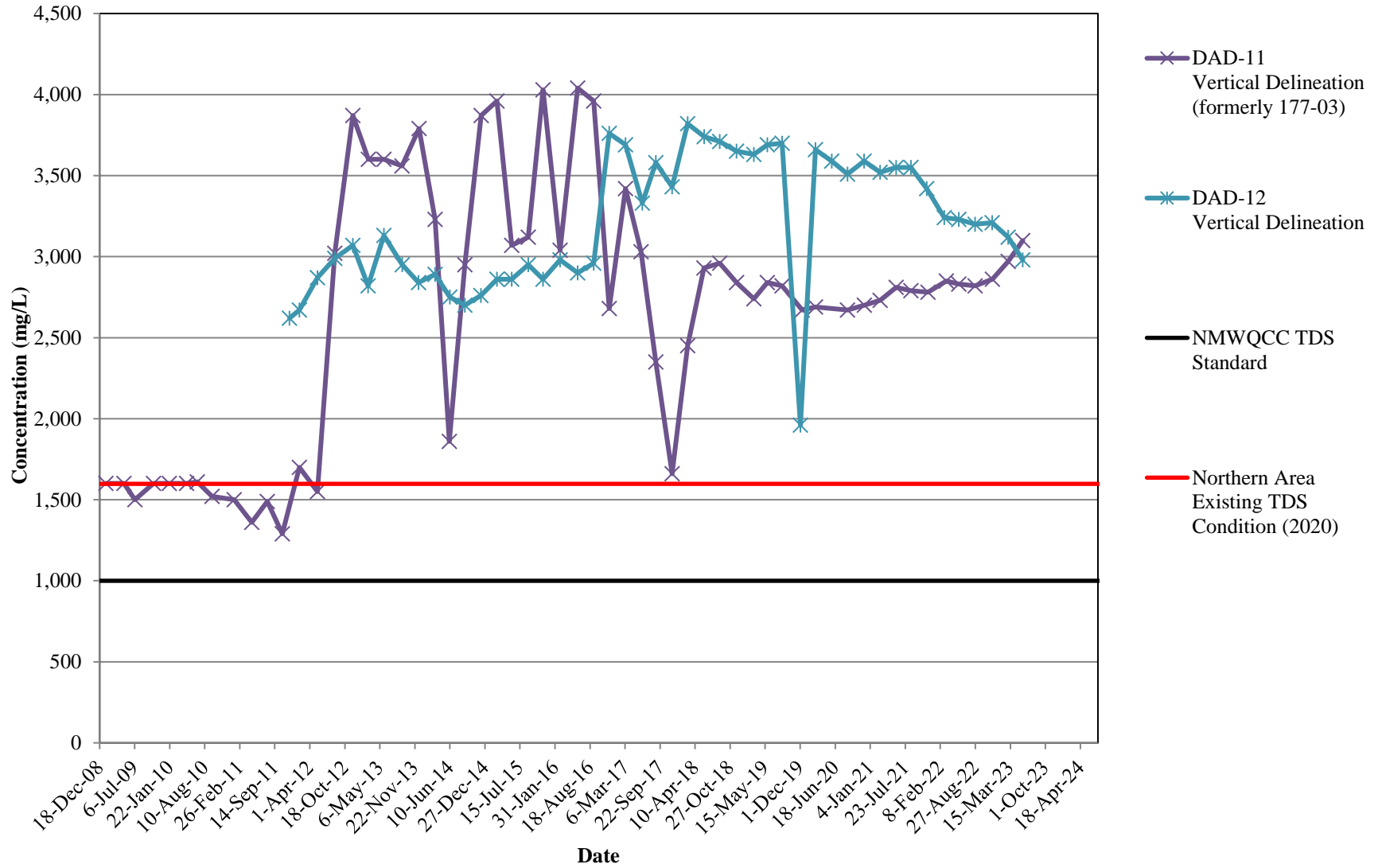

**TDS CONCENTRATION TRENDS
CENTRAL ABATEMENT PLAN MONITORING WELLS
DONA ANA DAIRIES, DONA ANA COUNTY, NEW MEXICO**

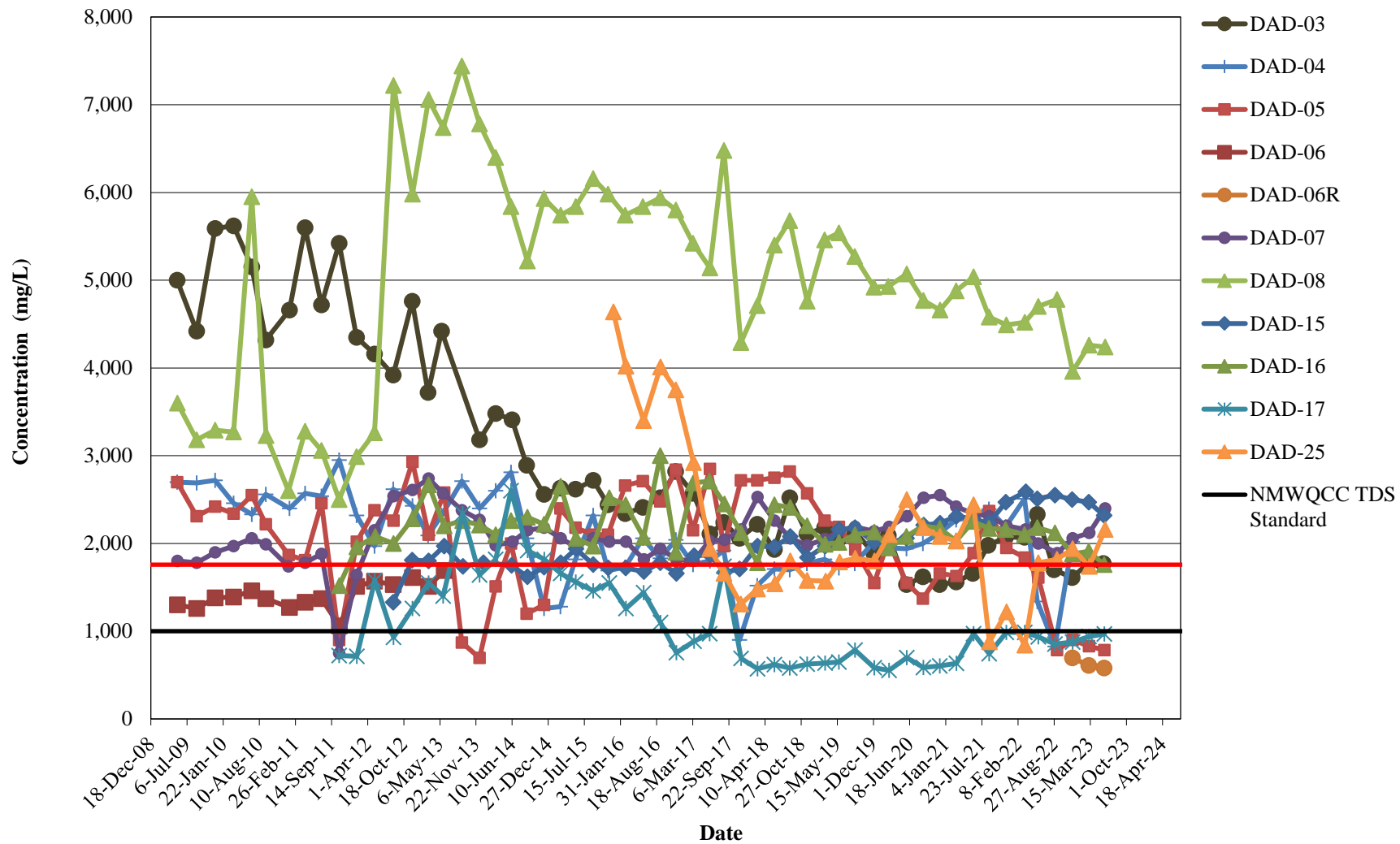

**TDS CONCENTRATION TRENDS
CENTRAL ABATEMENT PLAN MONITORING WELLS -
VERTICAL DELINEATION
DONA ANA DAIRIES, DONA ANA COUNTY, NEW MEXICO**

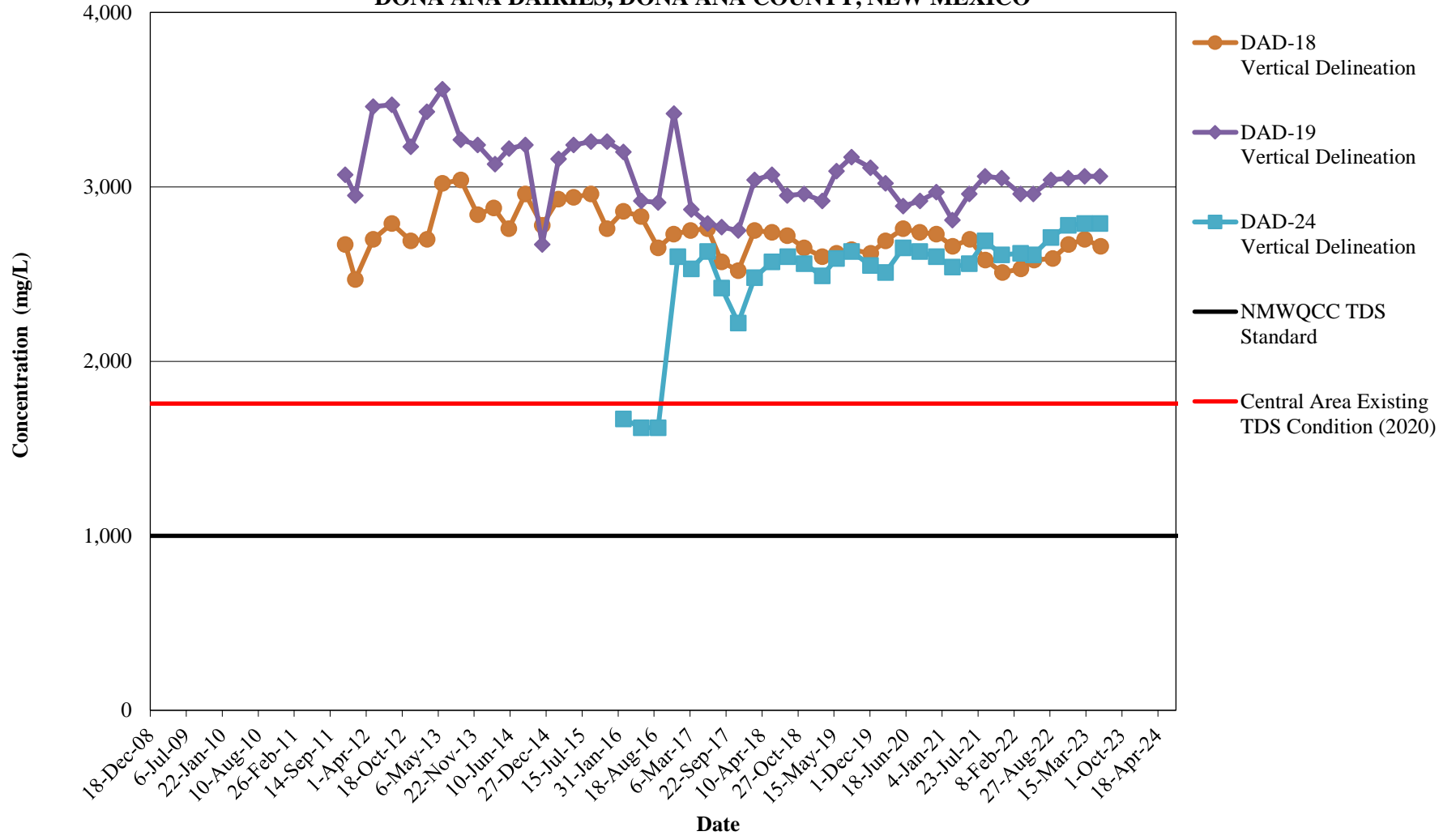

**TDS CONCENTRATION TRENDS
SOUTHERN ABATEMENT PLAN MONITORING WELLS
IN THE PERCHED AQUIFER
DONA ANA DAIRIES, DONA ANA COUNTY, NEW MEXICO**

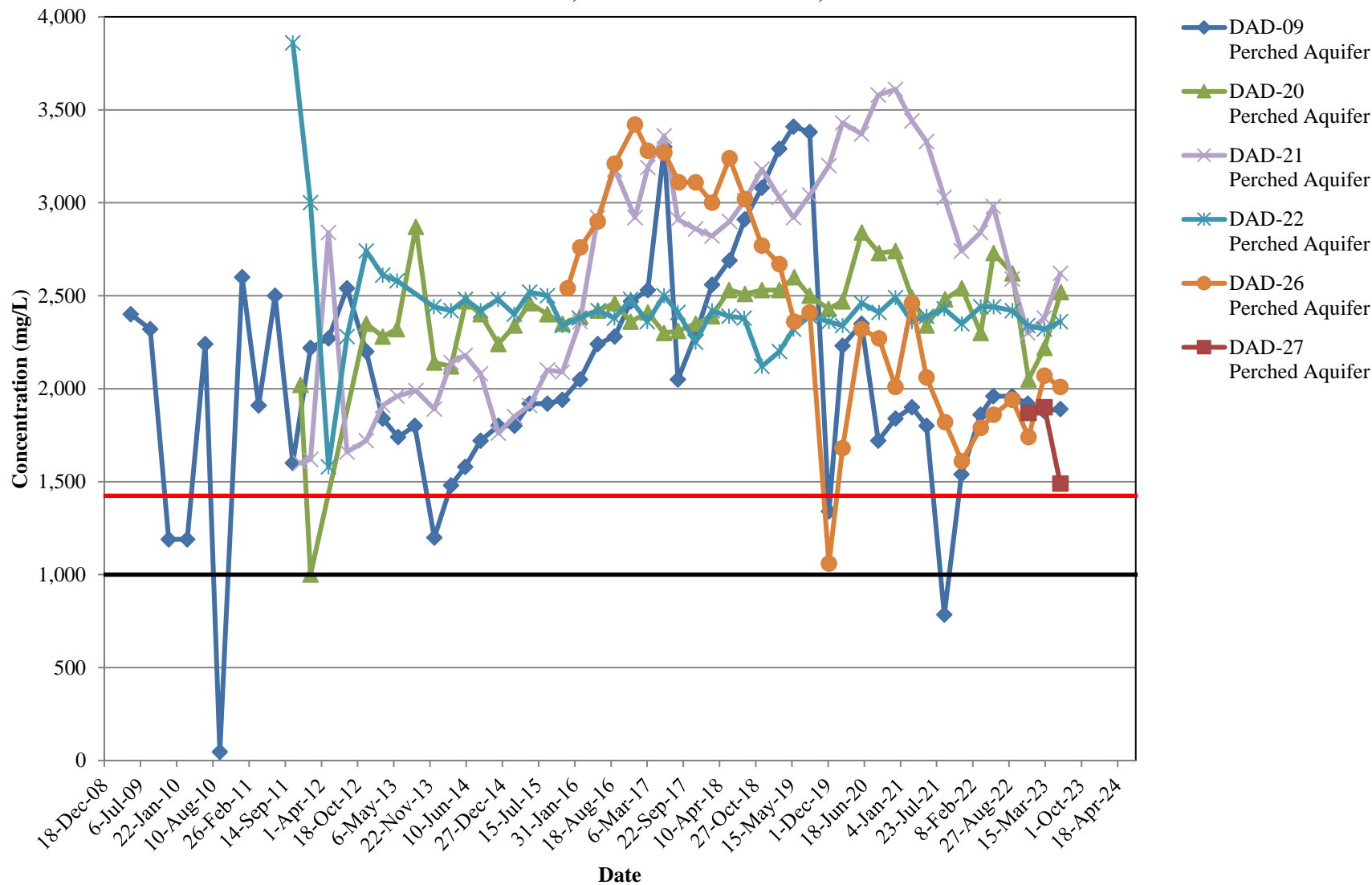

**TDS CONCENTRATION TRENDS
SOUTHERN ABATEMENT PLAN MONITORING WELLS
IN THE REGIONAL AQUIFER
DONA ANA DAIRIES, DONA ANA COUNTY, NEW MEXICO**

