

ATTACHMENT N

FIGURES

List of Figures for Permit

- Figure 1: LANL Regional Location Map
- Figure 2: LANL Facility Boundary and Technical Area (TA)-Specific Map
- Figure 3: LANL Facility Boundary with Detail of Non-LANL Areas
- Figure 4: TA-3 Security Fences, Entry Gates, and Entry Stations
- Figure 5: Reserved
- Figure 6: TA-50 Security Fences, Entry Gates, and Entry Stations
- Figure 7: TA-54, Area L, Security Fences, Entry Gates, and Entry Stations
- Figure 8: TA-54, Area G, Security Fences, Entry Gates, and Entry Stations
- Figure 9: TA-54 West Security Fences, Entry Gates, and Entry Stations
- Figure 10: TA-55 Security Fences, Entry Gates, and Entry Stations
- Figure 11: TA-3 Location Map
- Figure 12: TA-3, Building 29, Location Map
- Figure 13: TA-3 Building 29, Container Storage Unit, Portion of Room 9010
- Figure 14: TA-3, Building 29, Room 9020
- Figure 15: TA-3, Building 29, Room 9030
- Figure 16: Reserved
- Figure 17: Reserved
- Figure 18: Reserved
- Figure 19: Reserved
- Figure 20: Reserved
- Figure 21: Reserved
- Figure 22: TA-50 Location Map
- Figure 23: TA-50 Building 69, Indoor & Outdoor Units
- Figure 24: TA-54 Location Map
- Figure 25: TA-54, Areas G, H, L, and TA-54 West Location Map
- Figure 26: TA-54, Area L, Container Storage Units
- Figure 27: TA-54, Area G, Container Storage Units
- Figure 28: TA-54 Area G, Pad 9 (TWISP Domes 229, 230, 231, & 232)
- Figure 29: TA-54, Area G, Pad 1 (Dome 226 & Bldg 54-412 (DVRS))
- Figure 30: TA-54, Area G, Pad 3 (Dome 48)
- Figure 31: TA-54, Area G, Pad 10
- Figure 32: TA-54, Area G, Pad 5 (Domes 49 and 224; and Storage Sheds 144, 145, 146, 177, 1027, 1028, 1029, and 1041)
- Figure 33: TA-54, Area G, Pad 6 (Domes 153 & 283)
- Figure 34: TA-54, Area G, Storage Shed 8
- Figure 35: TA-54, Area G, Building 33
- Figure 36: TA-54, Area G, Pad 11 (Dome 375)
- Figure 37: TA-54 West, Building 38 (High Bay and Low Bay) and Outdoor Pad
- Figure 38: TA-55 Location Map
- Figure 39: TA-55, Building 4, Location Map
- Figure 40: TA-55, Building 4, Room B40– UCNI
- Figure 41: TA-55, Building 4, Room K13– UCNI
- Figure 42: TA-55, Building 4, Room B05– UCNI
- Figure 43: TA-55, Building 4, Room B45 – UCNI
- Figure 44: TA-55, Building 4, Vault – UCNI

Figure 45: TA-55, Building 4, Outdoor Container Storage Pad
Figure 46: TA-55, Building 185
Figure 47: TA-55, Building 4, Room 401, Storage Tank System Process Flow Diagram
Figure 48: TA-55, Building 4, Room 401, Cementation Unit Process Flow Diagram
Figure 49: Emergency Facilities at Los Alamos National Laboratory
Figure 50: TA-54, MDA H
Figure 51: Reserved
Figure 52: Reserved
Figure 53: Reserved
Figure 54: TA-63 Location Map
Figure 55: TA-63 Transuranic Waste Facility
Figure 56: Transuranic Waste Facility Subsurface Vapor Monitoring Network

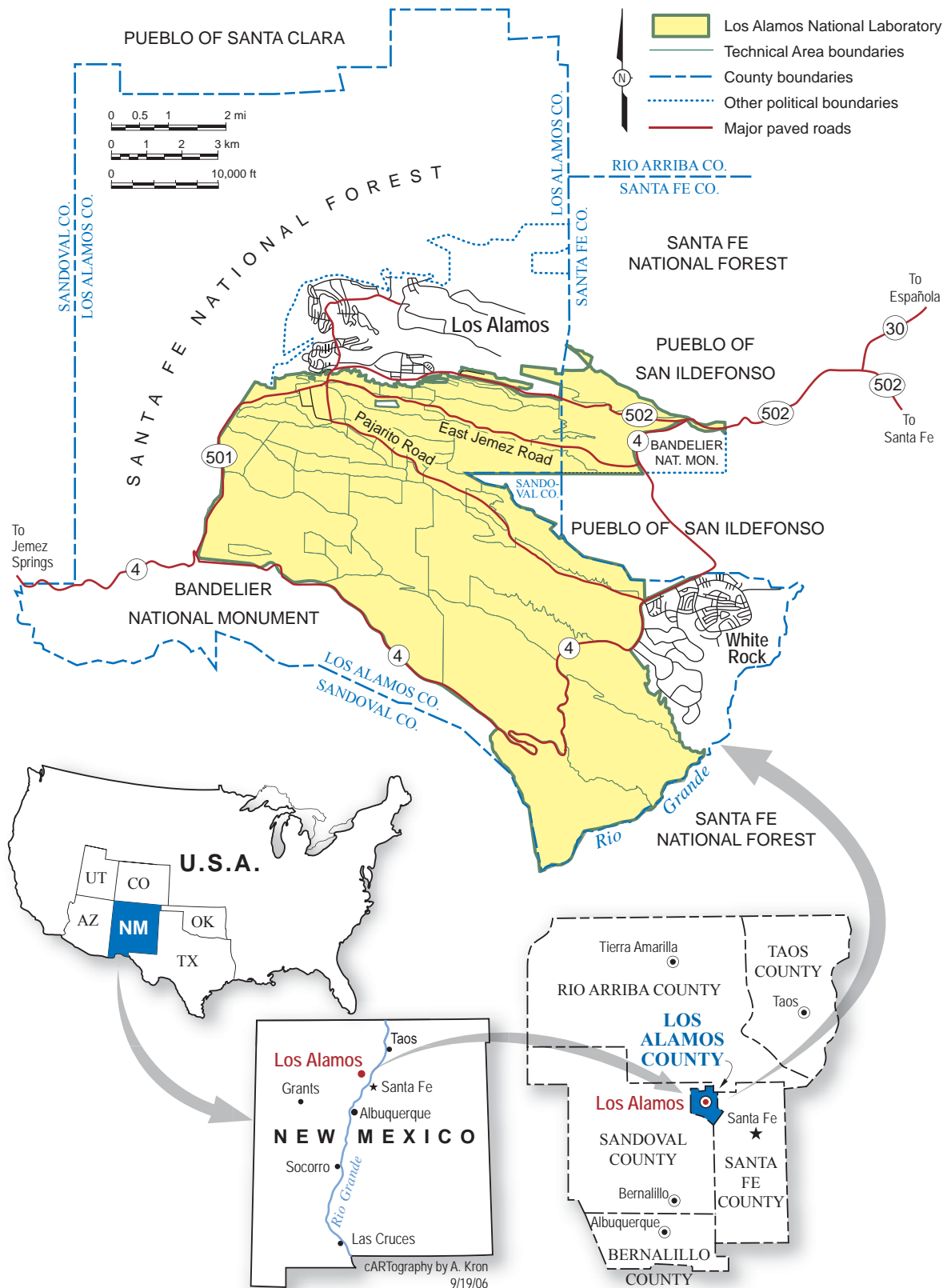
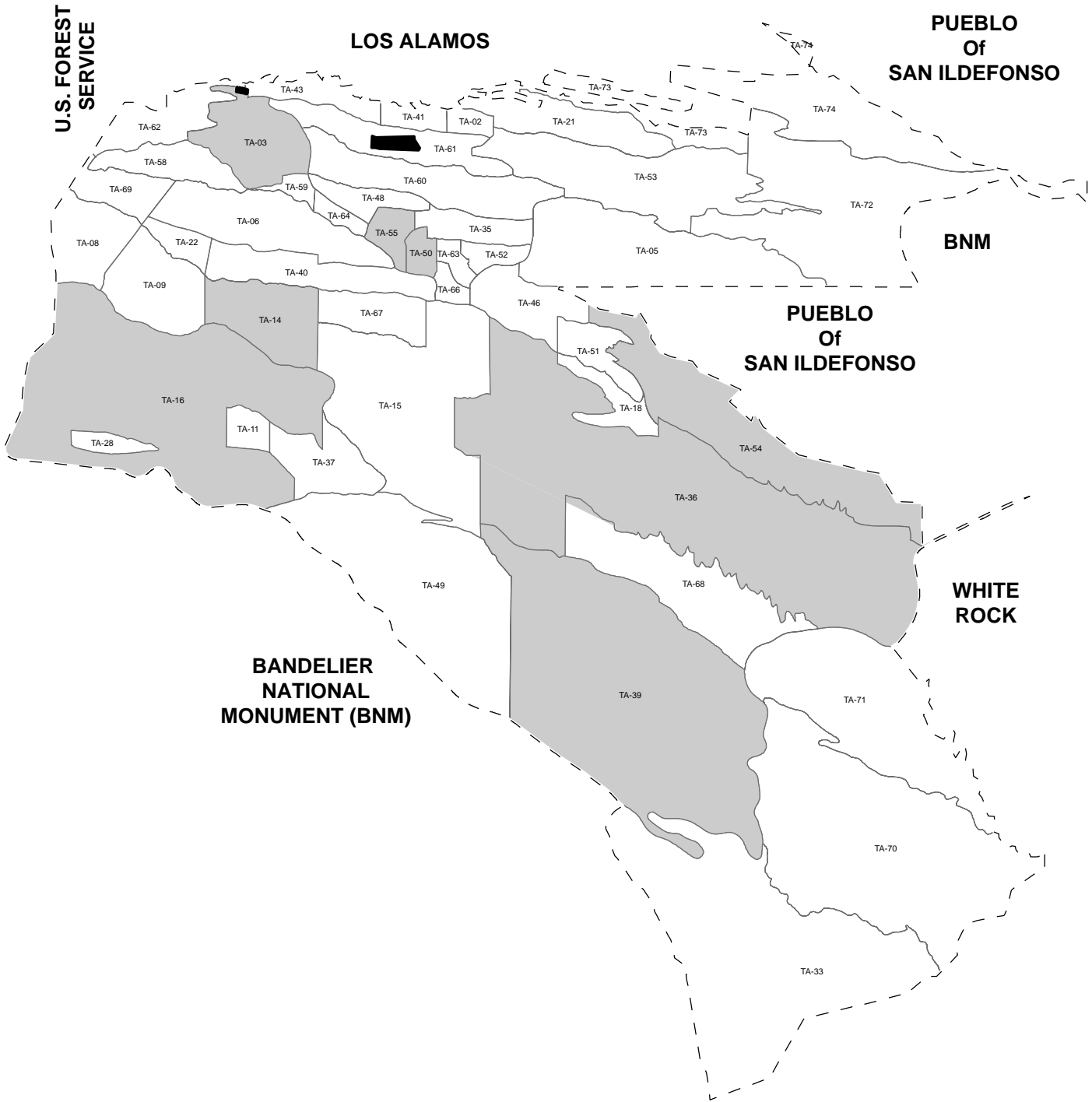

Figure 1
Regional Location Map of Los Alamos National Laboratory



Legend

 Not LANL Property

0 5,000 10,000
 Feet

Figure 2
 Facility Boundary and Location Map of Los Alamos National Laboratory (LANL)
 Technical Areas (TAs)

Created by ERSS GIS TEAM. Map Number 06-0108 September 12, 2005
 State Plane Coordinate System New Mexico Central Zone North American Datum 1983 (ft)
 This map was created for work processes associated with the Environmental & Remediation Support Services. All other uses for this map should be confirmed with LANL EP-ERSS staff.
 Boundary of Department of Energy Property I Around the Los Alamos National Laboratory; Los Alamos National Laboratory, SSMO Site Planning & Project Initiation; Infrastructure Planning Office. 10 February 2006
 Boundary of Department of Energy Property In and Around the Los Alamos National Laboratory; Los Alamos National Laboratory, SSMO Site Planning & Project Initiation; 01 February 2003 as captured 07 September 2004.

Two areas outlined in red and shown in overviews are not under LANL control

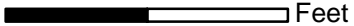
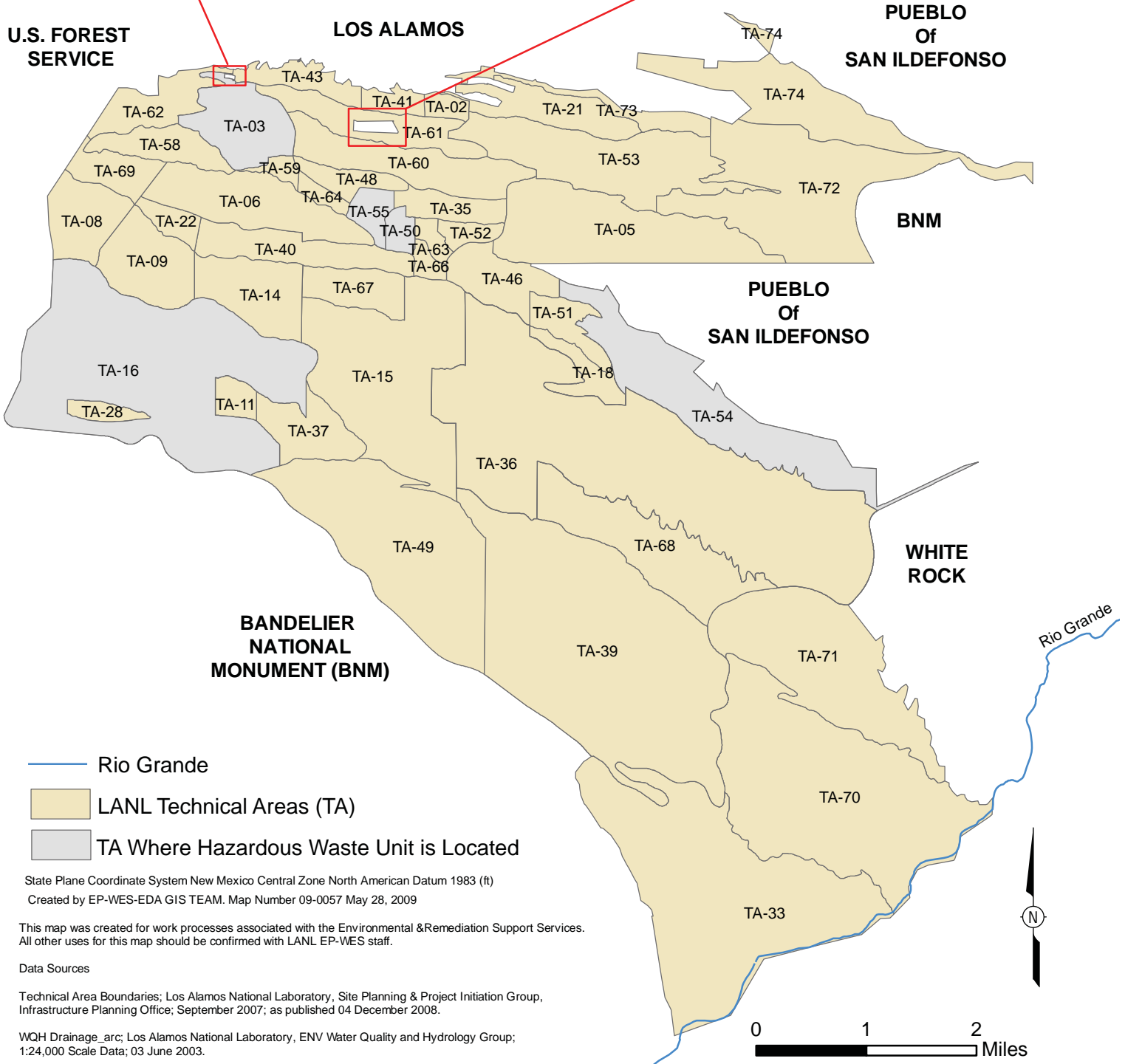
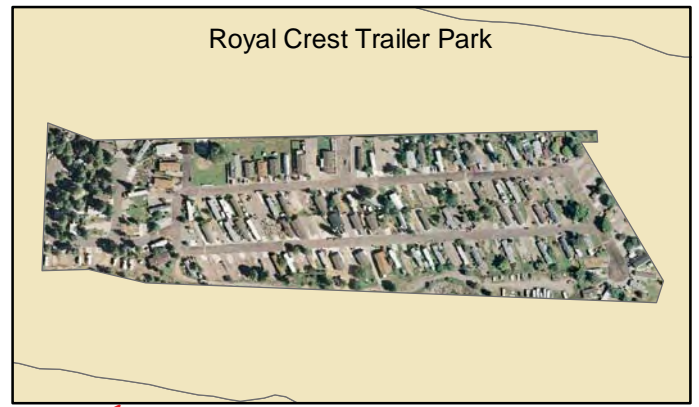

Figure 3: Los Alamos National Laboratory Facility Boundary with Detail of Non-LANL Areas

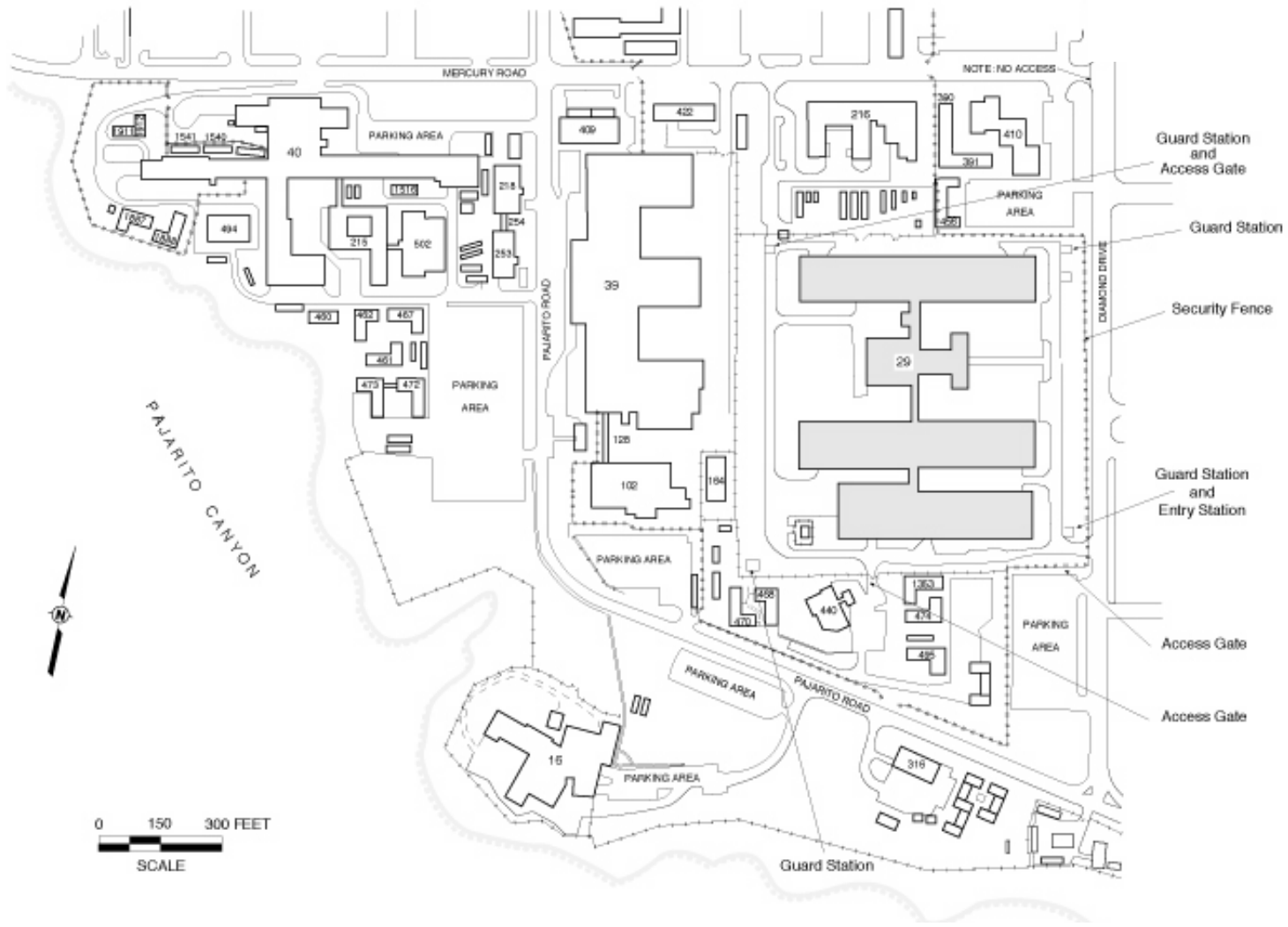

Figure 4
 Technical Area (TA) 3 Location Map Showing Security Fences, Entry Gates, and Entry Stations

FIGURE 5 – RESERVED

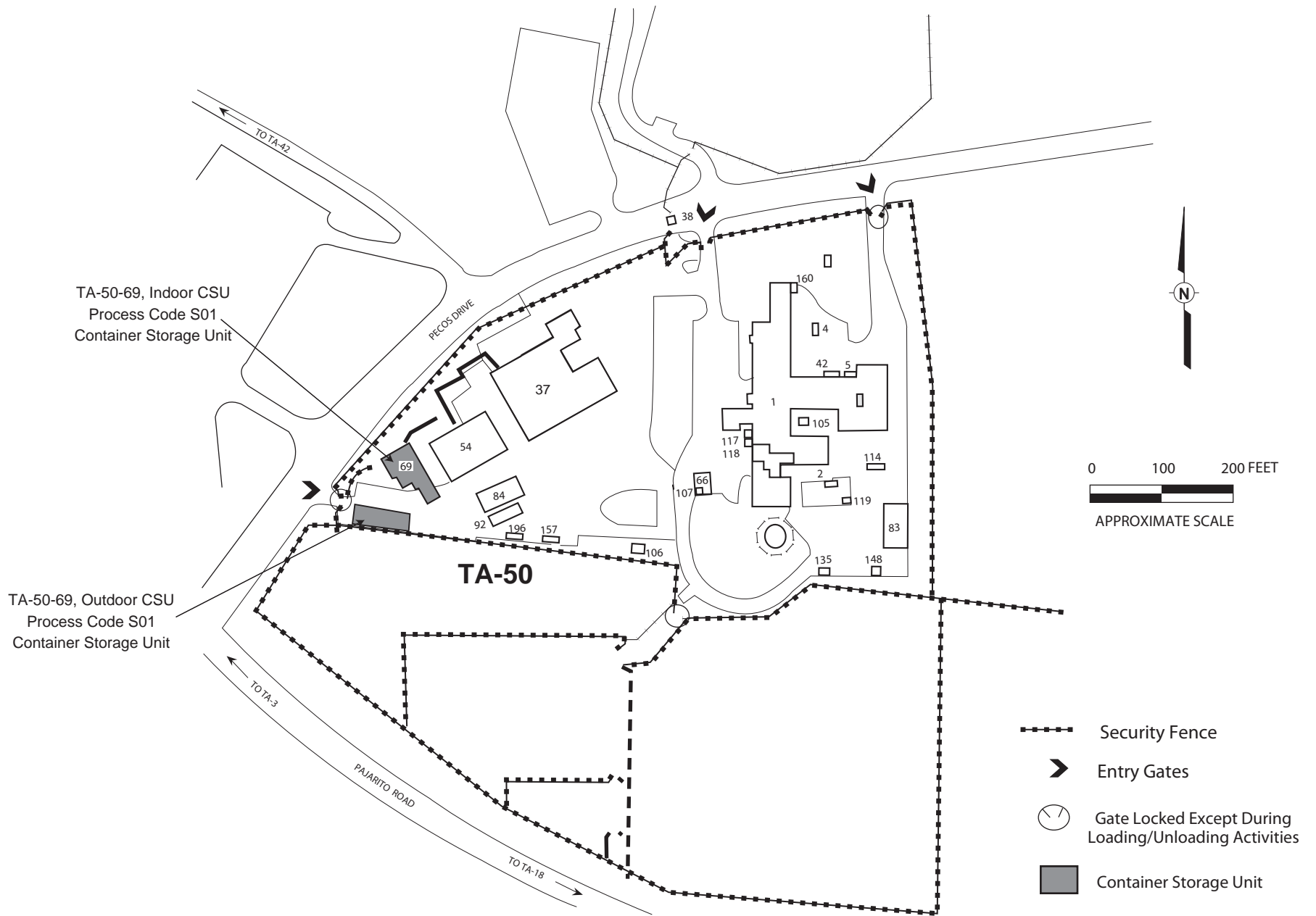

Figure 6:
Technical Area (TA) 50 Location Map Showing Security Fences, Entry Gates, and Entry Stations

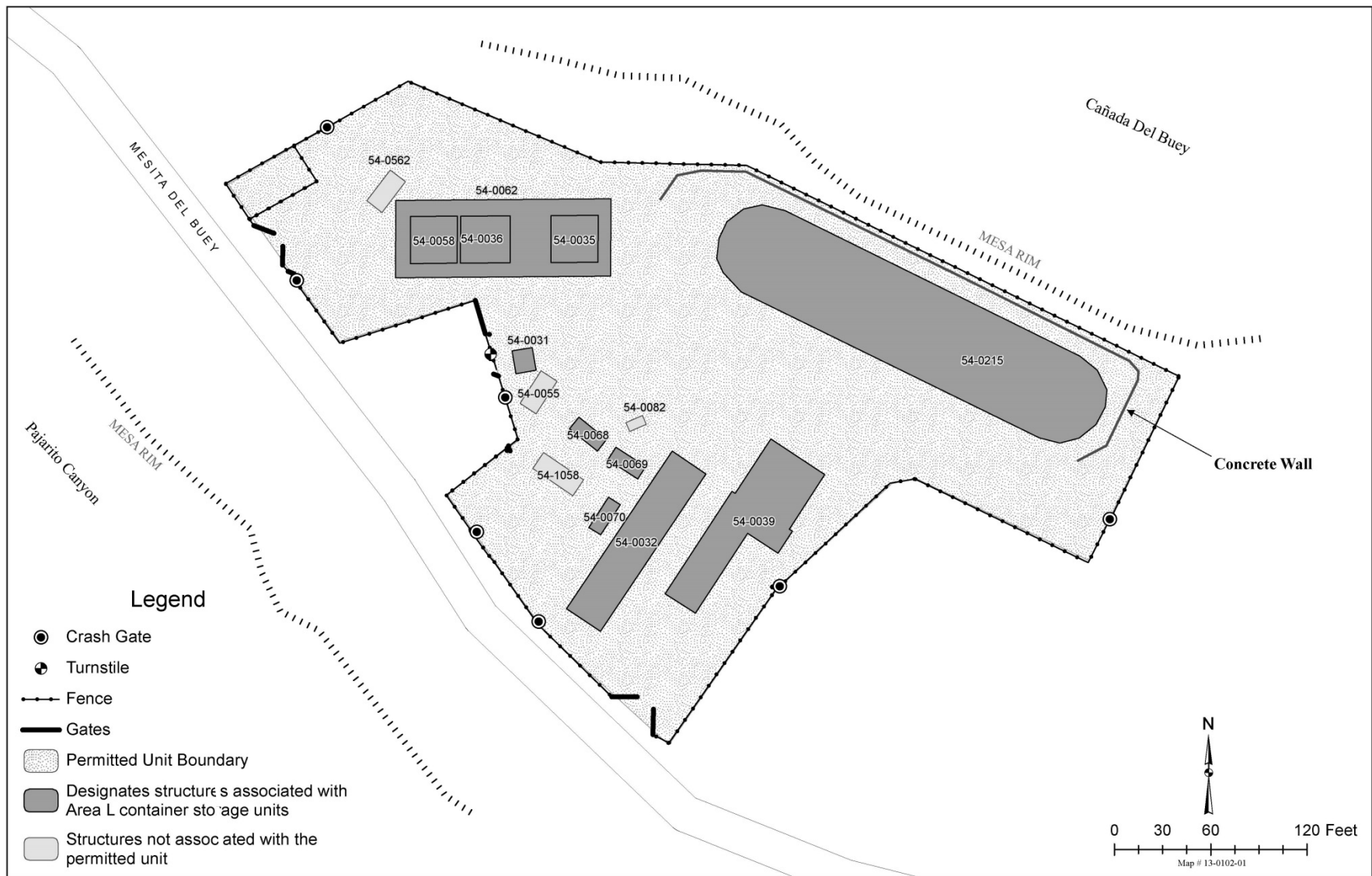
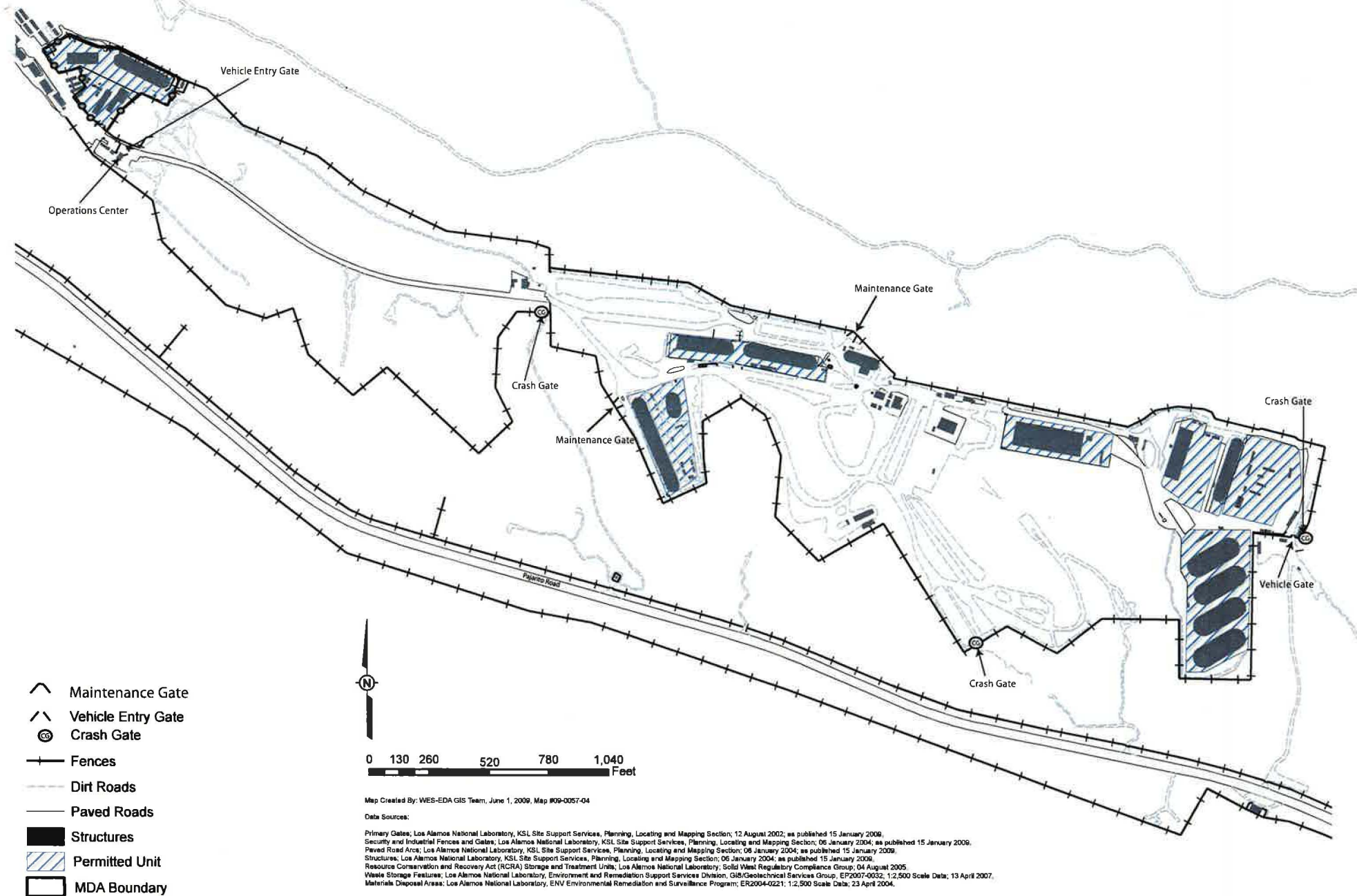

Figure 7: Technical Area 54, Area L, Security Fences, Entry Gates, and Entry Stations

Figure 8: Technical Area 54, Area G, Security Fences, Entry Gates, and Entry Stations



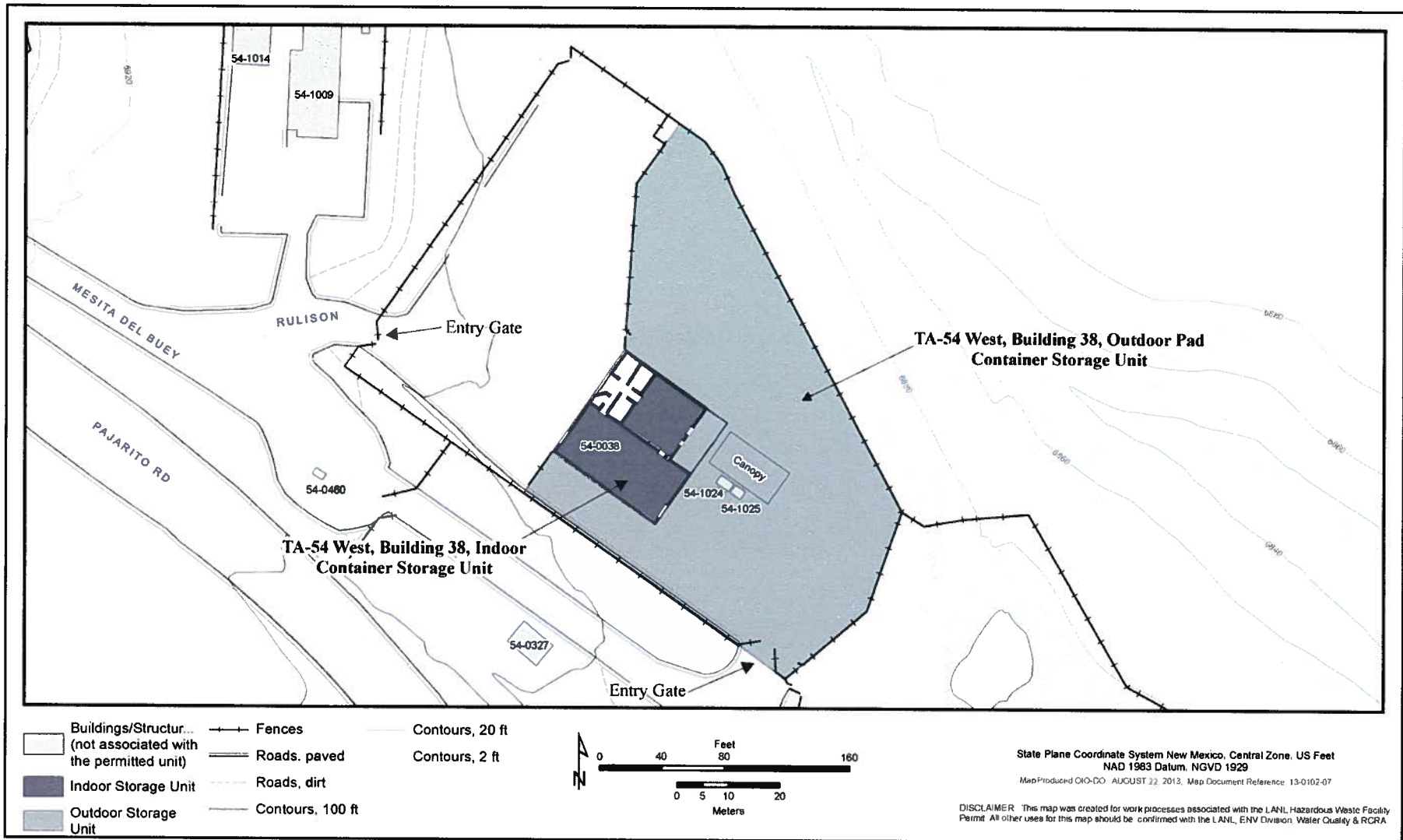

Figure 9: Technical Area (TA) 54 West Location Map Showing Security Fences, Entry Gates, and Entry Stations

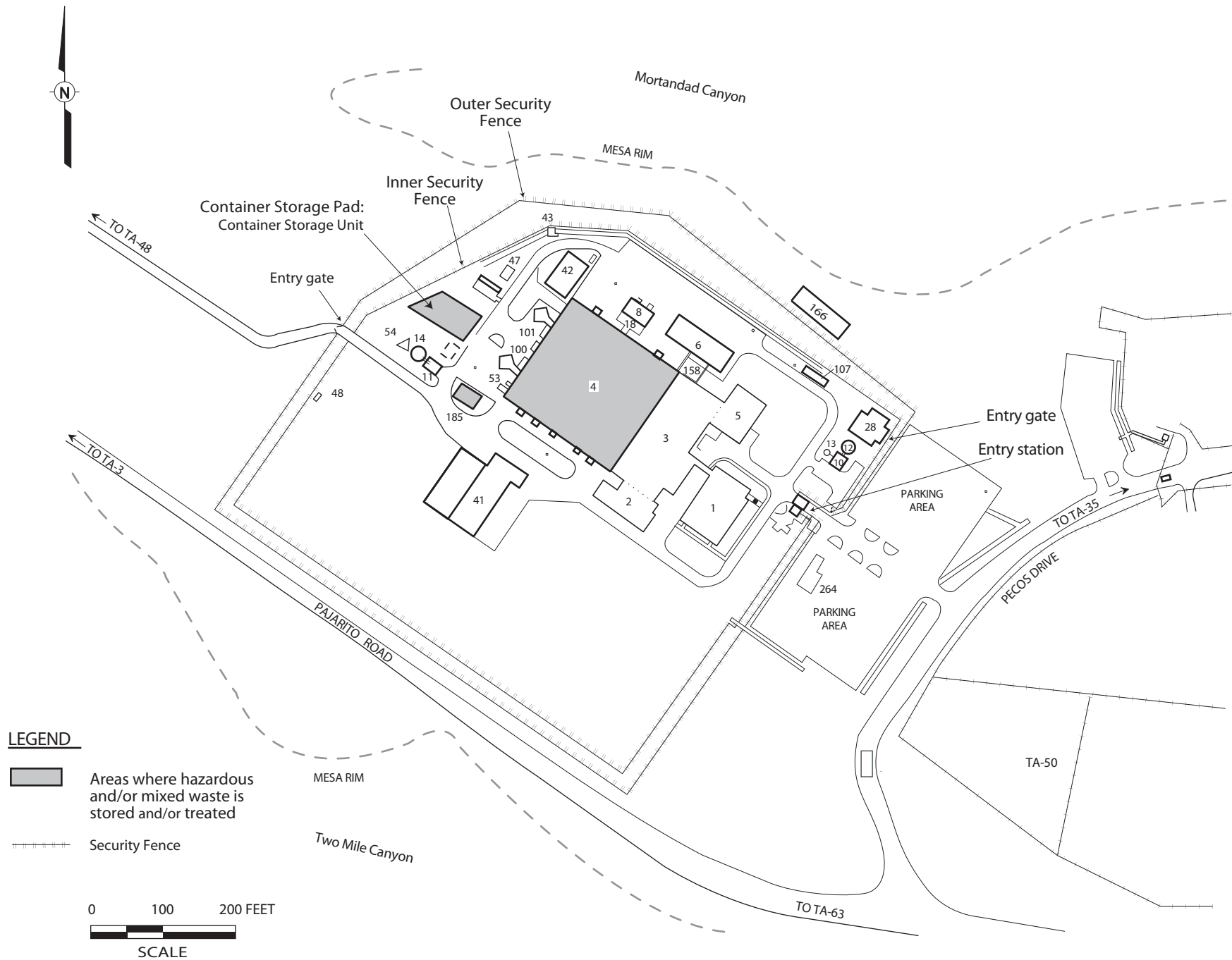

Figure 10
 Technical Area (TA) 55 Location Map Showing Security Fences, Entry Gates, and Entry Stations

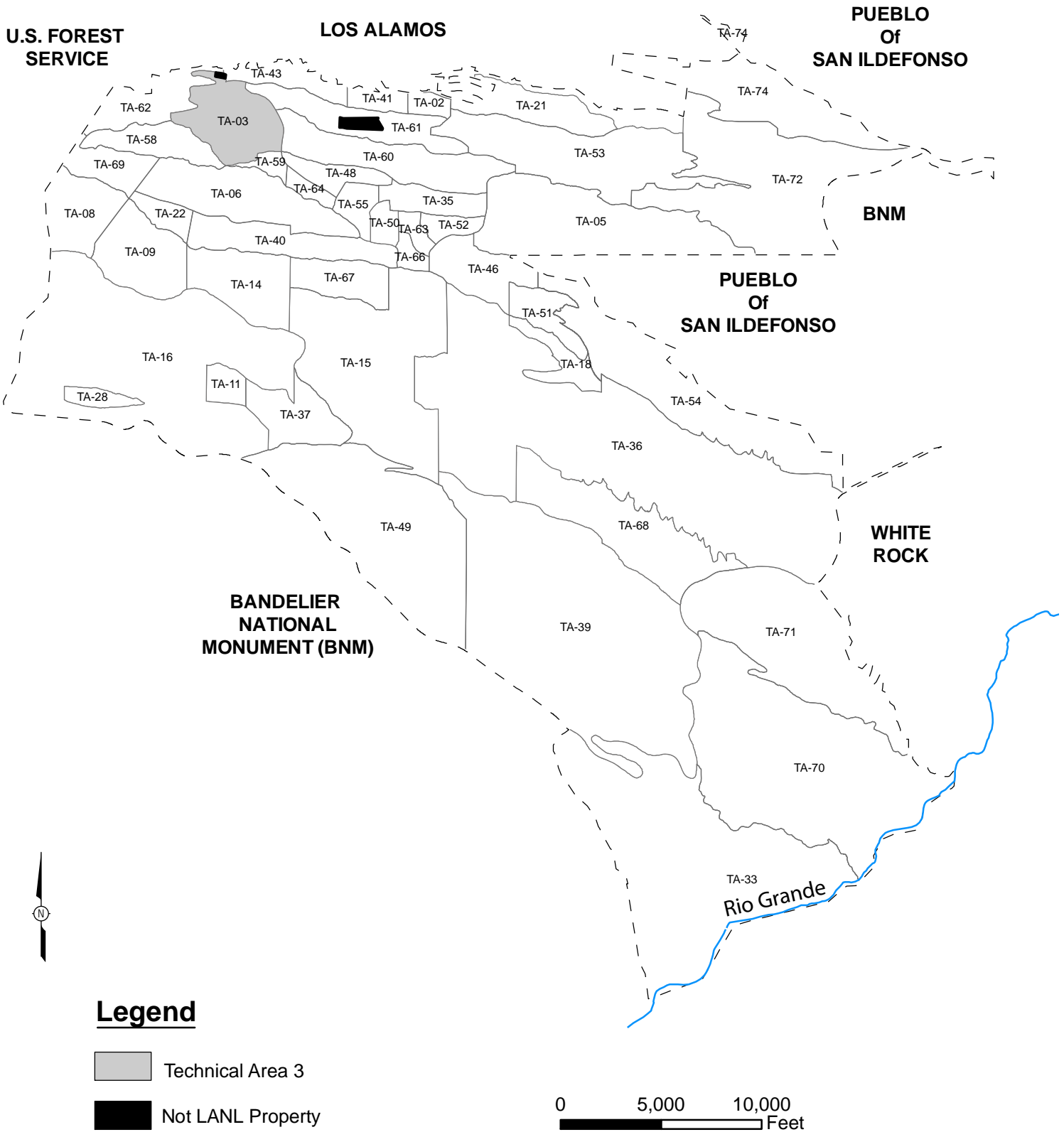

Figure 11:

Technical Area (TA) 3 Location Map

Created by EP-WES-EDA GIS TEAM. Map Number 06-0108 November 13, 2008, modified by ENV-RCRA August 2009
 State Plane Coordinate System New Mexico Central Zone North American Datum 1983 (ft)
 This map was created for work processes associated with the Environmental & Remediation Support Services. All other uses for this map should be confirmed with LANL EP-WES staff.
 Boundary of Department of Energy Property I Around the Los Alamos National Laboratory; Los Alamos National Laboratory, SSMO Site Planning & Project Initiation; infrastructure Planning Office. 04 June 2008
 Boundary of Department of Energy Property In and Around the Los Alamos National Laboratory; Los Alamos National Laboratory, SSMO Site Planning & Project Initiation; 04 June 2008

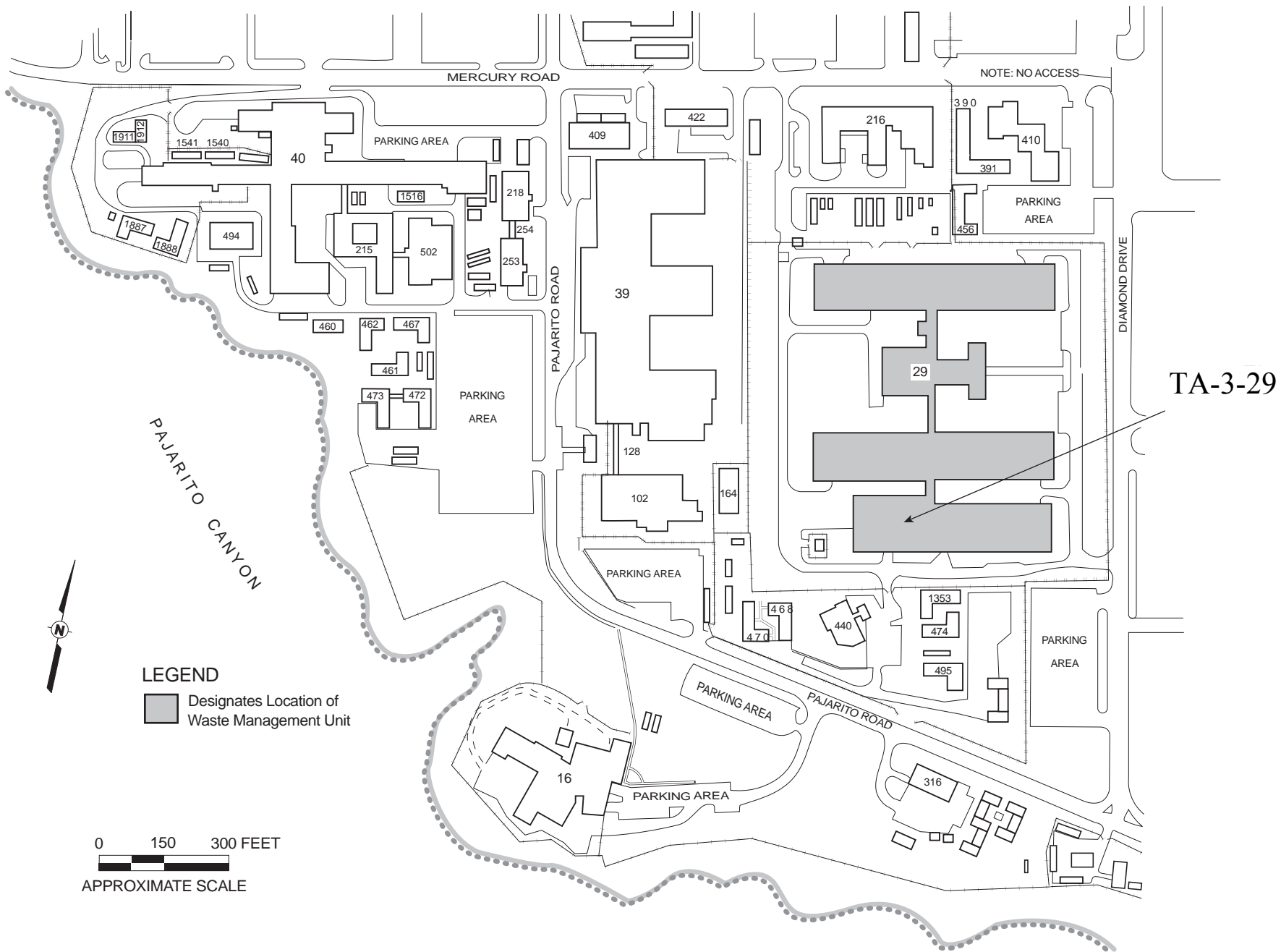
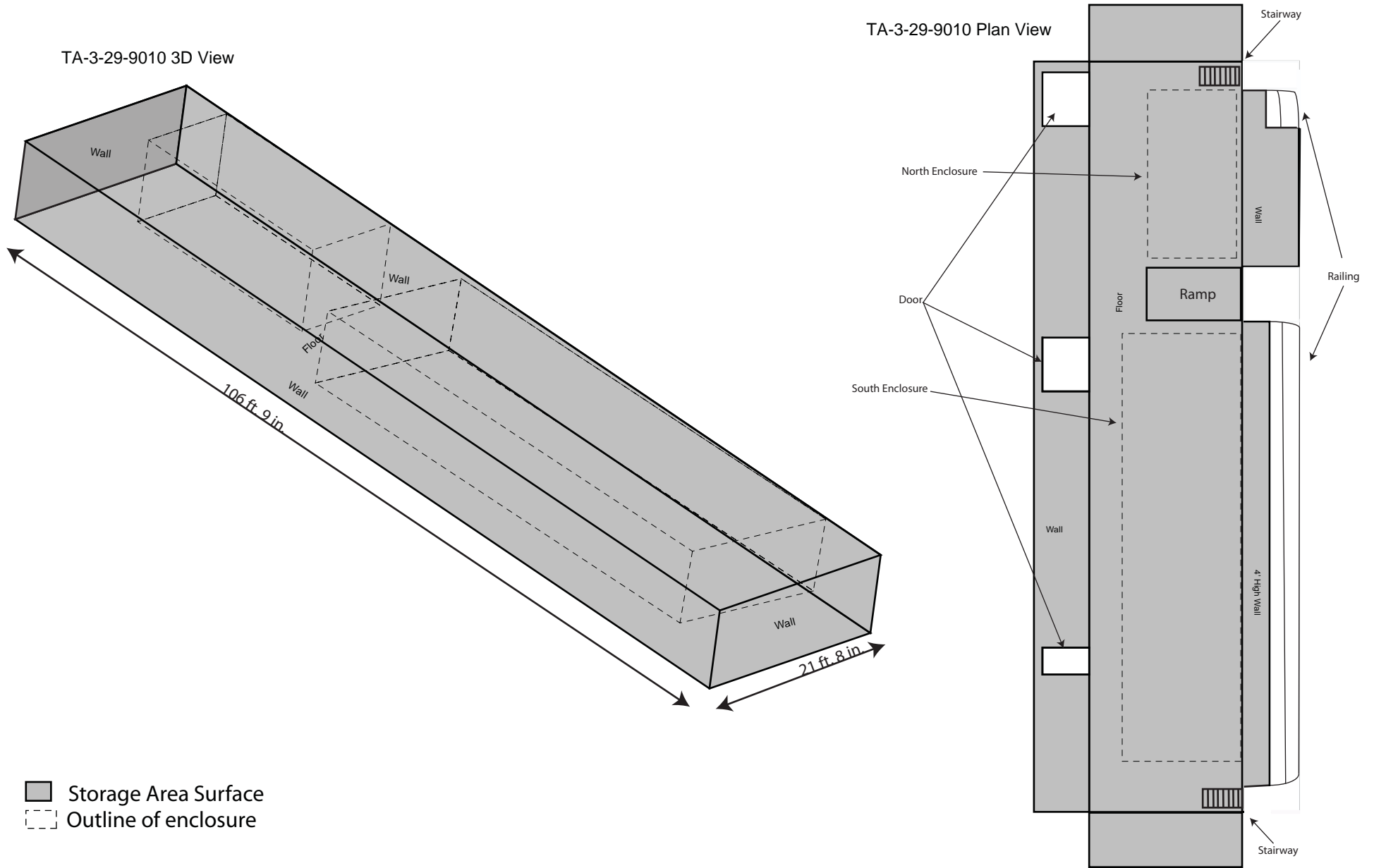

Figure 12:
 Technical Area (TA) 3, Building 29, Location Map



Not to scale

Figure 13:
 Technical Area (TA) 3, Building 29, Room 9010

Room 9020 Three-Dimensional View

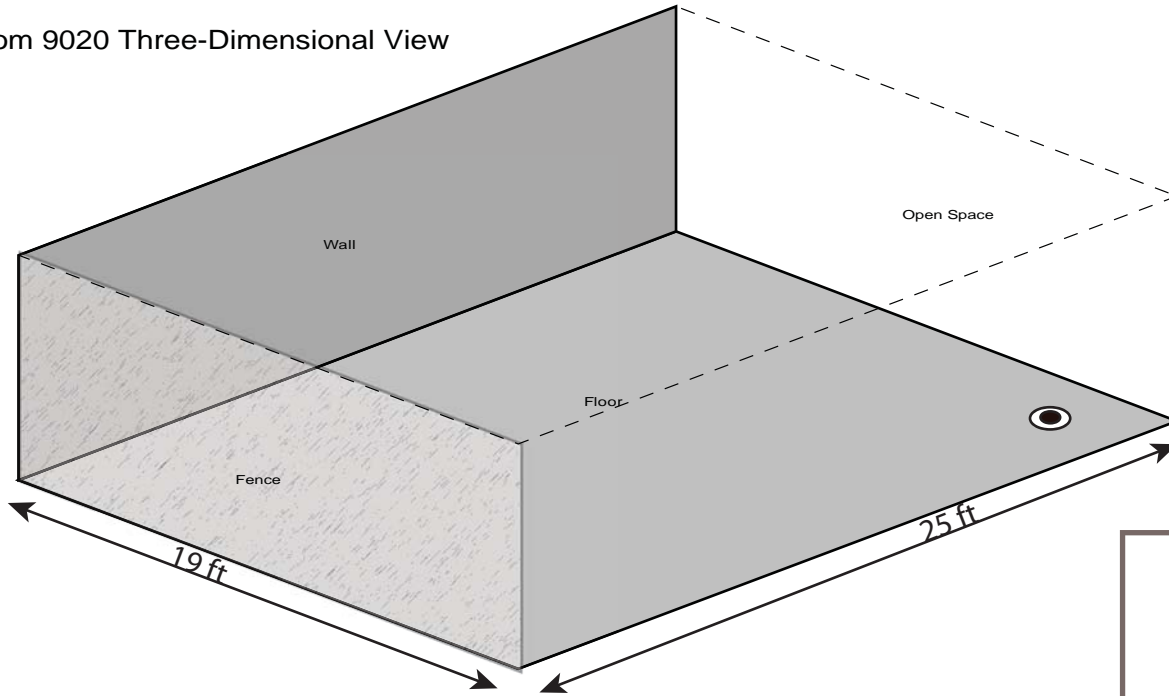

Room 9020 Plan View

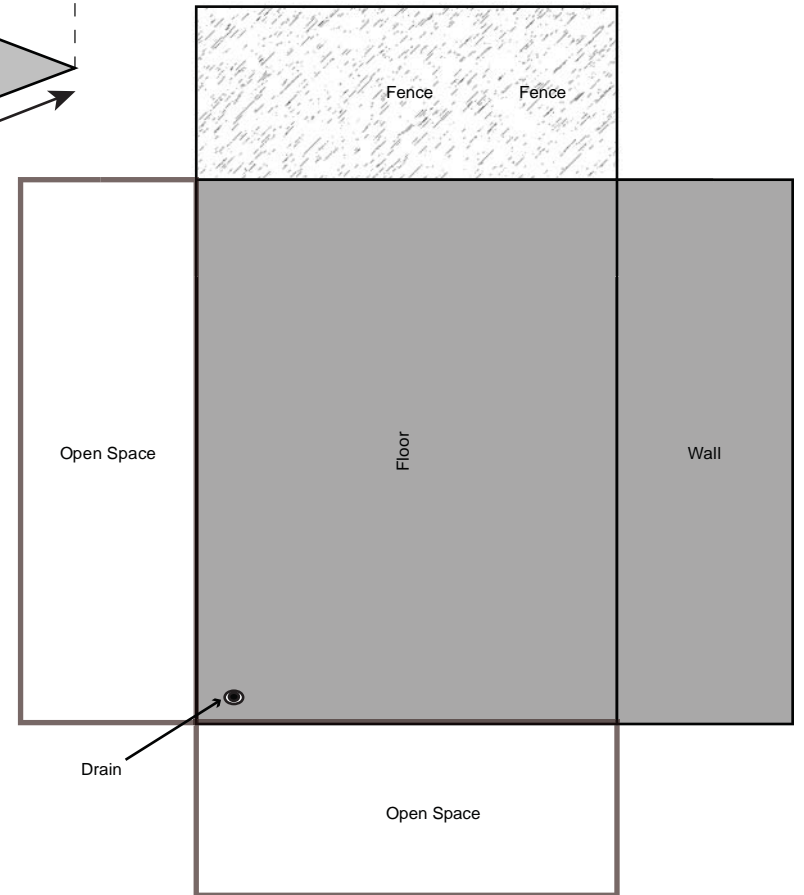

- Storage Area Surface
- ▨ Chainlink fence
- Drain

Not to scale

Figure 14:
Technical Area (TA) 3, Building 29, Portion of Room 9020

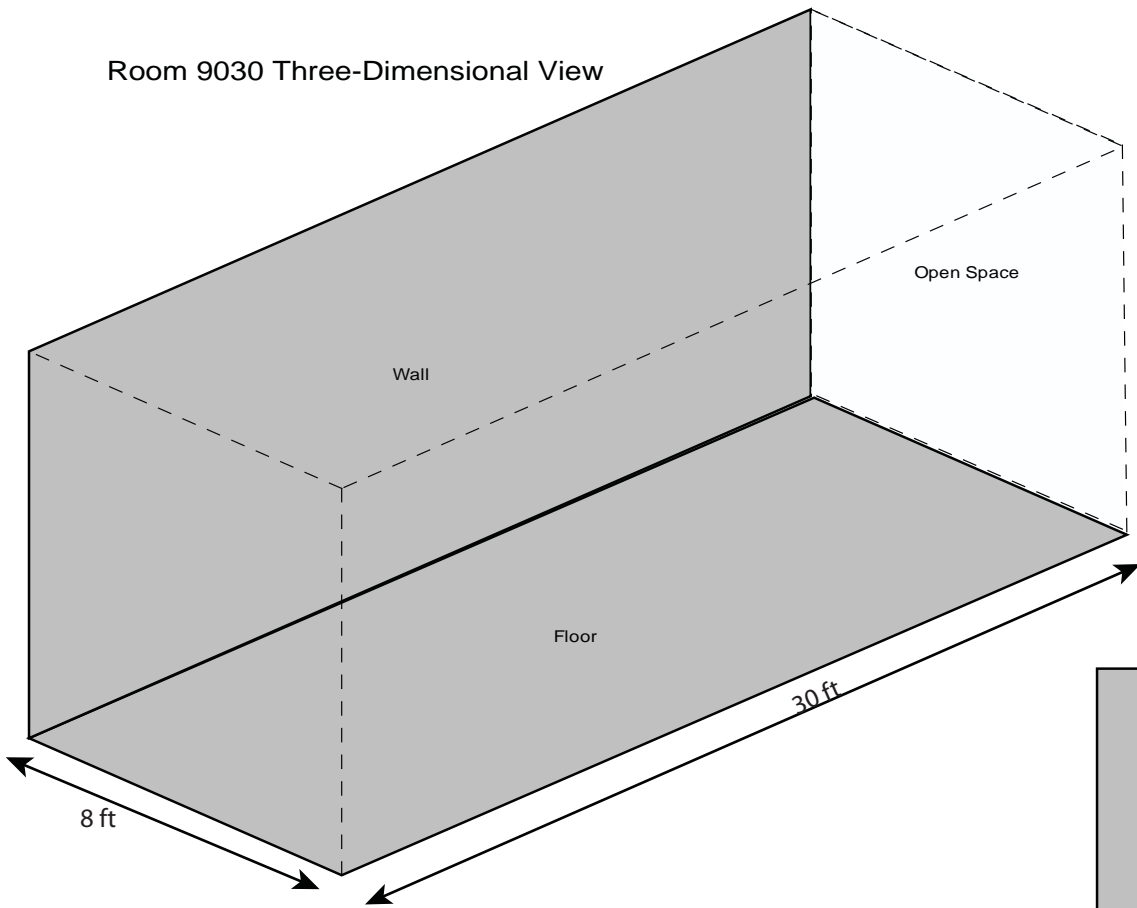

Not to scale

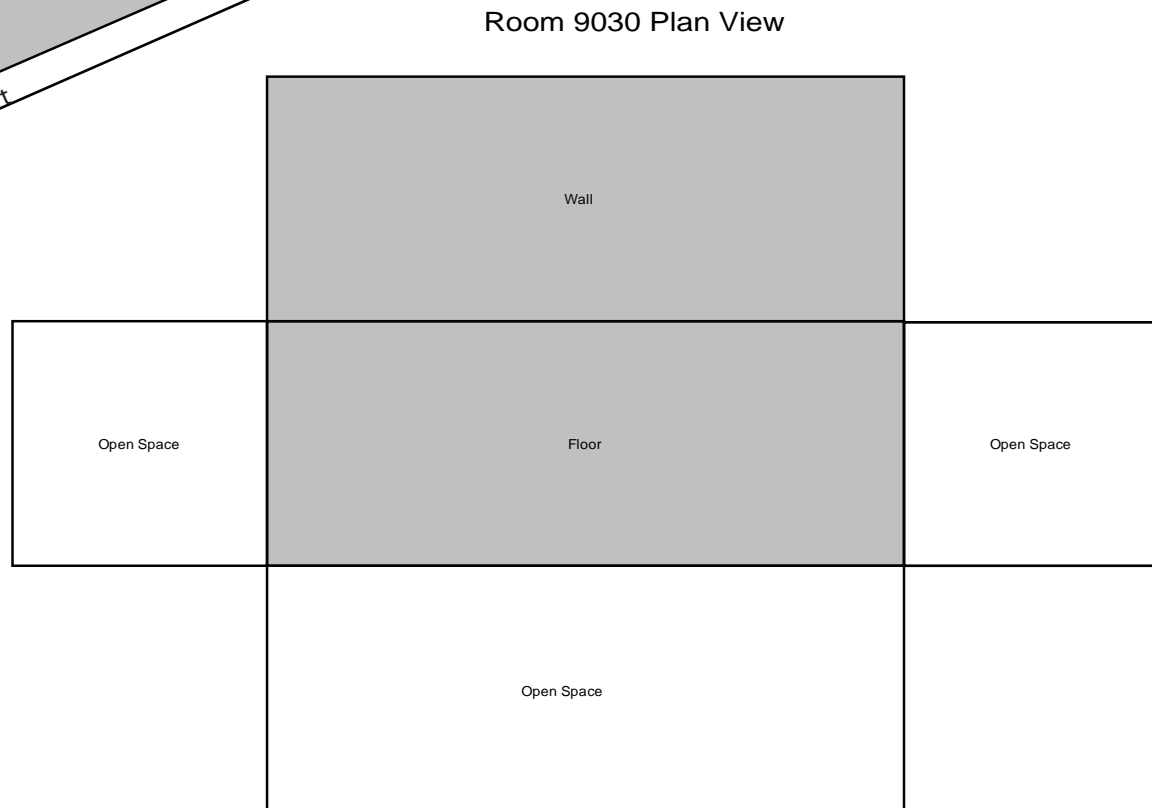

 Storage Area Surface

Figure 15:
Technical Area 3, Building 29, Portion of Room 9030

FIGURE 16 – RESERVED

FIGURE 17 – RESERVED

FIGURE 18 – RESERVED

FIGURE 19 – RESERVED

FIGURE 20 – RESERVED

FIGURE 21 – RESERVED

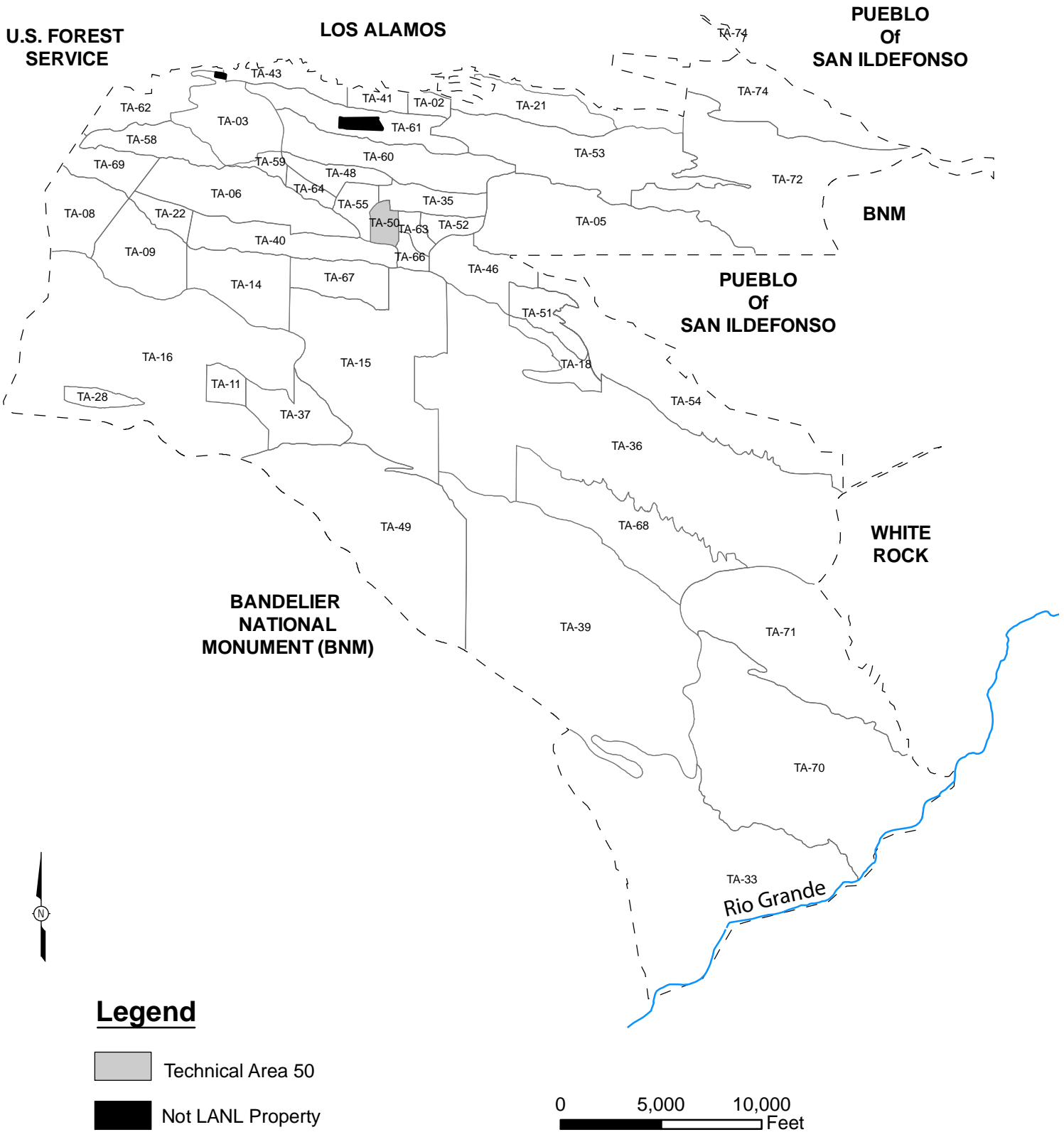
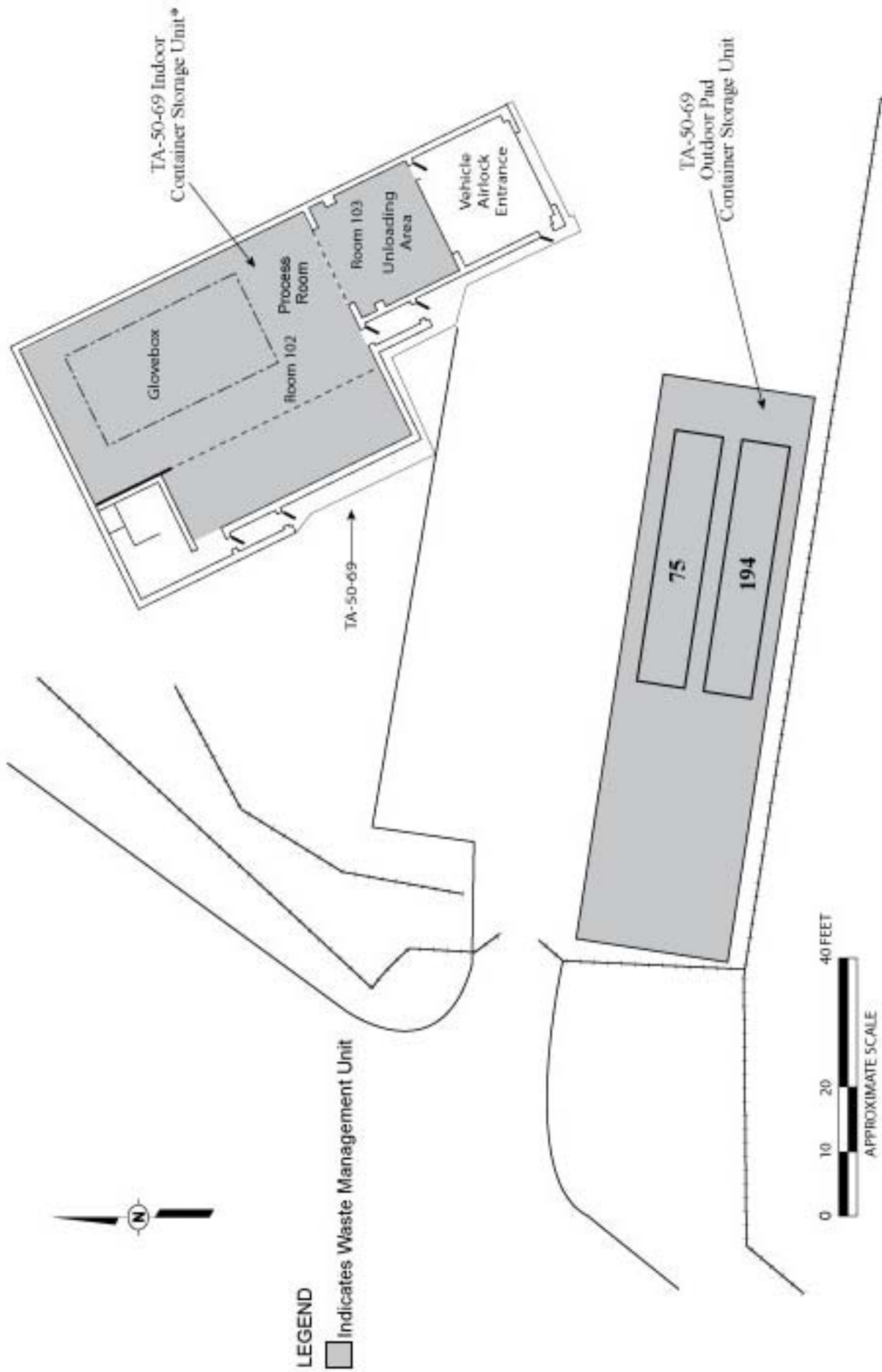

Figure 22:

Technical Area (TA) 50 Location Map

Created by EP-WES-EDA GIS TEAM. Map Number 06-0108 November 13, 2008, modified by ENV-RCRA August 2009
 State Plane Coordinate System New Mexico Central Zone North American Datum 1983 (ft)
 This map was created for work processes associated with the Environmental & Remediation Support Services. All other uses for this map should be confirmed with LANL EP-WES staff.
 Boundary of Department of Energy Property I Around the Los Alamos National Laboratory; Los Alamos National Laboratory, SSMO Site Planning & Project Initiation; infrastructure Planning Office. 04 June 2008
 Boundary of Department of Energy Property In and Around the Los Alamos National Laboratory; Los Alamos National Laboratory, SSMO Site Planning & Project Initiation; 04 June 2008



*Note: Container Storage Area in Building 69 does not include mezzanine.

Figure 23
 Technical Area (TA) 50, Building 69, Indoor and Outdoor Container Storage Units

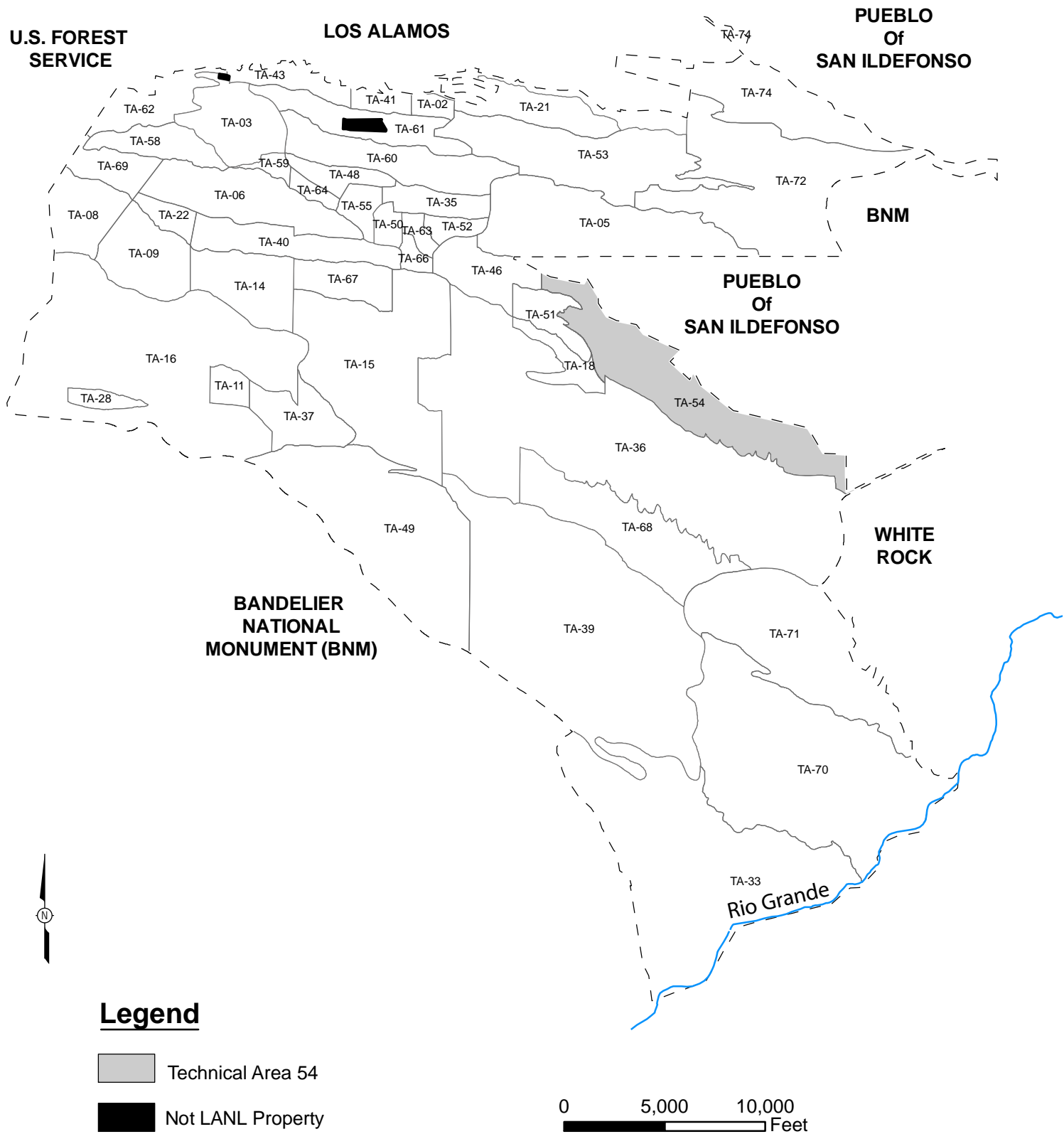

Figure 24:
 Technical Area (TA) 54 Location Map

Created by EP-WES-EDA GIS TEAM. Map Number 06-0108 November 13, 2008, modified by ENV-RCRA August 2009
 State Plane Coordinate System New Mexico Central Zone North American Datum 1983 (ft)
 This map was created for work processes associated with the Environmental & Remediation Support Services. All other uses for this map should be confirmed with LANL EP-WES staff.
 Boundary of Department of Energy Property I Around the Los Alamos National Laboratory; Los Alamos National Laboratory, SSMO Site Planning & Project Initiation; Infrastructure Planning Office. 04 June 2008
 Boundary of Department of Energy Property In and Around the Los Alamos National Laboratory; Los Alamos National Laboratory, SSMO Site Planning & Project Initiation; 04 June 2008

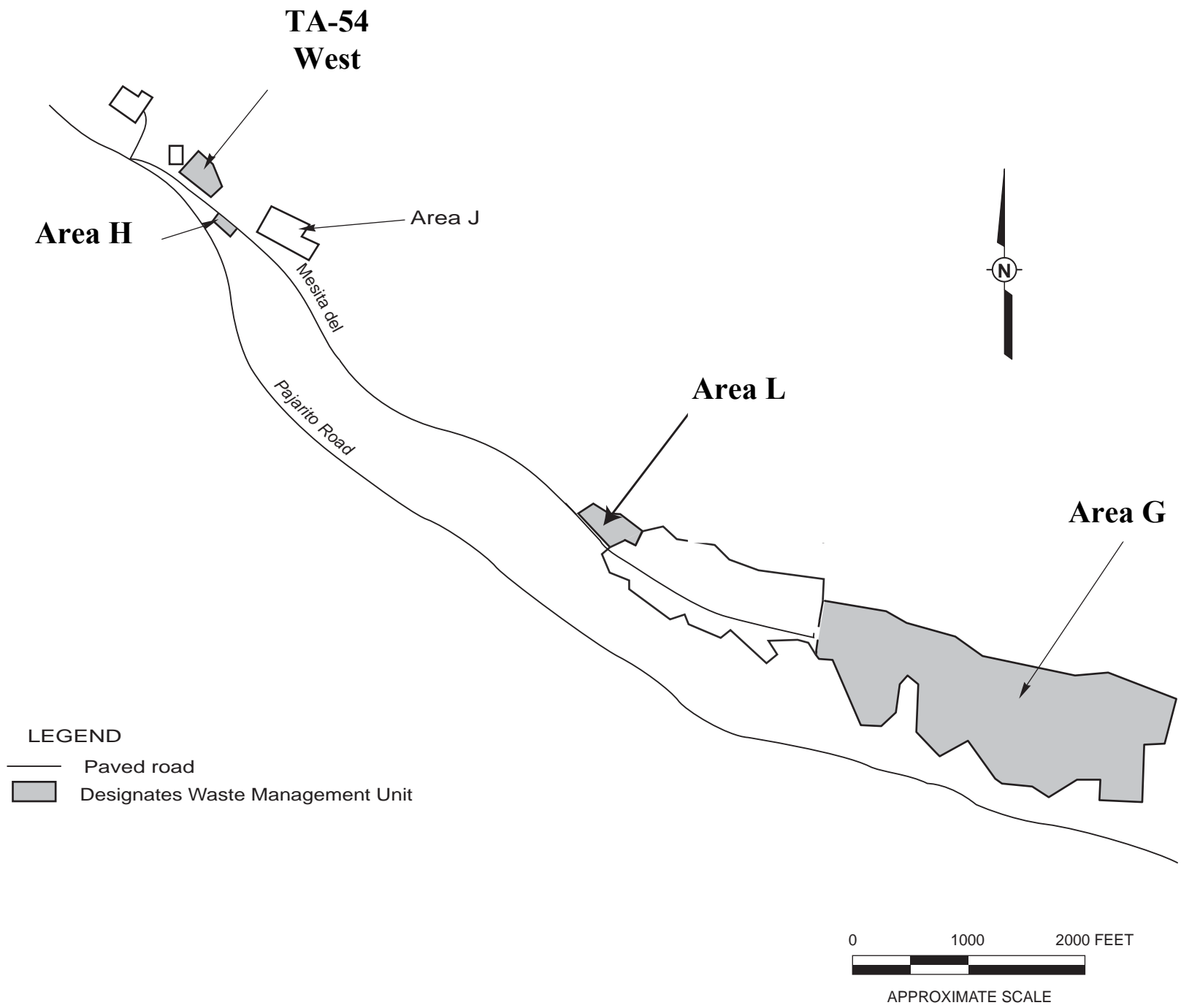

Figure 25
 Technical Area (TA)-54, Areas G, H, L, and TA-54 West Location Map

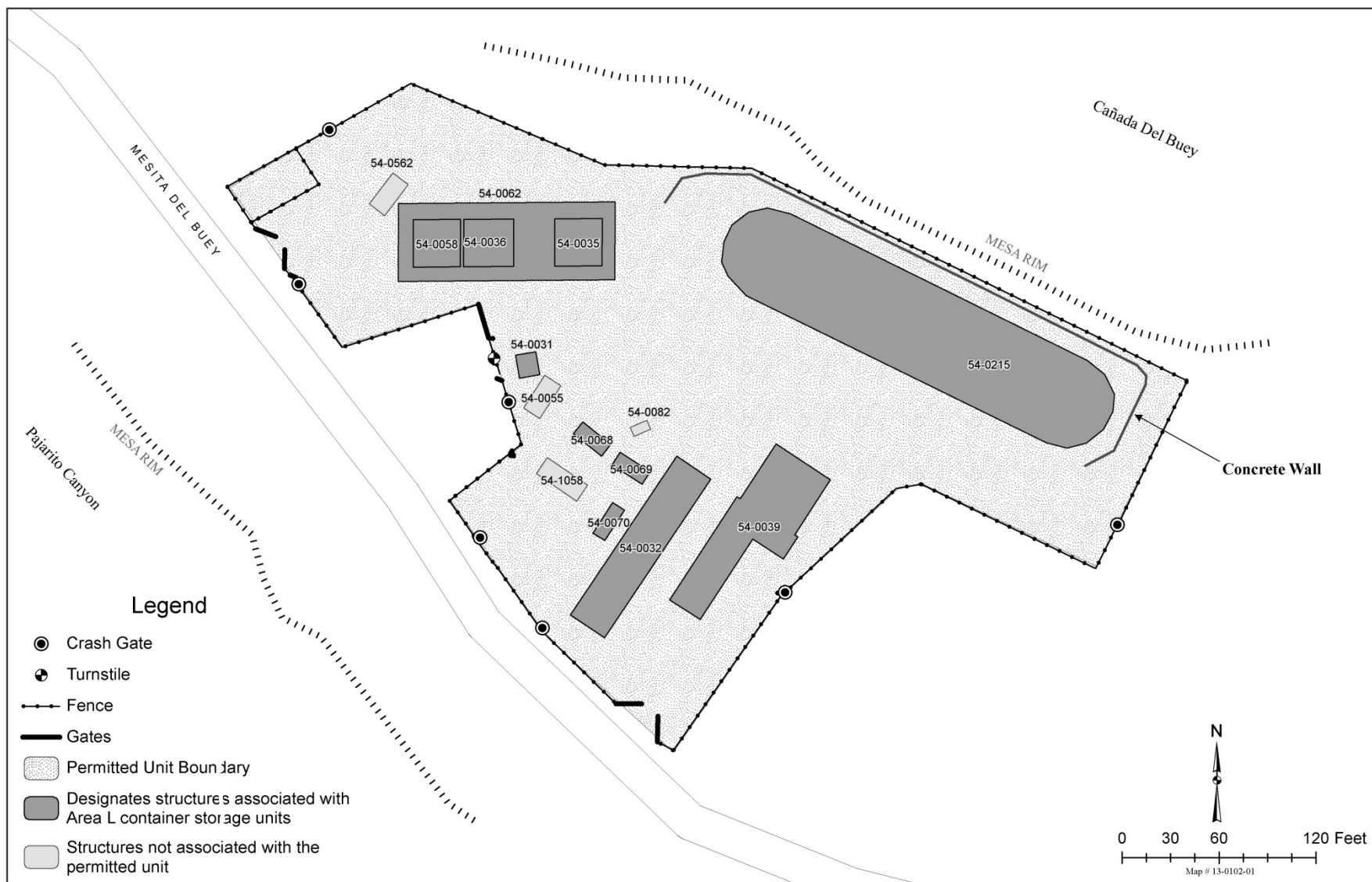

Figure 26: Technical Area 54, Area L, Container Storage Unit

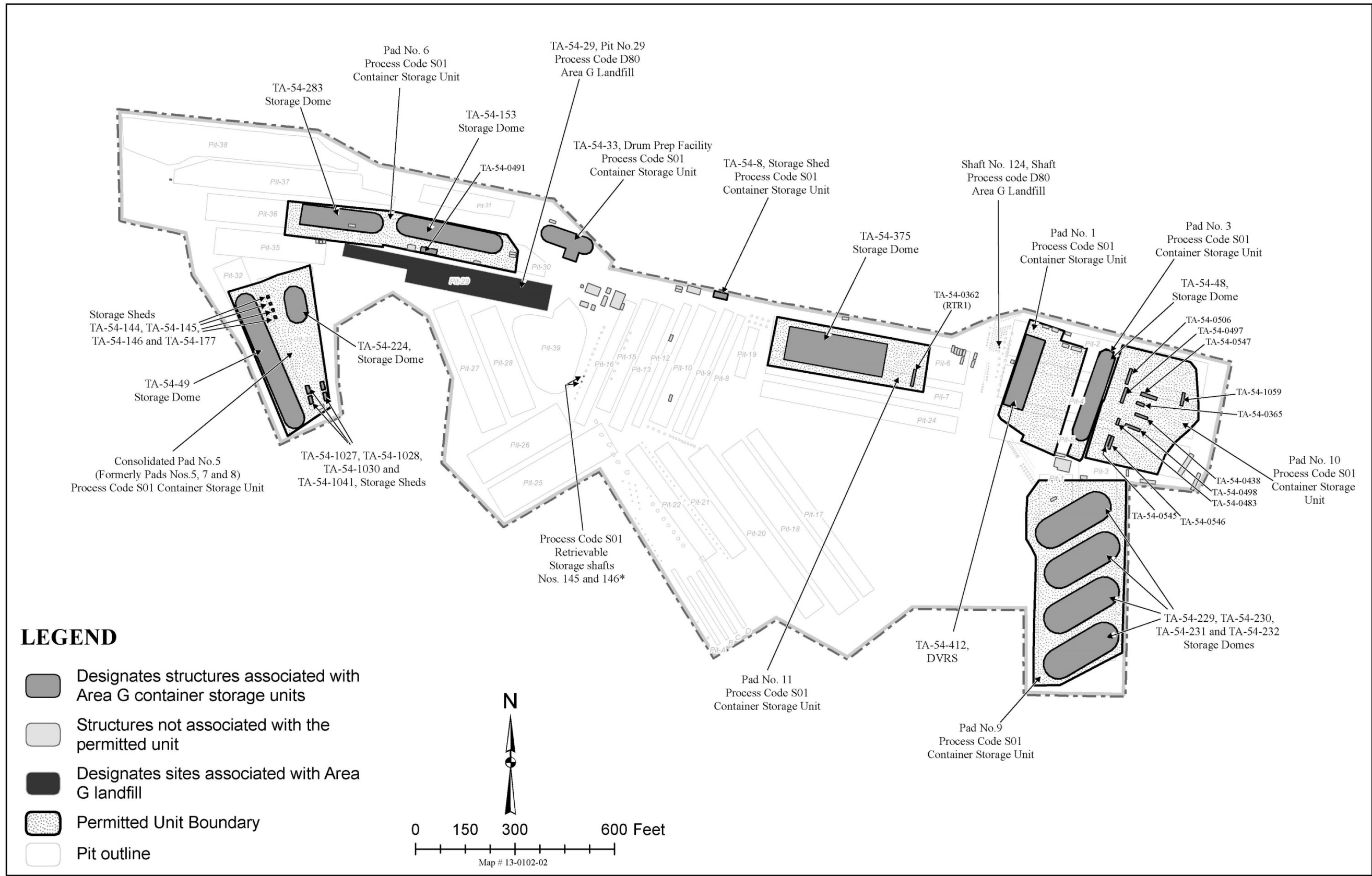

Figure 27: Technical Area 54, Area G, Container Storage Units

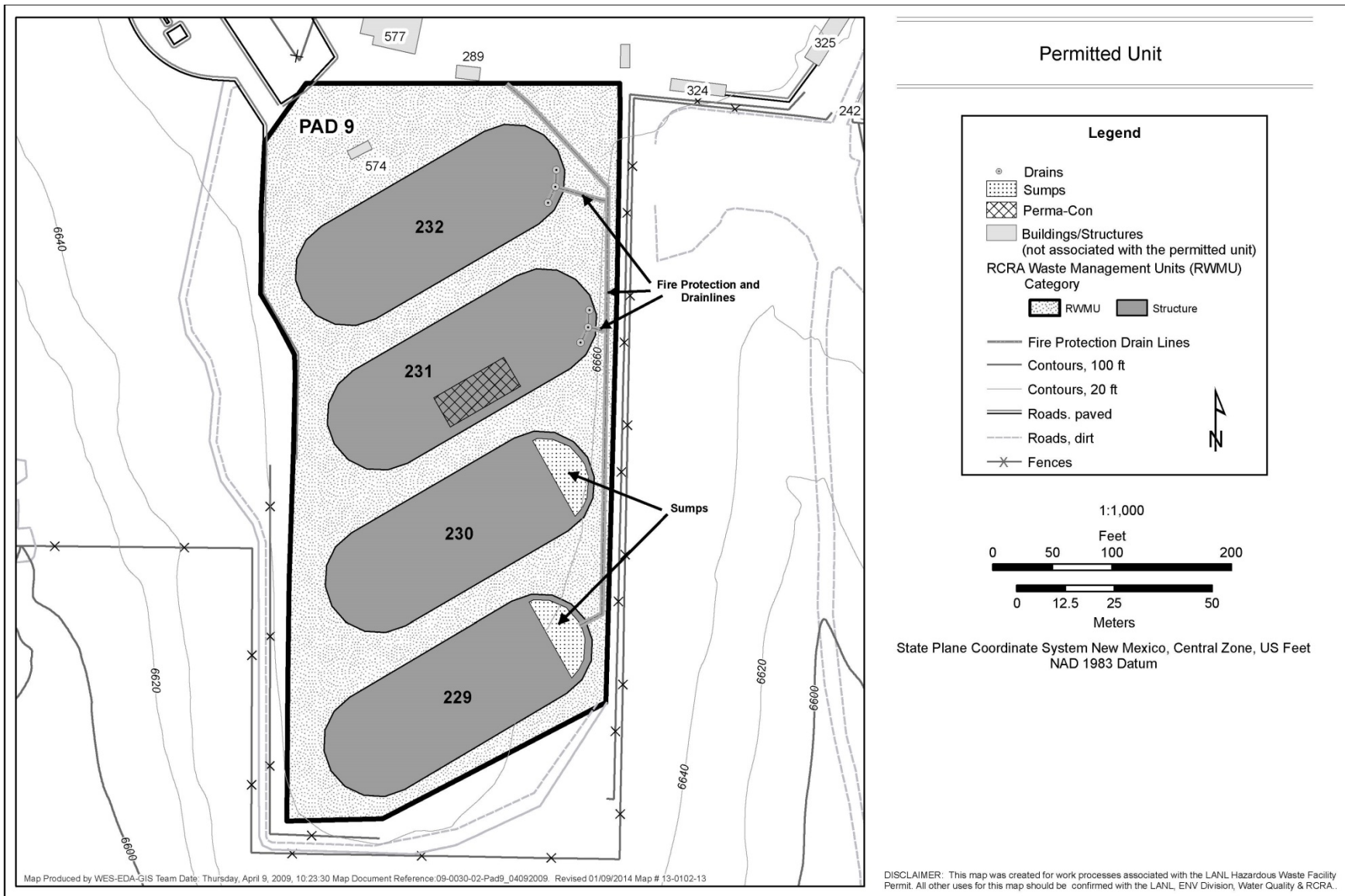
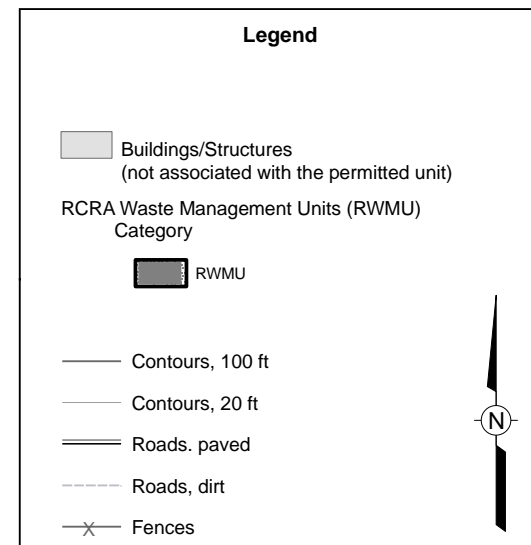
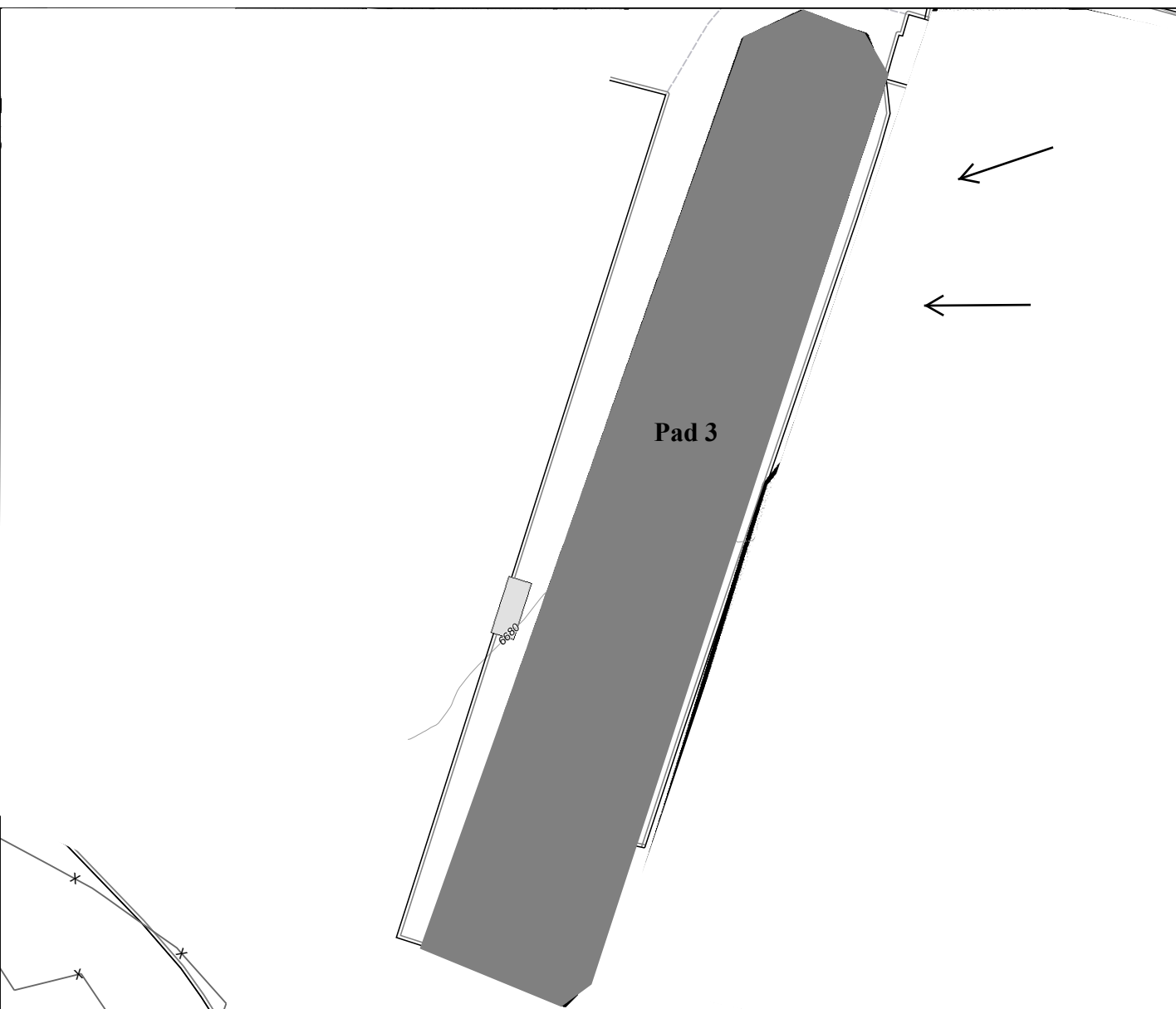
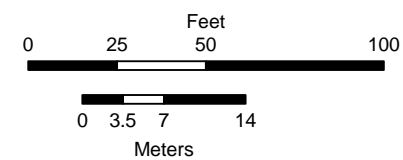

Figure 28: Technical Area (TA)-54, Area G, Pad 9 (TWISP Domes 229, 230, 231 & 232)



1:475



State Plane Coordinate System New Mexico, Central Zone, US Feet
NAD 1983 Datum

DISCLAIMER: This map was created for work processes associated with the LANL Hazardous Waste Facility Permit. All other uses for this map should be confirmed with the LANL, ENV Division, Water Quality & RCRA.

Figure 30:
Technical Area (TA)-54, Area G, Pad 3

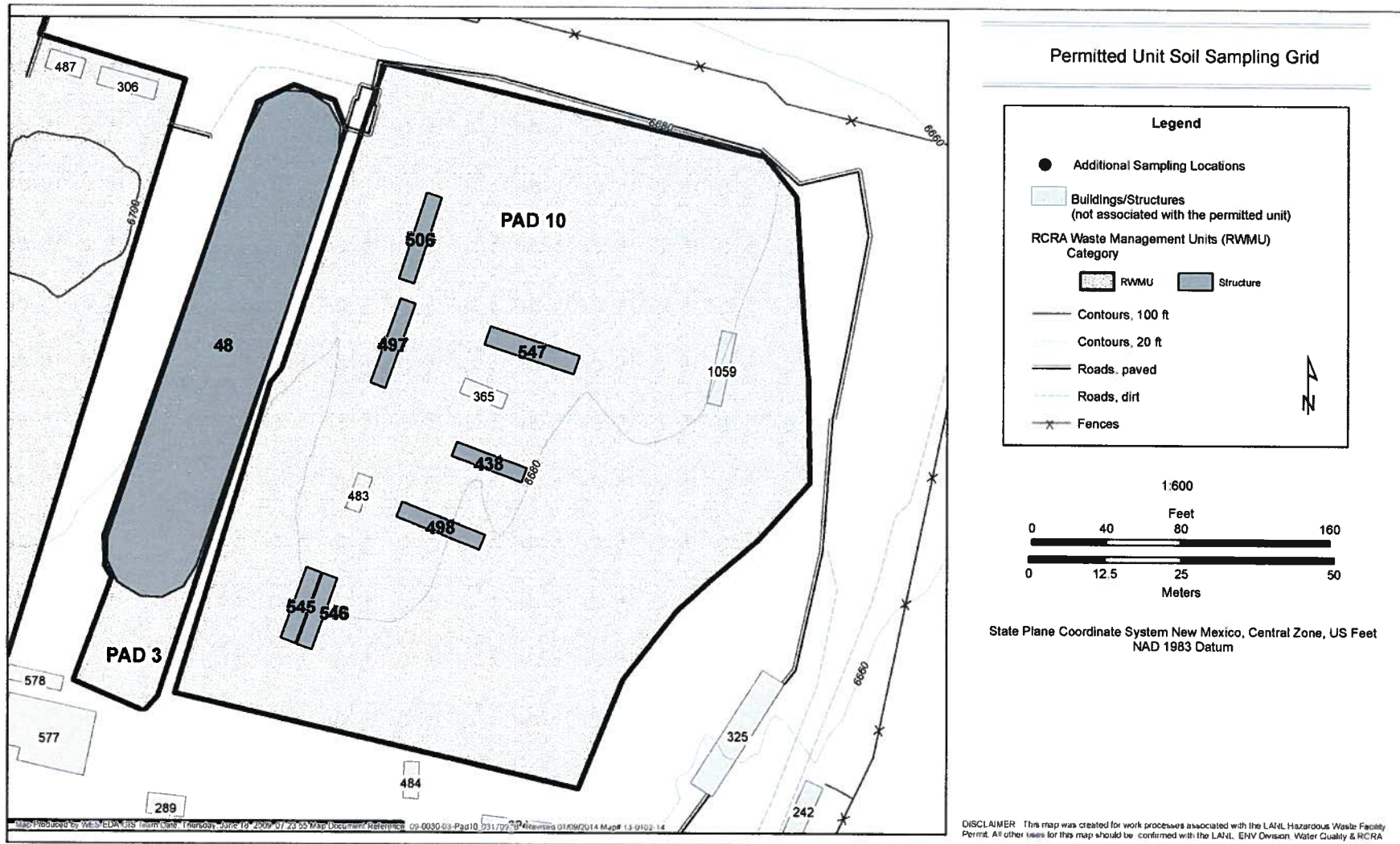

Figure 31: TA-54, Area G, Pad 10

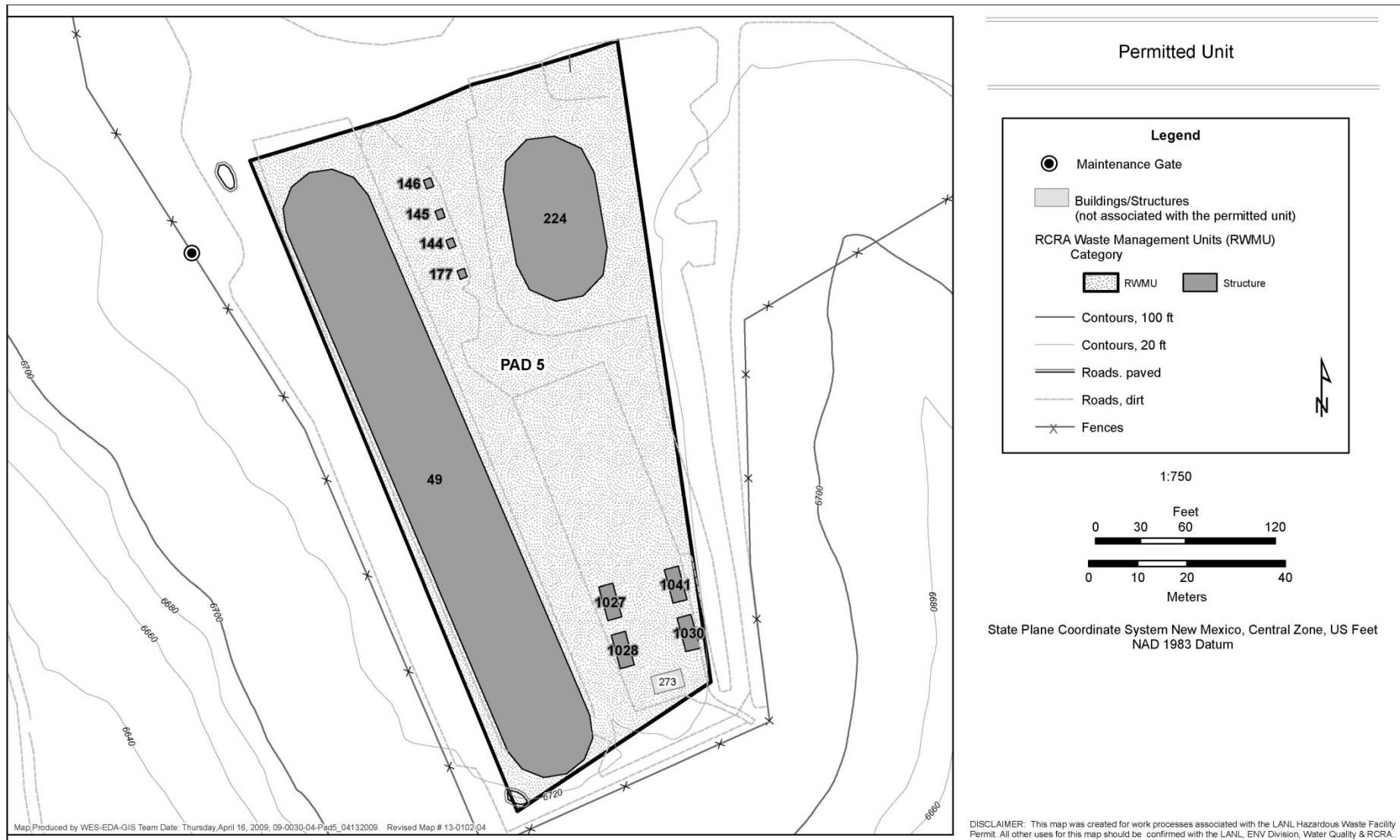
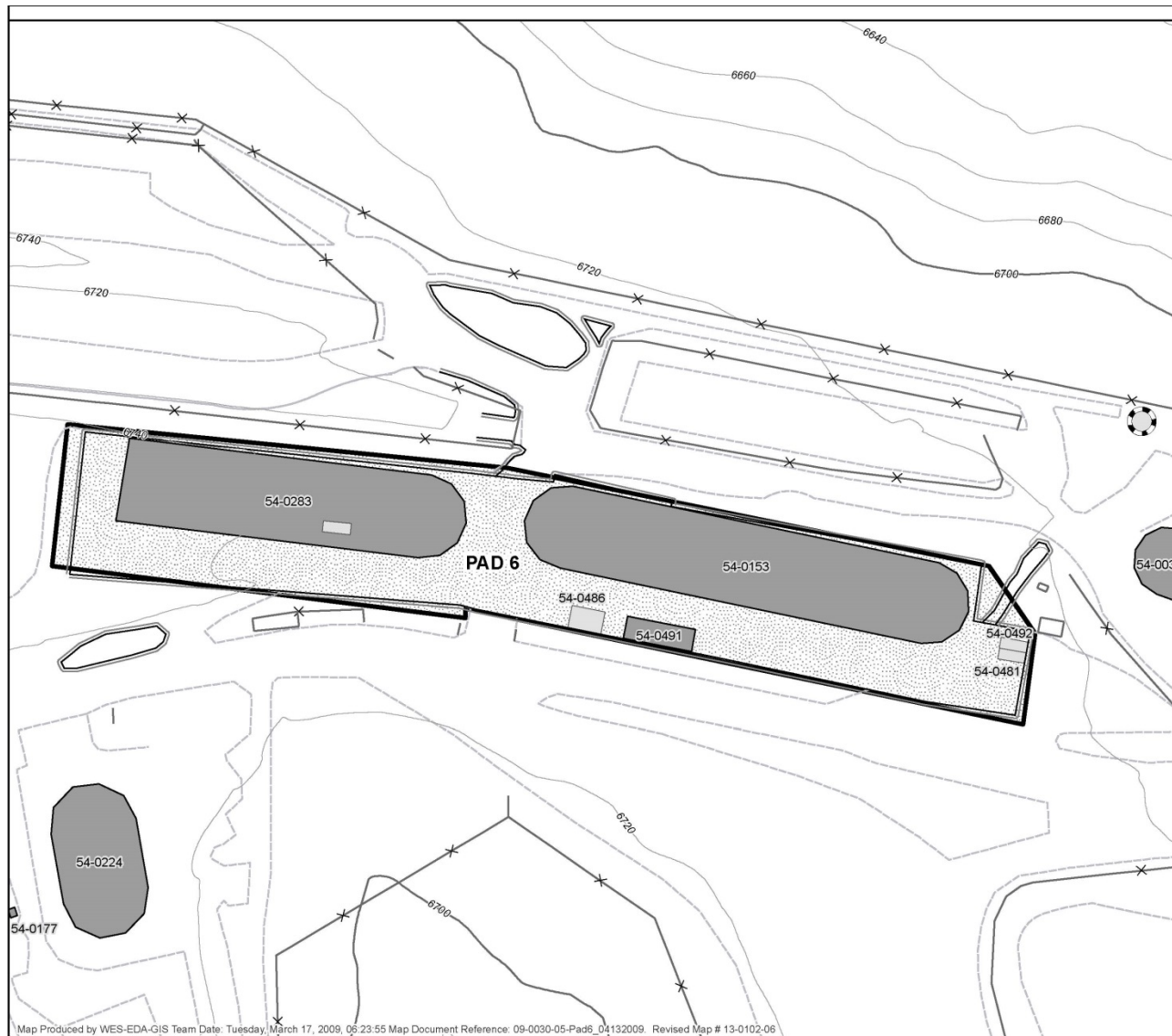
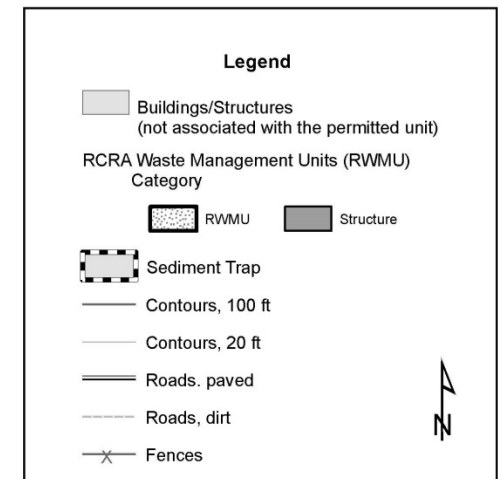

Figure 32: Technical Area (TA)-54, Area G, Pad 5 (Domes 49 and 224; Storage Sheds 144, 145, 146, 177, 1027, 1028, 1030, and 1041)



Permitted Unit



1:1,000

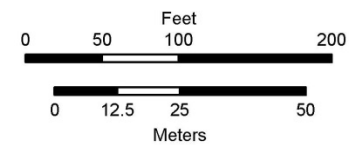

State Plane Coordinate System New Mexico, Central Zone, US Feet
NAD 1983 Datum

Map Produced by WES-EDA-GIS Team Date: Tuesday, March 17, 2009, 06:23:55 Map Document Reference: 09-0030-05-Pad6_04132009. Revised Map # 13-0102-06

DISCLAIMER: This map was created for work processes associated with the LANL Hazardous Waste Facility Permit. All other uses for this map should be confirmed with the LANL, ENV Division, Water Quality & RCRA.

Figure 33: Technical Area (TA)-54, Area G, Pad 6, (Domes 153 & 283)



Permitted Unit

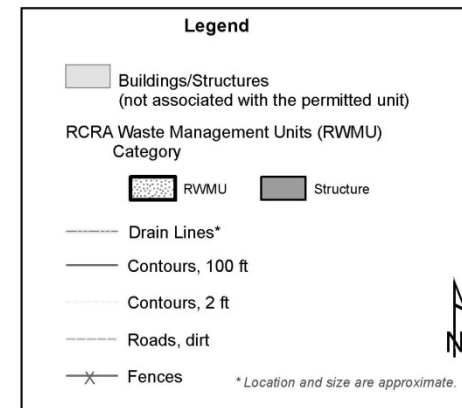

1:230

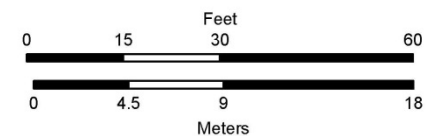

State Plane Coordinate System New Mexico, Central Zone, US Feet
NAD 1983 Datum

DISCLAIMER: This map was created for work processes associated with the LANL Hazardous Waste Facility Permit. All other uses for this map should be confirmed with the LANL, ENV Division, Water Quality & RCRA.

Figure 34: Technical Area (TA)-54, Area G, Storage Shed 8

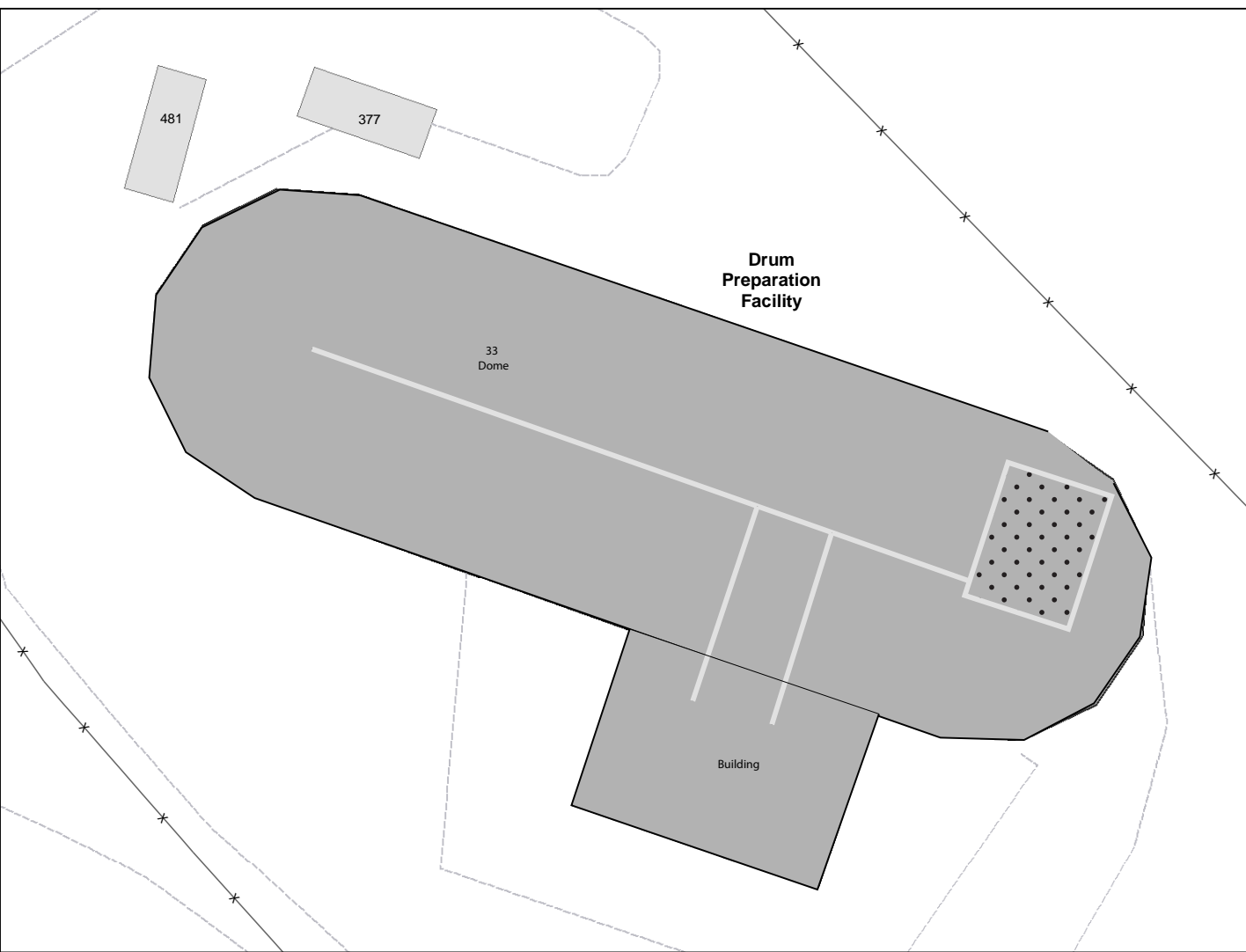

Legend

- Sumps*
- Buildings/Structures (not associated with the permitted unit)

RCRA Waste Management Units (RWMU) Category

- RWMU
- Structure

- Drain Lines*
- Contours, 100 ft
- Contours, 20 ft
- Roads, paved
- Roads, dirt
- Fences

* Location and size are approximate.

1:230

0 15 30 60
Feet

0 4.5 9 18
Meters

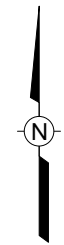

State Plane Coordinate System New Mexico, Central Zone, US Feet
NAD 1983 Datum

DISCLAIMER: This map was created for work processes associated with the LANL Hazardous Waste Facility Permit. All other uses for this map should be confirmed with the LANL, ENV Division, Water Quality & RCRA..

Figure 35
Technical Area (TA)-54, Area G, Building 33

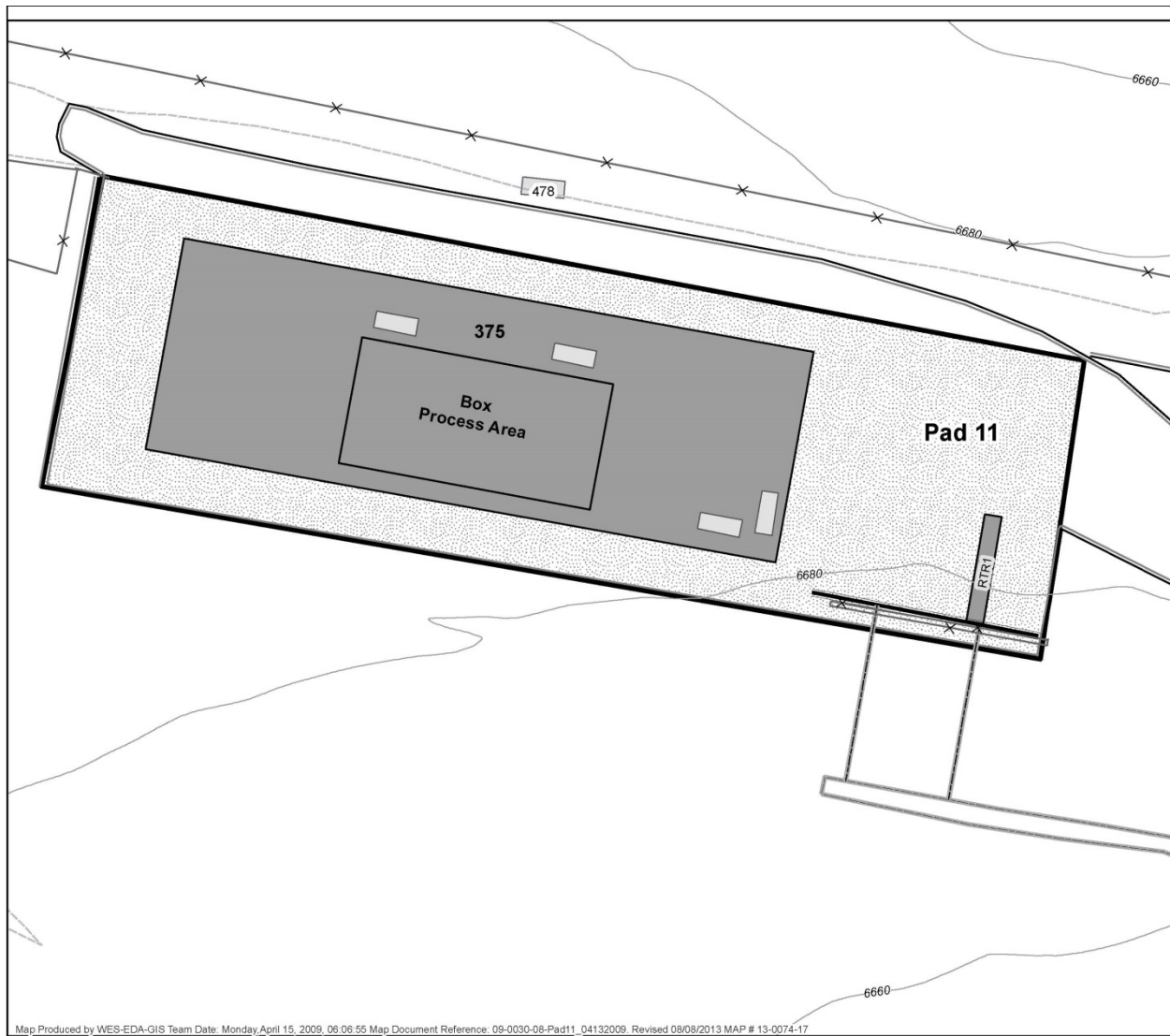

Permitted Unit Soil Sampling Grid

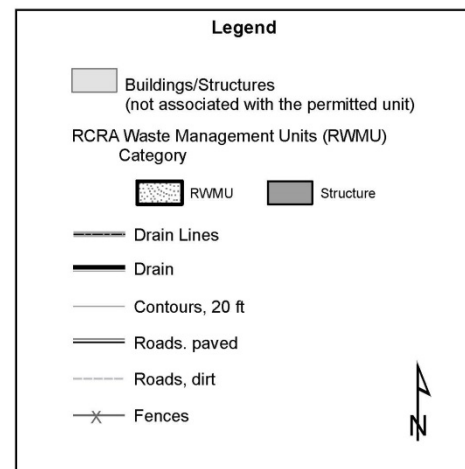

1:650

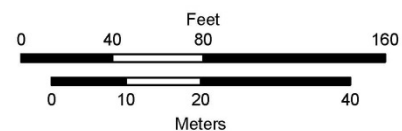

State Plane Coordinate System New Mexico, Central Zone, US Feet
NAD 1983 Datum

Map Produced by WES-EDA-GIS Team Date: Monday, April 15, 2009, 06:06:55 Map Document Reference: 09-0030-08-Pad11_04132009. Revised 08/08/2013 MAP # 13-0074-17

DISCLAIMER: This map was created for work processes associated with the LANL Hazardous Waste Facility Permit. All other uses for this map should be confirmed with the LANL, ENV Division, Water Quality & RCRA.

Figure 36: TA-54, Area G, Pad 11

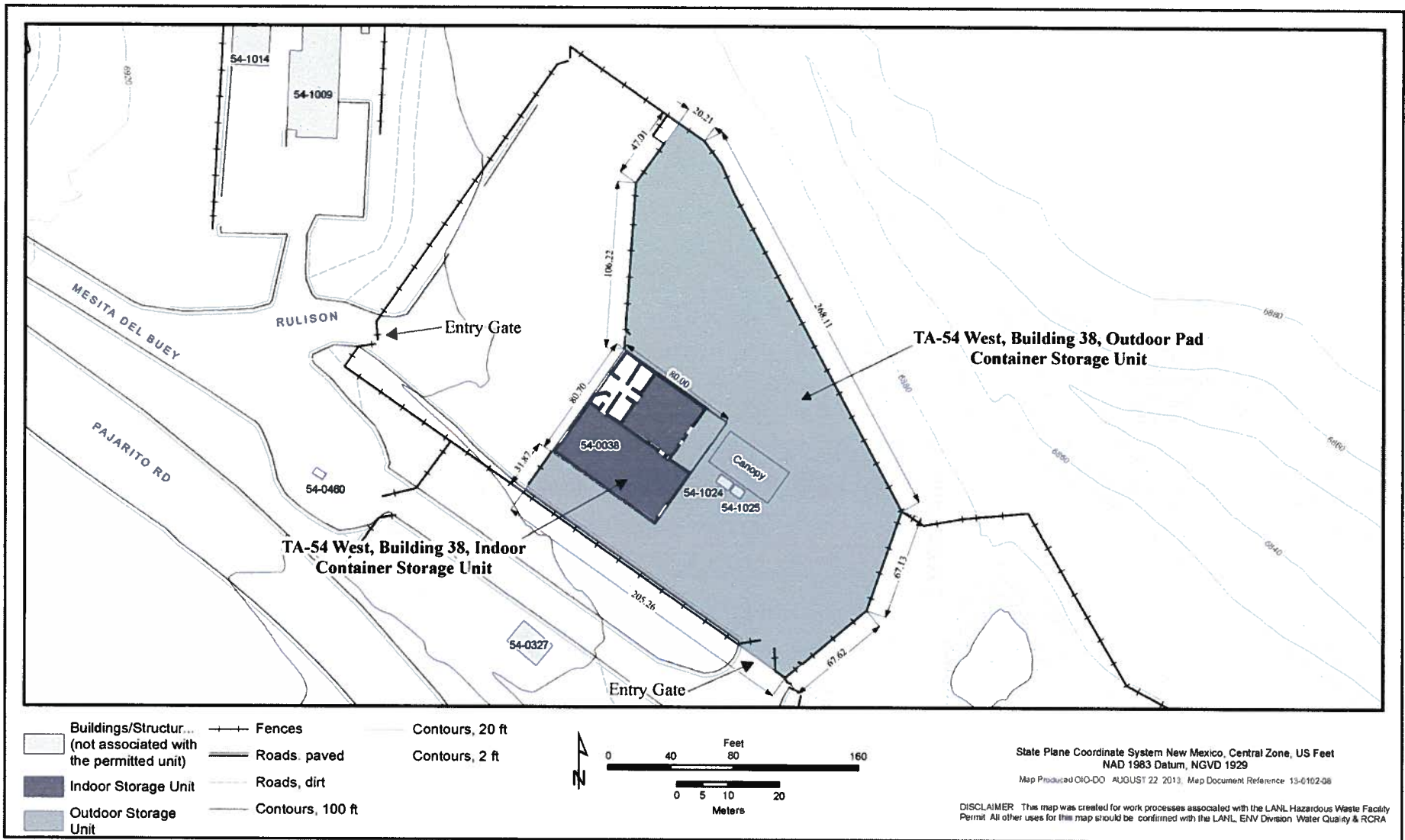

Figure 37: Technical Area (TA) 54 West, Building 38 Indoor (High Bay and Low Bay) and Outdoor Pad

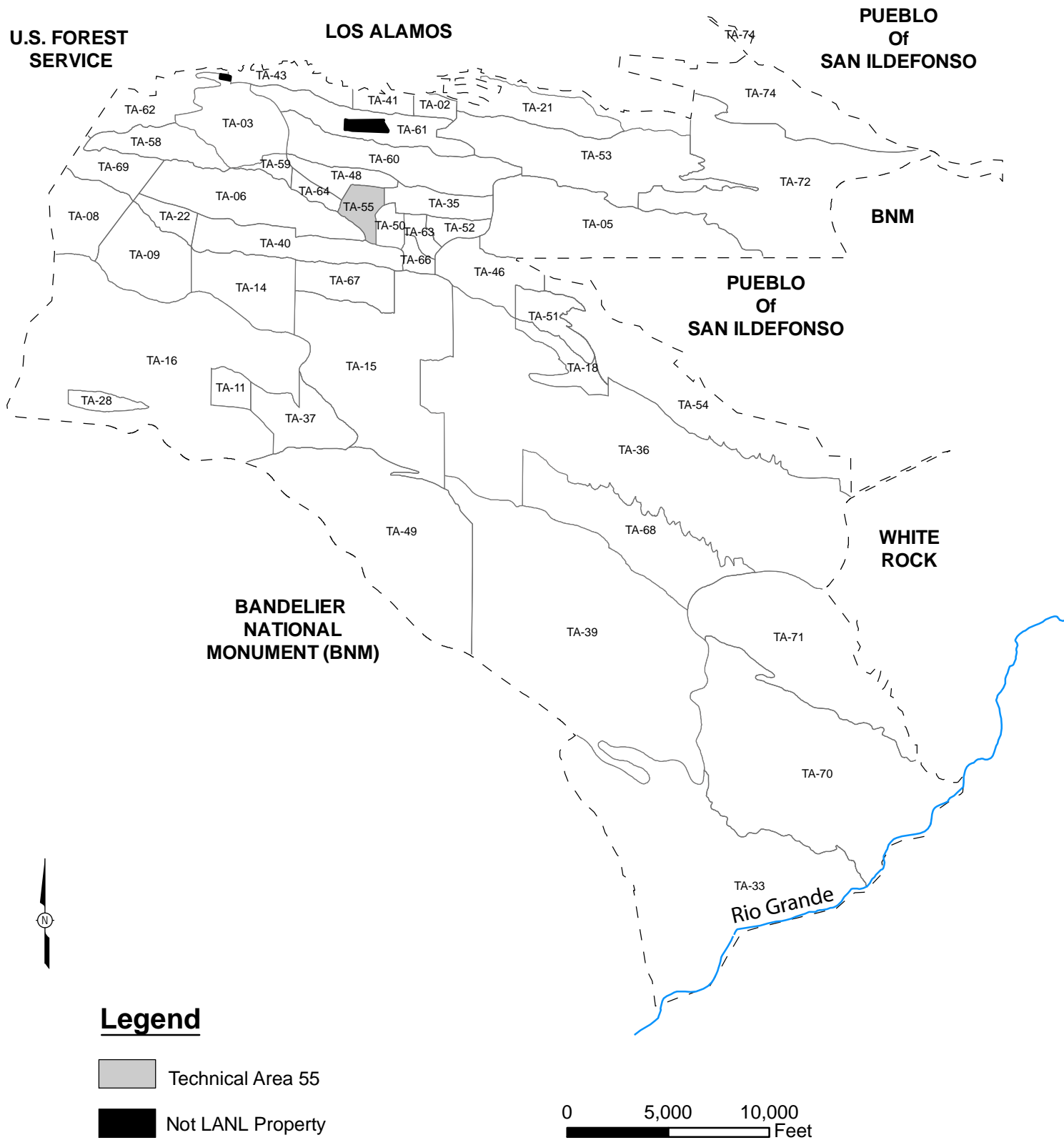

Figure 38:
 Technical Area (TA) 55 Location Map

Created by EP-WES-EDA GIS TEAM. Map Number 06-0108 November 13, 2008, modified by ENV-RCRA August 2009
 State Plane Coordinate System New Mexico Central Zone North American Datum 1983 (ft)
 This map was created for work processes associated with the Environmental & Remediation Support Services. All other uses for this map should be confirmed with LANL EP-WES staff.
 Boundary of Department of Energy Property I Around the Los Alamos National Laboratory; Los Alamos National Laboratory, SSMO Site Planning & Project Initiation; Infrastructure Planning Office. 04 June 2008
 Boundary of Department of Energy Property In and Around the Los Alamos National Laboratory; Los Alamos National Laboratory, SSMO Site Planning & Project Initiation; 04 June 2008

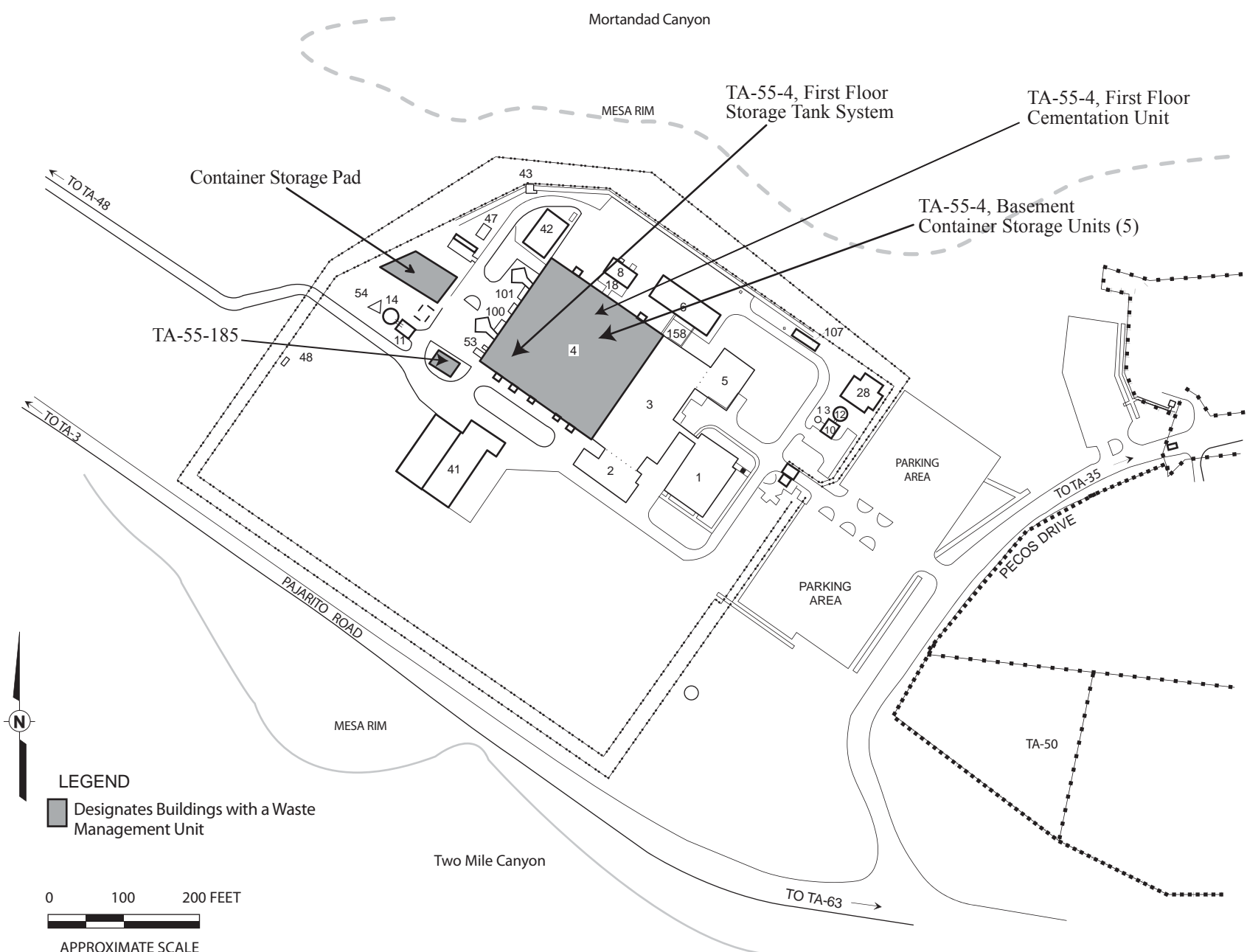

Figure 39
 Technical Area (TA) 55, Building 4 Location Map

(FIGURE 40 - TA-55, BUILDING 4, ROOM B40)

UCNI

LOS ALAMOS NATIONAL LABORATORY

**THIS FIGURE CONTAINS UNCLASSIFIED CONTROLLED NUCLEAR
INFORMATION (UCNI) AS DEFINED BY SECTION 148 OF THE ATOMIC ENERGY
ACT**

(FIGURE 41 - TA-55, BUILDING 4, ROOM K13)

UCNI

LOS ALAMOS NATIONAL LABORATORY

**THIS FIGURE CONTAINS UNCLASSIFIED CONTROLLED NUCLEAR
INFORMATION (UCNI) AS DEFINED BY SECTION 148 OF THE ATOMIC ENERGY
ACT**

(FIGURE 42 - TA-55, BUILDING 4, ROOM B05)

UCNI

LOS ALAMOS NATIONAL LABORATORY

**THIS FIGURE CONTAINS UNCLASSIFIED CONTROLLED NUCLEAR
INFORMATION (UCNI) AS DEFINED BY SECTION 148 OF THE ATOMIC ENERGY
ACT**

(FIGURE 43 - TA-55, BUILDING 4, ROOM B45)

UCNI

LOS ALAMOS NATIONAL LABORATORY

**THIS FIGURE CONTAINS UNCLASSIFIED CONTROLLED NUCLEAR
INFORMATION (UCNI) AS DEFINED BY SECTION 148 OF THE ATOMIC ENERGY
ACT**

(FIGURE 44 - TA-55, BUILDING 4, VAULT)

UCNI

LOS ALAMOS NATIONAL LABORATORY

**THIS FIGURE CONTAINS UNCLASSIFIED CONTROLLED NUCLEAR
INFORMATION (UCNI) AS DEFINED BY SECTION 148 OF THE ATOMIC ENERGY
ACT**

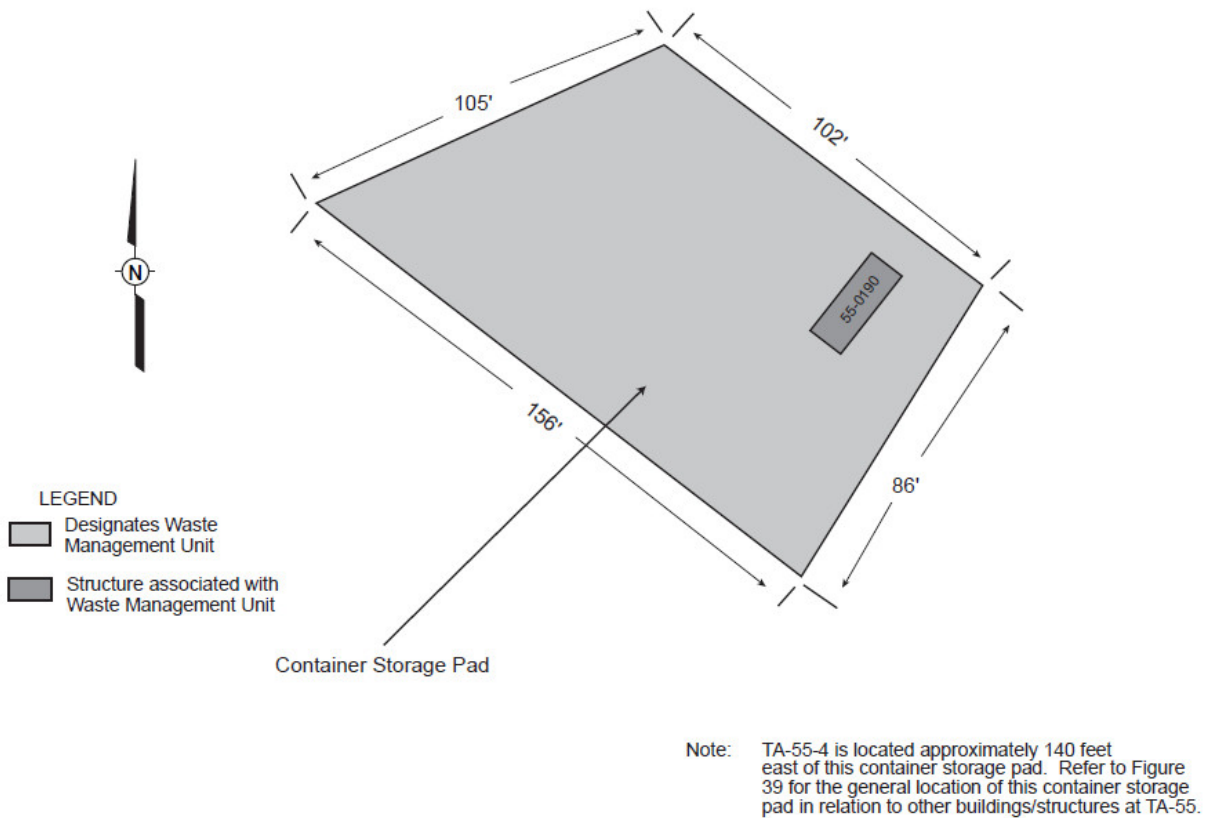
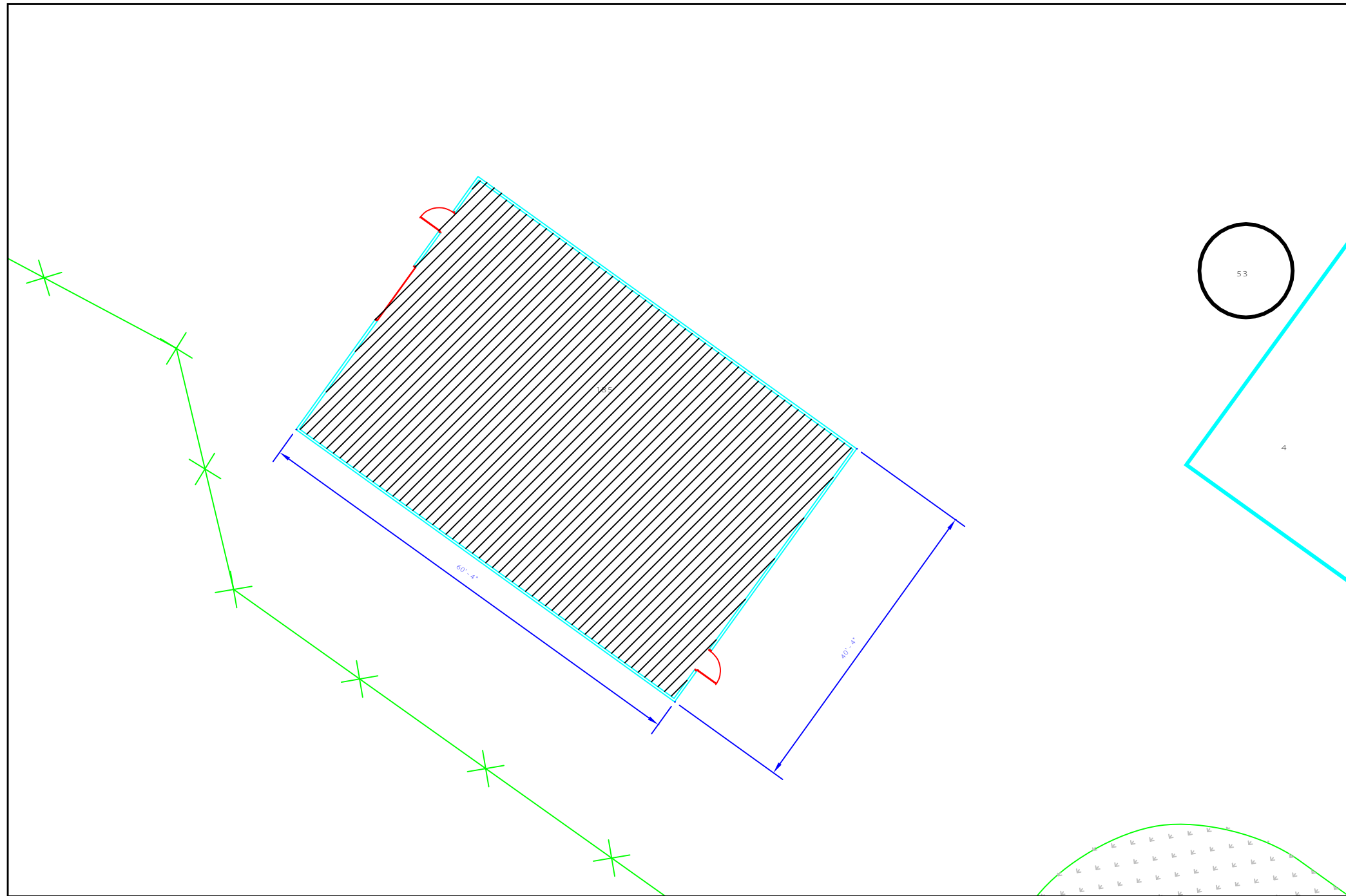
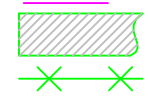

Figure 45
 Technical Area (TA)-55, Building 4, Outdoor Container Storage Pad



LEGEND



CONTAINER STORAGE UNIT
CHAIN LINK SECURITY FENCE

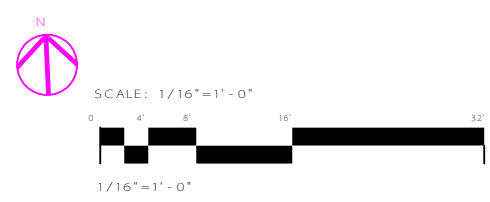
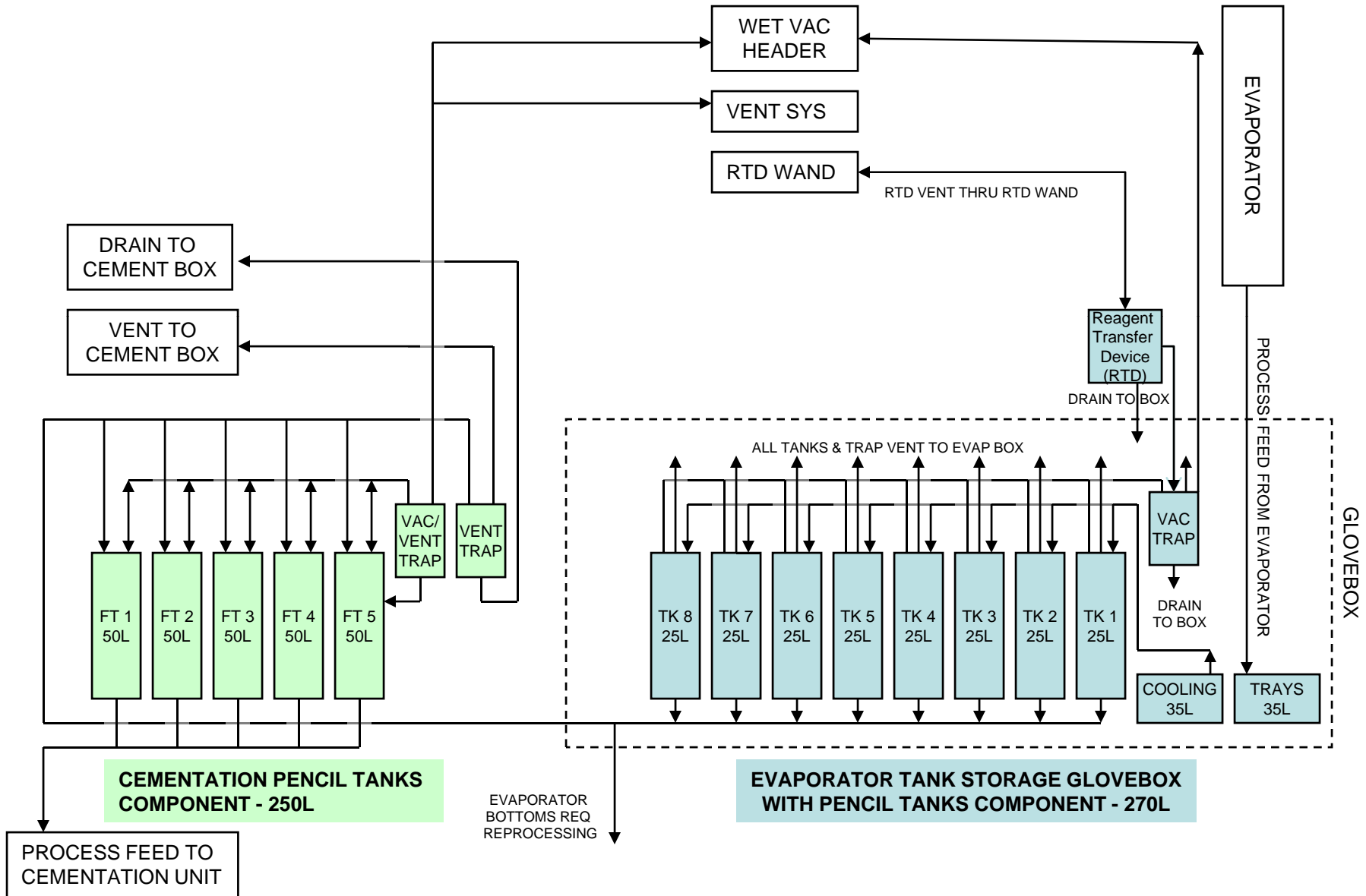

Figure 46
Technical Area (TA)-55, Building 185

Figure 47: TA-55, Building 4, Room 401, Storage Tank System Process Flow Diagram



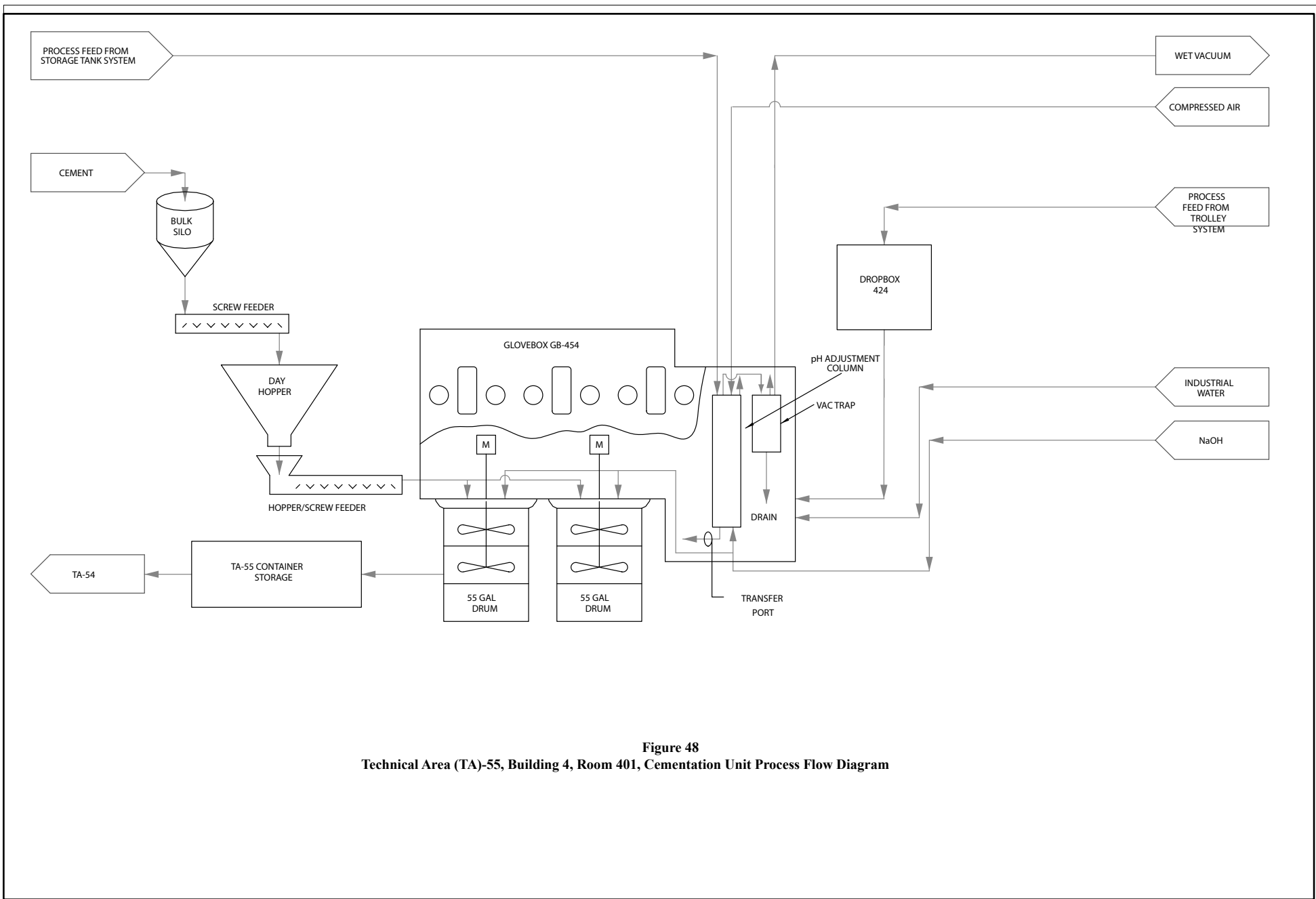

Figure 48
 Technical Area (TA)-55, Building 4, Room 401, Cementation Unit Process Flow Diagram

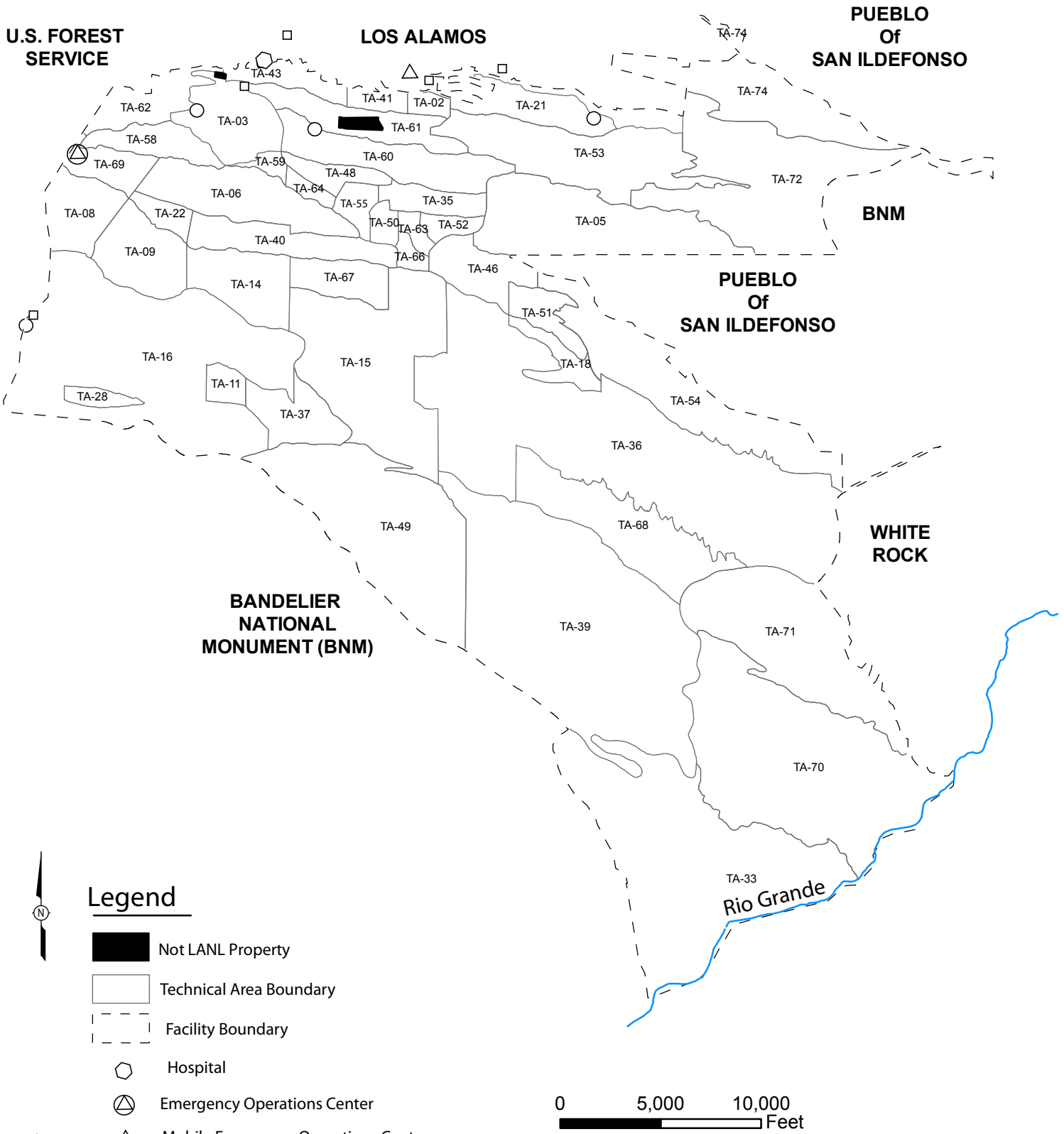
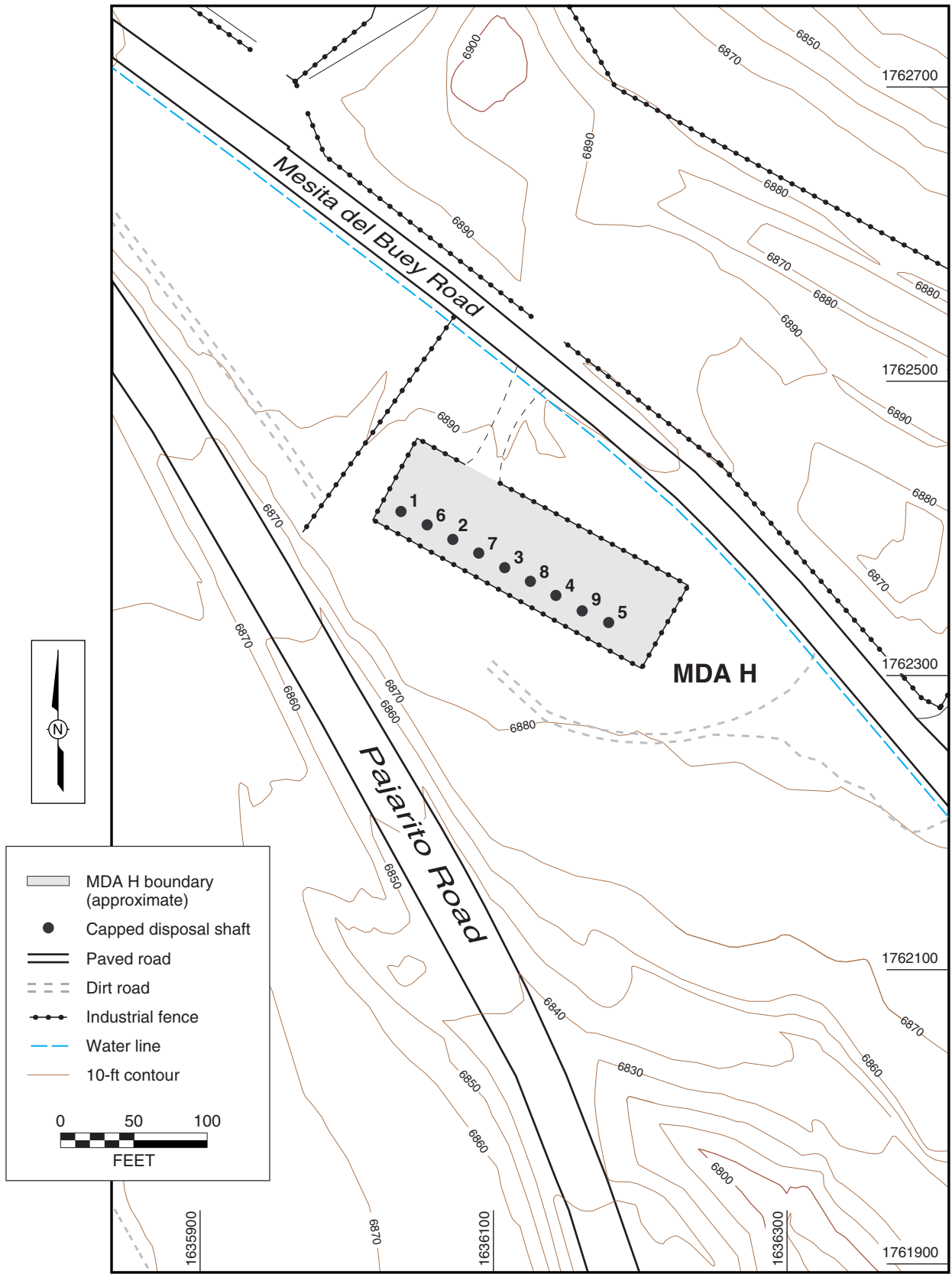

Figure 49:
Emergency Facilities at Los Alamos National Laboratory (LANL)



F1.0-2, MDA H CMS, 052003, cf

Figure 50:
 Technical Area (TA)-54, Material Disposal Area (MDA) H

FIGURE 51 – RESERVED

FIGURE 52 – RESERVED

FIGURE 53 – RESERVED

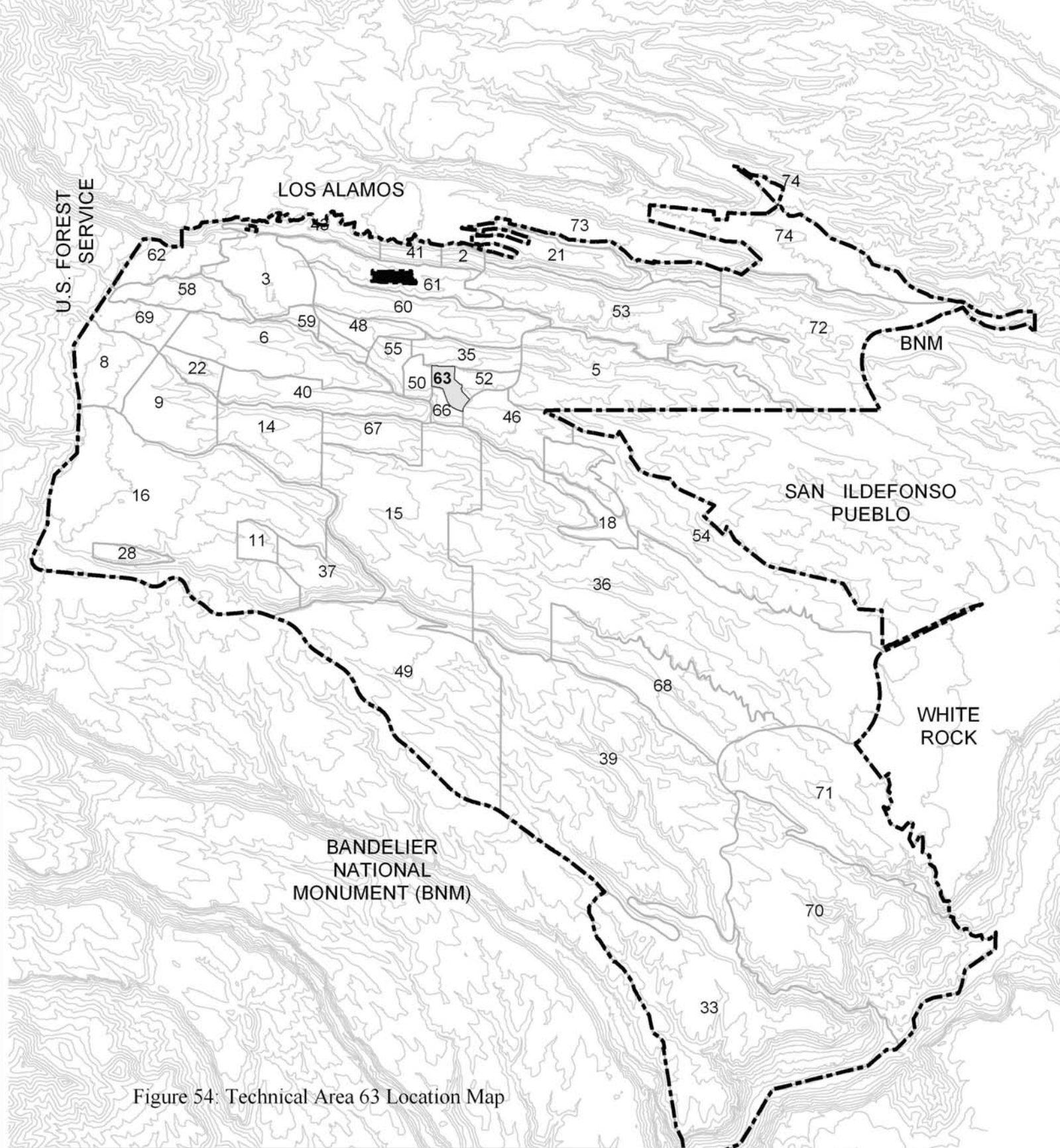







Figure 54: Technical Area 63 Location Map

Location of TA-63 at Los Alamos National Laboratory

-  Not LANL property
-  LANL boundary
-  TA-63
-  Technical Area boundary (2010-08-13)
-  Contours, 100 ft



TA-63









TWF Permitted Unit

KEYED NOTES:

- ① Vehicle entrance via north gate
- ② Vehicle exit via south gate.
- ③ Personnel entry and exit will be via Operations Building 63-0144

FIGURE 55.

Technical Area (TA) 63 Transuranic Waste Facility

-  Regional Well
-  TWF Security Fence
-  Valley Gutter
-  Vehicle Barrier
-  Existing Buildings/Structures
-  TWF Building and Structures
-  TWF Permitted Unit
-  TWF Site boundary

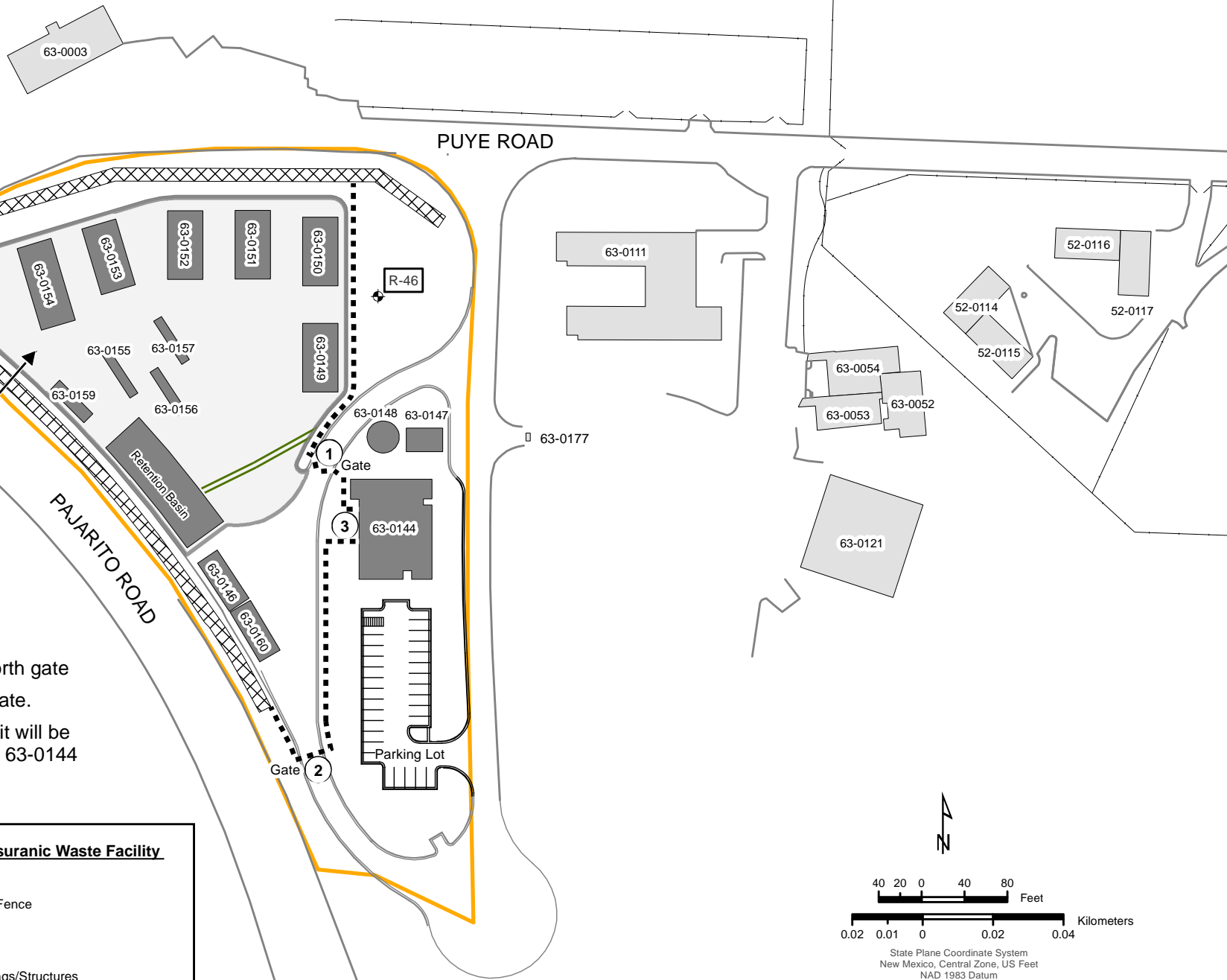

Map Produced by: J. Stockum, Date: 18 June, 2014,
 Map Reference Number: 14-0051
 This map was created for RCRA TWF permit. All other uses for this map
 should be confirmed with LANL ENV-RCRA staff.

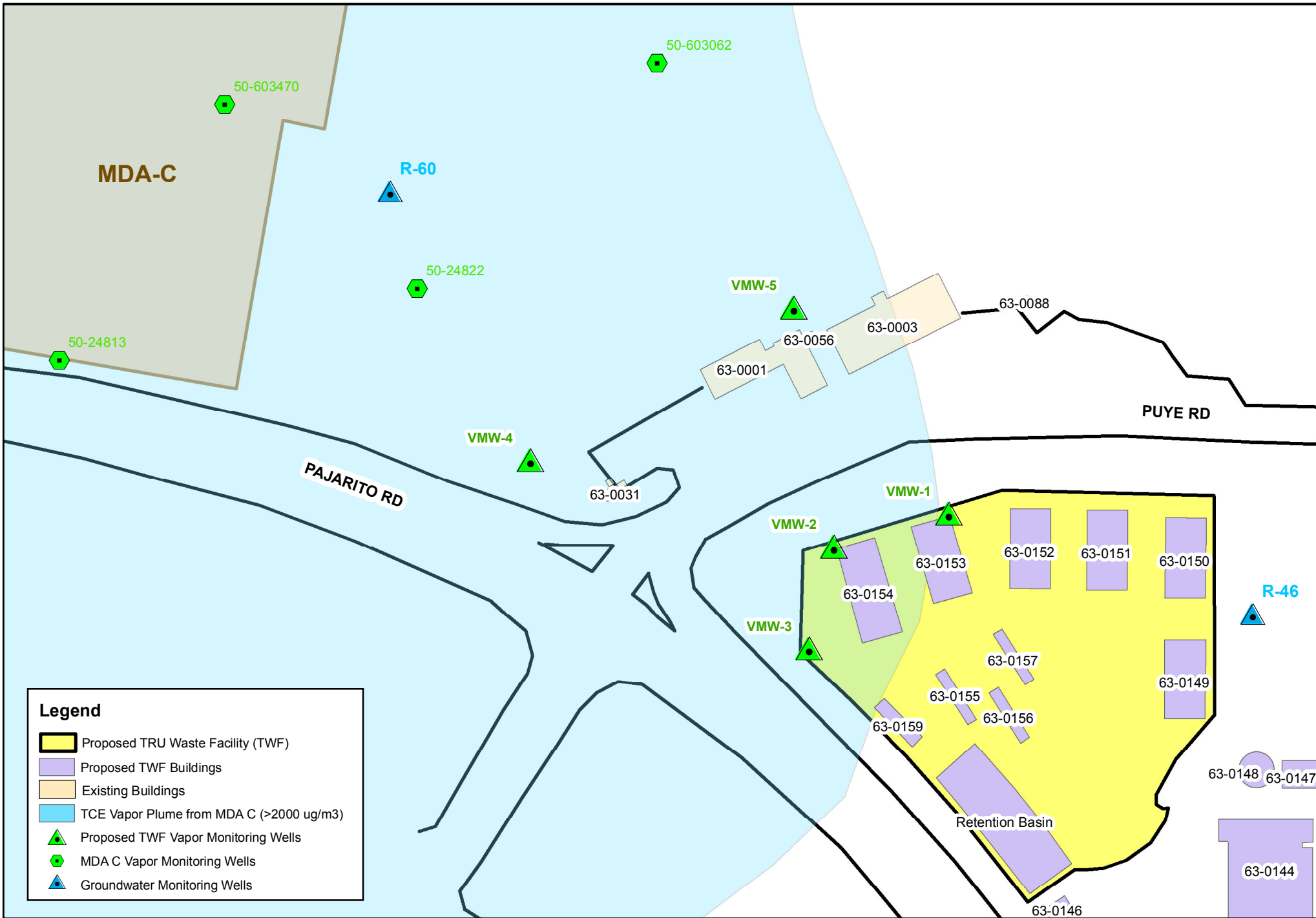

Figure 56

Transuranic Waste Facility Subsurface Vapor Monitoring Network

